



Service Manual

GREE ELECTRIC APPLIANCES, INC. OF ZHUHAI



Table of Contents

Part I : Technical Information	2
1. Summary	2
2. Specifications	3
2.1 Specification Sheet.....	3
2.2 Capacity Variation Ratio According to Temperature	9
2.3 Cooling and Heating Data Sheet in Rated Frequency.....	9
3. Outline Dimension Diagram	11
3.1 Indoor Unit.....	11
3.2 Outdoor Unit.....	12
4. Refrigerant System Diagram	13
5. Electrical Part	14
5.1 Wiring Diagram	14
5.2 PCB Printed Diagram	16
6. Function and Control	19
6.1 Remote Controller Introduction	19
6.2 GREE+ App Operation Manual	24
6.3 Ewpe Smart App Operation Manual.....	25
6.4 Brief Description of Models and Functions.....	26
Part II : Installation and Maintenance	29
7. Notes for Installation and Maintenance	29
8. Installation	35
8.1 Installation Dimension Diagram.....	35
8.2 Installation Parts-checking	37
8.3 Selection of Installation Location.....	37
8.4 Electric Connection Requirement	37
8.5 Installation of Indoor Unit.....	38

8.6 Installation of Outdoor unit.....	40
8.7 Vacuum Pumping and Leak Detection.....	41
8.8 Check after Installation and Test operation.....	42
9. Maintenance.....	43
9.1 Error Code List.....	43
9.2 Procedure of Troubleshooting	48
9.3 Troubleshooting for Normal Malfunction	60
10. Exploded View and Parts List	62
10.1 Indoor Unit.....	62
10.2 Outdoor Unit	64
11. Removal Procedure	68
11.1 Removal Procedure of Indoor Unit.....	68
11.2 Removal Procedure of Outdoor Unit.....	73
Appendix	84
Appendix 1: Reference Sheet of Celsius and Fahrenheit.....	84
Appendix 2: Configuration of Connection Pipe	84
Appendix 3: Pipe Expanding Method.....	85
Appendix 4: List of Resistance for Temperature Sensor.....	86

1. Summary

Indoor Unit:

A1



A3

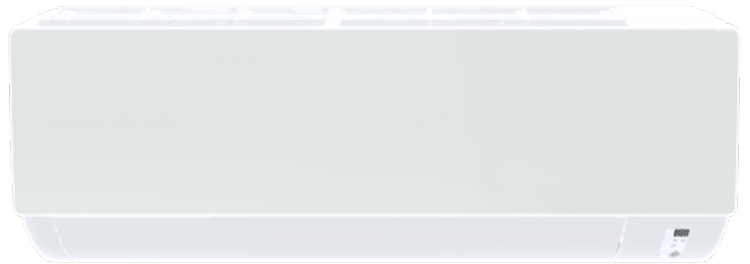

Outdoor Unit:

GWH09APAXE-K6DNA3A/O

GWH12APAXE-K6DNA3A/O

GWH18APAXH-K6DNA3A/O

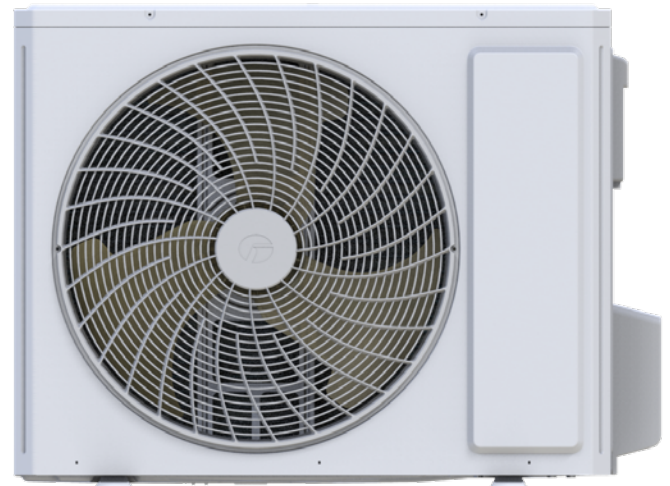
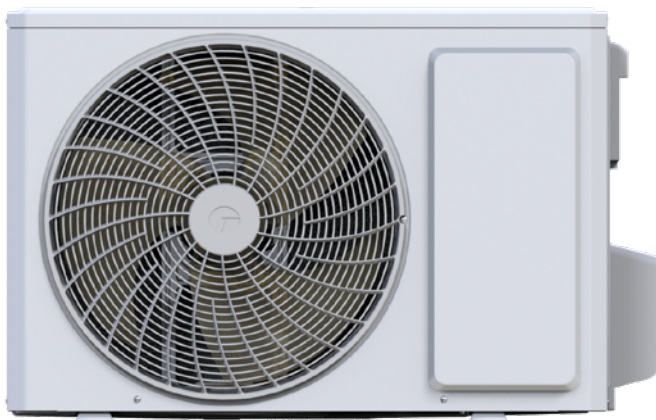

Remote Controller:

YBE1FB6



Model list:

Model	Product code	Indoor model	Indoor product code	Outdoor model	Outdoor product code
GWH09APAXE-K6DNA3A	CB583000200	GWH09APAXE-K6DNA3A/I	CB583N00200	GWH09APAXE-K6DNA3A/O	CB583W00200
GWH09APAXE-K6DNA3A	CB583000201	GWH09APAXE-K6DNA3A/I	CB583N00201		
GWH09APAXE-K6DNA1B	CB552000900	GWH09APAXE-K6DNA1B/I	CB552N00900		
GWH09APAXE-K6DNA1B	CB552000901	GWH09APAXE-K6DNA1B/I	CB552N00901	GWH12APAXE-K6DNA3A/O	CB583W00100
GWH12APAXE-K6DNA3A	CB583000100	GWH12APAXE-K6DNA3A/I	CB583N00100		
GWH12APAXE-K6DNA3A	CB583000101	GWH12APAXE-K6DNA3A/I	CB583N00101		
GWH12APAXE-K6DNA1B	CB552001100	GWH12APAXE-K6DNA1B/I	CB552N01100	GWH18APAXH-K6DNA3A/O	CB583W00300
GWH12APAXE-K6DNA1B	CB552001101	GWH12APAXE-K6DNA1B/I	CB552N01101		
GWH18APAXH-K6DNA3A	CB583000300	GWH18APAXH-K6DNA3A/I	CB583N00300		
GWH18APAXH-K6DNA3A	CB583000301	GWH18APAXH-K6DNA3A/I	CB583N00301	GWH18APAXH-K6DNA1A/O	CB583W00100
GWH18APAXH-K6DNA1A	CB552001000	GWH18APAXH-K6DNA1A/I	CB552N01000		
GWH18APAXH-K6DNA1A	CB552001001	GWH18APAXH-K6DNA1A/I	CB552N01001		

2. Specifications

2.1 Specification Sheet

Model			GWH09APAXE-K6DNA3A	GWH09APAXE-K6DNA1B
Product Code			CB583000200/CB583000201	CB552000900/CB552000901
Power Supply	Rated Voltage	V~	220-240	
	Rated Frequency	Hz	50	
	Phases		1	
Power Supply Mode			Outdoor	
Cooling Capacity		W	2700	
Heating Capacity		W	3600	
Cooling Power Input		W	515	
Heating Power Input		W	720	
Cooling Current Input		A	2.7	
Heating Current Input		A	3.7	
Rated Input		W	1600	
Rated Cooling Current		A	6	
Rated Heating Current		A	7.5	
Air Flow Volume		m ³ /h	800/650/600/500/400/300/250/180	
Dehumidifying Volume		L/h	0.8	
EER		W/W	5.24	
COP		W/W	5	
SEER		W/W	9.7	
SCOP(Average/Warmer/Colder)		W/W	5.1/6.3/4.0	
Application Area		m ²	12-18	
Indoor Unit	Model		GWH09APAXE-K6DNA3A/I	GWH09APAXE-K6DNA1B/I
	Product Code		CB583N00200/CB583N00201	CB552N00900/CB552N00901
	Fan Type		Cross-flow	
	Fan Diameter Length(DXL)	mm	Φ108×592	
	Cooling Speed	r/min	1100/1000/950/800/750/650/600/500	
	Heating Speed	r/min	1300/1100/950/900/850/800/700	
	Fan Motor Power Output	W	15	
	Fan Motor RLA	A	0.22	
	Fan Motor Capacitor	μF	/	
	Evaporator Form		Aluminum Fin-copper Tube	
	Evaporator Pipe Diameter	mm	Φ7	
	Evaporator Row-fin Gap	mm	2-1.3	
	Evaporator Coil Length (LXDXW)	mm	607×25.4×342.9	
	Swing Motor Model		MP35CJ/MP24HF	
	Swing Motor Power Output	W	2.5/1.5	
	Fuse Current	A	3.15	
	Sound Pressure Level	dB (A)	Cooling:42/38/36/32/29/26/23/21 Heating:45/41/36/34/32/30/27	
	Sound Power Level	dB (A)	Cooling:57/53/51/47/44/41/38/36 Heating:58/54/49/47/45/43/40	
	Dimension (WXHXD)	mm	770X290X230	
	Dimension of Carton Box (LXWXH)	mm	852X377X320	826X354X285
Dimension of Package (LXWXH)	mm	855X380X335	831X370X296	
Net Weight	kg	11	10	
Gross Weight	kg	13.5	11.5	

Outdoor Unit	Outdoor Unit Model		GWH09APAXE-K6DNA3A/O
	Outdoor Unit Product Code		CB583W00200
	Compressor Manufacturer		Shanghai Highly Electrical Appliances Co.,Ltd.
	Compressor Model		GSD098XKUA7JL6B
	Compressor Oil		ACS-68R or equivalent 320±20ml
	Compressor Type		Rotary
	Compressor LRA.	A	/
	Compressor RLA	A	6.8
	Compressor Power Input	W	784
	Compressor Overload Protector		/
	Throttling Method		Electron expansion valve
	Set Temperature Range	°C	8~30
	Cooling Operation Ambient Temperature Range	°C	-18~43
	Heating Operation Ambient Temperature Range	°C	-30~24
	Condenser Form		Aluminum Fin-copper Tube
	Condenser Pipe Diameter	mm	Φ7.94
	Condenser Rows-fin Gap	mm	2-1.4
	Condenser Coil Length (LXDXW)	mm	865×38.1×528
	Fan Motor Speed	rpm	850
	Fan Motor Power Output	W	40
	Fan Motor RLA	A	0.5
	Fan Motor Capacitor	μF	/
	Outdoor Unit Air Flow Volume	m ³ /h	3000
	Fan Type		Axial-flow
	Fan Diameter	mm	445
	Defrosting Method		Automatic Defrosting
	Climate Type		T1
	Isolation		I
	Moisture Protection		IPX4
	Permissible Excessive Operating Pressure for the Discharge Side	MPa	4.3
	Permissible Excessive Operating Pressure for the Suction Side	MPa	2.5
	Sound Pressure Level (H/M/L)	dB (A)	56
	Sound Power Level (H/M/L)	dB (A)	65
Dimension(WXHXD)	mm	873X555X376	
Dimension of Carton Box (LXWXH)	mm	948X428X591	
Dimension of Package(LXWXH)	mm	951X431X620	
Net Weight	kg	36	
Gross Weight	kg	39	
Refrigerant		R32	
Refrigerant Charge	kg	1	
Connection Pipe	Connection Pipe Length	m	5
	Connection Pipe Gas Additional Charge	g/m	16
	Outer Diameter Liquid Pipe		1/4"
	Outer Diameter Gas Pipe		3/8"
	Max Distance Height	m	10
	Max Distance Length	m	15
Note: The connection pipe applies metric diameter.			

The above data is subject to change without notice. Please refer to the nameplate of the unit.

Model			GWH12APAXE-K6DNA3A	GWH12APAXE-K6DNA1B
Product Code			CB583000100/CB583000101	CB552001100/CB552001101
Power Supply	Rated Voltage	V~	220-240	
	Rated Frequency	Hz	50	
	Phases		1	
Power Supply Mode			Outdoor	
Cooling Capacity		W	3520	
Heating Capacity		W	3800	
Cooling Power Input		W	720	
Heating Power Input		W	810	
Cooling Current Input		A	3.6	
Heating Current Input		A	4	
Rated Input		W	1600	
Rated Cooling Current		A	6.4	
Rated Heating Current		A	7.5	
Air Flow Volume		m ³ /h	830/650/600/500/400/300/250/180	
Dehumidifying Volume		L/h	1.4	
EER		W/W	4.89	
COP		W/W	4.69	
SEER		W/W	9.7	
SCOP(Average/WarmerColder)		W/W	5.1/6.3/4.0	
Application Area		m ²	16-24	
Indoor Unit	Model		GWH12APAXE-K6DNA3A/I	GWH12APAXE-K6DNA1B/I
	Product Code		CB583N00100/CB583N00101	CB552N01100/CB552N01101
	Fan Type		Cross-flow	
	Fan Diameter Length(DXL)	mm	Φ108×592	
	Cooling Speed	r/min	1200/1000/950/800/750/650/600/500	
	Heating Speed	r/min	1300/1100/950/900/850/800/700	
	Fan Motor Power Output	W	15	
	Fan Motor RLA	A	0.22	
	Fan Motor Capacitor	μF	/	
	Evaporator Form		Aluminum Fin-copper Tube	
	Evaporator Pipe Diameter	mm	Φ7	
	Evaporator Row-fin Gap	mm	2-1.3	
	Evaporator Coil Length (LXDXW)	mm	607×25.4×342.9	
	Swing Motor Model		MP35CJ/MP24HF	
	Swing Motor Power Output	W	2.5/1.5	
	Fuse Current	A	3.15	
	Sound Pressure Level	dB (A)	Cooling:42/38/36/34/30/27/23/22 Heating:45/40/36/34/32/29/26	
	Sound Power Level	dB (A)	Cooling:60/53/51/49/45/42/38/37 Heating:60/55/51/49/47/44/41	
	Dimension (WXHXD)	mm	770X290X230	
	Dimension of Carton Box (LXWXH)	mm	852X377X320	826X354X285
Dimension of Package (LXWXH)	mm	855X380X335	831X370X296	
Net Weight	kg	11	10	
Gross Weight	kg	13.5	11.5	

Outdoor Unit	Outdoor Unit Model		GWH12APAXE-K6DNA3A/O
	Outdoor Unit Product Code		CB583W00100
	Compressor Manufacturer		Shanghai Highly Electrical Appliances Co.,Ltd.
	Compressor Model		GSD098XKUA7JL6B
	Compressor Oil		ACS-68R or equivalent 320±20ml
	Compressor Type		Rotary
	Compressor LRA.	A	/
	Compressor RLA	A	6.8
	Compressor Power Input	W	784
	Compressor Overload Protector		/
	Throttling Method		Electron expansion valve
	Set Temperature Range	°C	8~30
	Cooling Operation Ambient Temperature Range	°C	-18~43
	Heating Operation Ambient Temperature Range	°C	-30~24
	Condenser Form		Aluminum Fin-copper Tube
	Condenser Pipe Diameter	mm	Φ7.94
	Condenser Rows-fin Gap	mm	2-1.4
	Condenser Coil Length (LXD _{XW})	mm	865×38.1×528
	Fan Motor Speed	rpm	850
	Fan Motor Power Output	W	40
	Fan Motor RLA	A	0.5
	Fan Motor Capacitor	μF	/
	Outdoor Unit Air Flow Volume	m ³ /h	3000
	Fan Type		Axial-flow
	Fan Diameter	mm	445
	Defrosting Method		Automatic Defrosting
	Climate Type		T1
	Isolation		I
	Moisture Protection		IPX4
	Permissible Excessive Operating Pressure for the Discharge Side	MPa	4.3
	Permissible Excessive Operating Pressure for the Suction Side	MPa	2.5
	Sound Pressure Level (H/M/L)	dB (A)	56
	Sound Power Level (H/M/L)	dB (A)	65
Dimension(WXHXD)	mm	873X555X376	
Dimension of Carton Box (LXWXH)	mm	948X428X591	
Dimension of Package(LXWXH)	mm	951X431X620	
Net Weight	kg	36	
Gross Weight	kg	39	
Refrigerant		R32	
Refrigerant Charge	kg	1	
Connection Pipe	Connection Pipe Length	m	5
	Connection Pipe Gas Additional Charge	g/m	16
	Outer Diameter Liquid Pipe		1/4"
	Outer Diameter Gas Pipe		3/8"
	Max Distance Height	m	10
	Max Distance Length	m	15
Note: The connection pipe applies metric diameter.			

The above data is subject to change without notice. Please refer to the nameplate of the unit.

Model			GWH18APAXH-K6DNA3A	GWH18APAXH-K6DNA1A	
Product Code			CB583000300/CB583000301	CB552001000/CB552001001	
Power Supply	Rated Voltage	V~	220-240		
	Rated Frequency	Hz	50		
	Phases		1		
Power Supply Mode			Outdoor		
Cooling Capacity		W	5300		
Heating Capacity		W	5600		
Cooling Power Input		W	1380		
Heating Power Input		W	1450		
Cooling Current Input		A	6.2		
Heating Current Input		A	6.8		
Rated Input		W	2400		
Rated Cooling Current		A	11.5		
Rated Heating Current		A	11.5		
Air Flow Volume		m ³ /h	950/850/760/640/500/420/350		
Dehumidifying Volume		L/h	1.8		
EER		W/W	3.84		
COP		W/W	3.86		
SEER		W/W	7.5		
SCOP(Average/WarmerColder)		W/W	4.3/5.7/3.5		
Application Area		m ²	23-34		
Indoor Unit	Model		GWH18APAXH-K6DNA3A/I	GWH18APAXH-K6DNA1A/I	
	Product Code		CB583N00300/CB583N00301	CB552N01000/CB552N01001	
	Fan Type		Cross-flow		
	Fan Diameter Length(DXL)	mm	Φ108×592		
	Cooling Speed	r/min	1250/1200/1100/1000/900/800/700		
	Heating Speed	r/min	1500/1350/1200/1050/900/850/800		
	Fan Motor Power Output	W	15		
	Fan Motor RLA	A	0.3		
	Fan Motor Capacitor	μF	/		
	Evaporator Form		Aluminum Fin-copper Tube		
	Evaporator Pipe Diameter	mm	Φ7		
	Evaporator Row-fin Gap	mm	2-1.3		
	Evaporator Coil Length (LXDXW)	mm	607×25.4×342.9		
	Swing Motor Model		MP35CJ/MP24HF		
	Swing Motor Power Output	W	2.5/1.5		
	Fuse Current	A	3.15		
	Sound Pressure Level	dB (A)	Cooling:47/45/41/36/33/30/25 Heating:49/46/42/38/34/33/27		
	Sound Power Level	dB (A)	Cooling:60/55/51/46/43/40/35 Heating:60/56/52/48/44/43/37		
	Dimension (WXHXD)	mm	770X290X230		
	Dimension of Carton Box (LXWXH)	mm	852X377X320	826X354X285	
	Dimension of Package (LXWXH)	mm	855X380X335	831X370X296	
Net Weight	kg	11	10.5		
Gross Weight	kg	13.5	12		

Outdoor Unit	Outdoor Unit Model		GWH18APAXH-K6DNA3A/O	
	Outdoor Unit Product Code		CB583W00300	
	Compressor Manufacturer		ZHUHAI LANDA COMPRESSOR CO., LTD	
	Compressor Model		FTz-SM151AXB	
	Compressor Oil		FW68DA or equivalent	
	Compressor Type		Rotary	
	Compressor LRA	A		18
	Compressor RLA	A		6.06
	Compressor Power Input	W		1330
	Compressor Overload Protector			/
	Throttling Method			Electron expansion valve
	Set Temperature Range	°C		8~30
	Cooling Operation Ambient Temperature Range	°C		-18~43
	Heating Operation Ambient Temperature Range	°C		-30~24
	Condenser Form			Aluminum Fin-copper Tube
	Condenser Pipe Diameter	mm		Φ7
	Condenser Rows-fin Gap	mm		2-1.4
	Condenser Coil Length (LXDXW)	mm		955×38.1×704
	Fan Motor Speed	rpm		780
	Fan Motor Power Output	W		90
	Fan Motor RLA	A		0.6
	Fan Motor Capacitor	μF		/
	Outdoor Unit Air Flow Volume	m ³ /h		4000
	Fan Type			Axial-flow
	Fan Diameter	mm		570
	Defrosting Method			Automatic Defrosting
	Climate Type			T1
	Isolation			I
	Moisture Protection			IPX4
	Permissible Excessive Operating Pressure for the Discharge Side	MPa		4.3
	Permissible Excessive Operating Pressure for the Suction Side	MPa		2.5
	Sound Pressure Level (H/M/L)	dB (A)		60
	Sound Power Level (H/M/L)	dB (A)		65
Dimension(WXHXD)	mm		1000X746X427	
Dimension of Carton Box (LXWXH)	mm		1077X480X785	
Dimension of Package(LXWXH)	mm		1080X483X807	
Net Weight	kg		47	
Gross Weight	kg		52	
Refrigerant			R32	
Refrigerant Charge	kg		1.35	
Connection Pipe	Connection Pipe Length	m	5	
	Connection Pipe Gas Additional Charge	g/m	40	
	Outer Diameter Liquid Pipe		1/4"	
	Outer Diameter Gas Pipe		5/8"	
	Max Distance Height	m	10	
	Max Distance Length	m	25	
Note: The connection pipe applies metric diameter.				

The above data is subject to change without notice. Please refer to the nameplate of the unit.

2.2 Capacity Variation Ratio According to Temperature

Cooling

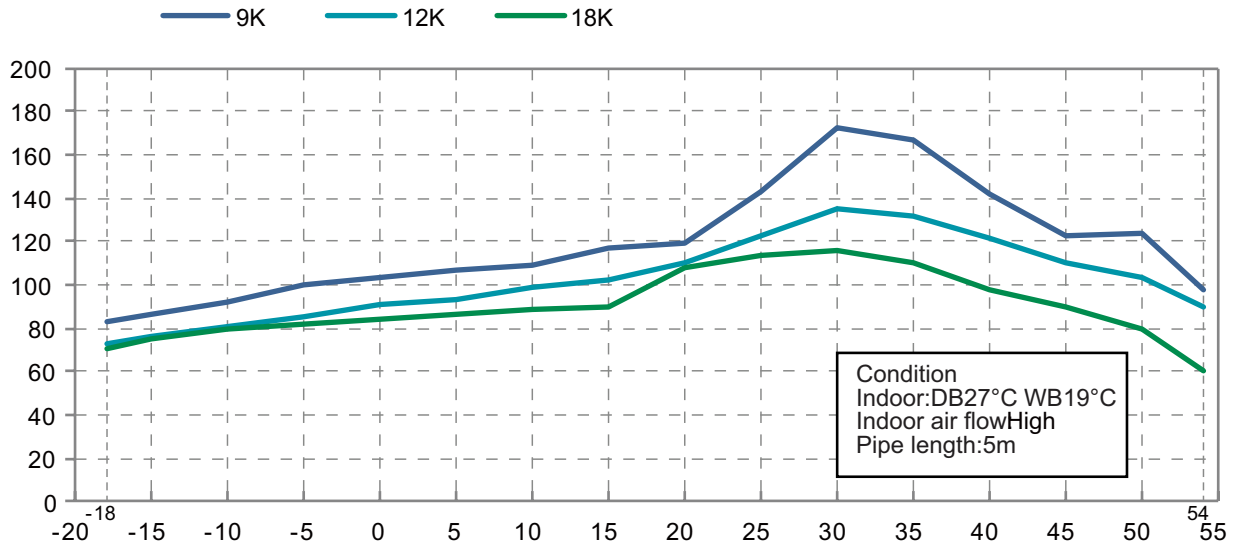

Heating

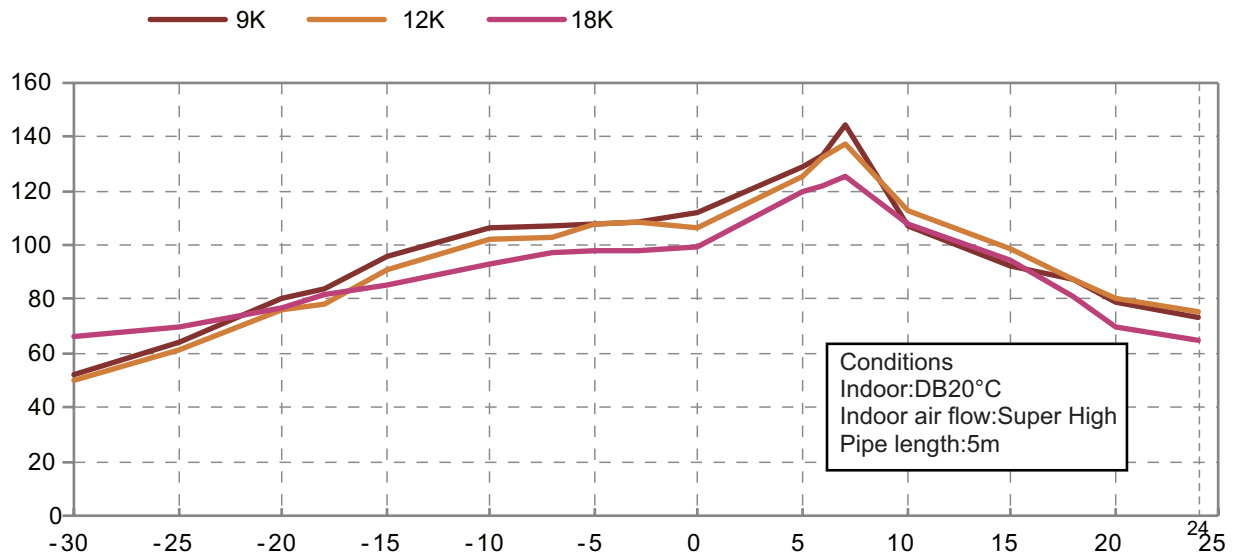

2.3 Cooling and Heating Data Sheet in Rated Frequency

Cooling:

Rated cooling condition(°C) (DB/WB)		Model	Pressure of gas pipe connecting	Inlet and outlet pipe temperature of		Fan speed of indoor unit	Fan speed of outdoor unit
Indoor	Outdoor		indoor and outdoor unit	heat exchanger			
			P (MPa)	T1 (°C)	T2 (°C)		
27/19	35/24	9/12K	0.9~1.1	12 - 15	67 - 37	Super High	High
27/19	35/24	18K	0.9~1.1	12 - 14	75 - 37	Super High	High

Heating:

Rated heating condition(°C) (DB/WB)		Model	Pressure of gas pipe connecting indoor and outdoor unit P (MPa)	Inlet and outlet pipe temperature of heat exchanger		Fan speed of indoor unit	Fan speed of outdoor unit
Indoor	Outdoor			T1 (°C)	T2 (°C)		
20/-	7/6	9K	2.1~2.4	58 -32	2 - 4	Super High	High
20/-	7/6	12K	2.2~2.4	70 -35	2 - 4	Super High	High
20/-	7/6	18K	2.2~2.4	70 - 40	1 - 5	Super High	High

Instruction:

T1: Inlet and outlet pipe temperature of evaporator

T2: Inlet and outlet pipe temperature of condenser

P: Pressure at the side of big valve

Connection pipe length: 5 m.

3. Outline Dimension Diagram

3.1 Indoor Unit

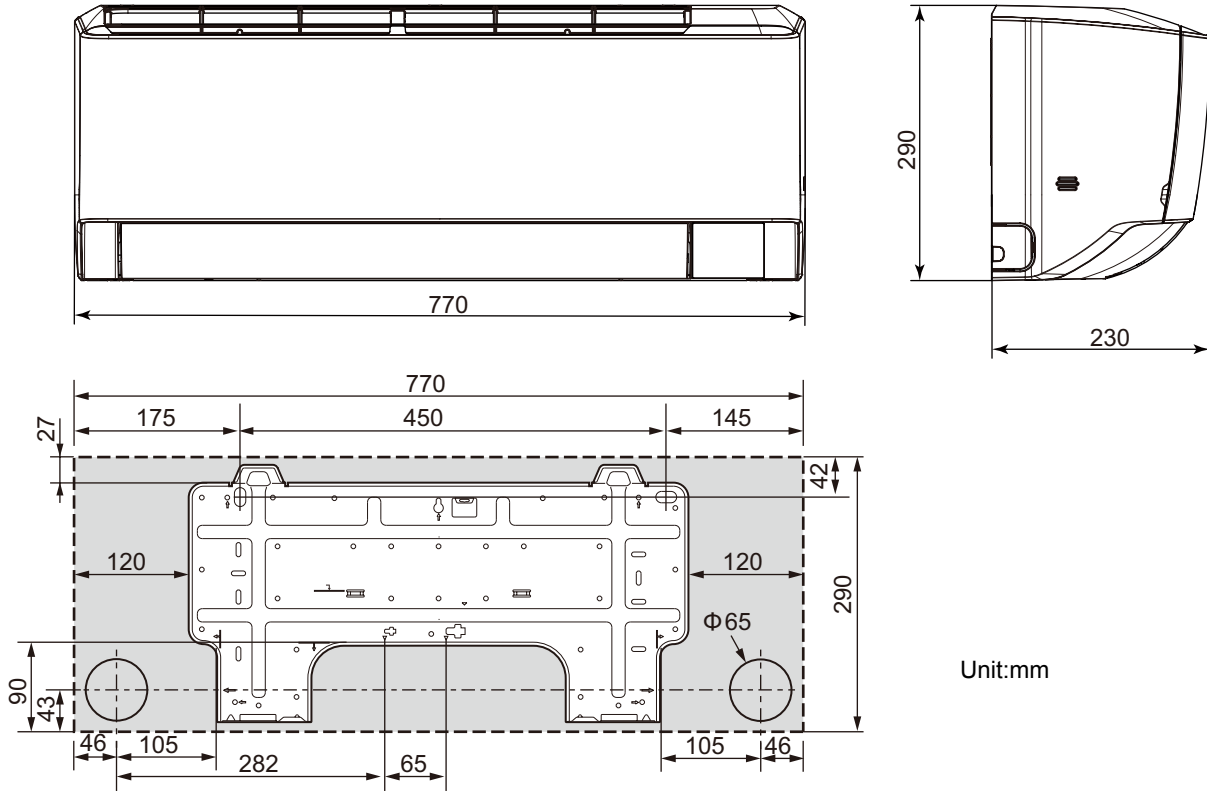

Unit:mm

3.2 Outdoor Unit

GWH09APAXE-K6DNA3A/O GWH12APAXE-K6DNA3A/O

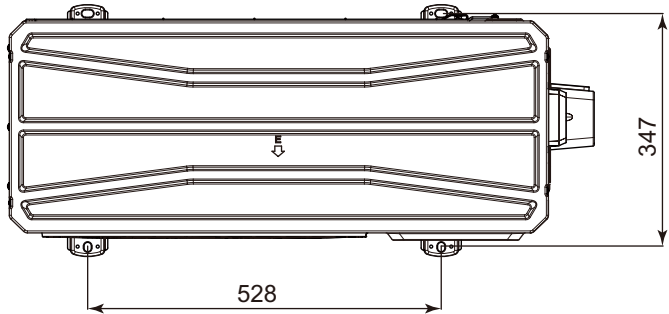
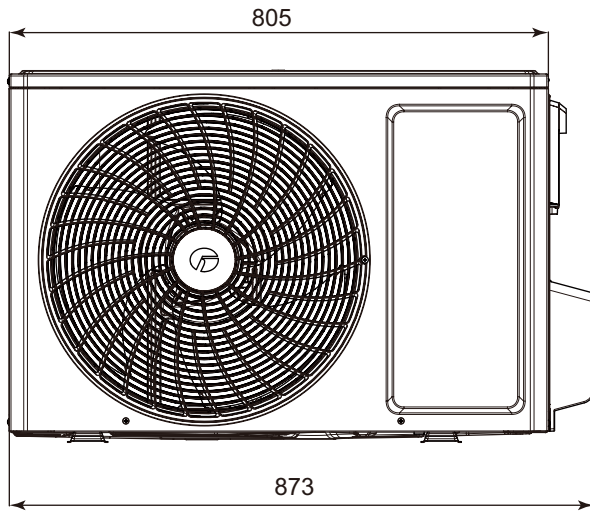
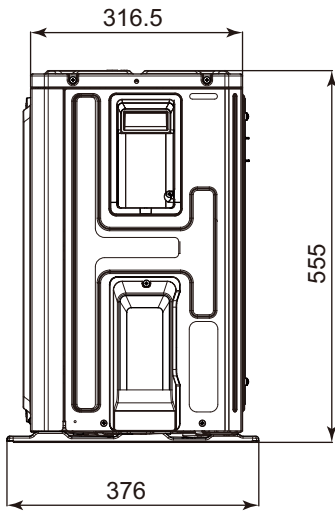

Unit:mm

GWH18APAXH-K6DNA3A/O

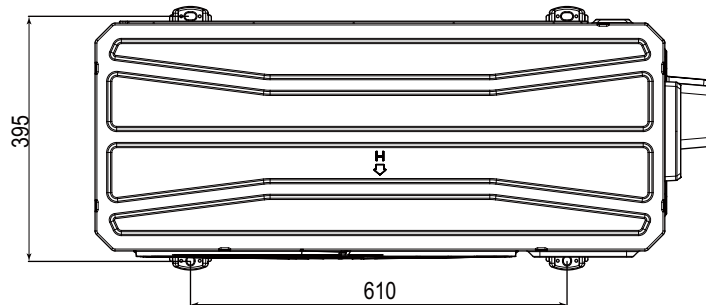
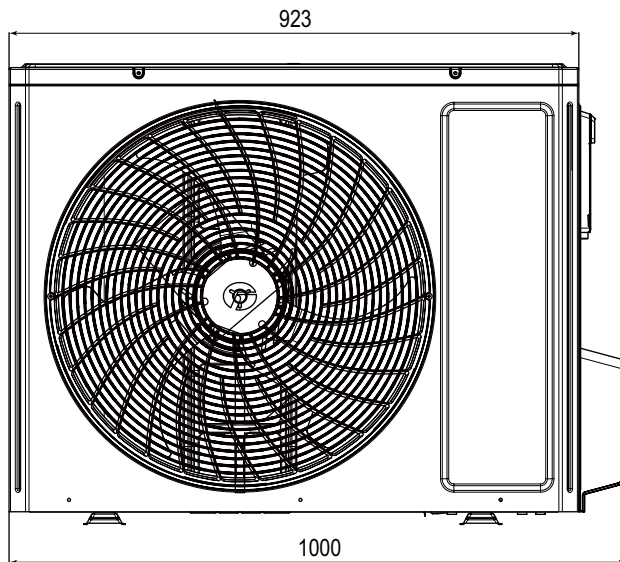
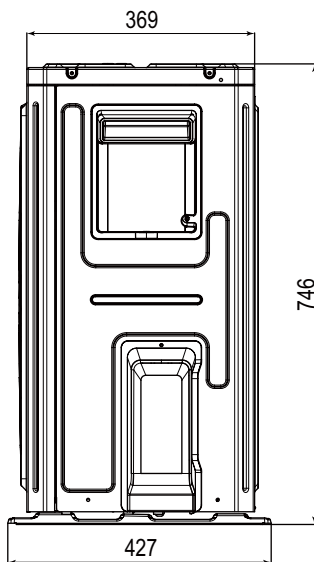

Unit:mm

4. Refrigerant System Diagram

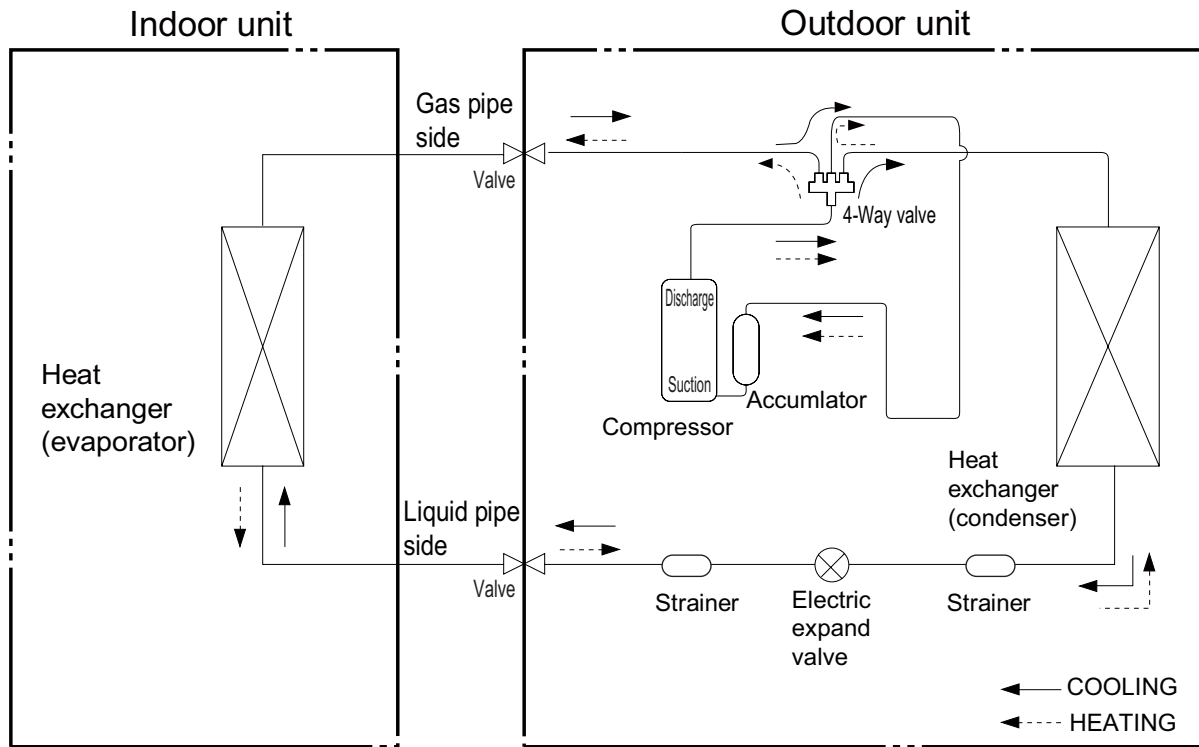

Connection pipe specification:
Liquid pipe: 1/4"
Gas pipe: 3/8" (9/12K), 5/8" (18K)

5. Electrical Part

5.1 Wiring Diagram

•Instruction

Symbol	Symbol Color	Symbol	Symbol Color	Symbol	Name
WH	White	GN	Green	CAP	Jumper cap
YE	Yellow	BN	Brown	COMP	Compressor
RD	Red	BU	Blue		Grounding wire
YEGN	Yellow/Green	BK	Black	/	/
VT	Violet	OG	Orange	/	/

Note: Jumper cap is used to determine fan speed and the swing angle of horizontal lever for this model.

• Indoor Unit

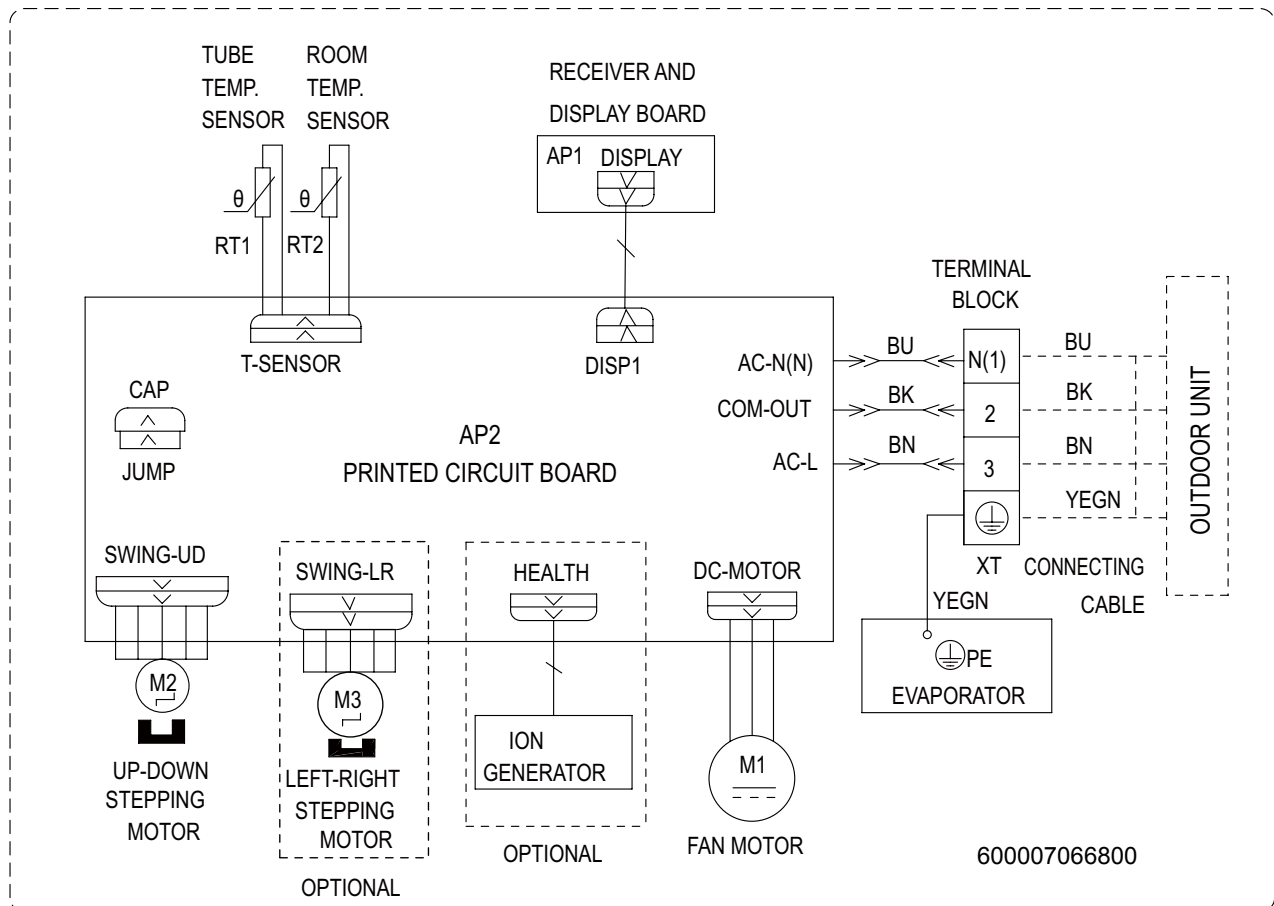

• Outdoor Unit

GWH09APAXE-K6DNA3A/O GWH12APAXE-K6DNA3A/O

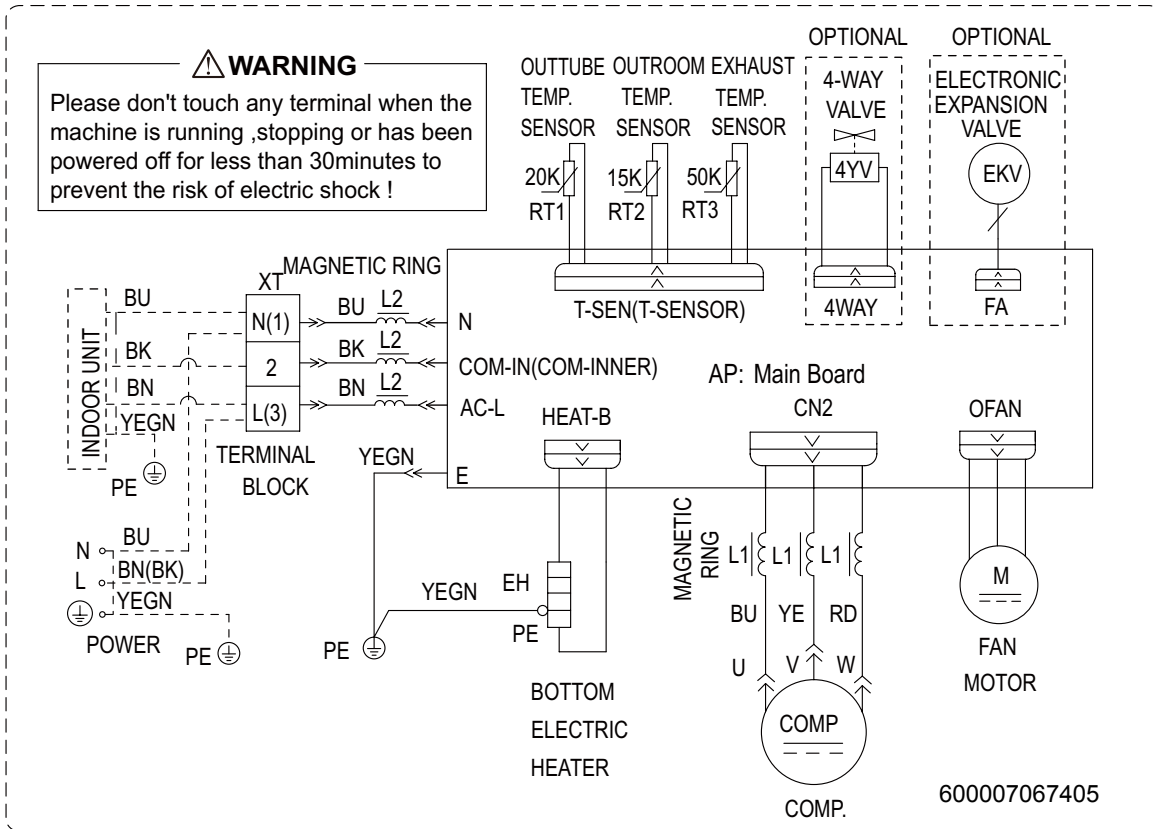

GWH18APAXH-K6DNA3A/O

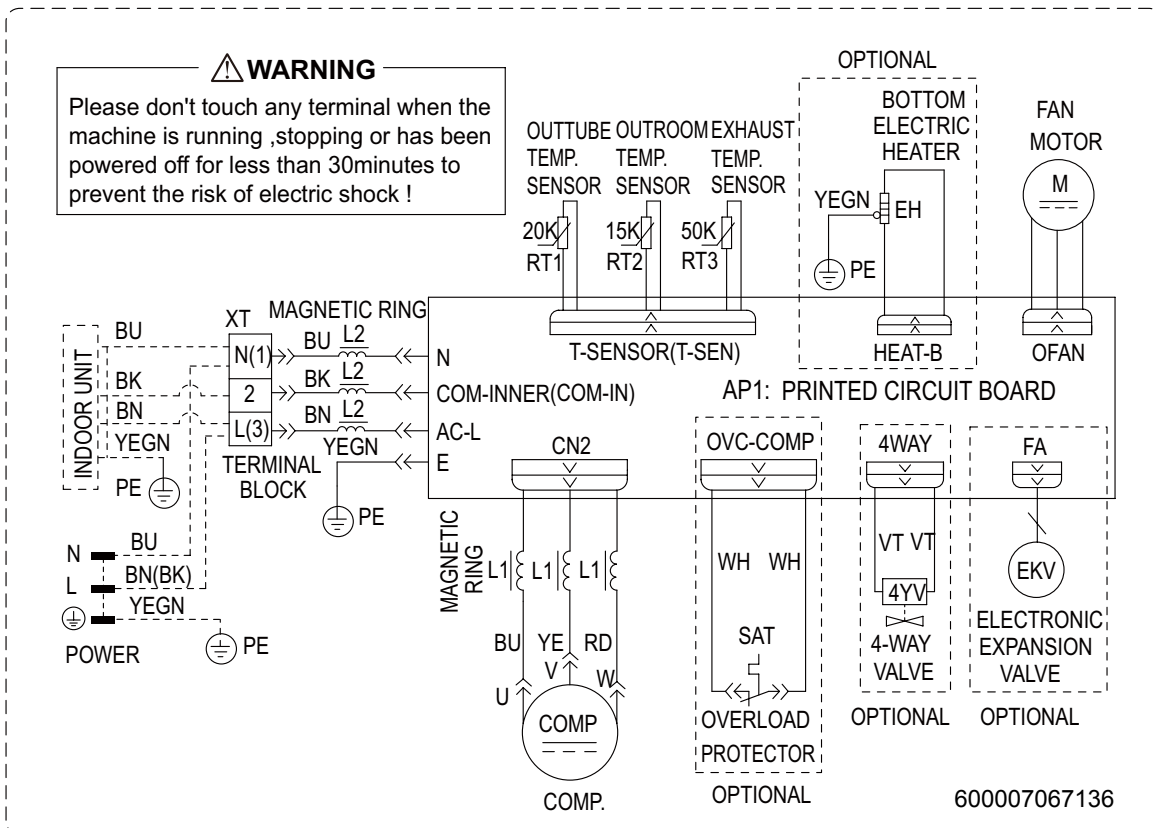

These wiring diagrams are subject to change without notice; please refer to the one supplied with the unit.

Outdoor Unit

GWH09APAXE-K6DNA3A/O GWH12APAXE-K6DNA3A/O

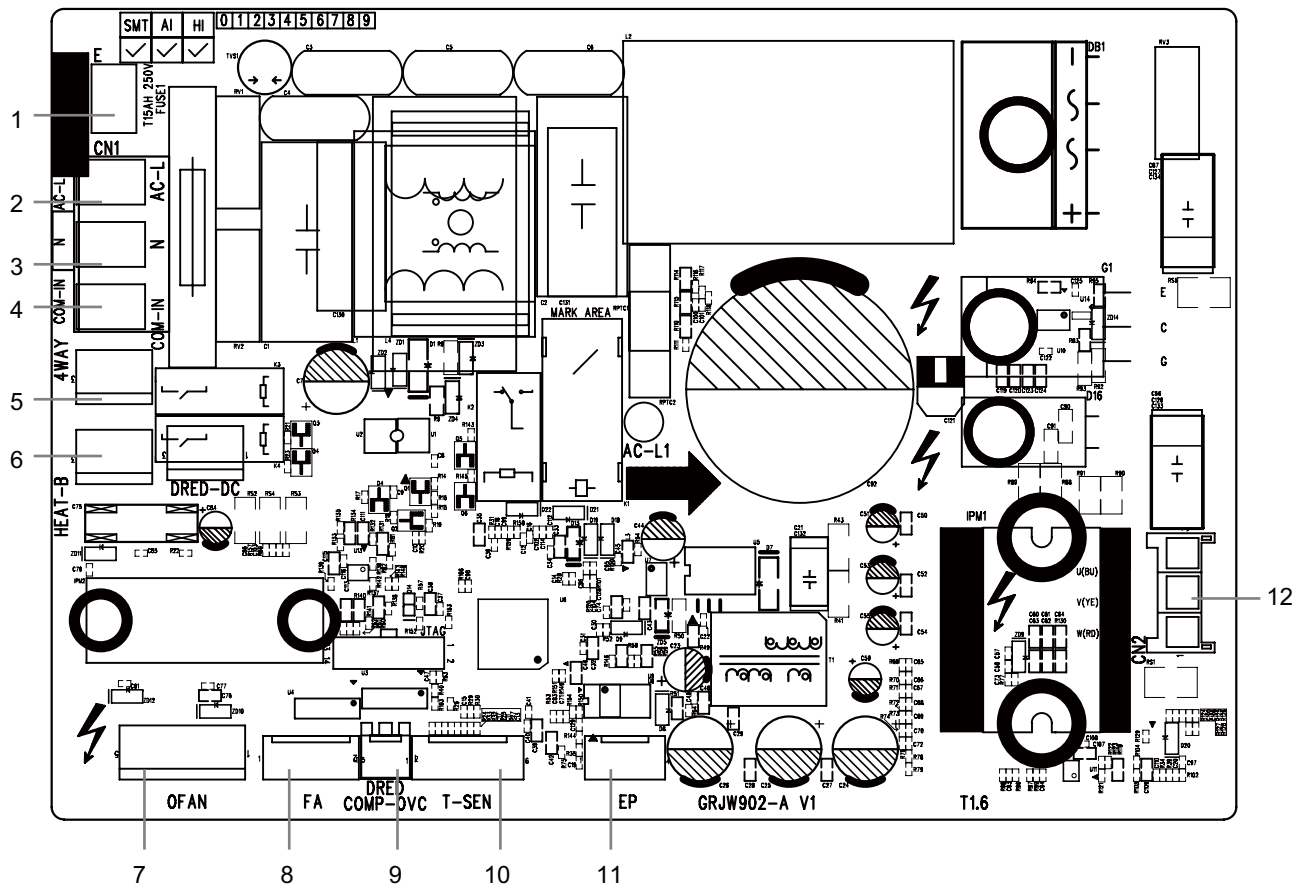

No.	Name
1	Earthing wire
2	Live wire
3	Neutral wire
4	Communication cable
5	4-way valve
6	Electric heating terminal of chassis

No.	Name
7	Outdoor fan
8	Electronic expansion valve
9	Compressor overload terminal
10	Temperature sensor
11	E store terminal
12	Compressor wiring terminal

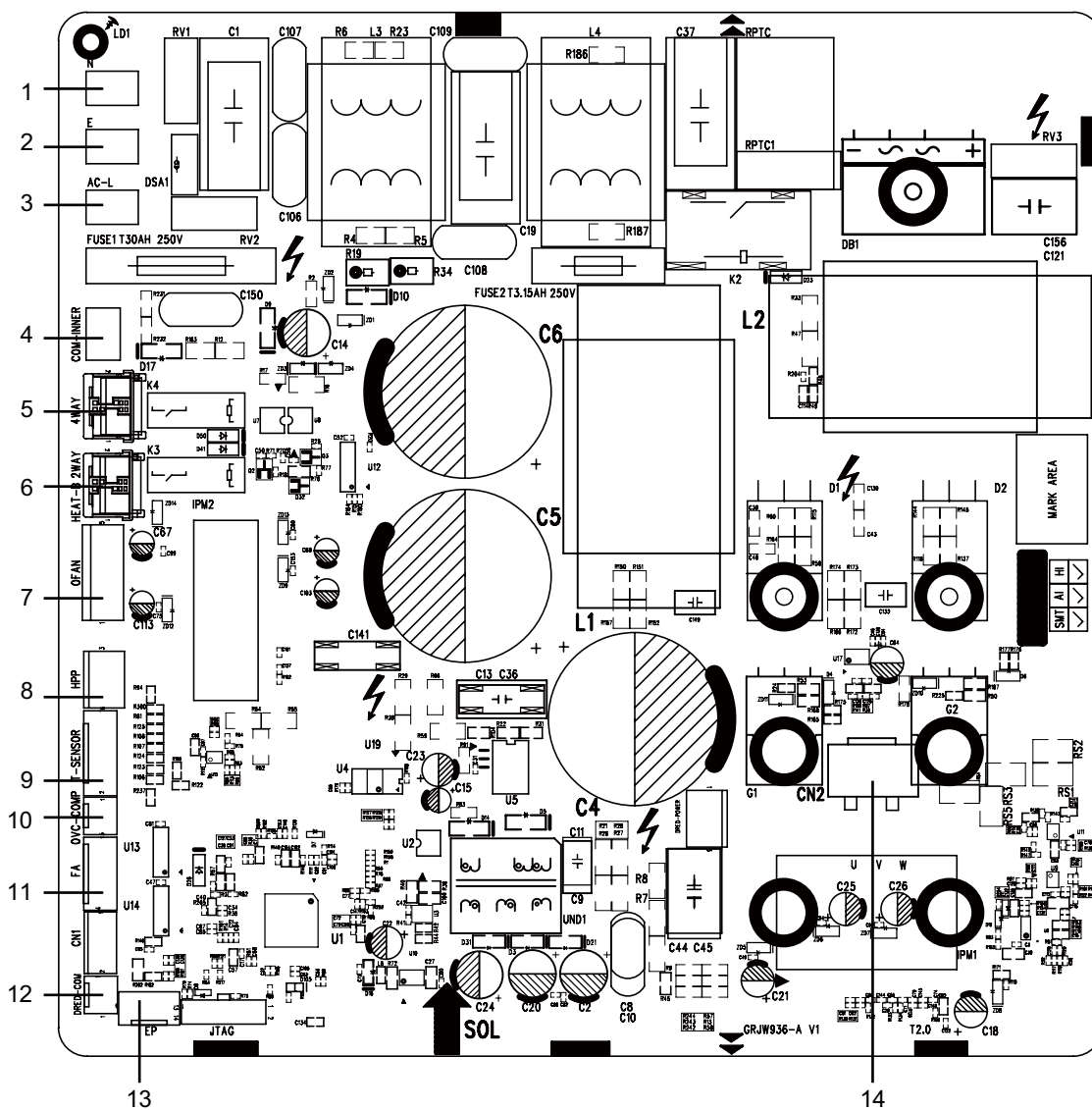

No.	Name	No.	Name
1	Neutral wire	8	Terminal of high pressure protection
2	Grounding wire	9	Temperature sensor
3	Live wire	10	Overload interface of compressor
4	Communication wire	11	Terminal of electronic expansion valve
5	4-way valve	12	Terminal of DRED
6	Electric heating belt of chassis	13	E disk(Reserved)
7	Outdoor fan	14	Terminal of compressor wire

6. Function and Control

6.1 Remote Controller Introduction

NOTE:

- This is a general use remote controller. It could be used for the air conditioner with multifunction. For the functions which the model doesn't have, if press the corresponding button on the remote controller, the unit will keep the original running status.
- After putting through the power, the air conditioner will give out a sound. Operation indicator "ON" is ON. After that, you can operate the air conditioner by using remote controller.
- Under on status, pressing the button on the remote controller, the signal icon "📶" on the display of remote controller will blink once and the air conditioner will give out a "di" sound, which means the signal has been sent to the air conditioner.

Buttons on remote controller



Introduction for icons on display screen

	Send signal	
	Quiet	
	Set fan speed	
	Turbo mode	
Operation mode		Auto mode
		Cool mode
		Dry mode
		Fan mode
		Heat mode
	X-FAN function	
	Humidity control	
	Power limiting operation	
	Set temperature	
	Indoor ambient temp.	
	Indoor ambient humidity	
ON OFF	TIMER ON / TIMER OFF	
	Set time	
	Left & right swing	
	Up & down swing	
	Child lock	
	Fast cool	
	Health function	
	WiFi function	
	LED on	
	Auto LED	
	I feel	
	Sleep mode	

On/Off

Press this button to turn on the unit. Press this button again to turn off the unit.

Mode

Press this button to select your required operation mode.

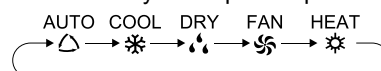









- When selecting auto mode, air conditioner will operate automatically according to the sensed temperature. Press "FAN" button can adjust fan speed. Press "" / "" button can adjust fan blowing angle.
- After selecting cool mode, air conditioner will operate under cool mode. Press "+" or "-" button to adjust set temperature. Press "FAN" button to adjust fan speed. Press "" / "" button to adjust fan blowing angle.
- When selecting dry mode, the air conditioner operates at low speed under dry mode. Under dry mode, fan speed can't be adjusted. Press "" / "" button to adjust fan blowing angle.
- When selecting fan mode, the air conditioner will only blow fan, no cooling and no heating. Press "FAN" button to adjust fan speed. Press "" / "" button to adjust fan blowing angle.
- When selecting heating mode, the air conditioner operates under heat mode. Press "+" or "-" button to adjust set temperature. Press "FAN" button to adjust fan speed. Press ""

" / "  " button to adjust fan blowing angle.



NOTE:

- For preventing cold air, after starting up heat mode, indoor unit will delay 1~5 minutes to blow air (actual delay time depends on indoor ambient temperature).
- Set temperature can be adjusted under AUTO mode.
- Set temperature range from remote controller: 16~30°C (61-86°F). et temperature range from remote controller under HEAT mode :8~30°C (46-86°F).
- This mode indicator is not available for some models.
- Cooling only unit won't receive heating mode signal. If setting heat mode with remote controller, press "  " button can't start up the unit.

Fan

This button is used for setting Fan Speed in the sequence that goes from AUTO,  ,  ,  ,  ,  ,  ,  ,  to  , then back to Auto.

NOTE:

- It's low fan speed under dry mode.
- X-FAN function: Holding fan speed button for 2s in cool or dry mode, the icon "  " is displayed and the indoor fan will continue operation for a few minutes in order to dry the indoor unit even though you have turned off the unit. After energization, X-FAN OFF is defaulted. X-FAN is not available in auto, fan or heat mode.
- This function indicates that moisture on evaporator of indoor unit will be blown after the unit is stopped to avoid mould.
- Having set X-FAN function on: After turning off the unit by pressing ON/OFF button, indoor fan will continue running for a few minutes at low speed. In this period, hold fan speed button for 2s to stop indoor fan directly.
- Having set X-FAN function off: After turning off the unit by pressing "  " button, the complete unit will be off directly.



+/-



Press "+" or "-" button once increase or decrease set temperature 1°C (°F). Holding "+" or "-" button, 2s later, set temperature on remote controller will change quickly. On releasing button after setting is finished, temperature indicator on indoor unit will change accordingly.

NOTE:

- No dual-8 nixie tube for this model; press this button and there is no change for the indicator on the indoor unit.

 Wifi

Press "  " button to turn on WiFi function, "  " icon will be displayed on the remote controller;

Hold "  " button for 5s to turn off WiFi function and "  " icon will disappear.

Under off status, press "Mode" and "  " buttons simultaneously for 1s, WiFi module will restore factory settings.

NOTE:

- This function is applicable to partial of models .

 Health

Press this button to achieve the on and off of health and scavenging functions in operation station. the circulation change is as follow:

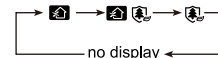





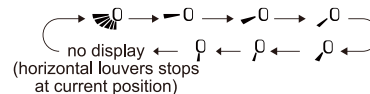

NOTE:

- This mode indicator is not available for some models.



 UD-swing

Press this button can select up & down swing angle. Fan blow angle can be selected circularly as below:



- When selecting "  ", air conditioner is blowing fan automatically. Horizontal louver will automatically swing up & down at maximum angle.
- When selecting "  ,  ,  ,  ", air conditioner is blowing fan at fixed position. Horizontal louver will stop at the fixed position.
- Hold "  " button above 2s to set your required swing angle. When reaching your required angle, release the button.

NOTE:



- Press this button continuously for more than 2s, the main unit will swing back and forth from up to down, and then loosen the button, the unit present position of guide louver will be kept immediately.
- Under up and down swing mode, when the status is switched from off to "  ", if press this button again 2s later, "  "status will switch to off status directly; if press this button again within 2s, the change of swing status will also depend on the circulation sequence stated above.

 LR-swing

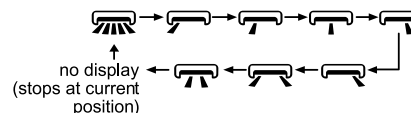
Press this button can select left & right swing angle. Fan blow angle can be selected circularly as below:



NOTE:

- Press this button continuously more than 2s, the main unit will swing back and forth from left to right, and then loosen the button, the unit will stop swinging and present position of guide louver will be kept immediately.
- Under left and right swing mode, when the status is switched from off to "  ", if press this button again 2s later, "  " status will switch to off status directly; if press this button again within 2s, the change of swing status will also depend on the

circulation sequence stated above.

- The function is only available for some models.

Clock

Press this button to set clock time. "⌚" icon on remote controller will blink. Press "+" or "-" button within 5s to set clock time. Each pressing of "+" or "-" button, clock time will increase or decrease 1 minute. If hold "+" or "-" button, 2s later, time will change quickly. Release this button when reaching your required time. Press "⏹" button to confirm the time. "⌚" icon stops blinking.



NOTE:

- Clock time adopts 24-hour mode.
- The interval between two operations can't exceed 5s.



Otherwise, remote controller will quit setting status. Operation for TIMER ON/TIMER OFF is the same.

Timer on / Timer off

-  Timer on

"" button can set the time for timer on. After pressing this button, "⌚" icon disappears and the word "ON" on remote controller blinks. Press "+" or "-" button to adjust Timer on setting. After each pressing "+" or "-" button, Timer on setting will increase or decrease 1min. Hold "+" or "-" button, 2s later, the time will change quickly until reaching your required time. Press "" to confirm it. The word "ON" will stop blinking. "⌚" icon resumes displaying. Cancel Timer on: Under the condition that Timer on is started up, press "" button to cancel it.

-  Timer off

"" button can set the time for timer off. After pressing this button, "⌚" icon disappears and the word "OFF" on remote controller blinks. Press "+" or "-" button to adjust Timer off setting. After each pressing "+" or "-" button, Timer off setting will increase or decrease 1min. Hold "+" or "-" button, 2s later, the time will change quickly until reaching your required time. Press "" word "OFF" will stop blinking.

"⌚" icon resumes displaying. Cancel Timer off. Under the condition that Timer off is started up, press "" button to cancel it.

NOTE:

- Under on and off status, you can set Timer off or Timer on simultaneously.
- Before setting Timer on or Timer off, please adjust the clock time.
- After starting up Timer on or Timer off, set the constant circulating valid. After that, air conditioner will be turned on or turned off according to setting time.  button has no effect on setting. If you don't need this function, please use remote controller to cancel it.

Light

Press this button to control the LED status on the display, the circulation change is as follow:

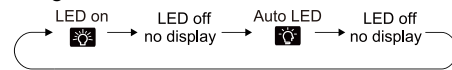

When selecting "" (Auto LED) with remote controller, LED indicator on indoor unit will adjust the luminance automatically according to the ambient intensity of illumination.

NOTE

- Auto LED function may not be available, when air conditioner receives this signal, the air conditioner will run at LED on.



Function introduction for combination buttons

Energy-saving function



Under cooling mode, press "Mode" and "" buttons simultaneously to start up or turn off energy-saving function. When energy-saving function is started up, "SE" will be shown on remote controller, and air conditioner will adjust the set temperature automatically according to ex-factory setting to reach to the best energy-saving effect.

Press "Mode" and "" buttons simultaneously again to exit energy-saving function.

NOTE:

- Under energy-saving function, fan speed is defaulted at auto speed and it can't be adjusted.
- Under energy-saving function, set temperature can't be adjusted.
- Sleep function and energy-saving function can't operate at the same time. If energy-saving function has been set under cool mode, press "" and "" button simultaneously will cancel energy-saving function. If sleep function has been set under cool mode, start up the energy-saving function will cancel sleep function.



Child lock function

Hold "" and "-" buttons simultaneously for 3s to turn on or turn off child lock function. When child lock function is on, "" icon is displayed on remote controller. If you operate the remote controller, the "" icon will blink three times without sending signal to the unit.

Temperature display switchover function

Under OFF status, hold "Mode" and "-" buttons simultaneously for 3s to switch temperature display between °C and °F.

function

Press "MODE" and "" buttons simultaneously to start  function.

 function is for limiting power of the whole unit.

Press this button, the remote controller will circularly display as the following:

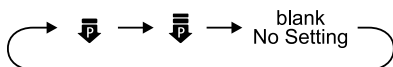

- Maximum power limited under the P mode is lower than that of P mode.
- If you want to cancel the power limiting function, press "Mode" and "Light" buttons simultaneously till the icon in remote controller is not displayed.
- When the remote controller is turned off, power limiting function is cancelled. If you want to activate the function, please repress "Mode" and "Light" buttons simultaneously.
- If the current power is lower than the maximum power of P mode, then the power will not be limited after entering into such mode.
- For the model with one outdoor unit and two indoor units, if any one of indoor units enters into power limiting function, the outdoor unit will enter into the set limiting power mode of indoor unit; when two indoor units enter into power limiting mode, then the power of outdoor unit will be limited according to the lower power of the two indoor units.

NOTE:

This function is only available for some models.

Indoor ambient temperature

By holding "Power" and "Fan" buttons simultaneously, you can see indoor ambient temperature on indoor unit's display. The setting on remote controller is selected circularly as below:

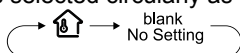

- When selecting "House with thermometer" with remote controller, temperature indicator on indoor unit displays indoor ambient temperature.

NOTE:

- No dual-8 nixie tube for this model; press this button and there is no change for the indicator on the indoor unit.

Clean reminder function of filter

The reminder function is defaulted to be OFF. Hold "Power" and "Fan" buttons simultaneously for 5s to turn it on. The buzzer will give out sound for 0.5s and the dual-8 nixie tube on the display will be on for 3s; Once the reminder function is turned on, when the air conditioner has reached to the set time, the dual-8 nixie tube will flash about 30s when the unit is turned on each time to remind the user to clean the filter; you can turn off this cycle reminder by holding "Power" and "Fan" buttons simultaneously for 5s and then the air conditioner will count time again.

NOTE:

- Once the reminder function is turned on, only this cycle reminder can be cleared.
- This function is only available for some models.
- No dual-8 nixie tube for this model; press this button and there is no change for the indicator on the indoor unit.

Auto clean function

Under unit off status, hold "MODE" and "Light" buttons simultaneously for 5s to turn on or turn off the auto clean function. When the auto clean function is turned on, indoor unit displays "Auto Clean". During the auto clean process of evaporator, the unit will perform fast cooling or fast heating, which is the sound of flowing liquid or thermal expansion or cold shrinkage. The air conditioner may blow cool or warm air, which is a normal phenomenon. During cleaning, please make sure the room is well ventilated to avoid affecting the degree of comfort.

NOTE:

- The auto clean function can only work under normal ambient temperature. If the room is dusty, clean it once a month; if not, clean it once every three months. After the auto clean function is turned on, you can leave the room. When auto clean is finished, the air conditioner will enter standby status.
- This function is only available for some models.

Night mode

Under cooling or heating mode, when turning on sleep mode and turn to low speed or quiet notch, the outdoor unit would enter into night mode.

NOTE:

- When you feel that the cooling and heating effect is poor, please press "Fan" button to other fan speed or press "Power" and "Light" buttons simultaneously to exit the night mode.
- The night mode can only work under normal ambient temperature.
- This function is only available for some models.

I FEEL function

Press "Light" and "+" buttons simultaneously to start I FEEL function and "I FEEL" will be displayed on the remote controller. After this function is set, the remote controller will send the detected ambient temperature to the controller and the unit will automatically adjust the indoor temperature according to the detected temperature. Press "Light" and "+" buttons simultaneously again to turn off I FEEL function and "I FEEL" will disappear.

- Please put the remote controller near user when this function is set. Do not put the remote controller near the object of high temperature or low temperature in order to avoid detecting inaccurate ambient temperature. When I FEEL function is turned on, the remote controller should be put within the area where indoor unit can receive the signal sent by the remote controller.

Sleep function

- Press "Power" and "Light" buttons simultaneously, can select Sleep 1 (U1), Sleep 2 (U2), Sleep 3 (U3) and cancel the Sleep, circulate between these, after electrified, Sleep Cancel is defaulted.
- Sleep 1 is Sleep mode 1, in Cool modes; sleep status after run for one hour, the main unit setting temperature will increase 1 , two hours, setting temperature increased 2 C , then the unit will

run at this setting temperature; In Heat mode: sleep status after run for one hour, the setting temperature will decrease 1 , two hours, setting temperature will decrease 2 , then the unit will run at this setting temperature.

- Sleep 2 is sleep mode 2, that is air conditioner will run according to the presetting a group of sleep temperature curve.
- Sleep 3-the sleep curve setting under Sleep mode by DIY;

(1) Under Sleep 3 mode, press "⏸" button for a long time, remote controller enters into user individuation sleep setting status, at this time, the time of remote controller will display "1HOUR", the setting temperature "88" will display the corresponding temperature of last setting sleep curve and blink (The first entering will display according to the initial curve setting value of original factory);

(2) Adjust "+" and "-" buttons, could change the corresponding setting temperature, after adjusted, press "Turbo" button for confirmation;

(3) At this time, 1hour will be automatically increased at the timer position on the remote control, (that are "2hours" or "3hours" or "8hours"), the place of setting temperature "88" will display the corresponding temperature of last setting sleep curve and blink;

(4) Repeat the above step (2)~(3) operation, until 8 hours temperature setting finished, sleep,curve setting finished, at this time, the remote controller will resume the original timer display; temperature display will resume to original setting temperature.

- Sleep 3 the sleep curve setting under Sleep mode by DIY could be inquired:

The user could accord to sleep curve setting method to inquire the presetting sleep curve, enter into user individuation sleep setting status, but do not change the temperature, press "Turbo" button directly for confirmation. Note: In the above presetting or enquiry procedure, if continuously within 10s, there is no button pressed, the sleep curve setting within 10s, there is no button pressed, the sleep curve setting status will be automatically quit and resume to display the original displaying. In the presetting or enquiry procedure, press "⏸" button, "Mode" button, "⏸" and "⏸" button simultaneously, the sleep curve setting or enquiry status will quit similarly.

Circulation Funtion

When the unit is running under heating mode, holding "Fan" button for 5s to activate circulation function, "FR" icon will be blinked on the remote controller for 3s. When the unit is running under heating mode, holding "Fan" button for 5s to deactivate circulation func-tion, setting tempereature will blinked on the remote controller for 3s.

NOTE:

- Circulation function need to be set again after power failure.
- When matching with the outdoor unit of Free Match, the indoor unit won't execute the circulation function.
- This function is only available for some models.

Replacement of batteries in remote controller

- 1.Press the back side of remote controller marked with "⏸", as shown in the fig, and then push out the cover of battery box along the arrow direction.
- 2.Replace two 7# (AAA 1.5V) dry batteries, and make sure the position of "+" polar and "-" polar are correct.
- 3.Reinstall the cover of battery box.

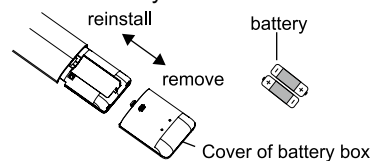

Notice:

- During operation, point the remote control signal sender at the receiving window on indoor unit.
- The distance between signal sender and receiving window should be no more than 8m, and there should be no obstacles between them.
- Signal may be interfered easily in the room where there is fluorescent lamp or wireless telephone; remote controller should be close to indoor unit during operation.
- Replace new batteries of the same model when replacement is required.
- When you don't use remote controller for a long time, please take out the batteries.
- If the display on remote controller is fuzzy or there's no display, please replace batteries.

6.2 GREE+ App Operation Manual

Control Flow Chart

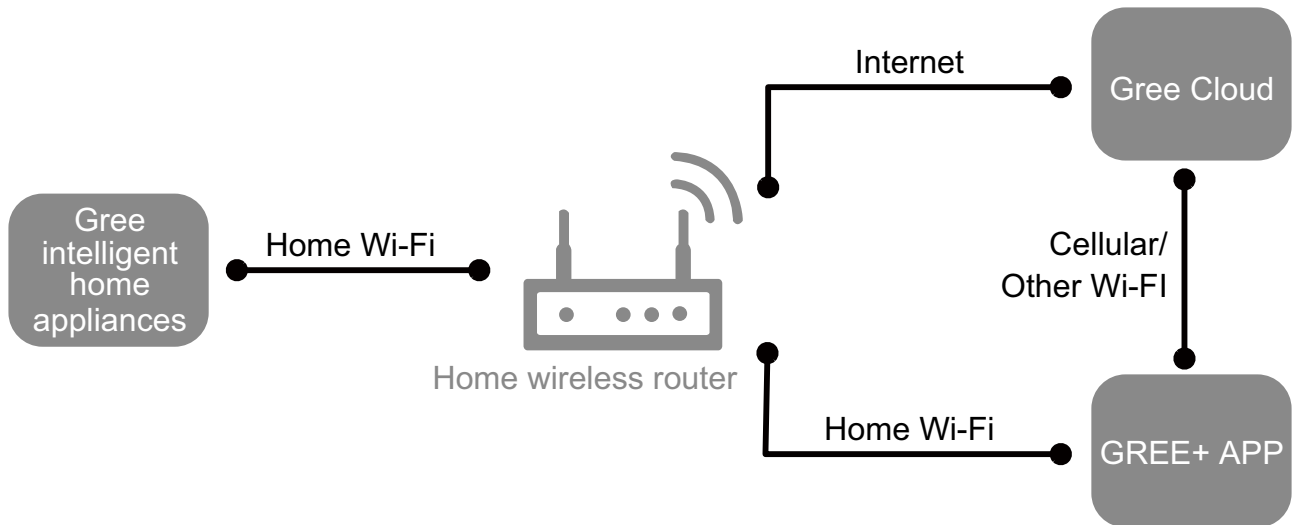

Operating Systems

Requirement for User's smart phone:



iOS system
Support iOS7.0 and
above version



Android system
Support Android 4.4 and
above version

Download and installation



GREE+ App Download Linkage

Scan the QR code or search "GREE+" in the application market to download and install it. When "GREE+" App is installed, register the account and add the device to achieve long-distance control and LAN control of Gree smart home appliances. For more information, please refer to "Help" in App.

6.3 Ewpe Smart App Operation Manual

Control Flow Chart

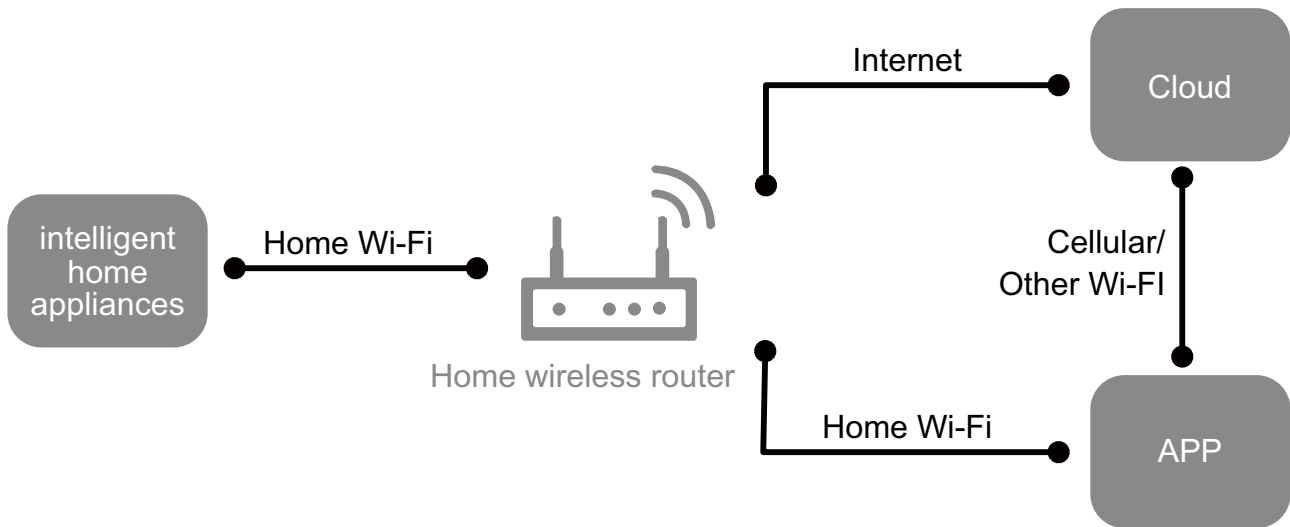

Operating Systems

Requirement for User's smart phone:



iOS system
Support iOS7.0 and
above version



Android system
Support Android 4.4 and
above version

Download and installation



App Download Linkage

Scan the QR code or search "Ewpe Smart" in the application market to download and install it. When "Ewpe Smart" App is installed, register the account and add the device to achieve long-distance control and LAN control of smart home appliances. For more information, please refer to "Help" in App.

6.4 Brief Description of Models and Functions

●Indoor Unit

1.Basic function of system

(1)Cooling mode

(1) Under this mode, fan and swing operates at setting status. Temperature setting range is 16~30°C.

(2) During malfunction of outdoor unit or the unit is stopped because of protection, indoor unit keeps original operation status.

(2)Drying mode

(1) Under this mode, fan operates at low speed and swing operates at setting status. Temperature setting range is 16~30°C.

(2) During malfunction of outdoor unit or the unit is stopped because of protection, indoor unit keeps original operation status.

(3) Protection status is same as that under cooling mode.

(4) Sleep function is not available for drying mode.

(3)Heating mode

(1) Under this mode, Temperature setting range is 16~30°C.

(2) Working condition and process for heating mode:

When turn on the unit under heating mode, indoor unit enters into cold air prevention status. When the unit is stopped or at OFF status, and indoor unit has been started up just now, the unit enters into residual heat-blowing status.

(4)Working method for AUTO mode:

1.Working condition and process for AUTO mode:

a.Under AUTO mode, standard heating $T_{\text{preset}}=20^{\circ}\text{C}$ and standard cooling $T_{\text{preset}}=25^{\circ}\text{C}$. The unit will switch mode automatically according to ambient temperature.

2.Protection function

a. During cooling operation, protection function is same as that under cooling mode.

b. During heating operation, protection function is same as that under heating mode.

3. Display: Set temperature is the set value under each condition. Ambient temperature is ($T_{\text{amb.}}-T_{\text{compensation}}$) for heat pump unit and $T_{\text{amb.}}$ for cooling only unit.

4. If there's I feel function, $T_{\text{compensation}}$ is 0. Others are same as above.

(5)Fan mode

Under this mode, indoor fan operates at set fan speed. Compressor, outdoor fan, 4-way valve and electric heating tube stop operation. Indoor fan can select to operate at high, medium, low or auto fan speed. Temperature setting range is 16~30°C.

2. Other control

(1) Buzzer

Upon energization or availably operating the unit or remote controller, the buzzer will give out a beep.

(2) Auto button

If press this auto button when turning off the unit, the complete unit will operate at auto mode. Indoor fan operates at auto fan speed and swing function is turned on. Press this auto button at ON status to turn off the unit.

(3) Auto fan

Heating mode: During auto heating mode or normal heating mode, auto fan speed will adjust the fan speed automatically according to ambient temperature and set temperature.

(4) Sleep

After setting sleep function for a period of time, system will adjust set temperature automatically.

(5) Timer function:

General timer and clock timer functions are compatible by equipping remote controller with different functions.

(6) Entry condition for compulsory defrosting function

When turn on the unit under heating mode and set temperature is 16°C (or 16.5°C by remote controller), press "+, -, +, -, +, -" button successively within 5s and then indoor unit will enter into compulsory defrosting setting status:

(1) If there's only indoor units controller, it enters into indoor normal defrosting mode.

(2) If there's indoor units controller and outdoor units controller, indoor unit will send compulsory defrosting mode signal to outdoor unit and then outdoor unit will operate under normal defrosting mode. After indoor unit received the signal that outdoor unit has entered into defrosting status, indoor unit will cancel to send compulsory mode to outdoor unit. If outdoor unit hasn't received feedback signal from outdoor unit after 3min, indoor unit will also cancel to send compulsory defrosting signal.

(7)Refrigerant recovery function:

Enter into Freon recovery mode actively: Within 5min after energization, turn on the unit at 16°C under cooling mode, and press light button for 3 times within 3s to enter into Freon recovery mode. Fo is displayed and Freon recovery mode will be sent to outdoor unit.

(8)Ambient temperature display control mode

When the remote controller is turned on, press "⏻" and "🔊" buttons simultaneously on the remote controller and the indoor unit will display the temperature of remote controller sensor for 10s.

(9)Off-peak energization function:

Adjust compressors minimum stop time. The original minimum stop time is 180s and then we change to:

The time interval between two start-ups of compressor can't be less than $(180+T)\text{s}$ ($0\leq T\leq 15$). T is the variable of controller. That's to say the minimum stop time of compressor is 180s~195s. Read-in T into memory chip when refurbish the memory chip each time. After power recovery, compressor can only be started up after $(180+T)\text{s}$ at least.

(10) Turbo function

Turbo function can be set under cooling and heating modes. Press Fan Speed button to cancel turbo setting. Turbo function is not available under auto, drying and fan modes.

(11) Auto clean function of indoor heat exchanger

Through the phases of condensation, frosting, defrosting and high temperature of evaporator, dedusting and sterilization can be achieved.

1. Under power-off status, press and hold "Interior Clean" button for 3 seconds, the auto clean function can be turned on. After the function is turned on, the air conditioner displays "CL".

2. The cleaning function cannot be turned off via remote controller, it can only automatically quit after finishing the cleaning or be compulsorily turned off by cutting off the power.

3. The evaporator will fast conduct cooling or heating during the auto cleaning course, and there may be noise or even large noise, which is a normal phenomenon due to the plastic components' expansion caused by heat and contraction caused by cold. During the course of cleaning and sterilization, the room temperature may slightly increase, please keep the room be well ventilated.

Warm prompt:

If the indoor environment is easily be dusty, it is supposed to clean once a month. If the indoor environment is not so easily be dusty, it is supposed to clean once in three months. After turning on the auto clean mode, user can leave the room. After finishing the cleaning, the unit will automatically enter into stand-by mode.

● Outdoor Unit

1. Cooling mode:

Working condition and process of cooling mode:

① When $T_{\text{indoor ambient temperature}} \geq T_{\text{preset}}$, unit enters into cooling mode. Indoor fan, outdoor fan and compressor start operation. Indoor fan operates according to set fan speed.

② When $T_{\text{indoor ambient temperature}} \leq T_{\text{preset}} - 2^{\circ}\text{C}$, compressor stops operation and outdoor fan will stop 30s later. Indoor fan operates according to set fan speed.

③ When $T_{\text{preset}} - 2^{\circ}\text{C} < T_{\text{indoor ambient temperature}} < T_{\text{preset}}$, unit operates according to the previous status.

Under cooling mode, 4-way valve is not energized. Temperature setting range is 16~30°C. If compressor stops because of malfunction in cooling mode, indoor fan and swing motor will work according to the original status.

2. Drying mode

(1) Working condition and process of drying mode

① When $T_{\text{indoor ambient temperature}} > T_{\text{preset}}$, unit will be in drying mode. Outdoor fan and compressor start operation while indoor fan will operate at low fan speed.

② When $T_{\text{preset}} - 2^{\circ}\text{C} \leq T_{\text{indoor ambient temperature}} \leq T_{\text{preset}}$, unit operates according to the previous status.

③ When $T_{\text{indoor ambient temperature}} < T_{\text{preset}} - 2^{\circ}\text{C}$, compressor stops operation and outdoor fan will stop 30s later.

(2) Under drying mode, 4-way valve is not energized. Temperature setting range is 16~30°C.

(3) Protection function: same as in cooling mode.

3. Fan mode

(1) Under this mode, indoor fan can select different fan speed

(except Turbo) or auto fan speed. Compressor, outdoor fan and 4-way valve all stop operation.

(2) In fan mode, temperature setting range is 16~30°C.

4. Heating mode

Working condition and process of heating mode:

① When $T_{\text{preset}} - (T_{\text{indoor ambient temperature}} - T_{\text{compensation}}) \geq 1^{\circ}\text{C}$, unit enters into heating mode. Compressor, outdoor fan and 4-way valve start operation.

② When $-2^{\circ}\text{C} < T_{\text{preset}} - (T_{\text{indoor ambient temperature}} - T_{\text{compensation}}) < 1^{\circ}\text{C}$, unit operates according to the previous status.

③ When $T_{\text{preset}} - (T_{\text{indoor ambient temperature}} - T_{\text{compensation}}) \leq -2^{\circ}\text{C}$, compressor stops operation and outdoor fan will stop 30s later. Indoor fan will be in residual-heat blowing status.

④ When unit is turned off under heating mode or changed to other modes from heating mode, 4-way valve will be power-off 2min after compressor stops working (compressor is in operation status under heating mode).

⑤ When $T_{\text{outdoor ambient temperature}} > 30^{\circ}\text{C}$, compressor stops operation immediately. Outdoor fan will stop 30s later.

⑥ Under the condition that compressor is turned on, when unit is changed to heating mode from cooling or drying mode, 4-way valve will be energized in 2~3mins delay.

Note: $T_{\text{compensation}}$ is determined by IDU and ODU. If IDU controls the compensation temperature, then $T_{\text{compensation}}$ is determined according to the value sent by IDU to ODU; If IDU does not control the compensation temperature, then $T_{\text{compensation}}$ will default to 3°C by the ODU.

5. Freon recovery mode

After the Freon recovery signal from IDU is received, cooling at rated frequency will be forcibly turned on to recover Freon.

Indoor unit will display Fo. If any signal from remote controller is received, unit will exit from Freon recovery mode and indoor unit stops displaying Fo.

6. Compulsory defrosting

If unit is turned on under heating mode and set temperature is 16°C (by remote controller), press "+, -, +, -, +, -" within 5s, unit will enter into compulsory defrosting mode and send the signal to ODU. When the compulsory defrosting signal from ODU is received, IDU will exit from the compulsory defrosting mode and stop sending the signal to ODU.

After ODU receives the compulsory defrosting code, it will start compulsory defrosting. Defrosting frequency and opening angle will be the same as in normal defrosting mode. When compulsory defrosting is finished, the complete unit resumes original status.

7. Auto mode

Auto mode is determined by controller of IDU. See IDU logic for details.

8. 8°C heating

Set temperature is 8°C. Display board of IDU displays 8°C. Under this mode, “Cold air prevention” function is shielded.

If compressor is operating under this mode, fan speed will adjust according to auto fan speed; if compressor stops operation under this mode, indoor fan will be in residual-heat blowing status.

9.Auto Clean Mode

After receiving the command of auto clean mode sent by IDU, ODU controls the compressor, outdoor fan, electronic expansion valve and 4-way valve to operate according to the fixed order, which helps the evaporator of IDU to go through three phases of condensation, frosting, and defrosting, and finally achieve the purpose of auto clean. Under such mode, if any protection occurs in the ODU and leads to shutdown of unit, please quit the auto clean mode immediately.

When power on, communication light will be blinking in a normal way (after receiving a group of correct signals, blinking stops for 0.2s~0.3s). If there's no communication, communication light will be always on. If other ODU has malfunction, communication light will be on for 1s and off for 1s in a circular way.

7. Notes for Installation and Maintenance

Safety Precautions: Important!

Please read the safety precautions carefully before installation and maintenance.

The following contents are very important for installation and maintenance.

Please follow the instructions below.

- The installation or maintenance must accord with the instructions.
- Comply with all national electrical codes and local electrical codes.
- Pay attention to the warnings and cautions in this manual.
- All installation and maintenance shall be performed by distributor or qualified person.
- All electric work must be performed by a licensed technician according to local regulations and the instructions given in this manual.
- Be caution during installation and maintenance. Prohibit incorrect operation to prevent electric shock, casualty and other accidents.



WARNINGS

Electrical Safety Precautions:

1. Cut off the power supply of air conditioner before checking and maintenance.
2. The air condition must apply specialized circuit and prohibit share the same circuit with other appliances.
3. The air conditioner should be installed in suitable location and ensure the power plug is touchable.
4. Make sure each wiring terminal is connected firmly during installation and maintenance.
5. Have the unit adequately grounded. The grounding wire can't be used for other purposes.
6. Must apply protective accessories such as protective boards, cable-cross loop and wire clip.
7. The live wire, neutral wire and grounding wire of power supply must be corresponding to the live wire, neutral wire and grounding wire of the air conditioner.
8. The power cord and power connection wires can't be pressed by hard objects.
9. If power cord or connection wire is broken, it must be replaced by a qualified person.
10. If the power cord or connection wire is not long enough, please get the specialized power cord or connection wire from the manufacture or distributor. Prohibit prolong the wire by yourself.

11. For the air conditioner without plug, an air switch must be installed in the circuit. The air switch should be all-pole parting and the contact parting distance should be more than 3mm.

12. Make sure all wires and pipes are connected properly and the valves are opened before energizing.

13. Check if there is electric leakage on the unit body. If yes, please eliminate the electric leakage.

14. Replace the fuse with a new one of the same specification if it is burnt down; don't replace it with a cooper wire or conducting wire.

15. If the unit is to be installed in a humid place, the circuit breaker must be installed.

Installation Safety Precautions:

1. Select the installation location according to the requirement of this manual.(See the requirements in installation part)
2. Handle unit transportation with care; the unit should not be carried by only one person if it is more than 20kg.
3. When installing the indoor unit and outdoor unit, a sufficient fixing bolt must be installed; make sure the installation support is firm.
4. Ware safety belt if the height of working is above 2m.
5. Use equipped components or appointed components during installation.
6. Make sure no foreign objects are left in the unit after finishing installation.

Refrigerant Safety Precautions:

1. When refrigerant leaks or requires discharge during installation, maintenance, or disassembly, it should be handled by certified professionals or otherwise in compliance with local laws and regulations.
- 2.Avoid contact between refrigerant and fire as it generates poisonous gas; Prohibit prolong the connection pipe by welding.
3. Apply specified refrigerant only. Never have it mixed with any other refrigerant. Never have air remain in the refrigerant line as it may lead to rupture or other hazards.
4. Make sure no refrigerant gas is leaking out when installation is completed.
5. If there is refrigerant leakage, please take sufficient measure to minimize the density of refrigerant.
6. Never touch the refrigerant piping or compressor without wearing glove to avoid scald or frostbite.

Improper installation may lead to fire hazard, explosion, electric shock or injury.

Safety Precautions for Installing and Relocating the Unit:

To ensure safety, please be mindful of the following precautions.

WARNINGS

1. When installing or relocating the unit, be sure to keep the refrigerant circuit free from air or substances other than the specified refrigerant.

Any presence of air or other foreign substance in the refrigerant circuit will cause system pressure rise or compressor rupture, resulting in injury.

2. When installing or moving this unit, do not charge the refrigerant which is not comply with that on the nameplate or unqualified refrigerant.

Otherwise, it may cause abnormal operation, wrong action, mechanical malfunction or even series safety accident.

3. When refrigerant needs to be recovered during relocating or repairing the unit, be sure that the unit is running in cooling mode. Then, fully close the valve at high pressure side (liquid valve). About 30-40 seconds later, fully close the valve at low pressure side (gas valve), immediately stop the unit and disconnect power. Please note that the time for refrigerant recovery should not exceed 1 minute.

If refrigerant recovery takes too much time, air may be sucked in and cause pressure rise or compressor rupture, resulting in injury.

4. During refrigerant recovery, make sure that liquid valve and gas valve are fully closed and power is disconnected before detaching the connection pipe.

If compressor starts running when stop valve is open and connection pipe is not yet connected, air will be sucked in and cause pressure rise or compressor rupture, resulting in injury.

5. When installing the unit, make sure that connection pipe is securely connected before the compressor starts running.

If compressor starts running when stop valve is open and connection pipe is not yet connected, air will be sucked in and cause pressure rise or compressor rupture, resulting in injury.

6. Prohibit installing the unit at the place where there may be leaked corrosive gas or flammable gas.

If there leaked gas around the unit, it may cause explosion and other accidents.

7. Do not use extension cords for electrical connections. If the electric wire is not long enough, please contact a local service center authorized and ask for a proper electric wire.

Poor connections may lead to electric shock or fire.

8. Use the specified types of wires for electrical connections between the indoor and outdoor units. Firmly clamp the wires so that their terminals receive no external stresses.

Electric wires with insufficient capacity, wrong wire connections and insecure wire terminals may cause electric shock or fire.

Safety Precautions for Refrigerant

- To realize the function of the air conditioner unit, a special refrigerant circulates in the system. The used refrigerant is the fluoride R32, which is specially cleaned. The refrigerant is flammable and odorless. Furthermore, it can lead to explosion under certain conditions. But the flammability of the refrigerant is very low. It can be ignited only by fire.
- Compared to common refrigerants, R32 is a nonpolluting refrigerant with no harm to the ozone layer. The influence upon the greenhouse effect is also lower. R32 has got very good thermodynamic features which lead to a really high energy efficiency. The units therefore need a less filling.

WARNING:

- Do not use means to accelerate the defrosting process or to clean, other than those recommended by the manufacturer. Should repair be necessary, contact your nearest authorized Service Centre. Any repairs carried out by unqualified personnel may be dangerous. The appliance shall be stored in a room without continuously operating ignition sources. (for example: open flames, an operating gas appliance or an operating electric heater.)
- Do not pierce or burn.
- Appliance shall be installed, operated and stored in a room with a floor area larger than Xm^2 .
- Appliance filled with flammable gas R32. For repairs, strictly follow manufacturer's instructions only. Be aware that refrigerants do not contain odor.
- Read specialist manual.

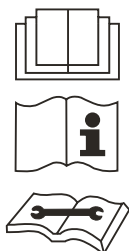

Safety Operation of Flammable Refrigerant

Qualification requirement for installation and maintenance man

- Any person who is involved with working on or breaking into a refrigerant circuit should hold a current valid certificate from an industry-accredited assessment authority, which authorizes their competence to handle refrigerants safely in accordance with an industry recognized assessment specification.
- Servicing shall only be performed as recommended by the equipment manufacturer. Maintenance and repair requiring the assistance of other skilled personnel shall be carried out under the supervision of the person competent in the use of flammable refrigerants.

Installation notes

- The air conditioner is not allowed to use in a room that

has running fire (such as fire source, working coal gas ware, operating heater).

- It is not allowed to drill hole or burn the connection pipe.
- The air conditioner must be installed in a room that is larger than the minimum room area. The minimum room area is shown on the nameplate or following table a.
- Leak test is a must after installation.

table a - Minimum room area (m^2)

Charge amount (kg)	floor location	window mounted	wall mounted	ceiling mounted
≤1.2	4	4	4	4
1.3	14.5	5.2	4	4
1.4	16.8	6.1	4	4
1.5	19.3	7	4	4
1.6	22	7.9	4	4
1.7	24.8	8.9	4	4
1.8	27.8	10	4	4
1.9	31	11.2	4	4
2	34.3	12.4	4	4
2.1	37.8	13.6	4.2	4
2.2	41.5	15	4.6	4
2.3	45.4	16.3	5	4
2.4	49.4	17.8	5.5	4
2.5	53.6	19.3	6	4

Maintenance notes

- Check whether the maintenance area or the room area meet the requirement of the nameplate.
 - Its only allowed to be operated in the rooms that meet the requirement of the nameplate.
- Check whether the maintenance area is well-ventilated.
 - The continuous ventilation status should be kept during the operation process.
- Check whether there is fire source or potential fire source in the maintenance area.
 - The naked flame is prohibited in the maintenance area; and the “no smoking” warning board should be hanged.
- Check whether the appliance mark is in good condition.
 - Replace the vague or damaged warning mark.

Welding

- If you should cut or weld the refrigerant system pipes in the process of maintaining, please follow the steps as below:
 - a. Shut down the unit and cut power supply
 - b. Eliminate the refrigerant
 - c. Vacuuming
 - d. Clean it with N_2 gas
 - e. Cutting or welding
 - f. Carry back to the service spot for welding
- Make sure that there isn't any naked flame near the outlet of the vacuum pump and its well-ventilated.
- The refrigerant should be recycled into the specialized storage tank.

Filling the refrigerant

- Use the refrigerant filling appliances specialized for R32.

Make sure that different kinds of refrigerant won't contaminate with each other.

- The refrigerant tank should be kept upright at the time of filling refrigerant.
- Stick the label on the system after filling is finished (or haven't finished).
- Dont overfilling.
- After filling is finished, please do the leakage detection before test running; another time of leak detection should be done when its removed.

Safety instructions for transportation and storage

- Please use the flammable gas detector to check before unload and open the container.
- No fire source and smoking.
- According to the local rules and laws.

Prior to beginning work on systems containing flammable refrigerants, safety checks are necessary to ensure that the risk of ignition is minimised. For repair to the refrigerating system, the following precautions shall be complied with prior to conducting work on the system.

●Work procedure

Work shall be undertaken under a controlled procedure so as to minimise the risk of a flammable gas or vapour being present while the work is being performed.

●General work area

All maintenance staff and others working in the local area shall be instructed on the nature of work being carried out. Work in confined spaces shall be avoided. The area around the workspace shall be sectioned off. Ensure that the conditions within the area have been made safe by control of flammable material

●Checking for presence of refrigerant

The area shall be checked with an appropriate refrigerant detector prior to and during work, to ensure the technician is aware of potentially toxic or flammable atmospheres.

Ensure that the leak detection equipment being used is suitable for use with all applicable refrigerants, i.e. non-sparking, adequately sealed or intrinsically safe.

●Presence of fire extinguisher

If any hot work is to be conducted on the refrigeration equipment or any associated parts, appropriate fire extinguishing equipment shall be available to hand. Have a dry powder or CO₂ fire extinguisher adjacent to the charging area.

●No ignition sources

No person carrying out work in relation to a refrigeration system which involves exposing any pipe work shall use any sources of ignition in such a manner that it may lead to the risk of fire or explosion. All possible ignition sources, including cigarette smoking, should be kept sufficiently far away from the site of installation, repairing, removing and disposal, during which refrigerant can possibly be released to the surrounding space. Prior to work taking place, the area around the equipment is to be

surveyed to make sure that there are no flammable hazards or ignition risks. " NO Smoking " signs shall be displayed.

●Ventilated area

Ensure that the area is in the open or that it is adequately ventilated before breaking into the system or conducting any hot work. A degree of ventilation shall continue during the period that the work is carried out. The ventilation should safely disperse any released refrigerant and preferably expel it externally into the atmosphere.

●Checks to the refrigeration equipment

Where electrical components are being changed, they shall be fit for the purpose and to the correct specification. At all times the manufacturer's maintenance and service guidelines shall be followed. If in doubt, consult the manufacturer's technical department for assistance.

The following checks shall be applied to installations using flammable refrigerants:

- The actual refrigerant charge is in accordance with the room size within which the refrigerant containing parts are installed;
- The ventilation machinery and outlets are operating adequately and are not obstructed;
- If an indirect refrigerating circuit is being used, the secondary circuit shall be checked for the presence of refrigerant;
- Marking to the equipment continues to be visible and legible. Markings and signs that are illegible shall be corrected;
- Refrigeration pipe or components are installed in a position where they are unlikely to be exposed to any substance which may corrode refrigerant containing components, unless the components are constructed of materials which are inherently resistant to being corroded or are suitably protected against being so corroded.

●Checks to electrical devices

Repair and maintenance to electrical components shall include initial safety checks and component inspection procedures. If a fault exists that could compromise safety, then no electrical supply shall be connected to the circuit until it is satisfactorily dealt with. If the fault cannot be corrected immediately but it is necessary to continue operation, an adequate temporary solution shall be used. This shall be reported to the owner of the equipment so all parties are advised.

Initial safety checks shall include:

- 1.That capacitors are discharged: this shall be done in a safe manner to avoid possibility of sparking;
- 2.That no live electrical components and wiring are exposed while charging, recovering or purging the system;
- 3.That there is continuity of earth bonding.

●Repairs to sealed components

1. During repairs to sealed components, all electrical supplies shall be disconnected from the equipment being worked upon prior to any removal of sealed covers, etc. If it is absolutely necessary

to have an electrical supply to equipment during servicing, then a permanently operating form of leak detection shall be located at the most critical point to warn of a potentially hazardous situation.

2. Particular attention shall be paid to the following to ensure that by working on electrical components, the casing is not altered in such a way that the level of protection is affected. This shall include damage to cables, excessive number of connections, terminals not made to original specification, damage to seals, incorrect fitting of glands, etc.

Ensure that the apparatus is mounted securely.

Ensure that seals or sealing materials have not degraded to the point that they no longer serve the purpose of preventing the ingress of flammable atmospheres.

Replacement parts shall be in accordance with the manufacturer's specifications.

NOTE : The use of silicon sealant can inhibit the effectiveness of some types of leak detection equipment. Intrinsically safe components do not have to be isolated prior to working on them.

●Repair to intrinsically safe components

Do not apply any permanent inductive or capacitance loads to the circuit without ensuring that this will not exceed the permissible voltage and current permitted for the equipment in use.

Intrinsically safe components are the only types that can be worked on while live in the presence of a flammable atmosphere. The test apparatus shall be at the correct rating.

Replace components only with parts specified by the manufacturer. Other parts may result in the ignition of refrigerant in the atmosphere from a leak.

●Cabling

Check that cabling will not be subject to wear, corrosion, excessive pressure, vibration, sharp edges or any other adverse environmental effects. The check shall also take into account the effects of aging or continual vibration from sources such as compressors or fans.

●Detection of flammable refrigerants

Under no circumstances shall potential sources of ignition be used in the searching for or detection of refrigerant leaks. A halide torch (or any other detector using a naked flame) shall not be used.

●Leak detection methods

The following leak detection methods are deemed acceptable for all refrigerant systems.

Electronic leak detectors may be used to detect refrigerant leaks but, in the case of flammable refrigerants, the sensitivity may not be adequate, or may need re-calibration.

(Detection equipment shall be calibrated in a refrigerant-free area.)

Ensure that the detector is not a potential source of ignition and is suitable for the refrigerant used.

Leak detection equipment shall be set at a percentage of the LFL of the refrigerant and shall be calibrated to the refrigerant employed, and the appropriate percentage of gas (25 % maximum) is confirmed.

Leak detection fluids are suitable for use with most refrigerants but the use of detergents containing chlorine shall be avoided as the chlorine may react with the refrigerant and corrode the copper pipe-work.

If a leak is suspected, all naked flames shall be removed/ extinguished.

If a leakage of refrigerant is found which requires brazing, all of the refrigerant shall be recovered from the system, or isolated (by means of shut off valves) in a part of the system remote from the leak. For appliances containing flammable refrigerants, oxygen free nitrogen (OFN) shall then be purged through the system both before and during the brazing process.

●Removal and evacuation

When breaking into the refrigerant circuit to make repairs – or for any other purpose –conventional procedures shall be used. However, for flammable refrigerants it is important that best practice is followed since flammability is a consideration. The following procedure shall be adhered to:

- 1.remove refrigerant;
- 2.purge the circuit with inert gas; evacuate;
- 3.purge again with inert gas;
- 4.open the circuit by cutting or brazing.

The refrigerant charge shall be recovered into the correct recovery cylinders.

For appliances containing flammable refrigerants, the system shall be “flushed” with OFN to render the unit safe. This process may need to be repeated several times. Compressed air or oxygen

Main Tools for Installation and Maintenance



Level meter



Measuring tape



Screw driver



Impact drill



Drill head



Electric drill



Electroprobe



Universal meter



Torque wrench



Open-end wrench



Inner hexagon spanner



Electronic leakage detector



Vacuum pump



Pressure meter



Pipe pliers



Pipe pliers



Pipe cutter



Pipe expander



Pipe bender



Soldering appliance



Refrigerant container



Electronic scale

8. Installation

8.1 Installation Dimension Diagram

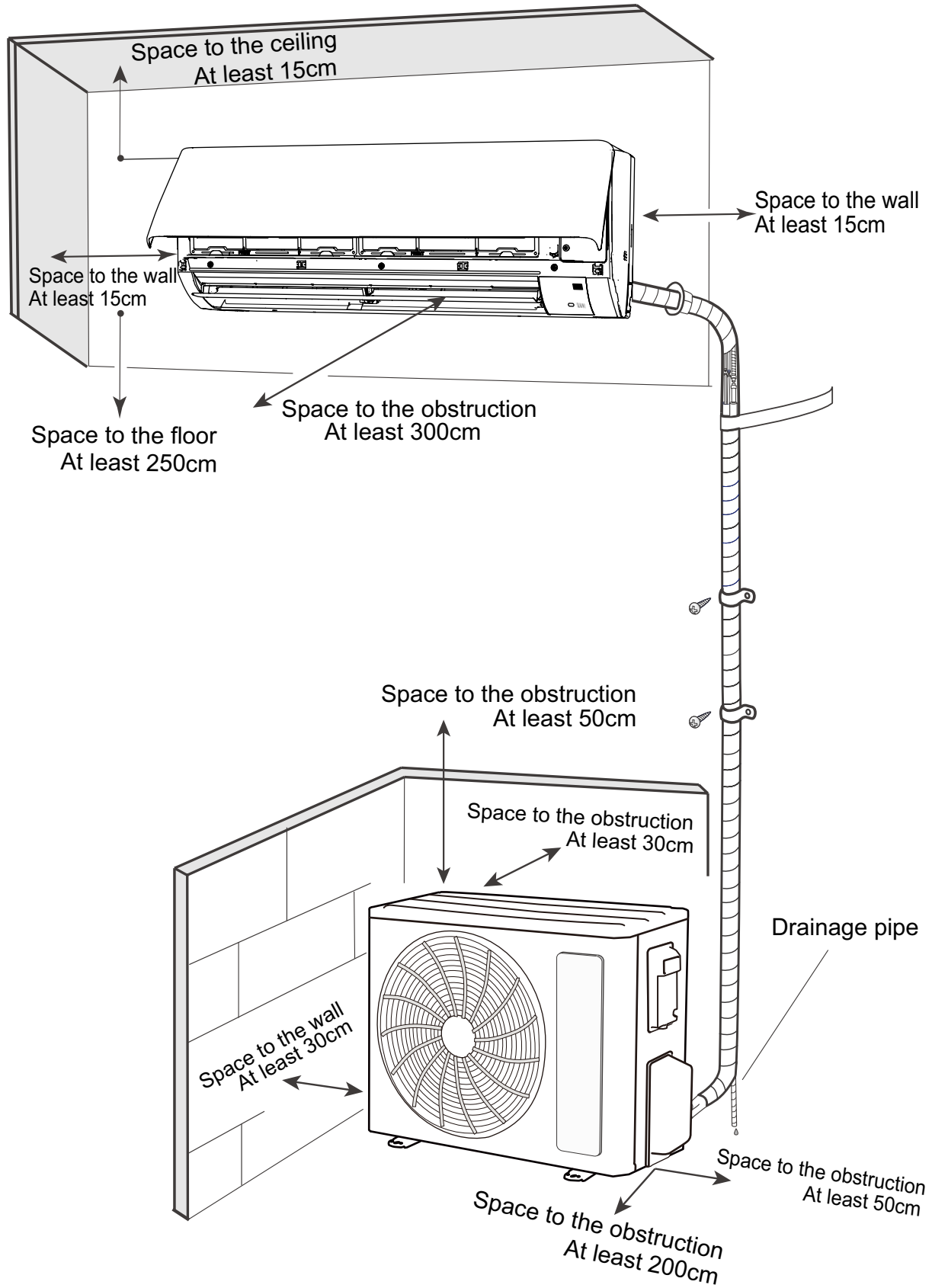

Installation Procedures

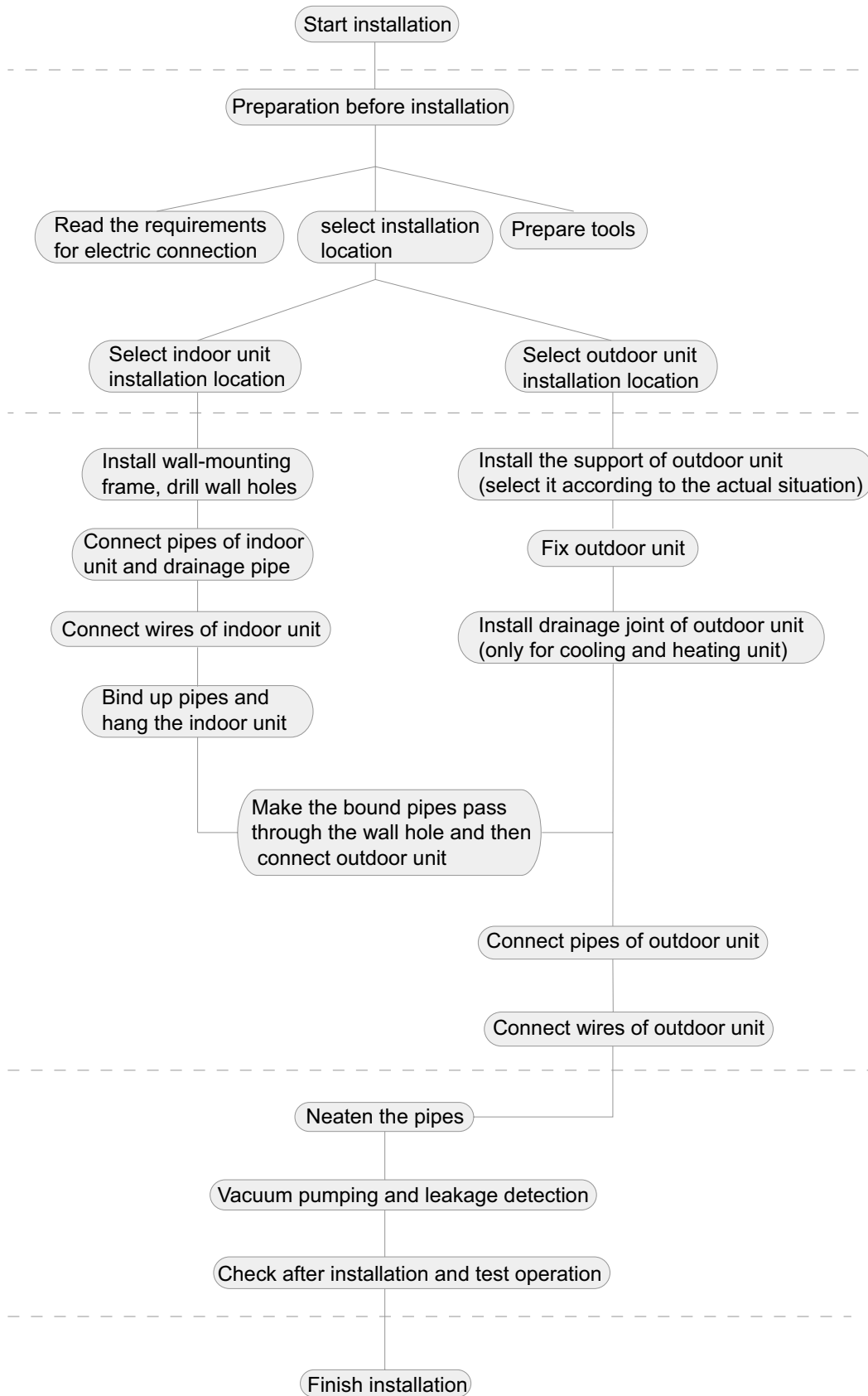

Note: this flow is only for reference; please find the more detailed installation steps in this se

8.2 Installation Parts-checking

No.	Name
1	Indoor unit
2	Outdoor unit
3	Connection pipe
4	Drainage pipe
5	Wall-mounting frame
6	Connecting cable(power cord)
7	Wall pipe
8	Sealing gum
9	Wrapping tape
10	Support of outdoor unit
11	Fixing screw
12	Drainage plug(cooling and heating unit)
13	Owners manual, remote controller

⚠ Note:

1. Please contact the local agent for installation.
2. Don't use unqualified power cord.

8.3 Selection of Installation Location

1. Basic Requirement:

Installing the unit in the following places may cause malfunction. If it is unavoidable, please consult the local dealer:

- (1) The place with strong heat sources, vapors, flammable or explosive gas, or volatile objects spread in the air.
- (2) The place with high-frequency devices (such as welding machine, medical equipment).
- (3) The place near coast area.
- (4) The place with oil or fumes in the air.
- (5) The place with sulfured gas.
- (6) Other places with special circumstances.
- (7) The appliance shall not be installed in the laundry.
- (8) It's not allowed to be installed on the unstable or motive base structure (such as truck) or in the corrosive environment (such as chemical factory).

2. Indoor Unit:

- (1) There should be no obstruction near air inlet and air outlet.
- (2) Select a location where the condensation water can be dispersed easily and won't affect other people.
- (3) Select a location which is convenient to connect the outdoor unit and near the power socket.
- (4) Select a location which is out of reach for children.
- (5) The location should be able to withstand the weight of indoor unit and won't increase noise and vibration.
- (6) The appliance must be installed 2.5m above floor.
- (7) don't install the indoor unit right above the electric appliance.
- (8) Please try your best to keep way from fluorescent lamp.

3. Outdoor Unit:

- (1) Select a location where the noise and outflow air emitted by the outdoor unit will not affect neighborhood.
- (2) The location should be well ventilated and dry, in which the outdoor unit won't be exposed directly to sunlight or strong wind.

- (3) The location should be able to withstand the weight of outdoor unit.
- (4) Make sure that the installation follows the requirement of installation dimension diagram.
- (5) Select a location which is out of reach for children and far away from animals or plants. If it is unavoidable, please add fence for safety purpose.

8.4 Electric Connection Requirement

1. Safety Precaution

- (1) Must follow the electric safety regulations when installing the unit.
- (2) According to the local safety regulations, use qualified power supply circuit and air switch.
- (3) Make sure the power supply matches with the requirement of air conditioner. Unstable power supply or incorrect wiring may result in electric shock, fire hazard or malfunction. Please install proper power supply cables before using the air conditioner.
- (4) Properly connect the live wire, neutral wire and grounding wire of power socket.
- (5) Be sure to cut off the power supply before proceeding any work related to electricity and safety.
- (6) Do not put through the power before finishing installation.
- (7) If the supply cord is damaged, it must be replaced by the manufacturer, its service agent or similarly qualified persons in order to avoid a hazard.
- (8) The temperature of refrigerant circuit will be high, please keep the interconnection cable away from the copper tube.
- (9) The appliance shall be installed in accordance with national wiring regulations.
- (10) Appliance shall be installed, operated and stored in a room with a floor area larger than Xm^2 (Please refer to table "a" in section of " Safety Operation of Inflammable Refrigerant" for Space X.)



Please notice that the unit is filled with flammable gas R32. Inappropriate treatment of the unit involves the risk of severe damages of people and material. Details to this refrigerant are found in chapter "refrigerant".

2. Grounding Requirement:

- (1) The air conditioner is the first class electric appliance. It must be properly grounded with specialized grounding device by a professional. Please make sure it is always grounded effectively, otherwise it may cause electric shock.
- (2) The yellow-green wire in air conditioner is grounding wire, which can't be used for other purposes.
- (3) The grounding resistance should comply with national electric safety regulations.
- (4) The appliance must be positioned so that the plug is accessible.
- (5) An all-pole disconnection switch having a contact separation of at least 3mm in all poles should be connected in fixed wiring.
- (6) Including an air switch with suitable capacity, please note the following table. Air switch should be included magnet buckle and heating buckle function, it can protect the circuit-short and overload. (Caution: please do not use the fuse only for protect the circuit)

Model	Air switch capacity	Power cord
9/12K	10A	3x1.0mm ²
18K	16A	3x1.5mm ²

8.5 Installation of Indoor Unit

1. Choosing Installation location

Recommend the installation location to the client and then confirm it with the client.

2. install wall-mounting frame

(1) Hang the wall-mounting frame on the wall; adjust it in horizontal position with the level meter and then point out the screw fixing holes on the wall.

(2) Drill the screw fixing holes on the wall with impact drill (the specification of drill head should be the same as the plastic expansion particle) and then fill the plastic expansion particles in the holes.

(3) Fix the wall-mounting frame on the wall with tapping screws and then check if the frame is firmly installed by pulling the frame. If the plastic expansion particle is loose, please drill another fixing hole nearby.

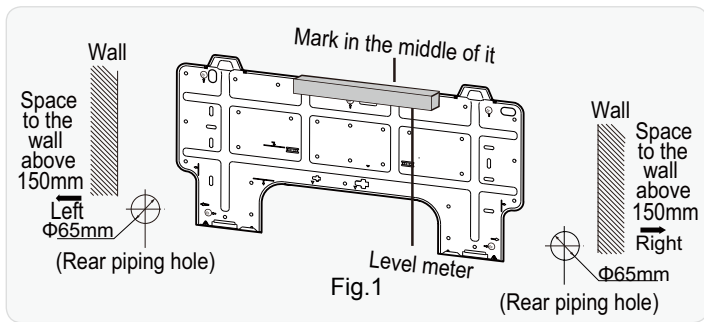

3. Open piping hole

(1) Choose the position of piping hole according to the direction of outlet pipe. The position of piping hole should be a little lower than the wall-mounted frame, shown as below. (As show in Fig.1)

(2) Open a piping hole with the diameter of $\Phi 55\text{mm}$ or $\Phi 70\text{mm}$ on the selected outlet pipe position. In order to drain smoothly, slant the piping hole on the wall slightly downward to the outdoor side with the gradient of $5\text{-}10^\circ$. (As show in Fig.2)

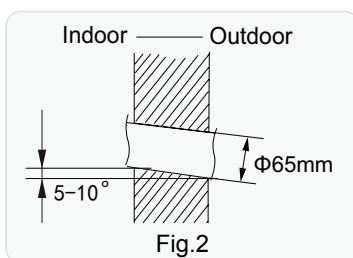

Note:

Pay attention to dust prevention and take relevant safety measures when opening the hole.

4. Outlet Pipe

(1) The pipe can be led out in the direction of right, rear right, left or rear left. (As show in Fig.3)

(2) When selecting leading out the pipe from left or right, please cut off the corresponding hole on the bottom case. (As show in Fig.4)

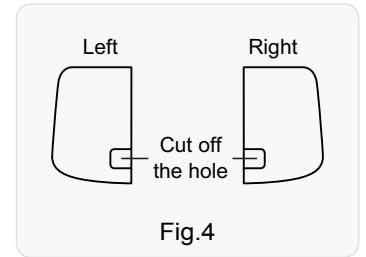
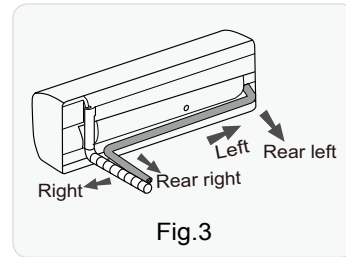

5. Connect the Pipe of Indoor Unit

(1) Aim the pipe joint at the corresponding bellmouth. (As show in Fig.5)

(2) Pretightening the union nut with hand.

(3) Adjust the torque force by referring to the following sheet. Place the open-end wrench on the pipe joint and place the torque wrench on the union nut. Tighten the union nut with torque wrench. (As show in Fig.6)

(4) Wrap the indoor pipe and joint of connection pipe with insulating pipe, and then wrap it with tape. (As show in Fig.7)

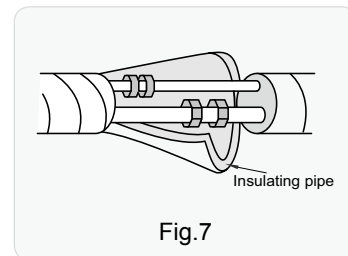
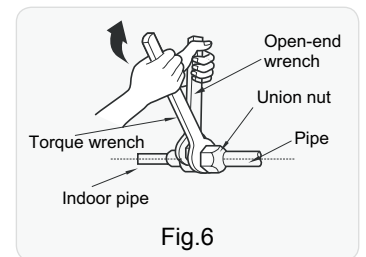
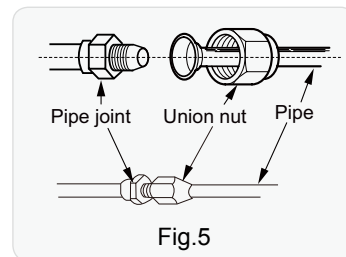

Refer to the following table for wrench moment of force:

Piping size	Tightening torque(N·m)
1/4"	15~20
3/8"	30~40
1/2"	45~55
5/8"	60~65
3/4"	70~75

6. Install Drain Hose

- (1) Connect the drain hose to the outlet pipe of indoor unit.(As show in Fig.8)
- (2) Bind the joint with tape.(As show in Fig.9)

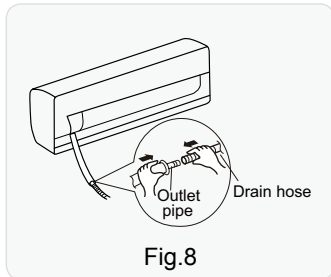

Fig.8

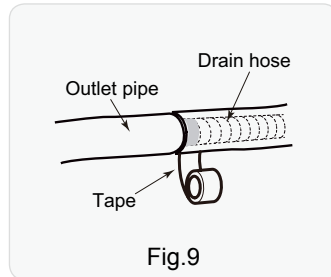

Fig.9

Note:

- (1) Add insulating pipe in the indoor drain hose in order to prevent condensation.
- (2) The plastic expansion particles are not provided.
(As show in Fig.10)

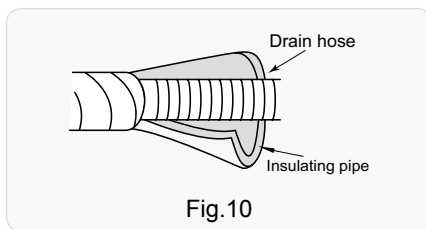

Fig.10

7. Connect Wire of Indoor Unit

- (1) Open the panel, remove the screw on the wiring cover and then take down the cover.(As show in Fig.11)

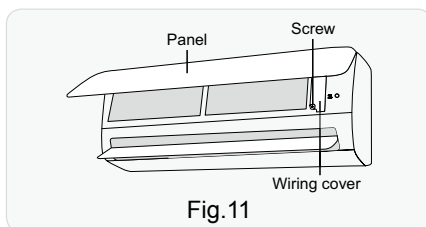

Fig.11

- (2) Make the power connection wire go through the cable-cross hole at the back of indoor unit and then pull it out from the front side.(As show in Fig.12)

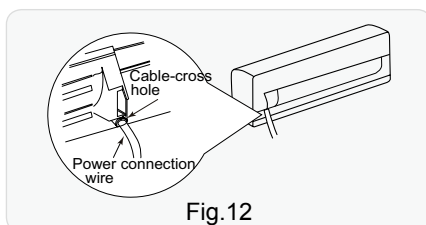

Fig.12

- (3) Remove the wire clip; connect the power connection wiresignal control wire (only for cooling and heating unit) to the wiring terminal according to the color; tighten the screw and then fix the power connection wire with wire clip.(As show in Fig.13)

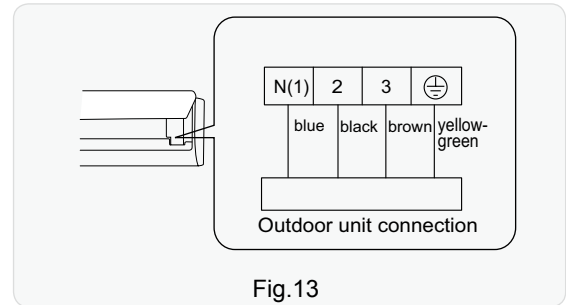

Fig.13

Note:The wiring connect is for reference only, please refer to the actual one.

- (4) Put wiring cover back and then tighten the screw.
- (5) Close the panel.

⚠ WARNING

- (1) All wires of indoor unit and outdoor unit should be connected by a professional.
- (2) If the length of power connection wire is insufficient, please contact the supplier for a new one. Avoid extending the wire by yourself.
- (3) For the air conditioner with plug, the plug should be reachable after finishing installation.
- (4) For the air conditioner without plug, an air switch must be installed in the line. The air switch should be all-pole parting and the contact parting distance should be more than 3mm.

8. Bind up Pipe

- (1) Bind up the connection pipe, power cord and drain hose with the band.(As show in Fig.14)
- (2) Reserve a certain length of drain hose and power cord for installation when binding them. When binding to a certain degree, separate the indoor power and then separate the drain hose.(As show in Fig.15)
- (3) Bind them evenly.
- (4) The liquid pipe and gas pipe should be bound separately at the end.

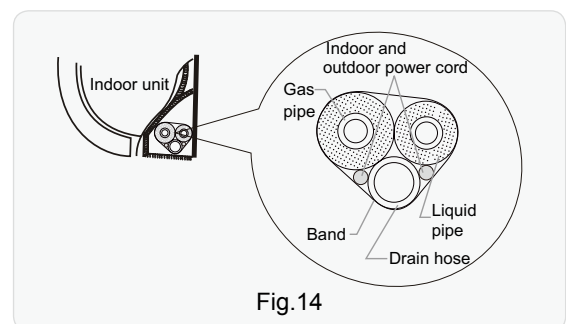

Fig.14

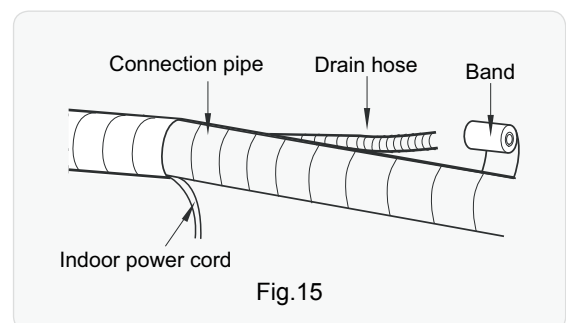

Fig.15

NOTICE

- (1) The power cord and control wire can't be crossed or winding.
- (2) The drain hose should be bound at the bottom.

9. Hang the Indoor Unit

- (1) Put the bound pipes in the wall pipe and then make them pass through the wall hole.
- (2) Hang the indoor unit on the wall-mounting frame.
- (3) Stuff the gap between pipes and wall hole with sealing gum.
- (4) Fix the wall pipe.(As show in Fig.16)
- (5) Check if the indoor unit is installed firmly and closed to the wall.(As show in Fig.17)

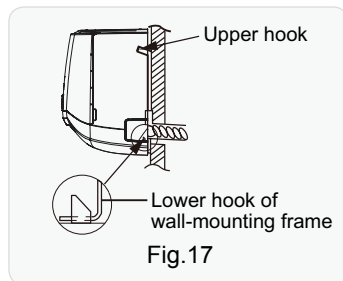
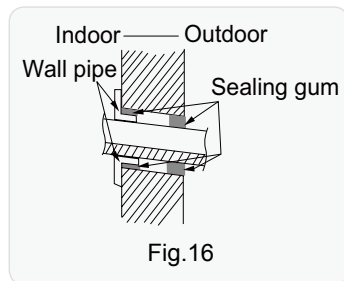

Note:

Do not bend the drain hose too excessively in order to prevent blocking.

8.6 Installation of Outdoor unit

1. Fix the Support of Outdoor Unit(Select it according to the actual installation situation)

- (1) Select installation location according to the house structure.
- (2) Fix the support of outdoor unit on the selected location with expansion screws.

Note:

- (1) Take sufficient protective measures when installing the outdoor unit.
- (2) Make sure the support can withstand at least four times the unit weight.
- (3) The outdoor unit should be installed at least 3cm above the floor in order to install drain joint.(As show in Fig.18)
- (4) For the unit with cooling capacity of 2300W~5000W, 6 expansion screws are needed; for the unit with cooling capacity of 6000W~8000W, 8 expansion screws are needed; for the unit with cooling capacity of 10000W~16000W, 10 expansion screws are needed.

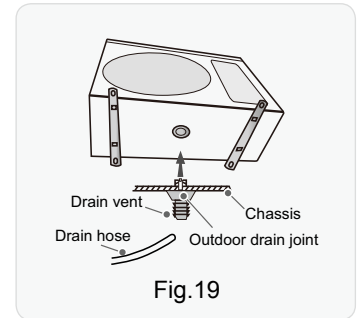
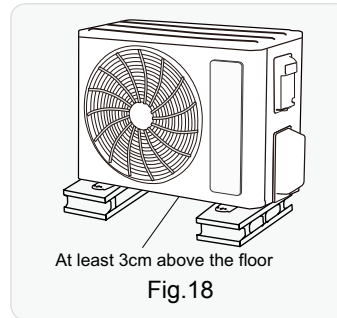

2. Install Drain Joint(Only for cooling and heating unit)

- (1) Connect the outdoor drain joint into the hole on the chassis.
 - (2) Connect the drain hose into the drain vent.
- (As show in Fig.19)

3. Fix Outdoor Unit

- (1) Place the outdoor unit on the support.
 - (2) Fix the foot holes of outdoor unit with bolts.
- (As show in Fig.20)

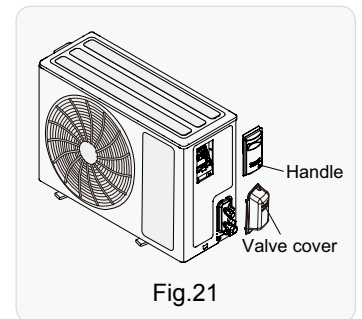
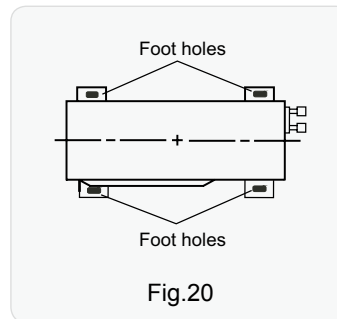

4. Connect Indoor and Outdoor Pipes

- (1) Remove the screws on the big handle and valve cover of outdoor unit, then remove them.(As show in Fig.21)
- (2) Remove the screw cap of valve and aim the pipe joint at the bellmouth of pipe.(As show in Fig.22)

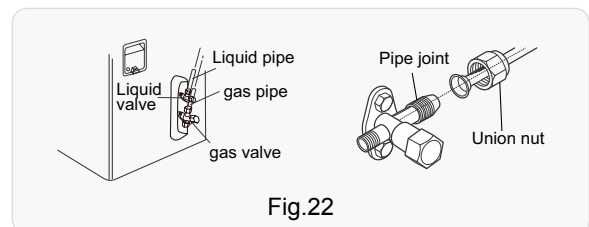

- (3) Pretightening the union nut with hand.
- (4) Tighten the union nut with torque wrench .

Refer to the following table for wrench moment of force:

Piping size	Tightening torque(N·m)
1/4"	15~20
3/8"	30~40
1/2"	45~55
5/8"	60~65
3/4"	70~75

5. Connect Outdoor Electric Wire

(1) Remove the wire clip; connect the power connection wire and signal control wire (only for cooling and heating unit) to the wiring terminal according to the color; fix them with screws.(As show in Fig.23)

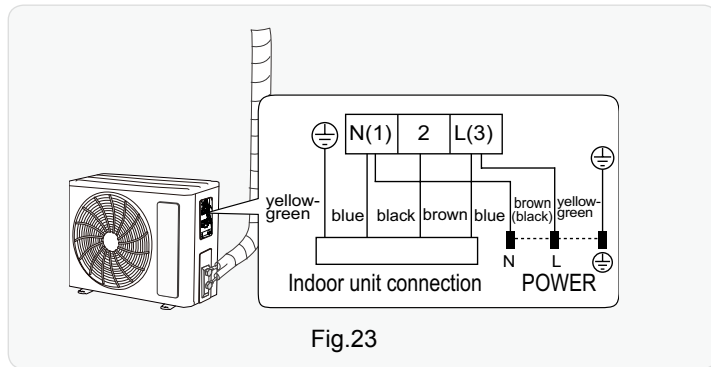

Fig.23

Note: the wiring connect is for reference only, please refer to the actual one.

(2) Fix the power connection wire and signal control wire with wire clip (only for cooling and heating unit).

⚠ CAUTION

- (1) After tightening the screw, pull the power cord slightly to check if it is firm.
- (2) Never cut the power connection wire to prolong or shorten the distance.

6. Neaten the Pipes

(1) The pipes should be placed along the wall, bent reasonably and hidden possibly. Min. semidiameter of bending the pipe is 10cm.

(2) If the outdoor unit is higher than the wall hole, you must set a U-shaped curve in the pipe before pipe goes into the room, in order to prevent rain from getting into the room.(As show in Fig.24)

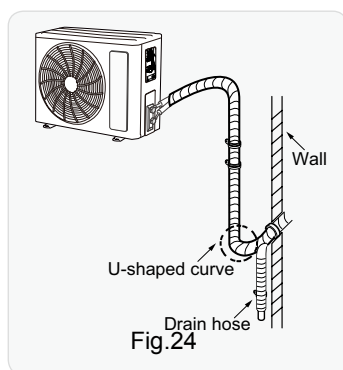

Fig.24

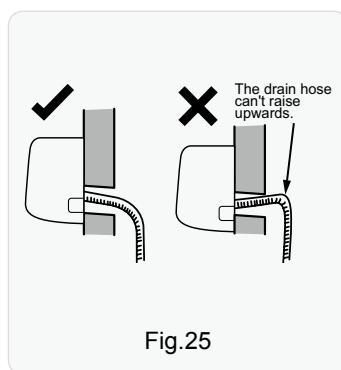

Fig.25

Note:

- (1) The through-wall height of drain hose shouldnt be higher than the outlet pipe hole of indoor unit.(As show in Fig.25)
- (2) Slant the drain hose slightly downwards. The drain hose can't be curved, raised and fluctuant, etc.(As show in Fig.26)
- (3) The water outlet can't be placed in water in order to drain smoothly.(As show in Fig.27)

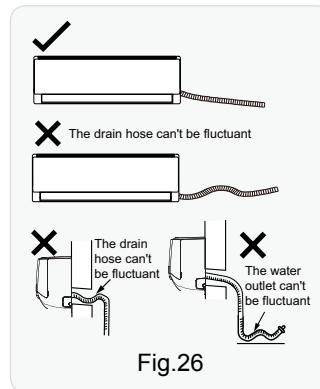

Fig.26



Fig.27

8.7 Vacuum Pumping and Leak Detection

1. Use Vacuum Pump

- (1) Remove the valve caps on the liquid valve and gas valve and the nut of refrigerant charging vent.
- (2) Connect the charging hose of piezometer to the refrigerant charging vent of gas valve and then connect the other charging hose to the vacuum pump.
- (3) Open the piezometer completely and operate for 10-15min to check if the pressure of piezometer remains in -0.1MPa .
- (4) Close the vacuum pump and maintain this status for 1-2min to check if the pressure of piezometer remains in -0.1MPa . If the pressure decreases, there may be leakage.
- (5) Remove the piezometer, open the valve core of liquid valve and gas valve completely with inner hexagon spanner.
- (6) Tighten the screw caps of valves and refrigerant charging vent.(As show in Fig.28)

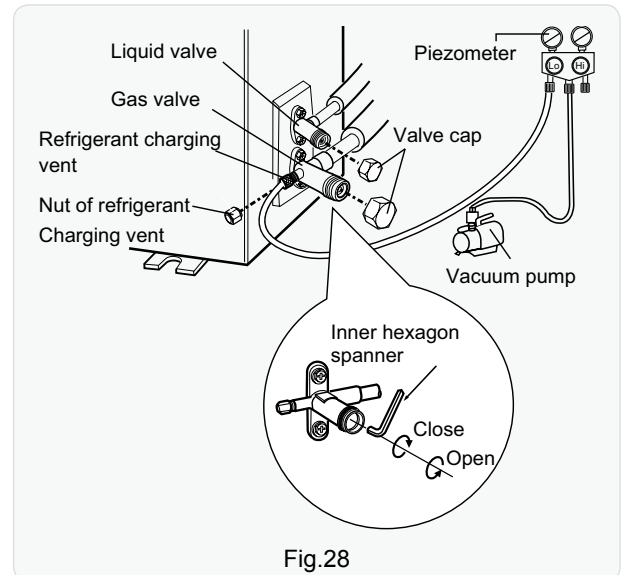

Fig.28

2. Leakage Detection

- (1) With leakage detector:
Check if there is leakage with leakage detector.

(2) With soap water:

If leakage detector is not available, please use soap water for leakage detection. Apply soap water at the suspected position and keep the soap water for more than 3min. If there are air bubbles coming out of this position, there's a leakage.

8.8 Check after Installation and Test operation

1. Check after Installation

Check according to the following requirement after finishing installation.

NO.	Items to be checked	Possible malfunction
1	Has the unit been installed firmly?	The unit may drop, shake or emit noise.
2	Have you done the refrigerant leakage test?	It may cause insufficient cooling (heating) capacity.
3	Is heat insulation of pipeline sufficient?	It may cause condensation and water dripping.
4	Is water drained well?	It may cause condensation and water dripping.
5	Is the voltage of power supply according to the voltage marked on the nameplate?	It may cause malfunction or damage the parts.
6	Is electric wiring and pipeline installed correctly?	It may cause malfunction or damage the parts.
7	Is the unit grounded securely?	It may cause electric leakage.
8	Does the power cord follow the specification?	It may cause malfunction or damage the parts.
9	Is there any obstruction in air inlet and air outlet?	It may cause insufficient cooling (heating) capacity.
10	The dust and sundries caused during installation are removed?	It may cause malfunction or damaging the parts.
11	The gas valve and liquid valve of connection pipe are open completely?	It may cause insufficient cooling (heating) capacity.
12	Is the inlet and outlet of piping hole been covered?	It may cause insufficient cooling(heating) capacity or waster eletricity.

2. Test Operation

(1) Preparation of test operation

- The client approves the air conditioner installation.
- Specify the important notes for air conditioner to the client.

(2) Method of test operation

- Put through the power, press ON/OFF button on the remote controller to start operation.
- Press MODE button to select AUTO, COOL, DRY, FAN and HEAT to check whether the operation is normal or not.
- If the ambient temperature is lower than 16°C, the air conditioner can't start cooling.



9. Maintenance

9.1 Error Code List



NOTE:



1. The fault of flash 2 times needs to enter the quick test mode before it can be displayed. (Under OFF status, press and hold the automatic button to power on, and the indoor unit enters the quick test mode)
2. For models with WiFi, the APP displays the fault code a few minutes after the failure.

Malfunction Name	Indicator display of indoor unit			APP display	A/C Status	Possible Causes(For specific maintenance method, please refer to the following procedure of troubleshooting)
	 (1 time/s)	 (1 time/s)	 (1 time/s)			
Jumper cap error protection	-	-	Flash 2 times	C5	The complete unit stops operation	See "Malfunction of Protection of Jumper Cap"
Communication error	-	Flash once	-	E6	Cool: compressor stops operation, while indoor fan operates; Heat: all loads stops operation.	See "Communication malfunction"
No feedback from motor of indoor unit	-	Flash 2 times	Flash 2 times	H6	The complete unit stops operation	1. Is the fan blocked? 2. Is the motor terminal loose? 3. Is the connection wire of motor damaged? 4. Is the motor damaged? 5. Is the control board of indoor unit is damaged?
Zero-crossing detection circuit error of PG motor (indoor fan)	Flash once	Flash once	Flash once	U8	Compressor, outdoor fan and indoor fan stop operation.	1. The power is abnormal; 2. Main board of indoor unit is damaged.
Indoor ambient temperature sensor is open-circuited or short-circuited	-	Flash 2 times	-	F1	Cool/Dry: indoor fan operates, while compressor stops operation; Heat: all loads stops operation.	1. The connection between the room temperature sensor and the control board AP1 of indoor unit is not good; 2. The room temperature sensor is damaged
Indoor evaporator is open-circuited or short-circuited	Flash 2 times	-	-	F2	Cool/Dry: indoor fan operates, while all other loads stops operation; Heat: all loads stops operation.	1. The connection between the tube temperature sensor and the control board of indoor unit is not good; 2. The tube temperature sensor is damaged
other errors that cause the unit to stop operation	Flash once	Flash once	Flash once	oE	Cool: compressor and outdoor fan stops operation, while indoor fan operates; Heat: compressor, outdoor fan and indoor fan stop operation.	1. Outdoor ambient temperature exceeds the operation range of unit (eg: less than-20°C or more than 60°C for cooling; more than 30°C for heating); 2. Are wires of compressor not connected tightly? 3. Failure startup of compressor? 4. Is compressor damaged? 5. Is main board damaged?
High pressure protection of system/ high pressure protection of compressor	Flash once	Flash once	Flash once	E1	Cool/Dry: all loads stops operation except indoor fan; Heat: all loads stops operation.	1. Heat exchange of unit is bad (including heat exchanger is dirty or the radiation environment for the unit is not good); 2. Ambient temperature is too high; 3. Too much refrigerant; 4. High-pressure switch is damaged.
Low pressure protection/ low pressure protection of system/ low pressure protection of compressor	Flash once	Flash once	Flash once	E3	Cool: compressor, outdoor fan and indoor fan stop operation; Heat: compressor and outdoor fan stop operation at first. About 1min later, indoor fan stops operation; 2mins later, the 4-way valve stop operation.	1. Low pressure switch is damaged; 2. Refrigerant inside the system is insufficient.

Malfunction Name	Indicator display of indoor unit			APP display	A/C Status	Possible Causes(For specific maintenance method, please refer to the following procedure of troubleshooting)
	 (1 time/s)	 (1 time/s)	 (1 time/s)			
Discharge high temperature protection/ compressor discharge protection/ discharge high temperature protection of compressor	Flash once	Flash once	Flash once	E4	Cool/Dry: compressor and outdoor fan stops operation, while indoor fan operates.	See "Overload protection of compressor , High discharge temperature protection of compressor"
Overcurrent protection/ overload protection/ overcurrent protection of compressor/ overload protection of compressor	Flash once	Flash once	Flash once	E5	Cool/Dry: compressor and outdoor fan stops operation, while indoor fan operates; Heat: all loads stops operation.	1. Power voltage is unstable; 2. Power voltage is too low; 3. Current is too high because the system load is too big.
Mode shock/ system mode shock	Flash once	Flash once	Flash once	E7	Load of indoor unit stops operation (indoor fan, E-heater, swing)	Malfunction of one-to-more system; there may be two indoor units which has set the shock mode, such as one is cooling and the other is heating.
Overload protection/high temperature protection/high temperature protection of system	Flash once	Flash once	Flash once	E8	Cool: compressor stops operation while indoor fan operates; Heat: all loads stops operation.	See "High temperature prevention protection; high power; system is abnormal"
Storage chip error/memory chip error	Flash once	Flash once	Flash once	EE	Cool/Dry: compressor stops operation, while indoor fan operates; Heat: all loads stops operation.	The control board of outdoor unit is damaged.
Refrigerant shortage protection or blockage protection	Flash once	Flash once	Flash once	F0	Cool: compressor and outdoor fan stops operation, while indoor fan operates; Heat: Compressor, outdoor fan and indoor fan stops operation.	1. Check whether the gas valve and the liquid valve of outdoor unit are opened completely; 2. Is the temperature sensor of evaporator if indoor unit is loose? 3. Is the temperature sensor of condenser of outdoor unit is loose? 4. Is refrigerant leaking? 5. Is the capillary or the electronic expansion valve is blocked? 6. Is the refrigerant leaking?
Outdoor ambient temperature sensor error/ outdoor ambient temperature sensor is open-circuited or short-circuited/ outdoor ambient temperature sensor error	Flash once	Flash once	Flash once	F3	Cool/Dry: compressor stops operation, while indoor fan operates; Heat: all loads stops operation.	1. Outdoor temperature sensor is not connected well or damaged 2. Temperature sensor wire of outdoor unit is damaged; short circuit between the temperature sensor and copper pipe or outer case 3. Main board of outdoor unit is damaged;

Malfunction Name	Indicator display of indoor unit			APP display	A/C Status	Possible Causes(For specific maintenance method, please refer to the following procedure of troubleshooting)
	 (1 time/s)	 (1 time/s)	 (1 time/s)			
Middle tube temperature sensor error of outdoor condenser	Flash once	Flash once	Flash once	F4	Cool/Dry: after operating for about 3mins, compressor stops operation, while indoor unit operates; Heat: after operating for 3mins, all loads stops operation.	1. Outtube temperature sensor is not connected well or damaged 2. Temperature sensor wire of outdoor unit is damaged; short circuit between the temperature sensor and copper pipe or outer case; 3. Main board of outdoor unit is damaged.
Outdoor discharge temperature sensor error	Flash once	Flash once	Flash once	F5	Complete unit stops operation; motor of sliding door is cut off power.	1. The exhaust temperature sensor is not connected well or damaged. 2. Temperature sensor wire of outdoor unit is damaged; short circuit between the temperature sensor and copper pipe or outer case 3. Main board of outdoor unit is damaged;
Overheating switch protection of compressor (CAC)/overload protection of compressor (RAC)	Flash once	Flash once	Flash once	H3	Cool/Dry: compressor stops operation, while indoor fan operates. Heat: all loads stops operation.	1. Overload wire of compressor is loose; 2. The overload protector is damaged. Under normal circumstances, the resistance between both ends of terminal is less than 1ohm. See "Overload protection of compressor , High discharge temperature protection of compressor"
IPM abnormality(CAC)/module protection (RAC)	Flash once	Flash once	Flash once	H5	Cool/Dry: compressor stops operation, while indoor fan operates. Heat: all loads stops operation.	See "IPM protection, over-phase current of compressor"
Non-synchronism protection, rotor position is not detected (CAC)/synchronism failure (RAC)	Flash once	Flash once	Flash once	H7	Cool/Dry: compressor stops operation, while indoor fan operates; Heat: all loads stops operation.	See "Desynchronization diagnosis for compressor"
IPM abnormality(CAC)/PFC protection (RAC)	Flash once	Flash once	Flash once	HC	Cool/Dry: compressor stops operation, while indoor fan operates; Heat: all loads stops operation.	1. Power plug of air conditioner or wiring board or reactor is not connected reliably; 2. The system is overload because evaporator or condenser is blocked by filth or dirt or air inlet and air outlet of indoor/outdoor unit is blocked by filth or dirt. 3. The power grid quality is bad; AC input voltage fluctuates sharply; 4. Main board of outdoor unit is damaged.
Compressor demagnetizing protection	Flash once	Flash once	Flash once	HE	Cool: compressor and outdoor fan stop operation; Heat: compressor and outdoor fan stop operation at first; about 1min later, indoor fan stops operation.	1. The main board of outdoor unit is damaged; 2. Compressor is damaged;
Startup failed	Flash once	Flash once	Flash once	Lc	Cool/Dry: compressor stops, while indoor fan operates; Heat: all loads stops operation.	See "Startup failed"
Phase loss, out-of-phase	Flash once	Flash once	Flash once	Ld	Cool: compressor and outdoor fan stop operation; Heat: compressor and outdoor fan stop operation at first; about 1min later, indoor fan stops operation.	1. The connection wire of compressor is not connected well; 2. The main board of outdoor unit is damaged; 3. The compressor is damaged;

Malfunction Name	Indicator display of indoor unit			APP display	A/C Status	Possible Causes(For specific maintenance method, please refer to the following procedure of troubleshooting)
	 (1 time/s)	 (1 time/s)	 (1 time/s)			
Indoor unit and outdoor unit can't match with each other	Flash once	Flash once	Flash once	LP	Heat: compressor, outdoor unit and indoor fan stops operation.	Capacity of indoor unit and outdoor unit can't be matched.
Compressor overcurrent detected by drive board	Flash once	Flash once	Flash once	P5	Cool/Dry: compressor stops operation, while indoor fan operates; Heat: all loads stops operation.	See "IPM protection, over-phase current of compressor"
Communication error between drive board and master control	Flash once	Flash once	Flash once	P6	Cool: compressor and outdoor fan stops operation; Heat: compressor and outdoor fan stop at first; about 1min later, indoor fan stops operation;	1. The driven board and the main board is not connected well; 2. The drive board is damaged; 3. The outdoor control board is damaged;
Radiator or IPM/PFC module temperature sensor error	Flash once	Flash once	Flash once	P7	Cool/Dry: compressor stops operation, while indoor fan operates; Heat: all loads stops operation.	Replace outdoor control board
High temperature of radiator or IPM,/PFC module	Flash once	Flash once	Flash once	P8	Cool: compressor stops operation, while indoor fan operates; Heat: all loads stops operation.	1. Air inlet and air outlet of outdoor unit are blocked by filth or dirt; 2. Condenser of outdoor unit is blocked by filth or dirt; 3. IPM screw of main board is not tightened; 4. Main board of outdoor unit is damaged;
Ambient temperature sensor error on drive board	Flash once	Flash once	Flash once	PF	Cool: compressor, outdoor fan and indoor fan stop operation; Heat: compressor and outdoor fan stop operation at first; about 1min later, indoor fan stops operation.	1. The ambient temperature sensor of the drive board is not connected well; 2. Malfunction of the ambient temperature sensor of drive board.
DC input voltage is too high	Flash once	Flash once	Flash once	PH	Cool/Dry: compressor stops operation, while indoor fan operates; Heat: all loads stops operation.	1. Measure the voltage between position L and position N on the wiring board (XT). If it's higher than 265 VAC, please turn on the unit until the power voltage is decreased to the normal range; 2. If the AC input is normal, please replace the outdoor control board.
DC input voltage is too low	Flash once	Flash once	Flash once	PL	Cool/Dry: compressor stops operation, while indoor fan operates; Heat: all loads stops operation.	1. Measure the voltage between position L and position N on the wiring board (XT). If it's lower than 150 VAC, please turn on the unit until the power voltage is increased to the normal range; 2. If the AC input is normal, please replace the outdoor control board.
Charging circuit error of big electrolytic capacitor	Flash once	Flash once	Flash once	PU	Cool/Dry: compressor stops operation, while indoor fan operates; Heat: all loads stops operation.	See "Charging malfunction of capacitor"
DC bus voltage drop	Flash once	Flash once	Flash once	U3	Cool/Dry: compressor stops operation, while indoor fan operates; Heat: all loads stops operation.	The power voltage is unstable.
Phase current detection circuit error of compressor	Flash once	Flash once	Flash once	U1	Cool: compressor and outdoor fan stops operation, while indoor fan operates; Heat: compressor, outdoor fan and indoor fan stops operation.	The control board is damaged

Malfunction Name	Indicator display of indoor unit			APP display	A/C Status	Possible Causes(For specific maintenance method, please refer to the following procedure of troubleshooting)
	 (1 time/s)	 (1 time/s)	 (1 time/s)			
High power protection	Flash once	Flash once	Flash once	L9	Cool: compressor and outdoor fan stops operation, while indoor fan operates.	See "High temperature prevention protection; high power; system isabnormal"
4-way valve commuting error protection	Flash once	Flash once	Flash once	U7	This malfunction occurs when the unit is heating. All loads stops operation.	1. Power voltage is lower than AC175V; 2. Wiring terminal of 4-way valve is loose or broken; 3. 4-way valve is damaged. Replace the 4-way valve.
DC fan error/ outdoor fan error protection	Flash once	Flash once	Flash once	L3	Cool/Dry: all loads stops operation except indoor fan. Heat: all loads stops operation.	1. Outdoor condenser, air inlet and air outlet are blocked by filth or dirt; 2.Fan is blocked or loosened; 3.Motor or connection wire of motor is damaged; 4.Main board of outdoor unit is damaged; (As for dual-outdoor fan, L3 indicates fan 1; LA indicates fan 2)
Outdoor fan error protection	Flash once	Flash once	Flash once	LA		
Current detection error of complete unit	Flash once	Flash once	Flash once	U5	Cool: compressor and outdoor fan stops operation, while indoor fan operates; Heat: compressor, outdoor fan and indoor fan stops operation.	1. Is the complete unit lacking of refrigerant? 2. There's malfunction for the circuit of control board of outdoor unit. Replace the control board of outdoor unit.
System abnormality	Flash once	Flash once	Flash once	H4	Cool/Dry: all loads stops operation except indoor fan; Heat: all loads stops operation.	See "High temperature prevention protection; high power; system isabnormal"

Analysis or processing of some of the malfunction display:

1. Compressor discharge protection

Possible causes: shortage of refrigerant; blockage of air filter; poor ventilation or air flow short pass for condenser; the system has noncondensable gas (such as air, water etc.); blockage of capillary assy (including filter); leakage inside four-way valve causes incorrect operation; malfunction of compressor; malfunction of protection relay; malfunction of discharge sensor; outdoor temperature too high.

Processing method: refer to the malfunction analysis in the above section.

2. Low voltage overcurrent protection

Possible cause: Sudden drop of supply voltage.

3.Communication malfunction

Processing method: Check if communication signal cable is connected reliably.

4. Sensor open or short circuit

Processing method: Check whether sensor is normal, connected with the corresponding position on the controller and if damage of lead wire is found.

5. Compressor over load protection

Possible causes: insufficient or too much refrigerant; blockage of capillary and increase of suction temp.; improper running of compressor, burning in or stuck of bearing, damage of discharge valve; malfunction of protector.

Processing method: adjust refrigerant amount; replace the capillary; replace the compressor; use universal meter to check if the contactor of compress or is fine when it is not overheated, if not replace the protector.

6. System malfunction

i.e. overload protection. When tube temperature(Check the temperature of outdoor heat exchanger when cooling and check the temperature of indoor heat exchanger when heating) is too high, protection will be activated.

Possible causes: Outdoor temperature is too high when cooling; insufficient outdoor air circulation; refrigerant flow malfunction.

please refer to the malfunction analysis in the previous section for handling method .

7. IPM module protection

Processing method: Once the module malfunction happens,if it persists for a long time and can not be selfcanceled, cut off the power and turn off the unit,and then re-energize the unit again after about 10 min. After repeating the procedure for sever times, if the malfunction still exists,replace the module.

9.2 Procedure of Troubleshooting

•Indoor unit:

1. Malfunction of Temperature Sensor F1/F2

Main detection points:

(1) connection terminal (2) temperature sensor (3) main board

Malfunction diagnosis process:

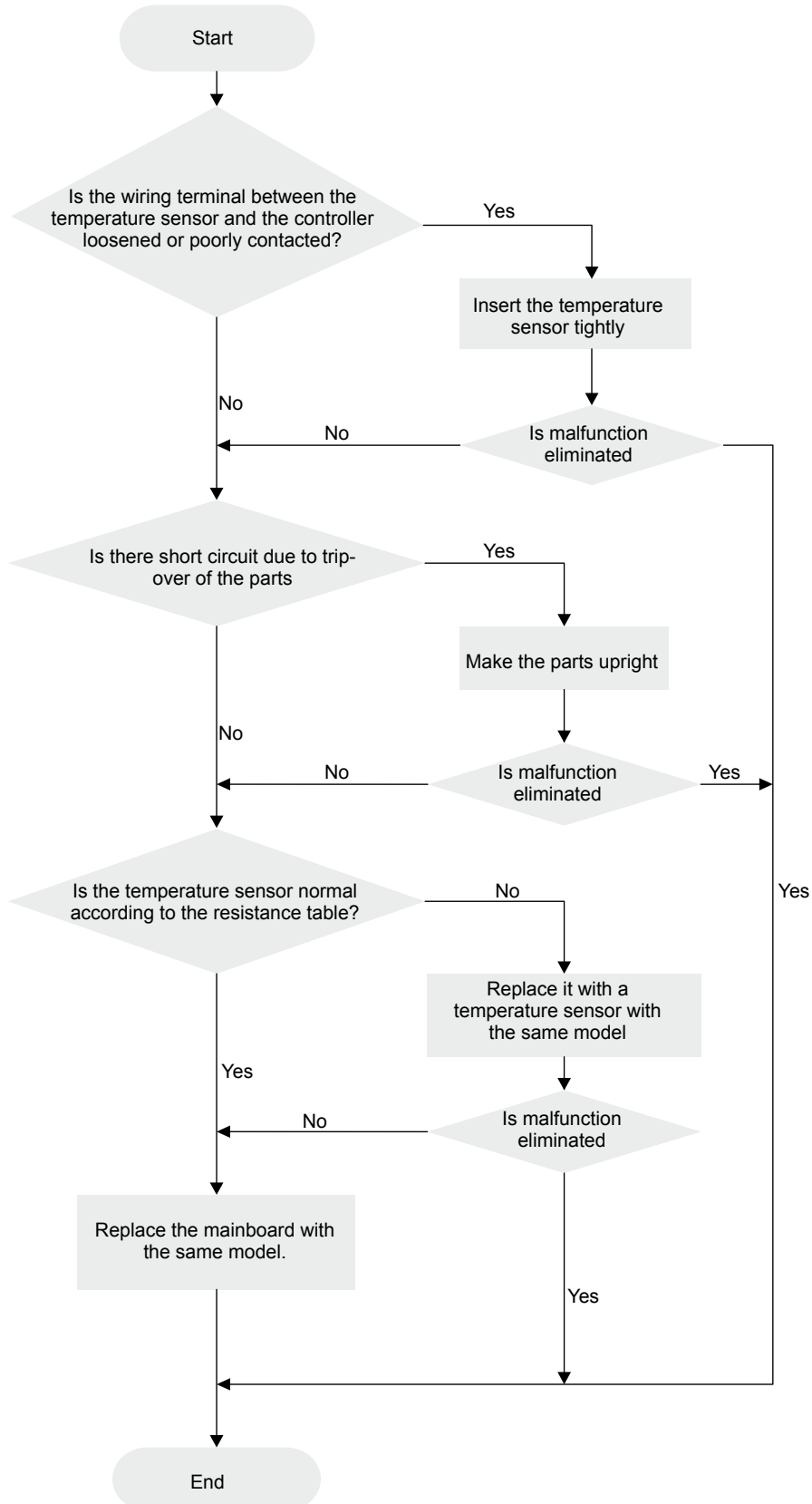

2. Malfunction of Blocked Protection of IDU Fan Motor H6

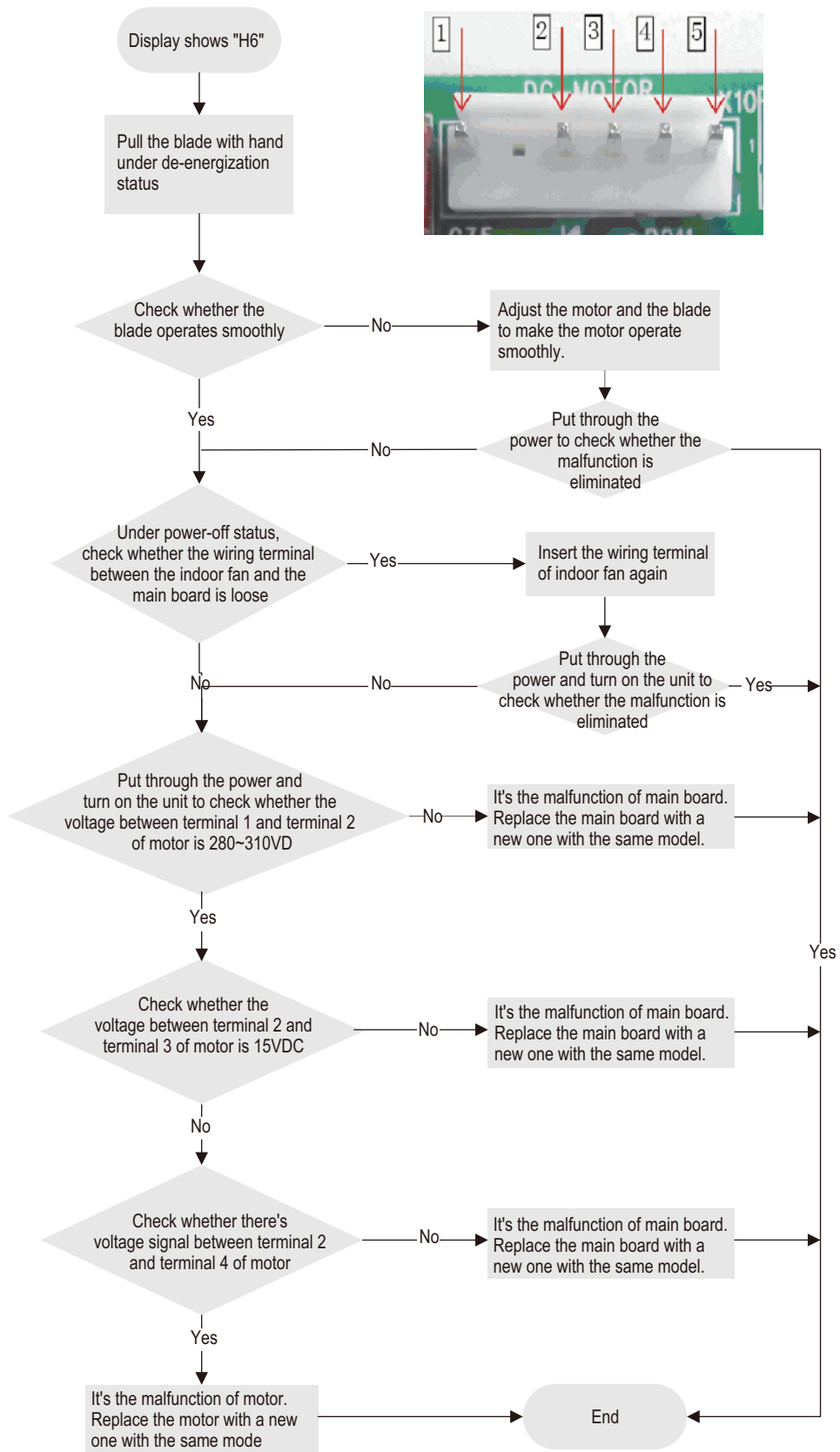

End

3. Malfunction of Protection of Jumper Cap C5

Main detection points:

(1) jumper cap (2) control board of indoor unit

Malfunction diagnosis process:

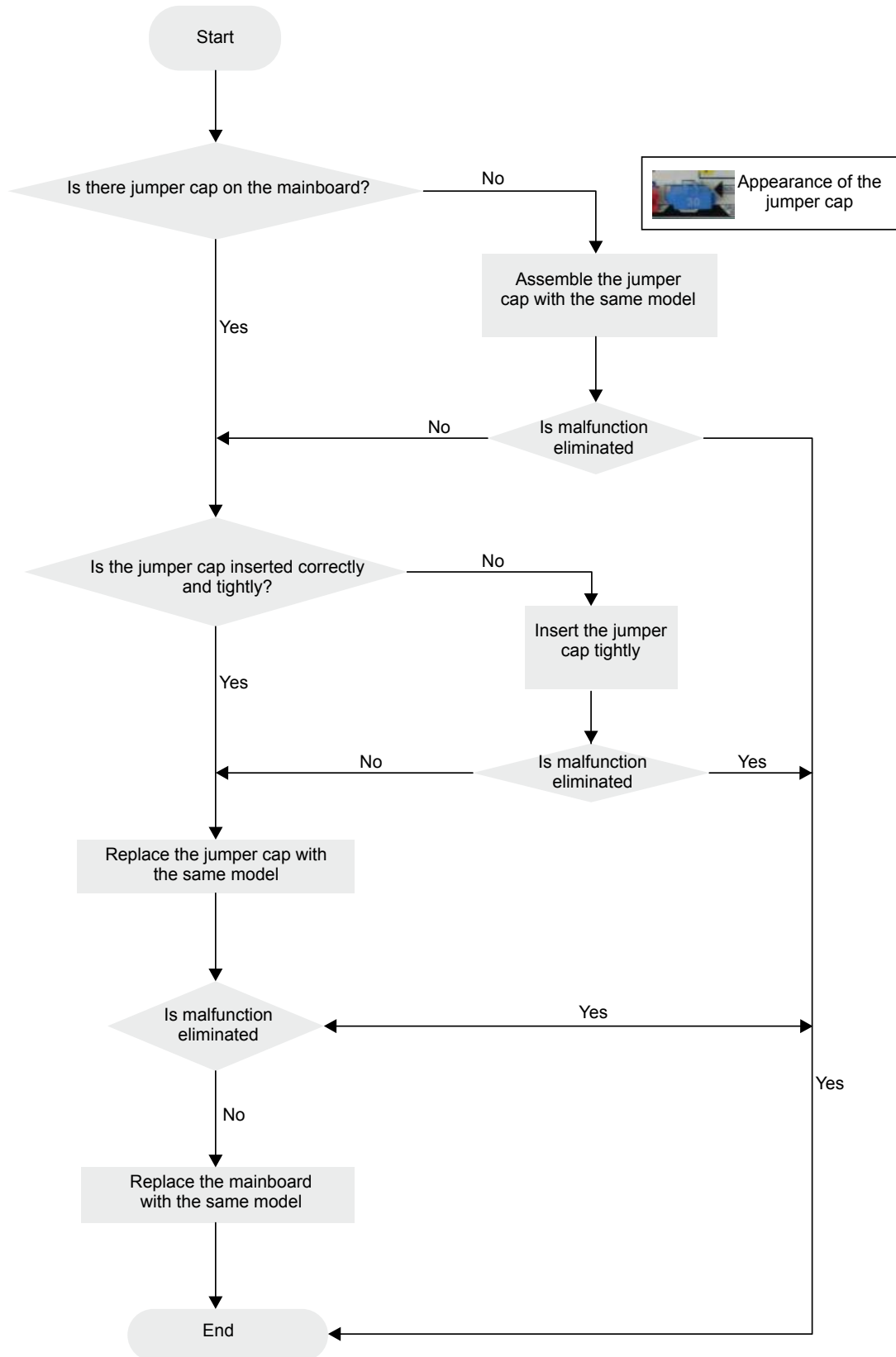

4. Communication malfunction E6

Mainly detect:

- (1) Connection wire between indoor unit and outdoor unit
- (2) Wiring inside the unit
- (3) Communication circuit of control board of indoor unit
- (4) Communication circuit of control board of outdoor unit damage?

Malfunction diagnosis process:

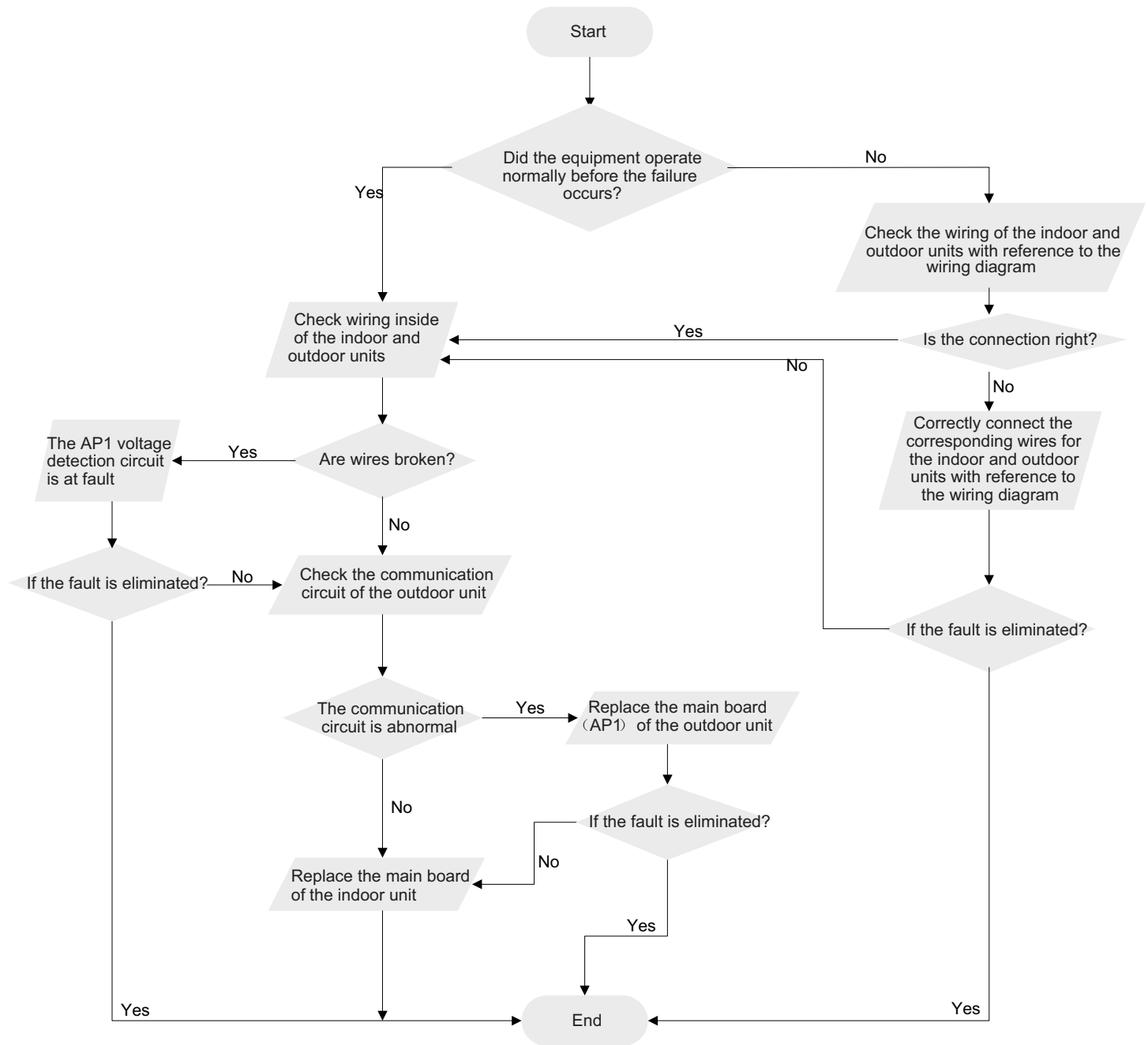

Note: method for checking the communication circuit of inverter split type and floor standing unit: cut off the communication wires of indoor/outdoor unit, and then measure the voltage between COM and N of the control board of outdoor unit (DC notch, about 56V)

4. Malfunction of Zero-crossing Inspection Circuit Malfunction of the IDU Fan Motor U8

Main detection points:

(1)Power supply (2)control board of indoor unit

Malfunction diagnosis process:

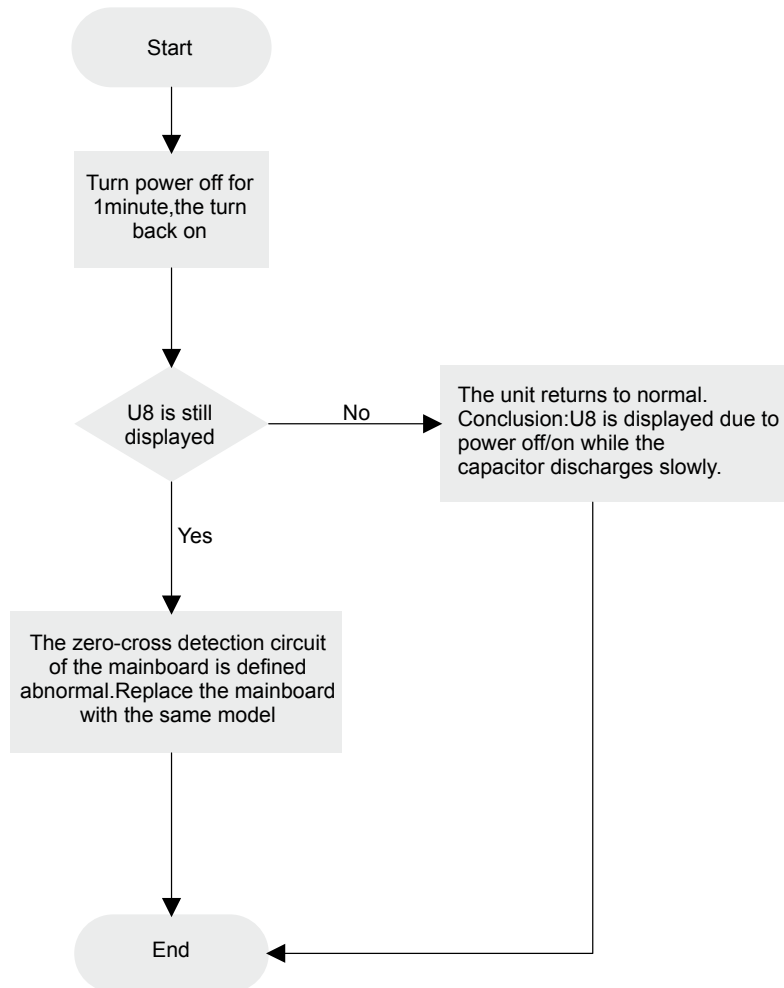

●Outdoor unit:

5. High temperature E8, overload, high power L9 and system is abnormal H4 (AP1 below means control board of outdoor unit)

Main check points:

(1) outdoor temperature (2) fan (3)air inlet and air outlet of indoor/outdoor unit

Malfunction diagnosis process:

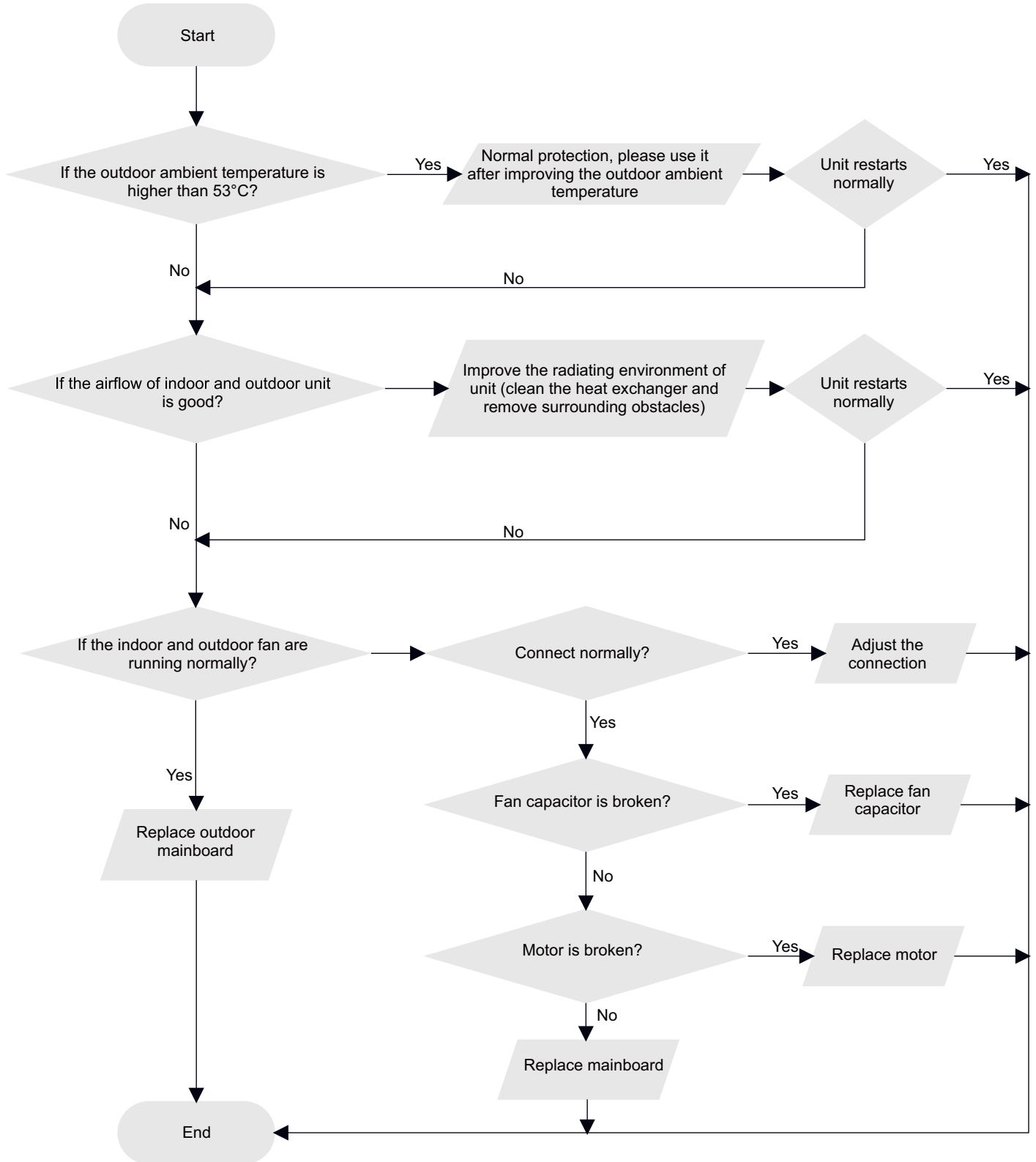

6. IPM protection H5, phase current overcurrent P5 (the control board as below indicates the control board of outdoor unit)

Mainly detect:

- (1) Compressor COMP terminal (2) voltage of power supply (3) compressor
- (4) Refrigerant-charging volume (5) air outlet and air inlet of outdoor/indoor unit

Malfunction diagnosis process:

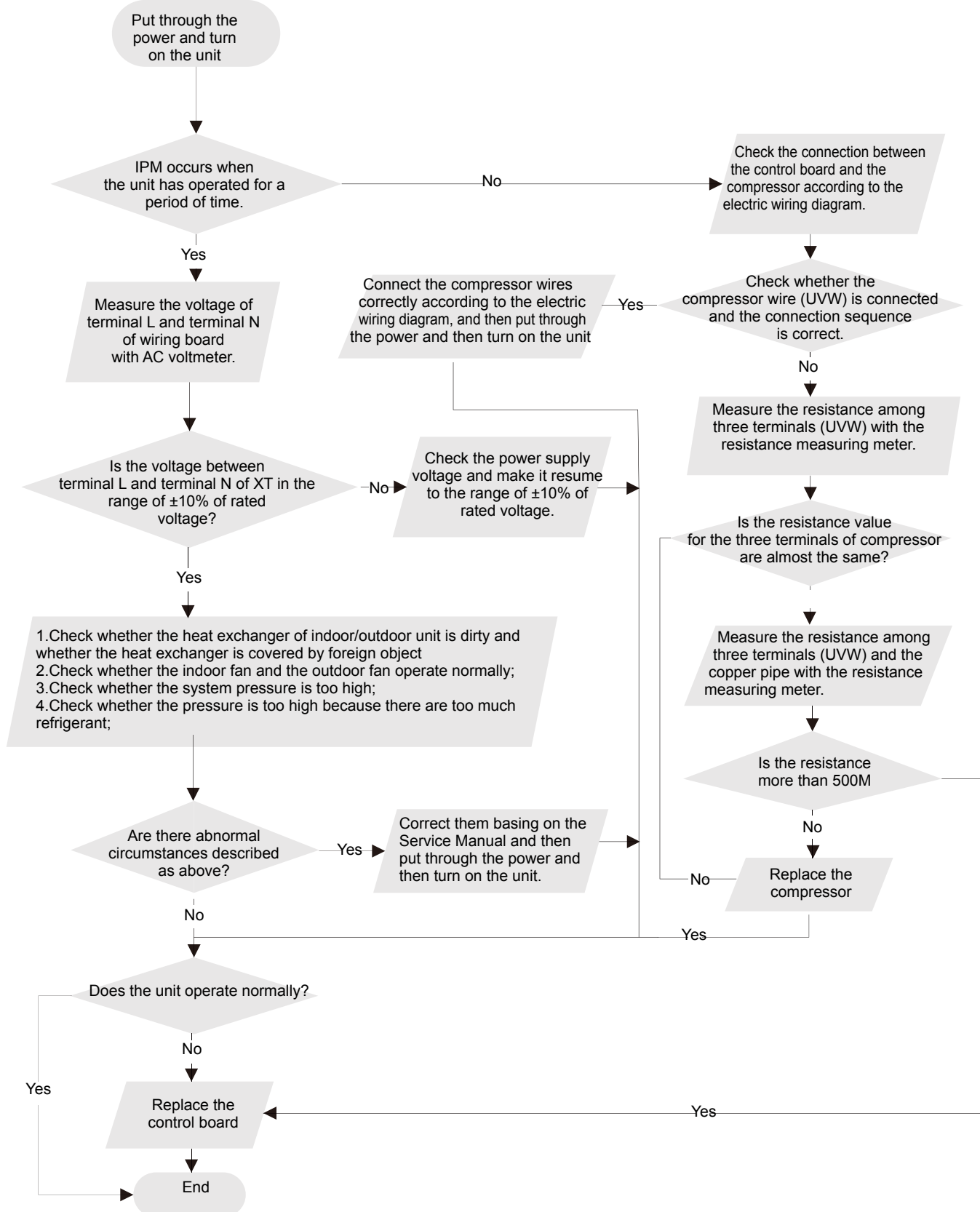

7. Desynchronization diagnosis for compressor H7 (AP1 hereinafter refers to the control board of the outdoor unit)

Mainly detect:

(1) system pressure (2) power supply voltage

Malfunction diagnosis process:

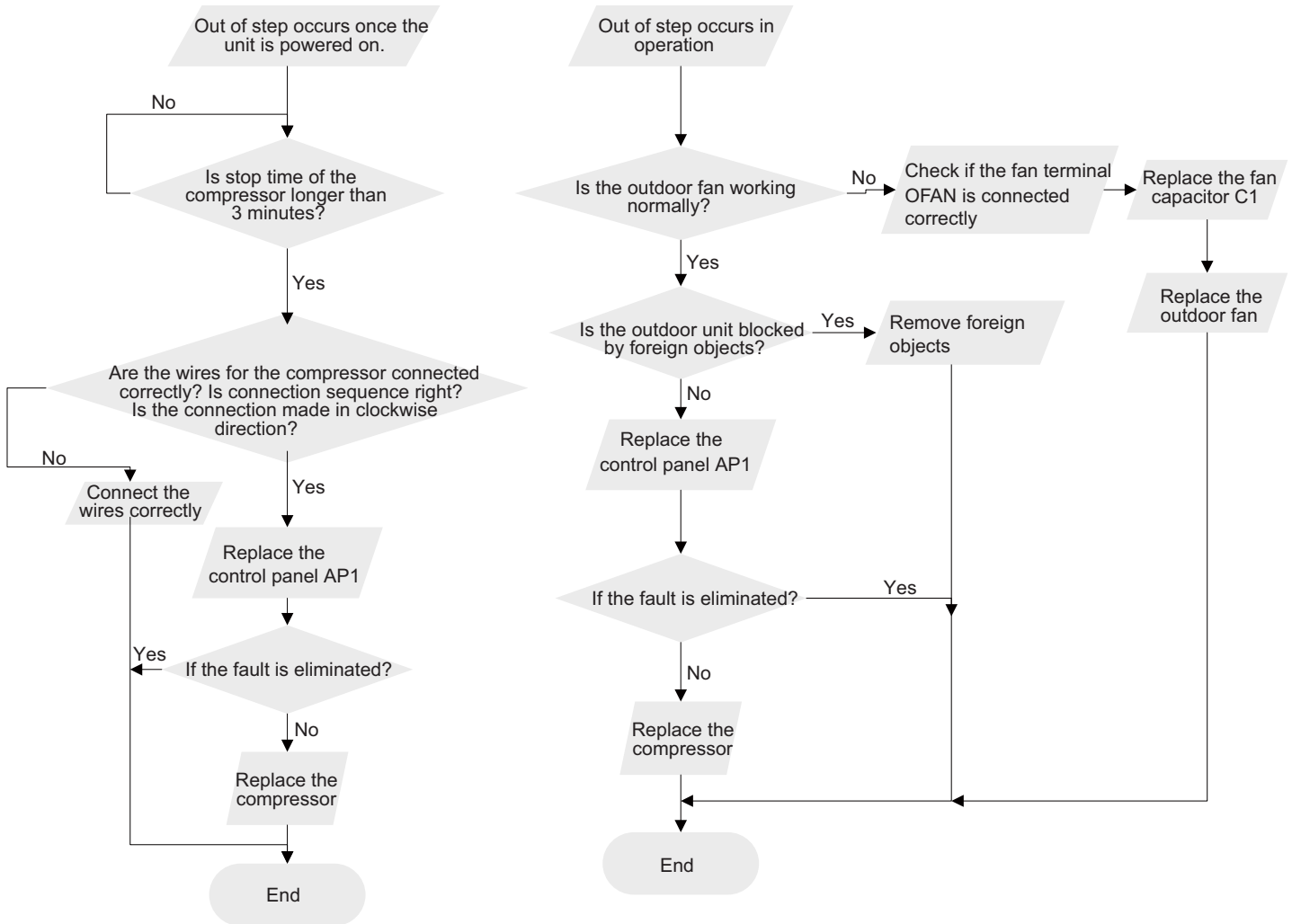

8. Charging malfunction of capacitor PU (AP1 below means control board of outdoor unit)

Main detection points:

(1) wiring board XT (2) reactor

Malfunction diagnosis process:

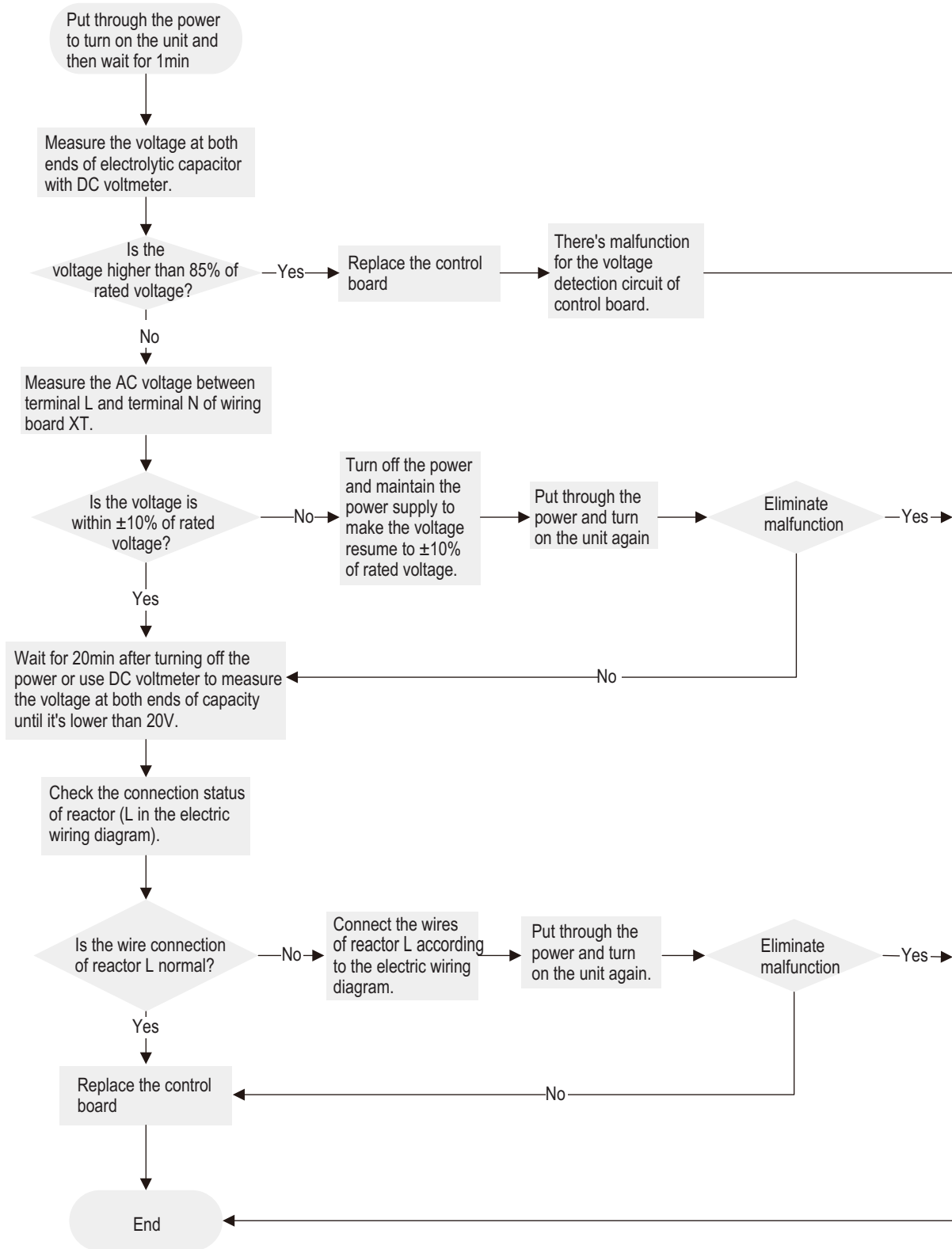

9. Malfunction of Overcurrent Protection E5

Main detection points:

- Is the supply voltage unstable with big fluctuation?
- Is the supply voltage too low with overload?
- Hardware trouble?

Malfunction diagnosis process:

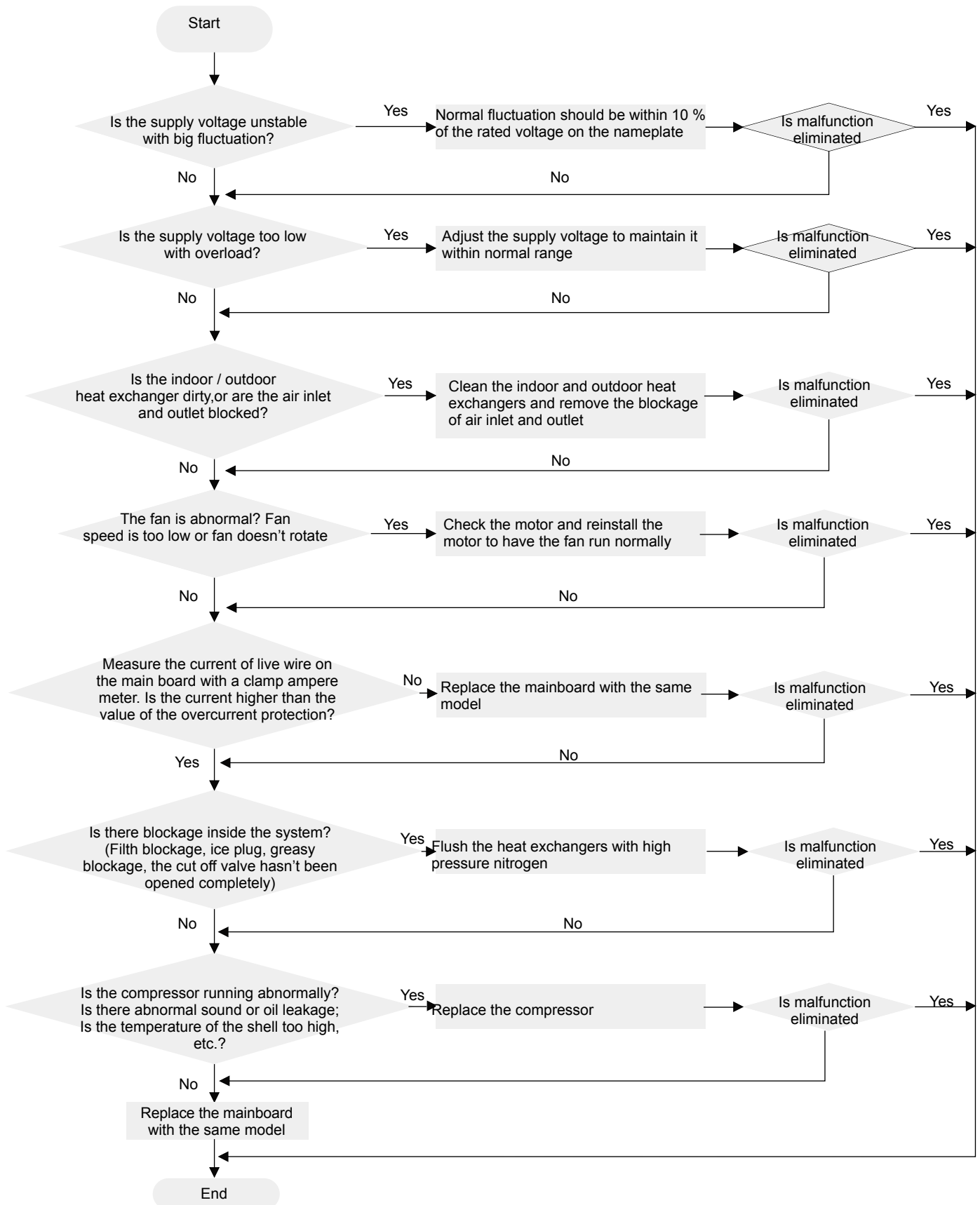

10. Startup failed Lc (following AP1 for outdoor unit control board)

Main detection points:

(1) compressor wire (2) compressor (3) charging amount of refrigerant

Malfunction diagnosis process:

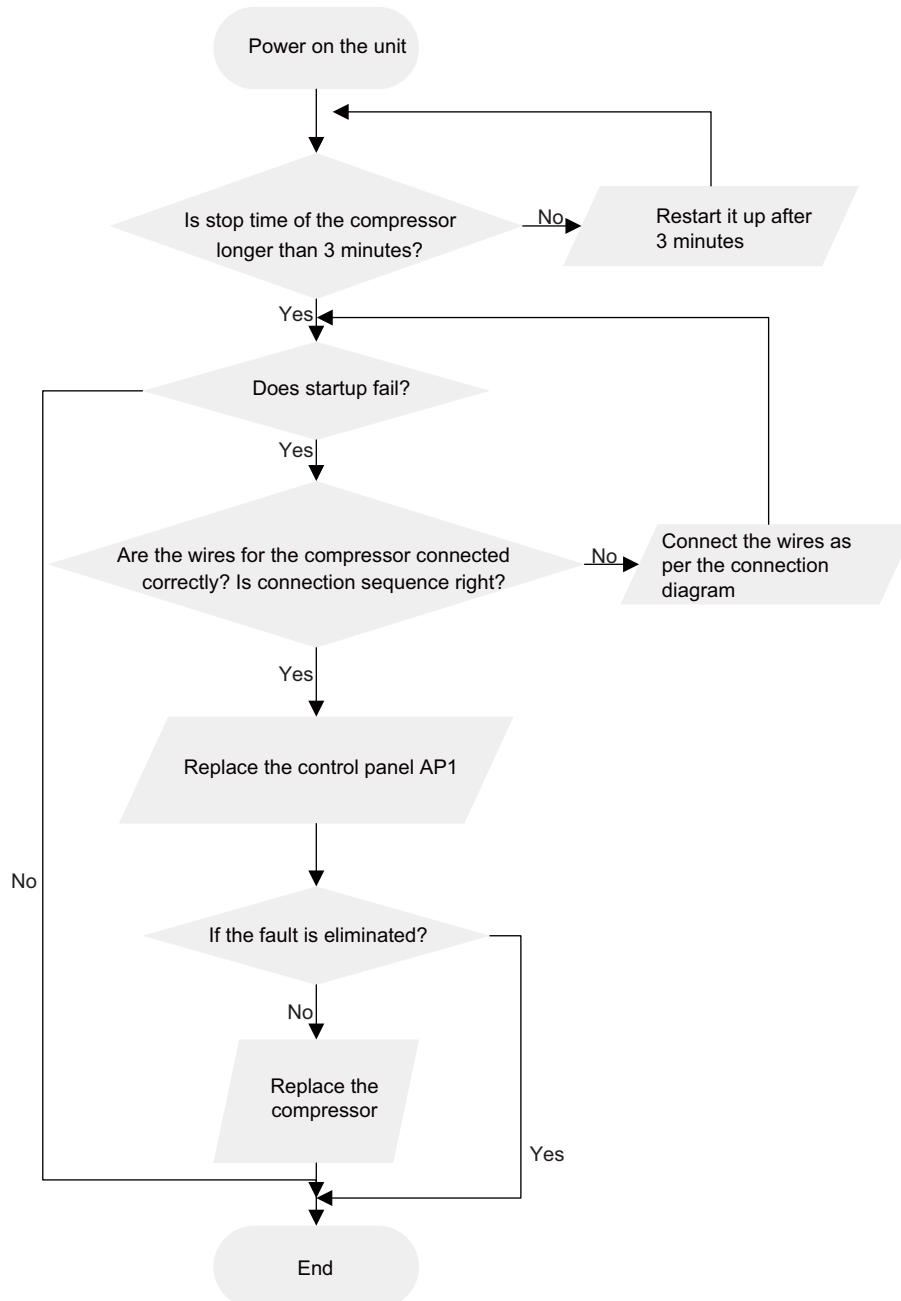

11. Overload protection of compressor H3, high discharge temperature protection of compressor E4 (AP1 hereinafter refers to the control board of the outdoor unit)

Main detection points:

(1) electronic expansion valve (2) expansion valve terminal (3) charging amount of refrigerant (4) overload protector

Malfunction diagnosis process:

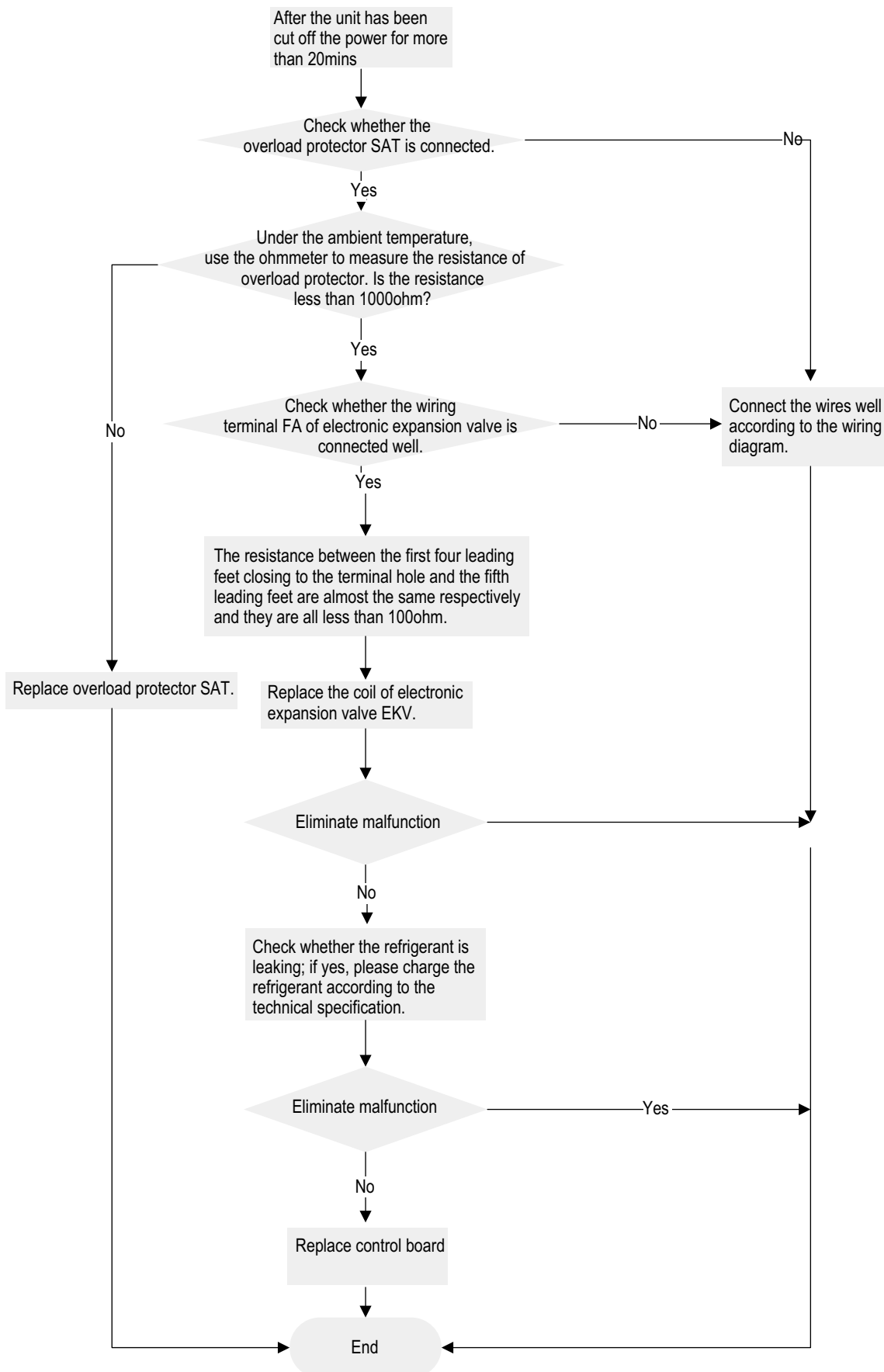

9.3 Troubleshooting for Normal Malfunction

1. Air Conditioner Can't be Started Up

Possible Causes	Discriminating Method (Air conditioner Status)	Troubleshooting
No power supply, or poor connection for power plug	After energization, operation indicator isn't bright and the buzzer can't give out sound	Confirm whether it's due to power failure. If yes, wait for power recovery. If not, check power supply circuit and make sure the power plug is connected well.
Wrong wire connection between indoor unit and outdoor unit, or poor connection for wiring terminals	Under normal power supply circumstances, operation indicator isn't bright after energization	Check the circuit according to circuit diagram and connect wires correctly. Make sure all wiring terminals are connected firmly
Electric leakage for air conditioner	After energization, room circuit breaker trips off at once	Make sure the air conditioner is grounded reliably Make sure wires of air conditioner is connected correctly Check the wiring inside air conditioner. Check whether the insulation layer of power cord is damaged; if yes, place the power cord.
Model selection for air switch is improper	After energization, air switch trips off	Select proper air switch
Malfunction of remote controller	After energization, operation indicator is bright, while no display on remote controller or buttons have no action.	Replace batteries for remote controller Repair or replace remote controller

2. Poor Cooling (Heating) for Air Conditioner

Possible Causes	Discriminating Method (Air conditioner Status)	Troubleshooting
Set temperature is improper	Observe the set temperature on remote controller	Adjust the set temperature
Rotation speed of the IDU fan motor is set too low	Small wind blow	Set the fan speed at high or medium
Filter of indoor unit is blocked	Check the filter to see its blocked	Clean the filter
Installation position for indoor unit and outdoor unit is improper	Check whether the installation position is proper according to installation requirement for air conditioner	Adjust the installation position, and install the rainproof and sunproof for outdoor unit
Refrigerant is leaking	Discharged air temperature during cooling is higher than normal discharged wind temperature; Discharged air temperature during heating is lower than normal discharged wind temperature; Units pressure is much lower than regulated range	Find out the leakage causes and deal with it. Add refrigerant.
Malfunction of 4-way valve	Blow cold wind during heating	Replace the 4-way valve
Malfunction of capillary	Discharged air temperature during cooling is higher than normal discharged wind temperature; Discharged air temperature during heating is lower than normal discharged wind temperature; Unit pressure is much lower than regulated range. If refrigerant isn't leaking, part of capillary is blocked	Replace the capillary
Flow volume of valve is insufficient	The pressure of valves is much lower than that stated in the specification	Open the valve completely
Malfunction of horizontal louver	Horizontal louver can't swing	Refer to point 3 of maintenance method for details
Malfunction of the IDU fan motor	The IDU fan motor can't operate	Refer to troubleshooting for H6 for maintenance method in details
Malfunction of the ODU fan motor	The ODU fan motor can't operate	Refer to point 4 of maintenance method for details
Malfunction of compressor	Compressor can't operate	Refer to point 5 of maintenance method for details

3. Horizontal Louver can't Swing

Possible Causes	Discriminating Method (Air conditioner Status)	Troubleshooting
Wrong wire connection, or poor connection	Check the wiring status according to circuit diagram	Connect wires according to wiring diagram to make sure all wiring terminals are connected firmly
Stepping motor is damaged	Stepping motor can't operate	Repair or replace stepping motor
Main board is damaged	Others are all normal, while horizontal louver can't operate	Replace the main board with the same model

4. ODU Fan Motor can't Operate

Possible causes	Discriminating method (air conditioner status)	Troubleshooting
Wrong wire connection, or poor connection	Check the wiring status according to circuit diagram	Connect wires according to wiring diagram to make sure all wiring terminals are connected firmly
Capacity of the ODU fan motor is damaged	Measure the capacity of fan capacitor with an universal meter and find that the capacity is out of the deviation range indicated on the nameplate of fan capacitor.	Replace the capacity of fan
Power voltage is a little low or high	Use universal meter to measure the power supply voltage. The voltage is a little high or low	Suggest to equip with voltage regulator
Motor of outdoor unit is damaged	When unit is on, cooling/heating performance is bad and ODU compressor generates a lot of noise and heat.	Change compressor oil and refrigerant. If no better, replace the compressor with a new one

5. Compressor can't Operate

Possible causes	Discriminating method (air conditioner status)	Troubleshooting
Wrong wire connection, or poor connection	Check the wiring status according to circuit diagram	Connect wires according to wiring diagram to make sure all wiring terminals are connected firmly
Capacity of compressor is damaged	Measure the capacity of fan capacitor with an universal meter and find that the capacity is out of the deviation range indicated on the nameplate of fan capacitor.	Replace the compressor capacitor
Power voltage is a little low or high	Use universal meter to measure the power supply voltage. The voltage is a little high or low	Suggest to equip with voltage regulator
Coil of compressor is burnt out	Use universal meter to measure the resistance between compressor terminals and its 0	Repair or replace compressor
Cylinder of compressor is blocked	Compressor can't operate	Repair or replace compressor

6. Air Conditioner is Leaking

Possible causes	Discriminating method (air conditioner status)	Troubleshooting
Drain pipe is blocked	Water leaking from indoor unit	Eliminate the foreign objects inside the drain pipe
Drain pipe is broken	Water leaking from drain pipe	Replace drain pipe
Wrapping is not tight	Water leaking from the pipe connection place of indoor unit	Wrap it again and bundle it tightly

7. Abnormal Sound and Vibration

Possible causes	Discriminating method (air conditioner status)	Troubleshooting
When turn on or turn off the unit, the panel and other parts will expand and there's abnormal sound	Theres the sound of "PAPA"	Normal phenomenon. Abnormal sound will disappear after a few minutes.
When turn on or turn off the unit, there's abnormal sound due to flow of refrigerant inside air conditioner	Water-running sound can be heard	Normal phenomenon. Abnormal sound will disappear after a few minutes.
Foreign objects inside the indoor unit or therere parts touching together inside the indoor unit	Theres abnormal sound fro indoor unit	Remove foreign objects. Adjust all parts position of indoor unit, tighten screws and stick damping plaster between connected parts
Foreign objects inside the outdoor unit or therere parts touching together inside the outdoor unit	Theres abnormal sound fro outdoor unit	Remove foreign objects. Adjust all parts position of outdoor unit, tighten screws and stick damping plaster between connected parts
Short circuit inside the magnetic coil	During heating, the way valve has abnormal electromagnetic sound	Replace magnetic coil
Abnormal shake of compressor	Outdoor unit gives out abnormal sound	Adjust the support foot mat of compressor, tighten the bolts
Abnormal sound inside the compressor	Abnormal sound inside the compressor	If add too much refrigerant during maintenance, please reduce refrigerant properly. Replace compressor for other circumstances.

10. Exploded View and Parts List

10.1 Indoor Unit

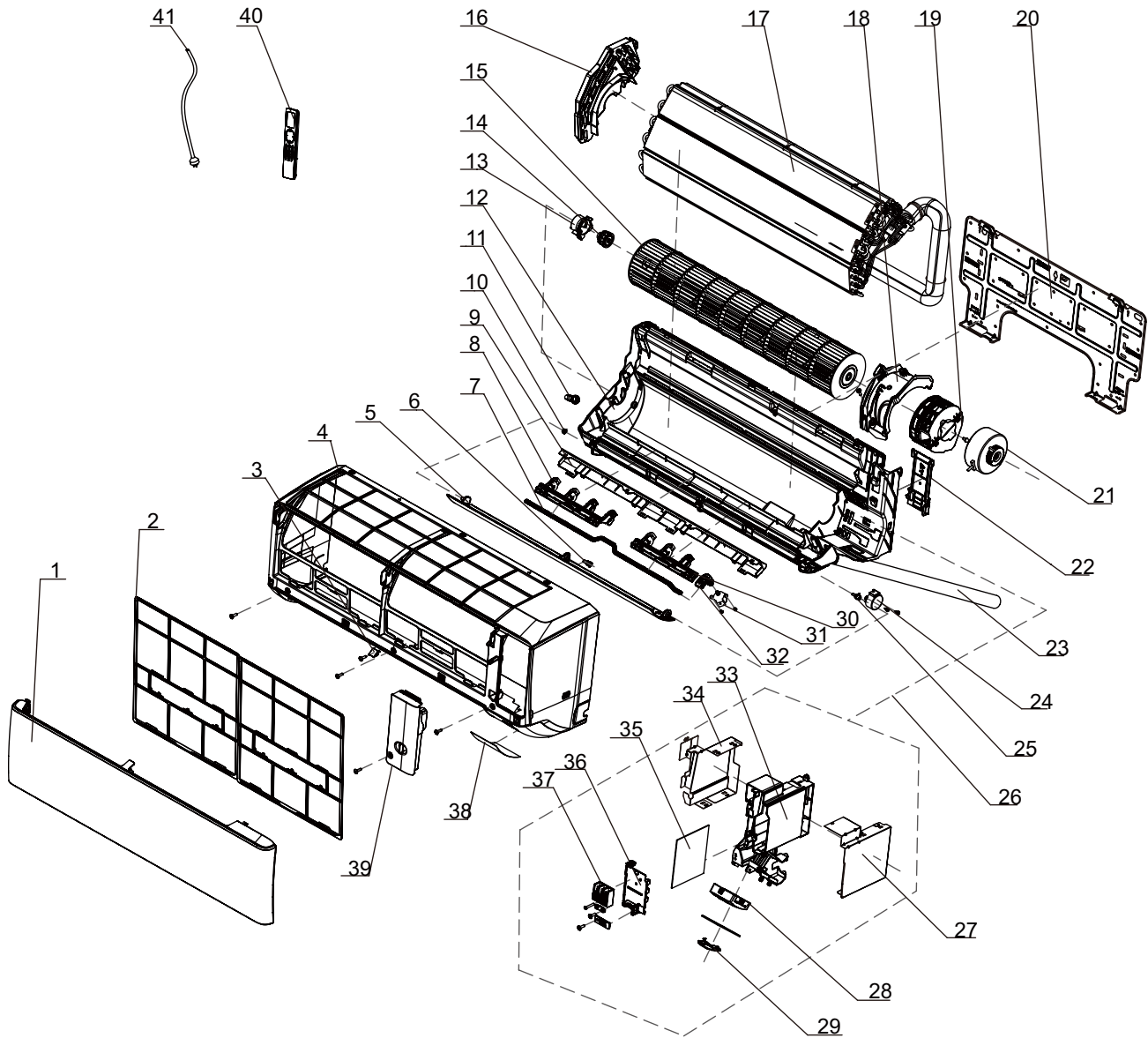

The component picture is only for reference; please refer to the actual product.

NO.	Description
1	Front Panel
2	Filter Sub-Assy
3	Screw Cover
4	Front Case
5	Guide Louver
6	Axile Bush
7	Swing Lever
8	Air Louver (left)
9	Helicoid Tongue
10	Left Axile Bush
11	Rubber Plug (Water Tray)
12	Rear Case
13	Ring of Bearing
14	O-Gasket of Cross Fan Bearing
15	Cross Flow Fan
16	Evaporator Support
17	Evaporator Assy
18	Motor Press Plate
19	Motor Cover
20	Wall Mounting Frame
21	Brushless DC Motor
22	Connecting pipe clamp
23	Drainage Pipe Sub-assy
24	Stepping Motor
25	Crank
26	Electric Box Assy
27	Electric Box Fireproofing Cover 2
28	Display Board Cover
29	Indicator Shield Cover
30	Air Louver(right)
31	Stepping Motor
32	Air Louver
33	Electric Box
34	Electric Box Fireproofing Cover 1
35	Main Board
36	Supporter(Electric Box)
37	Terminal Board
38	Membrane(display window)
39	Electric Box Cover
40	Remote Controller
41	Power Cord

Some models may not contain some parts, please refer to the actual product.

10.2 Outdoor Unit

GWH09APAXE-K6DNA3A/O GWH12APAXE-K6DNA3A/O

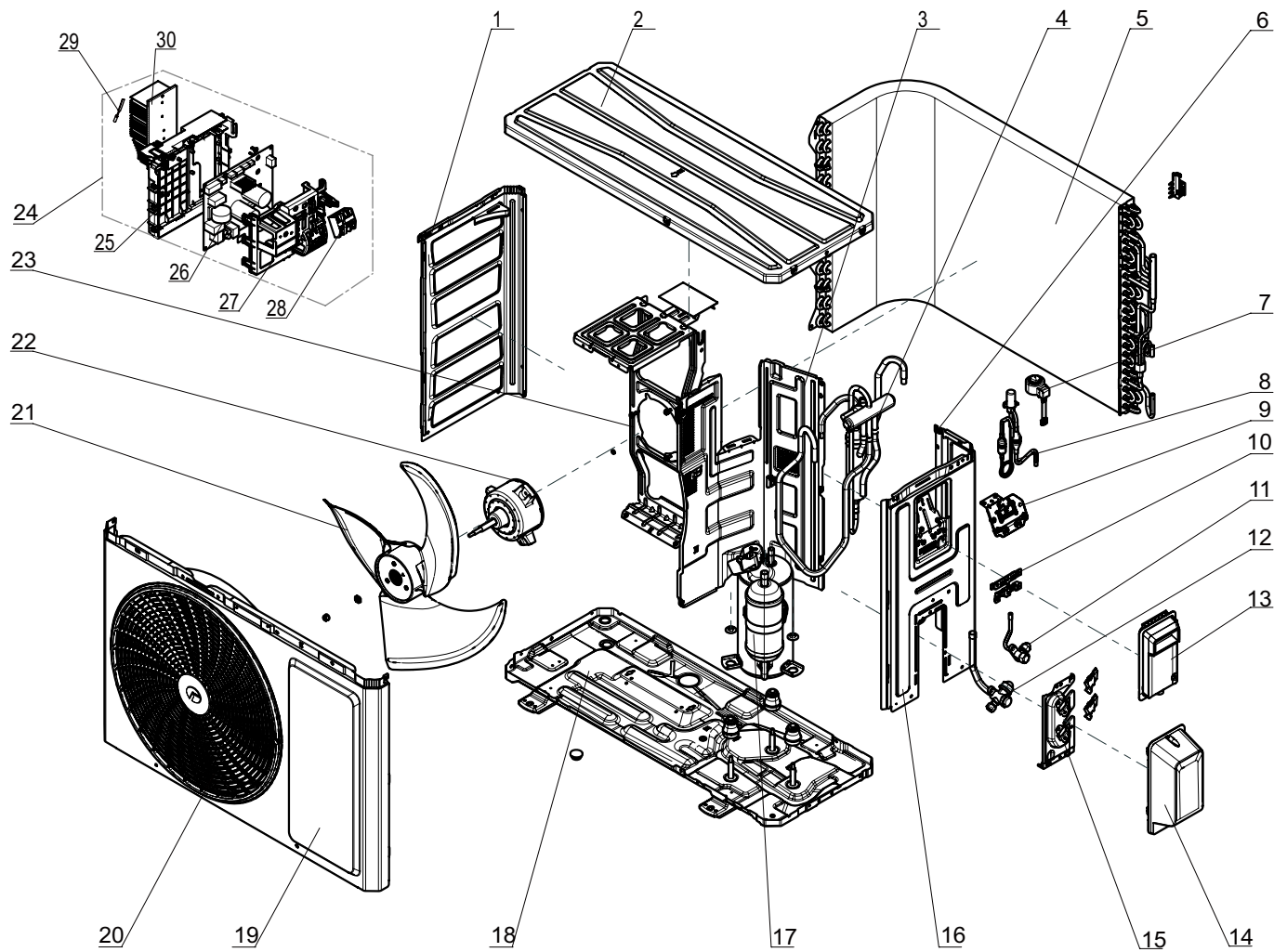

The component is only for reference; please refer to the actual product

NO.	Description
1	Left Side Plate
2	Top Cover Assy
3	Clapboard Assy
4	4-Way Valve
5	Condenser Assy
6	Temperature Sensor clamp
7	Electric Expand Valve Fitting
8	Electric Expansion Valve Sub-Assy
9	Earthing Plate Sub-assy
10	Wire Clamp
11	Cut-off valve(gas)
12	Cut-off valve(liquid)
13	Handle
14	Valve Cover
15	Valve Support
16	Right Side Plate
17	Compressor and Fittings
18	Chassis Sub-assy
19	Cabinet
20	Front Grill
21	Axial Flow Fan
22	Brushless DC Motor
23	Motor Support
24	Electric Box Assy
25	Electric Box
26	Main Board
27	Electric Box Cover
28	Terminal Board
29	Temperature Sensor
30	Radiator

Some models may not contain some parts, please refer to the actual product.

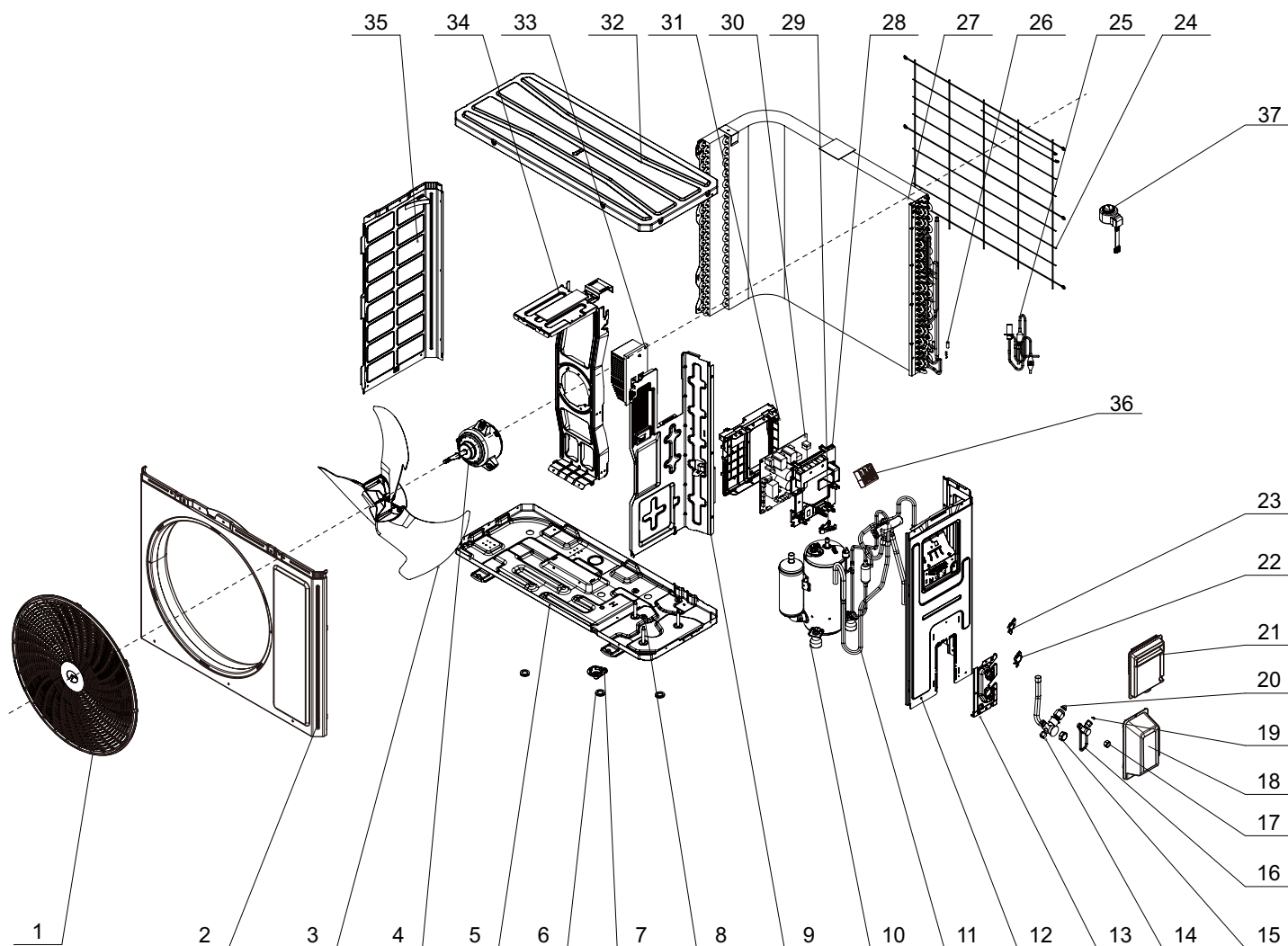

The component is only for reference; please refer to the actual product

NO.	Description
1	Front Grill
2	Cabinet
3	Axial Flow Fan
4	Brushless DC Motor
5	Chassis Sub-assy
6	Drainage Plug
7	Drainage Connector
8	Cushioned Nut
9	Clap Board Assy
10	Compressor and fittings
11	4-way Valve Assy
12	Right Side Plate Assy
13	Valve Support Sub
14	Cut-off Valve(gas)
15	Back Cover Nut
16	Cut-off Valve(liquid)
17	Back Cover Nut
18	Valve Cover
19	Union Nut
20	Union Nut
21	Handle
22	Support
23	Valve Support Baffle
24	Rear Grill
25	Electronic Expansion Valve assy
26	Temperature Sensor
27	Condenser Assy
28	Electric Box Cover
29	Pipe Clamp
30	Main Board
31	Electric box
32	Top Cover-assy
33	Motherboard radiator
34	Motor Support Sub-Assy
35	Left Side Plate
36	Terminal Board
37	Electric Expand Valve Fitting

Some models may not contain some parts, please refer to the actual product.

11. Removal Procedure

11.1 Removal Procedure of Indoor Unit

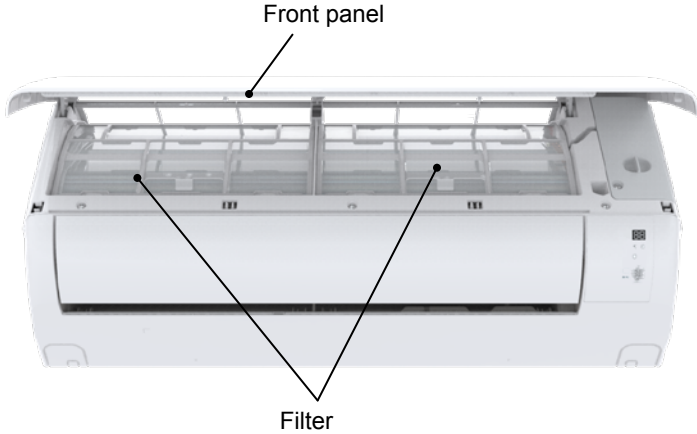
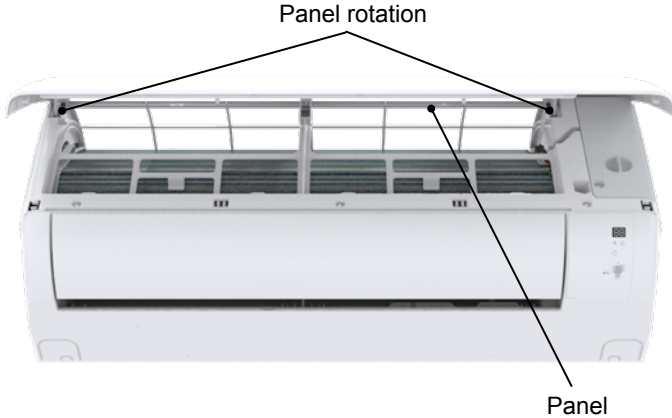

Caution: discharge the refrigerant completely before removal.

Step	Procedure
Before disassemble	<p>Turn off the air conditioner and disconnect the power before disassemble the air conditioner.</p> 
1. Remove filter	<p>Open the front panel; Push the filter upwards to loosen the clasp and then pull the left filter and right filter outwards to remove them.</p> 
2. Remove front panel	<p>Separate the panel rotation shaft from the groove fixing the front panel and then removes the front panel.</p> <p>Note: The display of some models is fixed on the panel; unscrew the screws fixing the display on the panel before removing the panel.</p> 

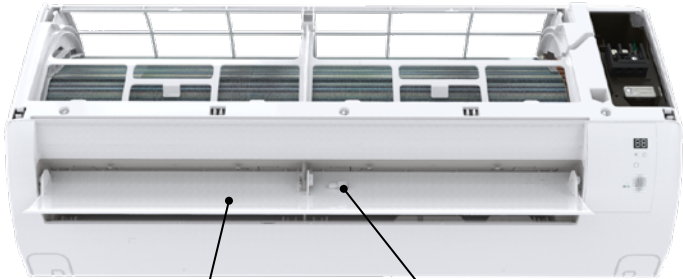
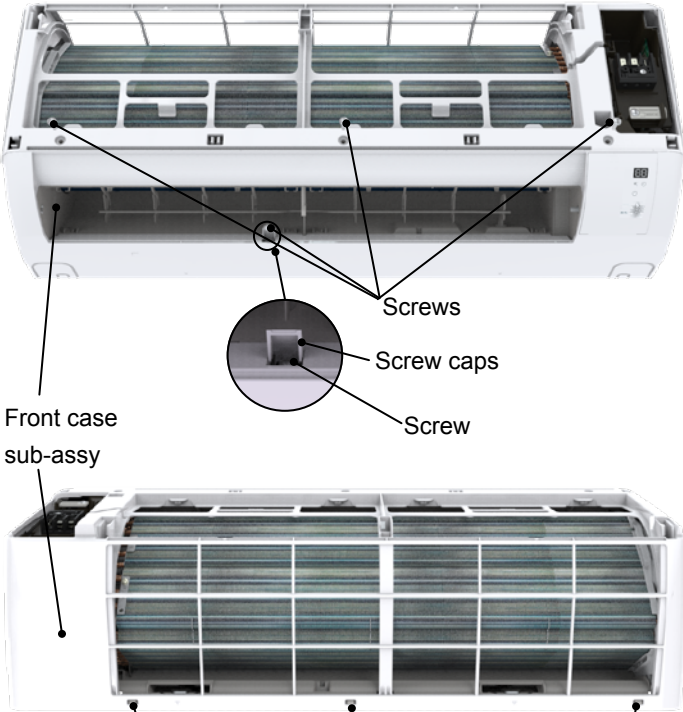
Step	Procedure	Procedure
3.Remove electric box cover sub-assy2 and detecting plate(wifi)	Remove the screws on the electric box cover sub-assy2 and detecting plate(WIFI), to remove the electric box cover 2 and detecting plate(WIFI).	 <p>Electric box cover sub-assy2</p>
4.Remove horizontal louver	Push out the axle bush on horizontal louver. Bend the horizontal louver with hand and then separate the horizontal louver from the crankshaft of step motor to remove it.	 <p>Horizontal louver</p> <p>Axile bush</p>
5.Remove front case sub-assy	<p>a Remove the screws fixing front case.</p> <p>Note:</p> <p>(1) Open the screw caps before removing the screws around the air outlet.</p> <p>(2) The quantity of screws fixing the front case sub-assy is different for different models.</p> <p>b Loosen the clasps at left, middle and right sides of front case. Lift the front case sub-assy upwards to remove it.</p>	 <p>Front case sub-assy</p> <p>Screws</p> <p>Screw caps</p> <p>Screw</p> <p>Left clasp</p> <p>Middle clasp</p> <p>Right clasp</p>

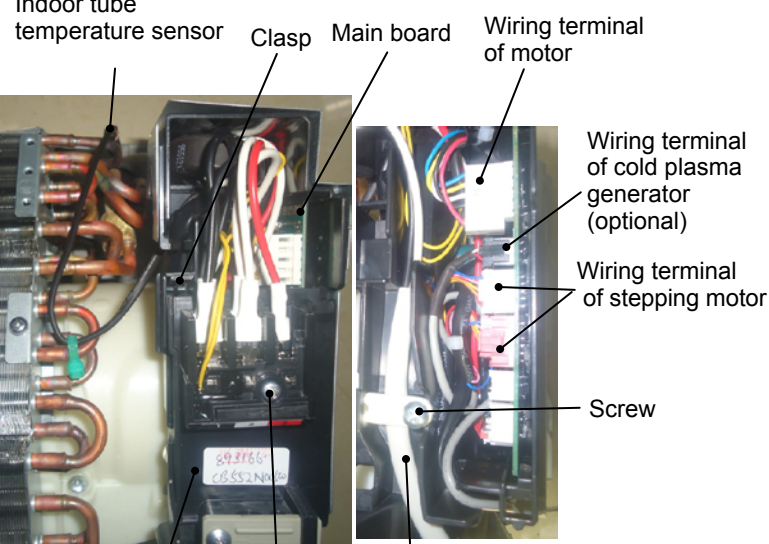
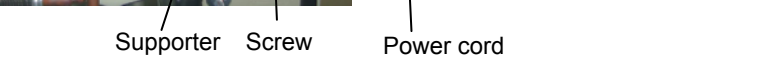
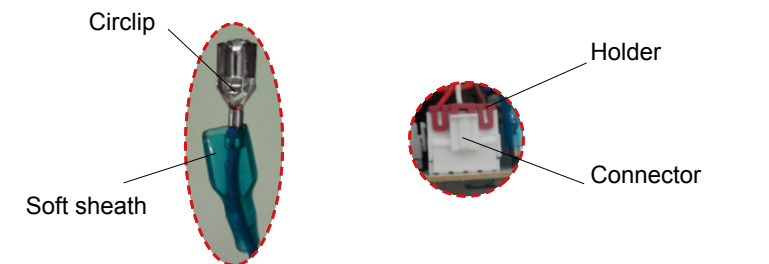
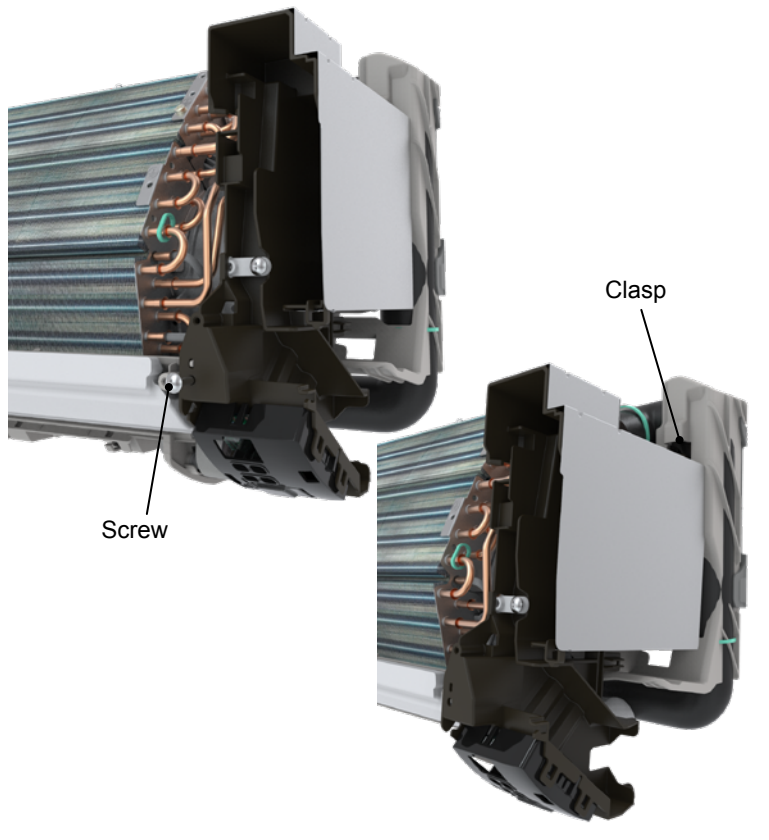
Step	Procedure
6.Remove electric box cover sub-assy	
a	<p>Remove the screw fixing terminal board, remove the terminal board.</p> 
b	<p>loosen the clasps and remove the supporter.</p> 
c	<p>① Cut off the wire binder and pull out the indoor tube temperature sensor. ② Screw off one grounding screw.(optional) ③ Remove the wiring terminals of motor, cold plasma generator and stepping motor. ④ Remove the screw fixing wire clamp, Loosen power cord.</p> <p>Instruction:Some wiring terminal of this products is with lock catch and other devices.The pulling method is as below:</p> <p>1.Remove the soft sheath for some terminals at first, hold the circlip and then pull out the terminals, 2.Pull out the holder for some terminals at first(holder is not available for some wiring terminal).hold the connector and then pull the terminal.</p> 
d	<p>Remove the screw fixing electric box, lift up, then pull back so that the clasps above the electrical box are removed and the electrical box can be removed.</p> 

Step	Procedure
8.Remove motor	
a	Loosen the screws (4-5 circles) used for fixing the cross flow fan.
b	Use a screwdriver or other tools to pry the bottom case downwards at the position as shown in the figure to make the upper space-limiting rib on the bottom case not to bear against the motor cover; lift the motor box upwards along the arrow direction to let the clasp come out, and pull the motor box to the right and then the motor box and motor can be removed.
c	Loosen the two clasps and open the motor cover to remove the motor
9.Remove evaporator assy	
a	Remove 2 screws fixing evaporator assy.

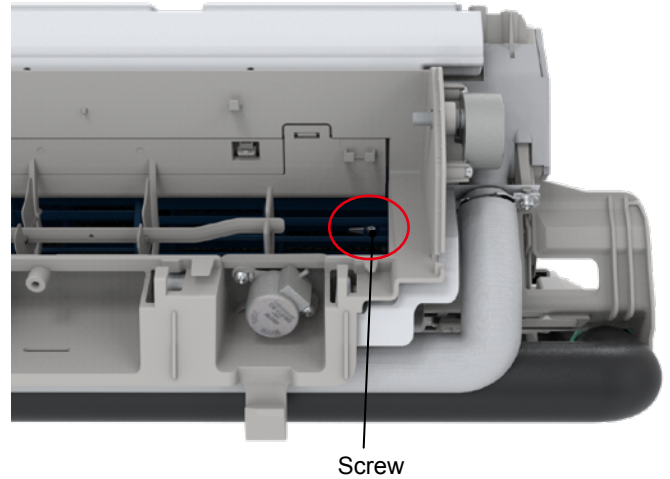

Screw

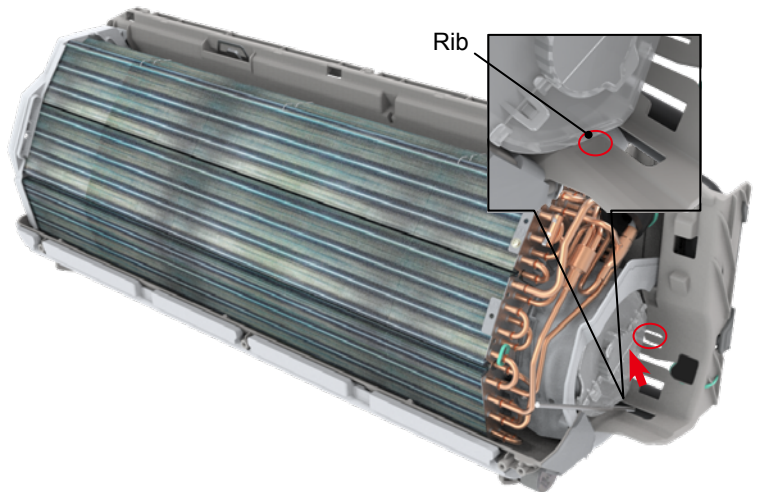

Rib

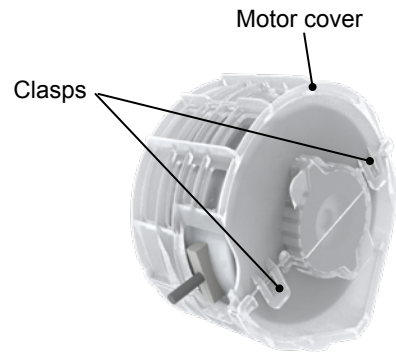

Motor cover

Clasps

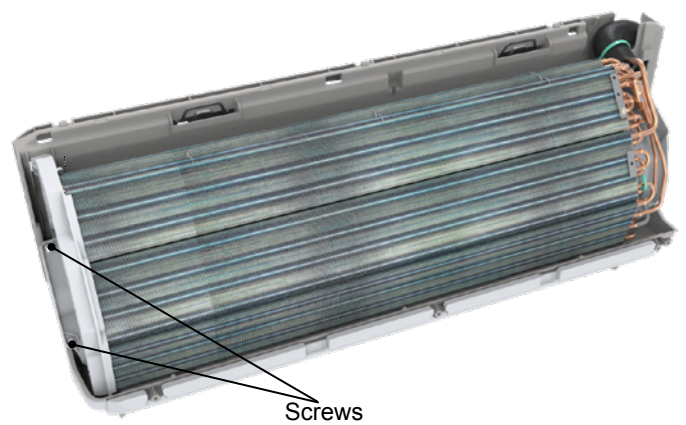

Screws

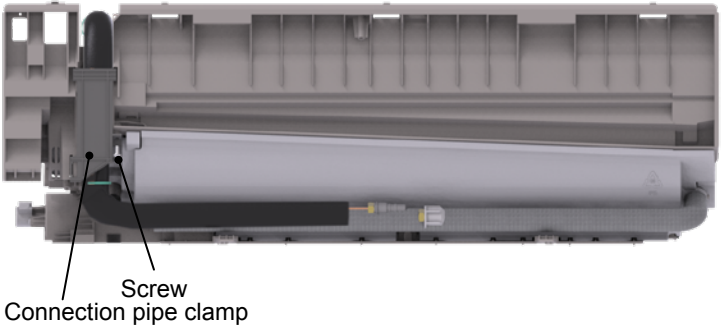
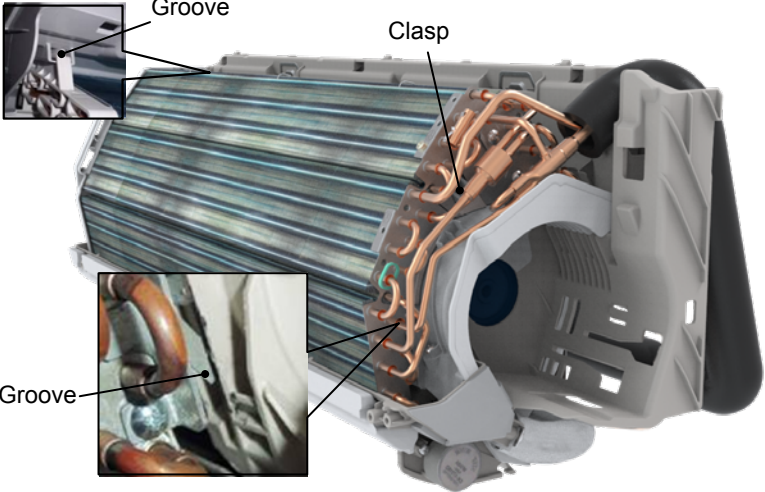
Step	Procedure
b	<p>At the back of the unit, remove the screw of the connection pipe clamp and then remove the connection pipe clamp.</p>  <p>The diagram shows the rear view of the unit's internal components. A screw is shown securing a connection pipe clamp to the back of the evaporator coil. Labels point to the 'Screw' and the 'Connection pipe clamp'.</p>
c	<p>First remove the left side of evaporator from the groove of bottom shell and then remove the right side from the clasp on the bottom shell. Lift the evaporator upwards to remove it.</p>  <p>The diagram shows the evaporator coil being lifted out of the bottom shell. Two inset images provide close-up views: one shows the coil being detached from a 'Groove' on the left side, and the other shows it being detached from a 'Clasp' on the right side. Labels identify the 'Groove', 'Clasp', and another 'Groove'.</p>



11.2 Removal Procedure of Outdoor Unit

GWH09APAXE-K6DNA3A/O GWH12APAXE-K6DNA3A/O

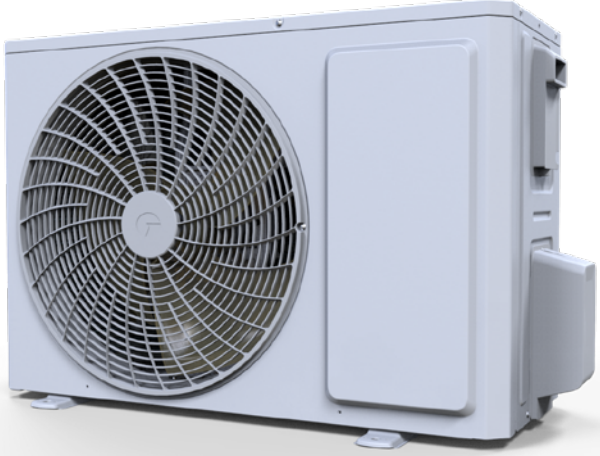
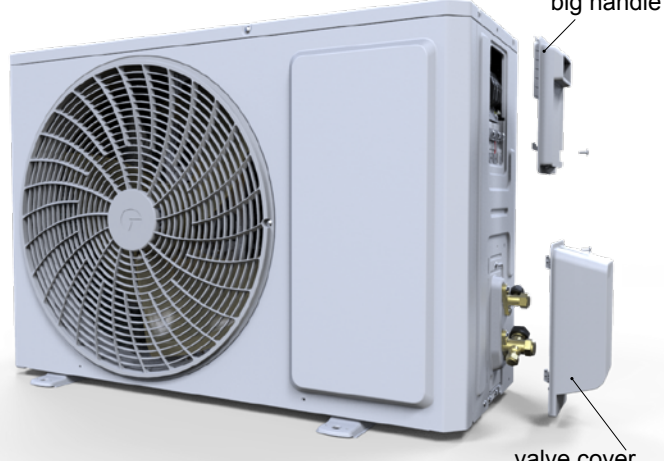
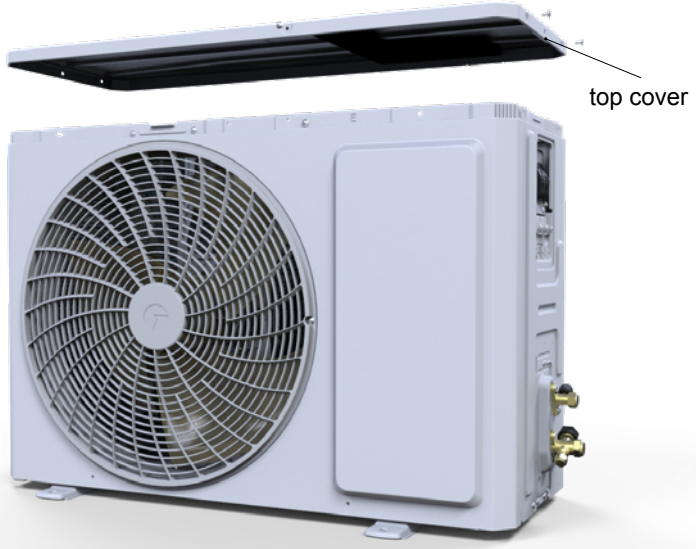

Caution: discharge the refrigerant completely before removal.

Step	Procedure
1. Before disassembly	
2. Remove big handle	<p>Remove the screws fixing big handle and then remove them.</p> 
3. Remove top cover	<p>Remove the screws fixing top cover and then remove the top cover.</p> 

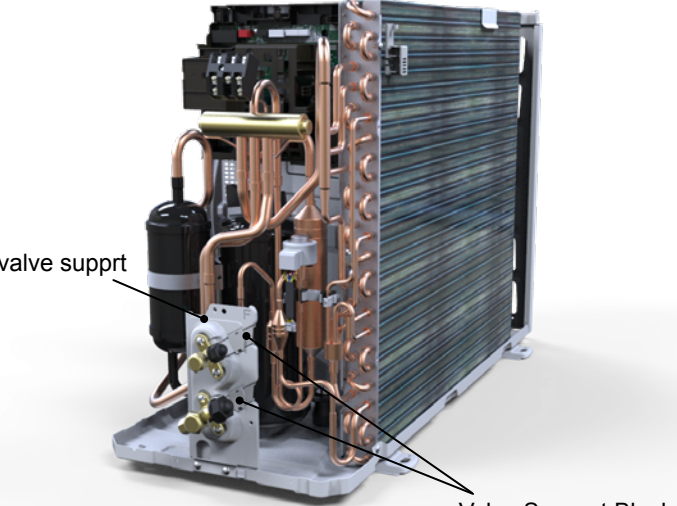
Step	Procedure
<p>4. Remove front panel assy</p>	<p>Remove connection screws connecting the front panel assy with the chassis and the motor support, and then remove the front panel assy.</p>  <p>Front Panel Assy</p>
<p>5. Remove right side plate assy</p>	<p>Rescrew the ground screws, remove the ground wires, loosen the screws fixing terminal board, remove the terminal board, rescrew the screws fixing the right plate, and remove the right side plate assy.</p>  <p>Right Side Plate Assy</p>
<p>6. Remove valve support</p>	<p>Remove the valve support block, remove the screws fixing valve support, remove the screws fixing the liquid valve and gas valve then remove the valve support.</p>  <p>valve supprt</p> <p>Valve Support Block</p>

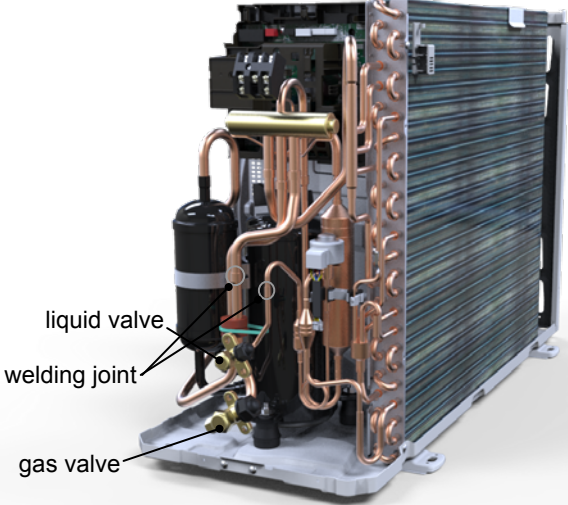
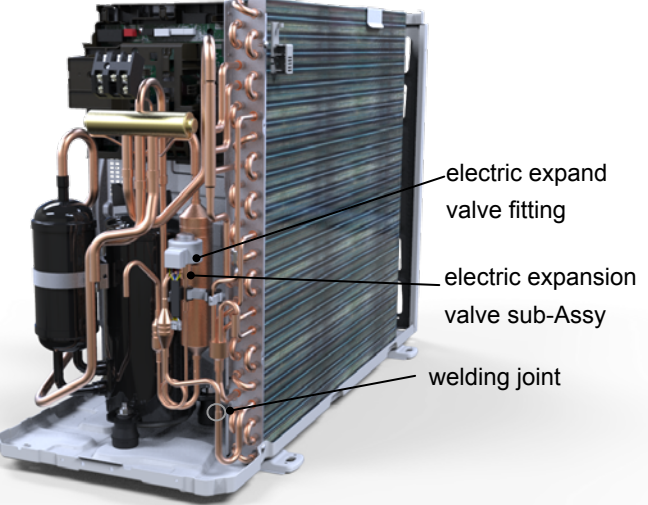
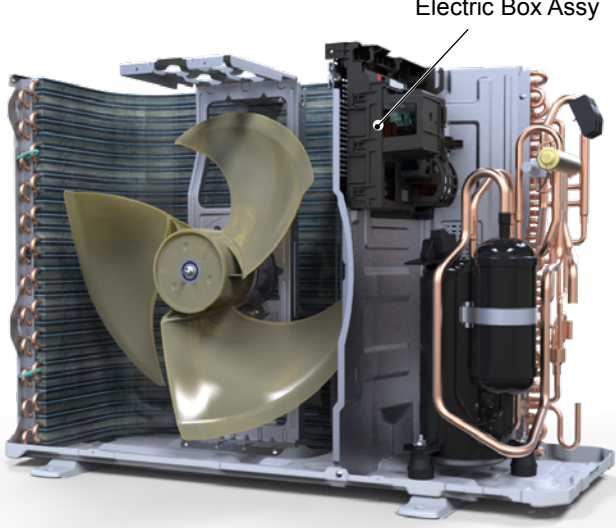

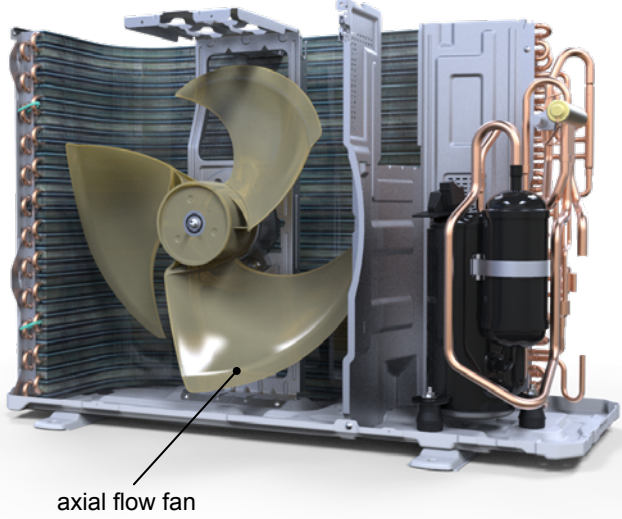
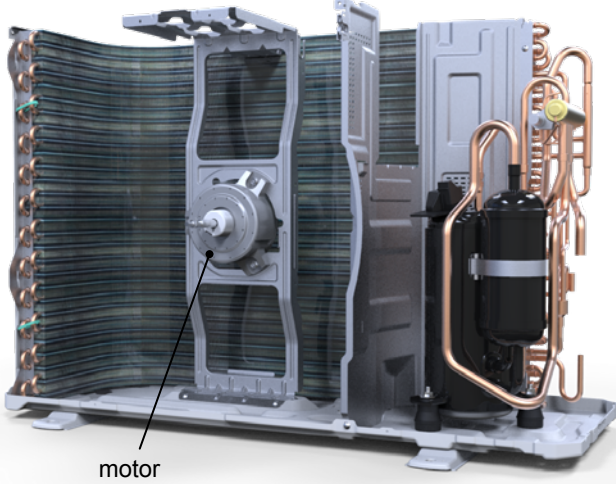
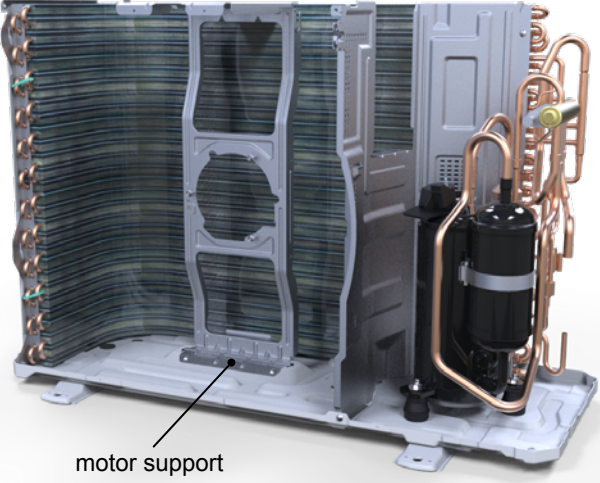
Step	Procedure
<p>7. Remove gas valve and liquid valve</p> <p>Unsolder the welding joint connecting the gas valve and the liquid valve, remove them.</p> <p>Note: Discharge the refrigerant completely before unsoldering; when unsoldering, wrap the gas valve with a wet cloth completely to avoid damage to the valve caused by high temperature.</p>	 <p>liquid valve</p> <p>welding joint</p> <p>gas valve</p>
<p>8. Remove electronic expansion valve</p> <p>Remove the terminals of the electric expand valve fitting and rotate to remove the electric expand valve fitting.</p> <p>Unsolder the welding joint connecting the electronic expansion Valve and then remove the electronic expansion valve.</p>	 <p>electric expand valve fitting</p> <p>electric expansion valve sub-Assembly</p> <p>welding joint</p>
<p>9. Remove electric box assy</p> <p>Unplug the terminals, unscrew 1 screw that secures the electrical box assy, release the two snaps on the electrical box assy (in the clapboard and condenser angle), pull outwards, and remove the electrical box assy.</p>	 <p>Electric Box Assy</p>

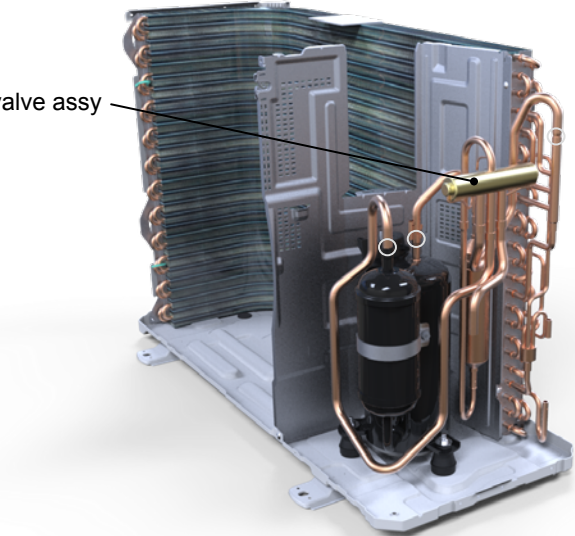
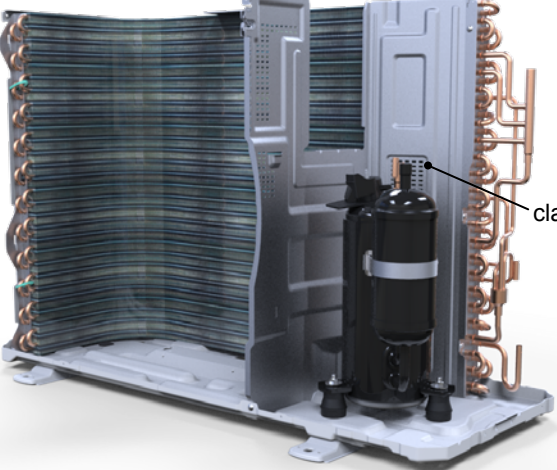
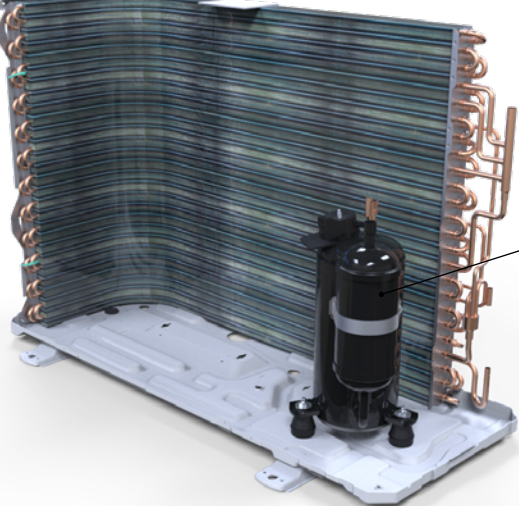

Step	Procedure
<p>10. Remove axial flow fan</p> <p>Remove the nut on the fan and then remove the axial flow fan.</p>	 <p>axial flow fan</p>
<p>11. Remove motor</p> <p>Remove the screws fixing the motor and then remove the motor.</p>	 <p>motor</p>
<p>12. Remove motor support</p> <p>Remove the screws fixing the motor support and lift the motor support to remove it.</p>	 <p>motor support</p>

Step	Procedure
<p>13. Remove 4-way valve assy</p>	<p>Unsolder the welding joints connecting the 4-way valve assy, remove the 4-way valve.</p> <p>Note: Before unsoldering the welding joint, wrap the 4-way valve with a wet cloth completely to avoid damage to the valve caused by high temperature.</p> 
<p>14. Remove clapboard assy</p>	<p>Remove the screws fixing the clapboard assy and then remove the clapboard assy.</p> 
<p>15. Remove compressor</p>	<p>Remove the 3 foot nuts on the compressor and then remove the compressor.</p> 



Caution: discharge the refrigerant completely before removal.

Step	Procedure
<p>1. Before disassembly</p>	
<p>2. Remove top cover</p>	<p>Remove the screws fixing top cover and then remove the top cover.</p> 
<p>3. Remove big handle and valve cover</p>	<p>Remove the screws fixing big handle, valve cover and then remove them.</p> 

Step	Procedure
<p>4. Remove front panel assy</p>	<p>Remove connection screws connecting the front panel assy with the chassis and the motor support, and then remove the front panel assy.</p> 
<p>5. Remove rear grill</p>	<p>Remove the screws connecting the left side plate and right side plate and then remove rear grill.</p> 
<p>6. Remove right side plate assy</p>	<p>Rescrew the ground screws, remove the ground wires, loosen the screws fixing terminal board, remove the terminal board, rescrew the screws fixing the right plate, and remove the right side plate assy.</p> 

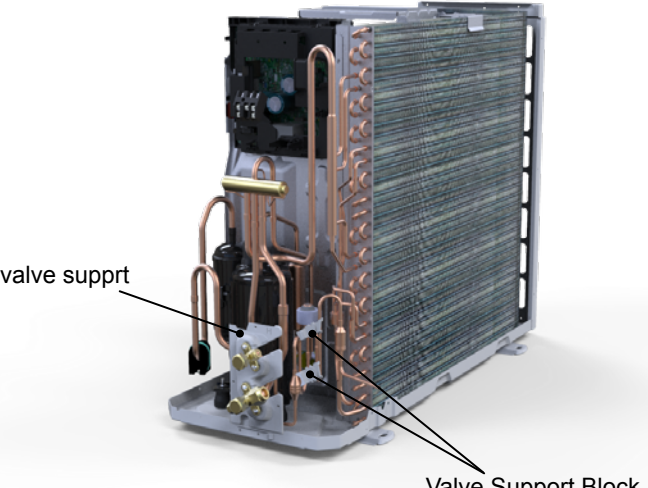
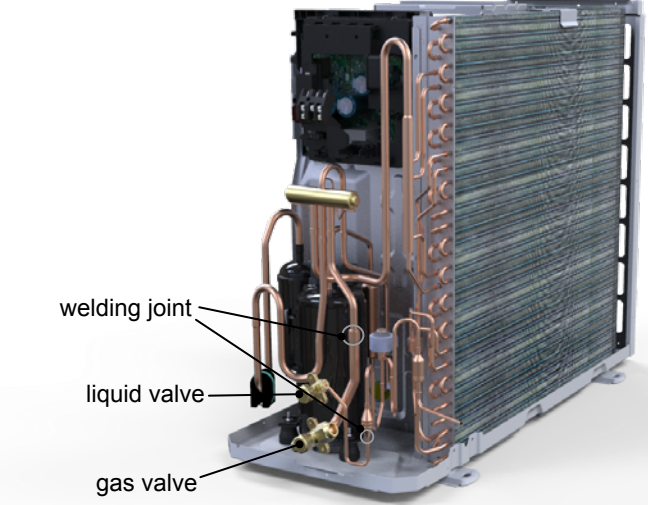
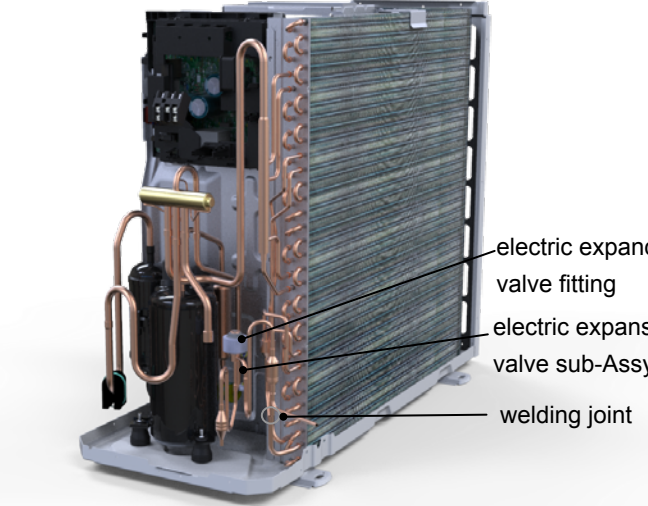
Step	Procedure
<p>7. Remove valve support</p>	<p>Remove the valve support block, remove the screws fixing valve support, remove the screws fixing the liquid valve and gas valve then remove the valve support.</p> 
<p>8. Remove gas valve and liquid valve</p>	<p>Unsolder the welding joint connecting the gas valve and the liquid valve, remove them.</p> <p>Note: Discharge the refrigerant completely before unsoldering; when unsoldering, wrap the gas valve with a wet cloth completely to avoid damage to the valve caused by high temperature.</p> 
<p>9. Remove electronic expansion valve</p>	<p>Remove the terminals of the electric expand valve fitting and rotate to remove the electric expand valve fitting.</p> <p>Unsolder the welding joint connecting the electronic expansion Valve and then remove the electronic expansion valve.</p> 

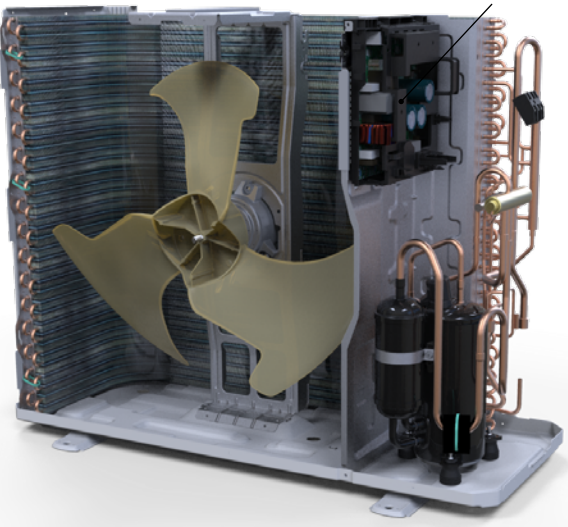
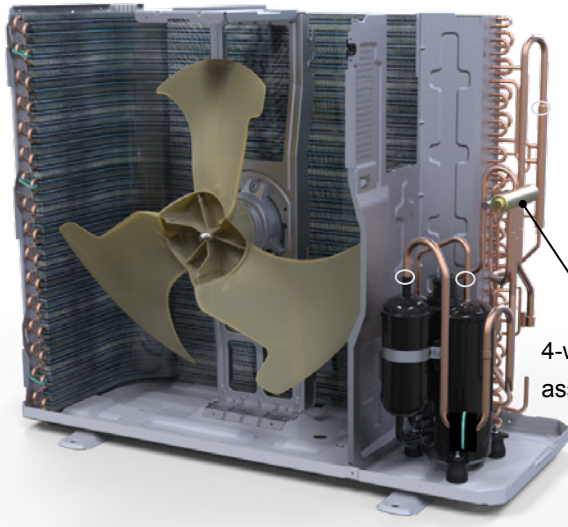
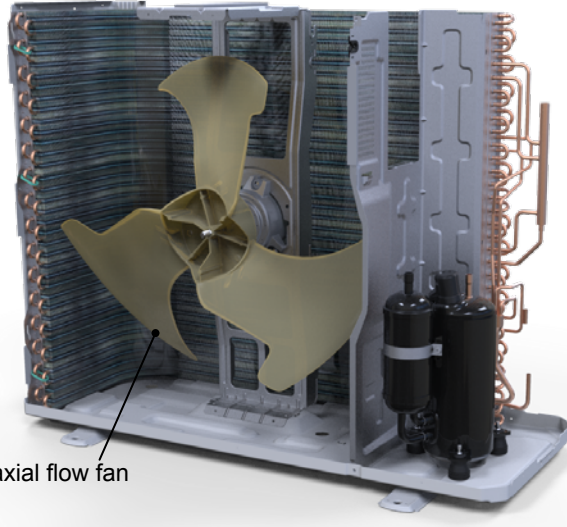
Step	Procedure
<p>10. Remove electric box assy</p>	<p>Unplug the terminals, unscrew 1 screw that secures the electrical box assy, release the two snaps on the electrical box assy (in the clapboard and condenser angle), pull outwards, and remove the electrical box assy.</p> 
<p>11. Remove 4-way valve assy</p>	<p>Unsolder the welding joints connecting the 4-way valve assy, remove the 4-way valve.</p> <p>Note: Before unsoldering the welding joint, wrap the 4-way valve with a wet cloth completely to avoid damage to the valve caused by high temperature.</p> 
<p>12. Remove axial flow fan</p>	<p>Remove the nut on the fan and then remove the axial flow fan.</p> 

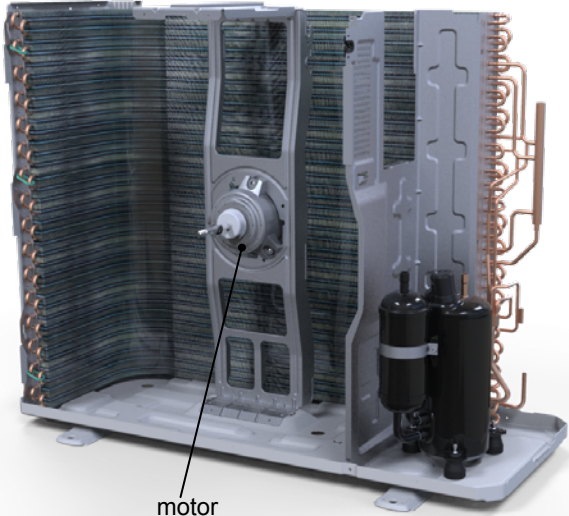
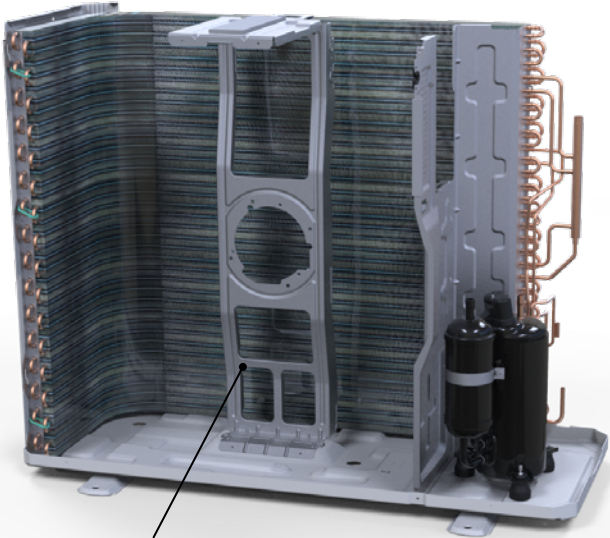
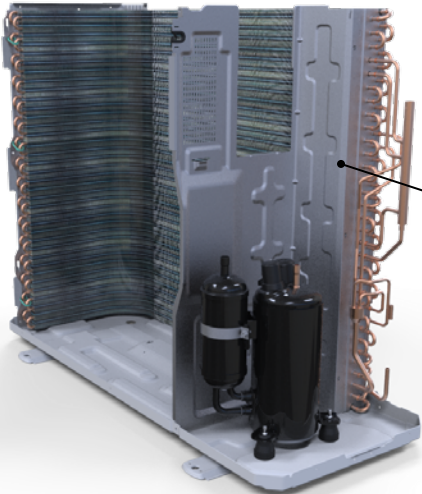
Step	Procedure
<p>13. Remove motor</p>	<p>Remove the screws fixing the motor and then remove the motor.</p> 
<p>14. Remove motor support</p>	<p>Remove the screws fixing the motor support and lift the motor support to remove it.</p> 
<p>15. Remove clapboard assy</p>	<p>Remove the screws fixing the clapboard assy and then remove the clapboard assy.</p> 

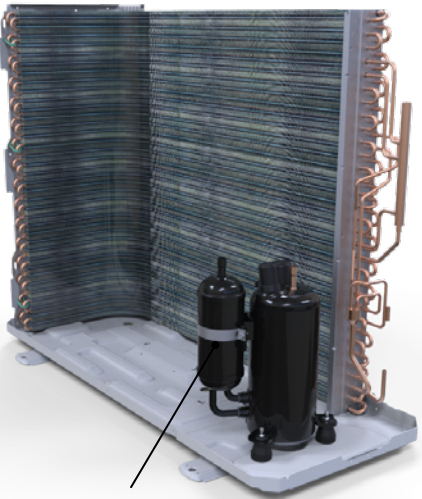
Step	Procedure
16. Remove compressor	<p data-bbox="191 497 789 570">Remove the 3 foot nuts on the compressor and then remove the compressor.</p>  <p data-bbox="1019 744 1149 770">compressor</p>

Appendix

Appendix 1: Reference Sheet of Celsius and Fahrenheit

Conversion formula for Fahrenheit degree and Celsius degree: $T_f = T_c \times 1.8 + 32$

Set temperature

Fahrenheit display temperature (°F)	Fahrenheit (°F)	Celsius (°C)	Fahrenheit display temperature (°F)	Fahrenheit (°F)	Celsius (°C)	Fahrenheit display temperature (°F)	Fahrenheit (°F)	Celsius (°C)
61	60.8	16	69/70	69.8	21	78/79	78.8	26
62/63	62.6	17	71/72	71.6	22	80/81	80.6	27
64/65	64.4	18	73/74	73.4	23	82/83	82.4	28
66/67	66.2	19	75/76	75.2	24	84/85	84.2	29
68	68	20	77	77	25	86	86	30

Ambient temperature

Fahrenheit display temperature (°F)	Fahrenheit (°F)	Celsius (°C)	Fahrenheit display temperature (°F)	Fahrenheit (°F)	Celsius (°C)	Fahrenheit display temperature (°F)	Fahrenheit (°F)	Celsius (°C)
32/33	32	0	55/56	55.4	13	79/80	78.8	26
34/35	33.8	1	57/58	57.2	14	81	80.6	27
36	35.6	2	59/60	59	15	82/83	82.4	28
37/38	37.4	3	61/62	60.8	16	84/85	84.2	29
39/40	39.2	4	63	62.6	17	86/87	86	30
41/42	41	5	64/65	64.4	18	88/89	87.8	31
43/44	42.8	6	66/67	66.2	19	90	89.6	32
45	44.6	7	68/69	68	20	91/92	91.4	33
46/47	46.4	8	70/71	69.8	21	93/94	93.2	34
48/49	48.2	9	72	71.6	22	95/96	95	35
50/51	50	10	73/74	73.4	23	97/98	96.8	36
52/53	51.8	11	75/76	75.2	24	99	98.6	37
54	53.6	12	77/78	77	25			

Appendix 2: Configuration of Connection Pipe

- Standard length of connection pipe (More details please refer to the specifications.)
- Min. length of connection pipe is 3m.
- Max. length of connection pipe and max. high difference. (More details please refer to the specifications.)
- The additional refrigerant oil and refrigerant charging required after prolonging connection pipe
 - After the length of connection pipe is prolonged for 10m at the basis of standard length, you should add 5ml of refrigerant oil for each additional 5m of connection pipe.
 - The calculation method of additional refrigerant charging amount (on the basis of liquid pipe):
 - Basing on the length of standard pipe, add refrigerant according to the requirement as shown in the table. The additional refrigerant charging amount per meter is different according to the diameter of liquid pipe. See the following sheet.

Additional refrigerant charging amount for R32

Piping size		Indoor unit throttle	Outdoor unit throttle	
Liquid pipe	Gas pipe	Cooling only, cooling and heating (g / m)	Cooling only(g/m)	Cooling and heating(g/m)
1/4"	3/8" or 1/2"	14	12	16
1/4" or 3/8"	5/8" or 3/4"	40	12	40
1/2"	3/4" or 7/8"	80	24	96
5/8"	1" or 1 1/4"	136	48	96
3/4"	/	200	200	200
7/8"	/	280	280	280

Appendix 3: Pipe Expanding Method

Note:

Improper pipe expanding is the main cause of refrigerant leakage. Please expand the pipe according to the following steps:

A: Cut the pipe

- Confirm the pipe length according to the distance of indoor unit and outdoor unit.
- Cut the required pipe with pipe cutter.

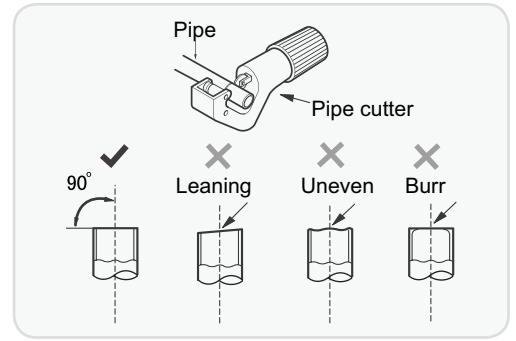

B: Remove the burrs

- Remove the burrs with shaper and prevent the burrs from getting into the pipe.

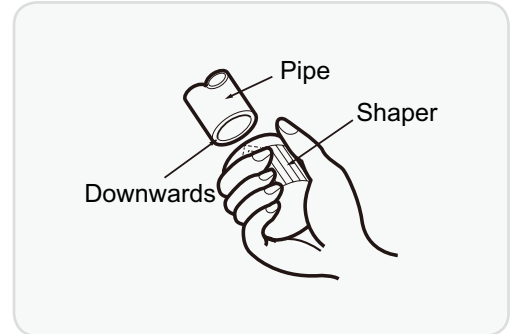

C: Put on suitable insulating pipe.

D: Put on the union nut

- Remove the union nut on the indoor connection pipe and outdoor valve; install the union nut on the pipe.

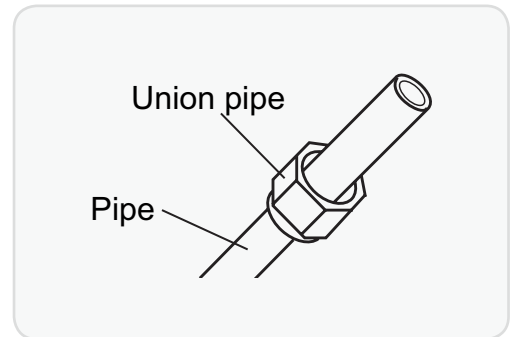

E: Expand the port

- Expand the port with expander.

Note:

- "A" is different according to the diameter, please refer to the sheet below:

Outer diameter(mm)	A(mm)	
	Max	Min
Φ6 - 6.35 (1/4")	1.3	0.7
Φ9 - Φ9.52 (3/8")	1.6	1.0
Φ12 - 12.70 (1/2")	1.8	1.0
Φ16 - 15.88 (5/8")	2.4	2.2

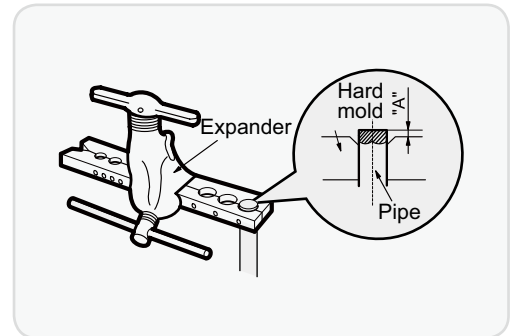

F: Inspection

- Check the quality of expanding port. If there is any blemish, expand the port again according to the steps above.

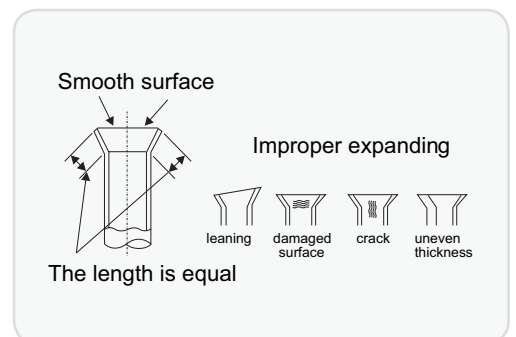

Appendix 4: List of Resistance for Temperature Sensor

Resistance Table of Ambient Temperature Sensor for Indoor and Outdoor Units(15K)

Temp(°C)	Resistance(kΩ)	Temp(°C)	Resistance(kΩ)	Temp(°C)	Resistance(kΩ)	Temp(°C)	Resistance(kΩ)
-19	138.10	0	49.02	20	18.75	40	7.97
-18	128.60	2	44.31	22	17.14	42	7.35
-16	115.00	4	40.09	24	15.68	44	6.79
-14	102.90	6	36.32	26	14.36	46	6.28
-12	92.22	8	32.94	28	13.16	48	5.81
-10	82.75	10	29.90	30	12.07	50	5.38
-8	74.35	12	27.18	32	11.09	52	4.99
-6	66.88	14	24.73	34	10.20	54	4.63
-4	60.23	16	22.53	36	9.38	56	4.29
-2	54.31	18	20.54	38	8.64	58	3.99

Resistance Table of Tube Temperature Sensors for Indoor and Outdoor (20K)

Temp(°C)	Resistance(kΩ)	Temp(°C)	Resistance(kΩ)	Temp(°C)	Resistance(kΩ)	Temp(°C)	Resistance(kΩ)
-19	181.40	20	25.01	60	4.95	100	1.35
-15	145.00	25	20.00	65	4.14	105	1.16
-10	110.30	30	16.10	70	3.48	110	1.01
-5	84.61	35	13.04	75	2.94	115	0.88
0	65.37	40	10.62	80	2.50	120	0.77
5	50.87	45	8.71	85	2.13	125	0.67
10	39.87	50	7.17	90	1.82	130	0.59
15	31.47	55	5.94	95	1.56	135	0.52

Resistance Table of Discharge Temperature Sensor for Outdoor(50K)

Temp(°C)	Resistance(kΩ)	Temp(°C)	Resistance(kΩ)	Temp(°C)	Resistance(kΩ)	Temp(°C)	Resistance(kΩ)
-30	911.400	10	98	50	17.65	90	4.469
-25	660.8	15	77.35	55	14.62	95	3.841
-20	486.5	20	61.48	60	12.17	100	3.315
-15	362.9	25	49.19	65	10.18	105	2.872
-10	274	30	39.61	70	8.555	110	2.498
-5	209	35	32.09	75	7.224	115	2.182
0	161	40	26.15	80	6.129	120	1.912
5	125.1	45	21.43	85	5.222	125	1.682



JF00305302



GREE ELECTRIC APPLIANCES, INC. OF ZHUHAI

Add: West Jinji Rd, Qianshan, Zhuhai, Guangdong, China, 519070

Tel: (+86-756) 8522219

Fax: (+86-756) 8669426

E-mail: global@cn.gree.com

For product improvement, specifications and appearance in this manual are subject to change without prior notice.