



# Service Manual

**GREE ELECTRIC APPLIANCES, INC. OF ZHUHAI**



# Table of Contents

<b>Part I : Technical Information</b> .....	<b>1</b>
<b>1. Summary</b> .....	<b>1</b>
<b>2. Specifications</b> .....	<b>3</b>
2.1 Specification Sheet.....	3
2.2 Capacity Variation Ratio According to Temperature .....	11
2.3 Cooling and Heating Data Sheet in Rated Frequency.....	11
<b>3. Outline Dimension Diagram</b> .....	<b>12</b>
3.1 Indoor Unit.....	12
3.2 Outdoor Unit.....	13
<b>4. Refrigerant System Diagram</b> .....	<b>15</b>
<b>5. Electrical Part</b> .....	<b>16</b>
5.1 Wiring Diagram .....	16
5.2 PCB Printed Diagram .....	19
<b>6. Function and Control</b> .....	<b>23</b>
6.1 Remote Controller Introduction for YBE1FB9 .....	23
6.2 Remote Controller Introduction for YBE1FB12 .....	29
6.3 Brief Description of Models and Functions .....	35
6.4 GREE+ App Operation Manual .....	41
6.5 Ewpe Smart App Operation Manual.....	42
<b>Part II : Installation and Maintenance</b> .....	<b>43</b>
<b>7. Notes for Installation and Maintenance</b> .....	<b>43</b>
<b>8. Installation</b> .....	<b>52</b>
8.1 Installation Dimension Diagram.....	52
8.2 Installation Parts-checking .....	54
8.3 Selection of Installation Location.....	54
8.4 Electric Connection Requirement.....	54

8.5 Installation of Indoor Unit.....	55
8.6 Installation of Outdoor Unit.....	57
8.7 Vacuum Pumping and Leak Detection.....	58
8.8 Check after Installation and Test Operation.....	59
<b>9. Maintenance.....</b>	<b>60</b>
9.1 Error Code List.....	60
9.2 Procedure of Troubleshooting.....	65
9.3 Troubleshooting for Normal Malfunction.....	77
<b>10. Exploded View and Parts List.....</b>	<b>79</b>
10.1 Indoor Unit.....	79
10.2 Outdoor Unit.....	85
<b>11. Removal Procedure.....</b>	<b>93</b>
11.1 Removal Procedure of Indoor Unit.....	93
11.2 Removal Procedure of Outdoor Unit.....	100
<b>Appendix:.....</b>	<b>119</b>
Appendix 1: Reference Sheet of Celsius and Fahrenheit.....	119
Appendix 2: Configuration of Connection Pipe.....	119
Appendix 3: Pipe Expanding Method.....	120
Appendix 4: List of Resistance for Temperature Sensor.....	121

# 1. Summary

## Indoor Unit:

A1 panel (White)



A1 panel (Black)



A1 panel (Purple)



A1 panel (Silver)



A1 panel (Champagne)



## Remote Controller:

YBE1FB9



YBE1FB12



## Outdoor Unit:

GWH09AVCXB-K6DNA1B/O



GWH12AVCXD-K6DNA1A/O



GWH18AVDXE-K6DNA1A/O



GWH24AVEXF-K6DNA1A/O





**Model list:**

No.	Model	Product code	Indoor model	Indoor product code	Outdoor model	Outdoor product code	Remote Controller
1	GWH09AVCXB-K6DNA1B	CB601000400	GWH09AVCXB-K6DNA1B/I	CB601N00400	GWH09AVCXB-K6DNA1B/O	CB601W00400	YBE1FB9
2		CB601000401				CB601W00401	
3		CB601000402				CB601W00400	
4		CB601000403				CB601W00401	
5		CB601000404		CB601N00404		CB601W00400	YBE1FB12
6		CB601000405		CB601N00405			YBE1FB9
7		CB601000406		CB601N00406			
8		CB601000407		CB601N00404			YBE1FB12
9	GWH12AVCXD-K6DNA1A	CB601000100	GWH12AVCXD-K6DNA1A/I	CB601N00100	GWH12AVCXD-K6DNA1A/O	CB601W00100	YBE1FB9
10		CB601000101				CB601W00101	
11		CB601000104				CB601W00100	
12		CB601000105				CB601W00101	
13		CB601000106		CB601N00106		CB601W00100	YBE1FB12
14		CB601000107		CB601N00107			
15		CB601000108		CB601N00108			
16		CB601000109		CB601N00108			CB601W00101
17	GWH18AVDXE-K6DNA1A	CB601000300	GWH18AVDXE-K6DNA1A/I	CB601N00300	GWH18AVDXE-K6DNA1A/O	CB601W00300	YBE1FB9
18		CB601000301				CB601W00301	
19		CB601000304				CB601W00300	
20		CB601000305				CB601W00301	
21		CB601000306		CB601N00306		CB601W00300	YBE1FB12
22		CB601000307		CB601N00307			
23		CB601000308		CB601N00308			
24		CB601000310					CB601W00301
25	GWH24AVEXF-K6DNA1A	CB601000200	GWH24AVEXF-K6DNA1A/I	CB601N00200	GWH24AVEXF-K6DNA1A/O	CB601W00200	YBE1FB9
26		CB601000201				CB601W00201	
27		CB601000204				CB601W00200	
28		CB601000205				CB601W00201	
29		CB601000206		CB601N00206		CB601W00200	YBE1FB12
30		CB601000207		CB601N00207			
31		CB601000208		CB601N00208			YBE1FB9
32		CB601000210		CB601N00207			CB601W00201

## 2. Specifications

### 2.1 Specification Sheet

Model		-	GWH09AVCXB-K6DNA1B	
Product Code		-	CB601000400/CB601000402/ CB601000404/CB601000405/ CB601000406	CB601000401/CB601000403/ CB601000407
Power Supply	Rated Voltage	V~	220-240	
	Rated Frequency	Hz	50	
	Phases	-	1	
Power Supply Mode		-	Outdoor	
Cooling Capacity		W	2700	
Heating Capacity		W	3000	
Cooling Power Input		W	600	
Heating Power Input		W	680	
Cooling Current Input		A	3.2	
Heating Current Input		A	3.5	
Rated Input		W	1600	
Rated Cooling Current		A	6.3	
Rated Heating Current		A	7.1	
Air Flow Volume		m <sup>3</sup> /h	680/600/550/470/380/350/310/180	
Dehumidifying Volume		L/h	0.8	
EER		W/W	4.5	
COP		W/W	4.41	
SEER		-	9	
SCOP (Average/Warmer/Colder)		-	4.6/5.8/3.6	
Application Area		m <sup>2</sup>	12-18	
Model of indoor unit		-	GWH09AVCXB-K6DNA1B/I	
Indoor Unit Product Code		-	CB601N00400/CB601N00402/ CB601N00404/CB601N00405/ CB601N00406	CB601N00400/CB601N00402/ CB601N00404
Fan Type		-	Cross-flow	
Fan Diameter Length(DXL)		mm	Φ94×630	
Cooling Speed		r/min	1350/1200/1100/1000/920/850/750/500	
Heating Speed		r/min	1300/1200/1120/1050/980/900/850	
Fan Motor Power Output		W	15	
Fan Motor RLA		A	0.22	
Fan Motor Capacitor		μF	/	
Evaporator Form		-	Aluminum Fin-copper Tube	
Evaporator Pipe Diameter		mm	Φ5	
Evaporator Row-fin Gap		mm	2-1.3	
Evaporator Coil Length (LXDXW)		mm	634×22.8×266.7	
Swing Motor Model		-	MP24HF / MP24AQ / MP35CV	
Swing Motor Power Output		W	1.5 / 1.5 / 2.5	
Fuse Current		A	3.15	
Sound Pressure Level		dB (A)	Cooling: 41/38/36/34/30/26/22/19 Heating: 41/38/36/34/32/29/28	
Sound Power Level		dB (A)	Cooling: 59/52/50/48/44/40/36/33 Heating: 59/52/50/48/46/43/42	
Dimension (WXHXD)		mm	907X292X200	
Dimension of Carton Box (LXWXH)		mm	959X355X262	
Dimension of Package (LXWXH)		mm	965X371X273	
Net Weight		kg	10.5	
Gross Weight		kg	12.5	

Outdoor Unit	Outdoor Unit Model	-	GWH09AVCXB-K6DNA1B/O		
	Outdoor Unit Product Code	-	CB601W00400	CB601W00401	
	Compressor Manufacturer	-	ZHUHAI LANDA COMPRESSOR CO., LTD.		
	Compressor Model	-	QXF-A082zC170		
	Compressor Oil	-	ZE-G;ES RB68GX or equivalent		
	Compressor Type	-	Rotary		
	Compressor L.R.A.	A	15		
	Compressor RLA	A	2.56		
	Compressor Power Input	W	756.6		
	Compressor Overload Protector	-	/		
	Throttling Method	-	Electron expansion valve		
	Set Temperature Range	°C	16~30		
	Cooling Operation Ambient Temperature Range	°C	-15~50		
	Heating Operation Ambient Temperature Range	°C	-25~30	-15~30	
	Condenser Form	-	Aluminum Fin-copper Tube		
	Condenser Pipe Diameter	mm	Φ7		
	Condenser Rows-fin Gap	mm	2-1.4		
	Condenser Coil Length (LXDXW)	mm	666×38.1×527		
	Fan Motor Speed	rpm	850		
	Fan Motor Power Output	W	30		
	Fan Motor RLA	A	0.4		
	Fan Motor Capacitor	μF	/		
	Outdoor Unit Air Flow Volume	m <sup>3</sup> /h	1950		
	Fan Type	-	Axial-flow		
	Fan Diameter	mm	Φ400		
	Defrosting Method	-	Automatic Defrosting		
	Climate Type	-	T1		
	Isolation	-	I		
	Moisture Protection	-	IPX4		
	Permissible Excessive Operating Pressure for the Discharge Side	MPa	4.3		
	Permissible Excessive Operating Pressure for the Suction Side	MPa	2.5		
	Sound Pressure Level	dB (A)	50		
	Sound Power Level	dB (A)	62		
Dimension(WXHXD)	mm	732X555X330			
Dimension of Carton Box (LXWXH)	mm	791X373X590			
Dimension of Package(LXWXH)	mm	794X376X615			
Net Weight	kg	27			
Gross Weight	kg	29.5			
Refrigerant	-	R32			
Refrigerant Charge	kg	0.7			
Connection Pipe	Connection Pipe Length	m	5		
	Connection Pipe Gas Additional Charge	g/m	16		
	Outer Diameter Liquid Pipe	inch	1/4		
	Outer Diameter Gas Pipe	inch	3/8		
	Max Distance Height	m	10		
	Max Distance Length	m	15		
Note: The connection pipe applies metric diameter.					

The above data is subject to change without notice. Please refer to the nameplate of the unit.



Outdoor Unit	Outdoor Unit Model	-	GWH12AVCXD-K6DNA1A/O		
	Outdoor Unit Product Code	-	CB601W00100	CB601W00101	
	Compressor Manufacturer	-	ZHUHAI LANDA COMPRESSOR CO., LTD.		
	Compressor Model	-	QXF-A098zE170		
	Compressor Oil	-	ZE-GLES RB68GX or equivalent		
	Compressor Type	-	Rotary		
	Compressor L.R.A.	A	18		
	Compressor RLA	A	3.9		
	Compressor Power Input	W	847		
	Compressor Overload Protector	-	/		
	Throttling Method	-	Electron expansion valve		
	Set Temperature Range	°C	16~30		
	Cooling Operation Ambient Temperature Range	°C	-15~50		
	Heating Operation Ambient Temperature Range	°C	-25~30	-15~30	
	Condenser Form	-	Aluminum Fin-copper Tube		
	Condenser Pipe Diameter	mm	Φ7		
	Condenser Rows-fin Gap	mm	2-1.4		
	Condenser Coil Length (LXDXW)	mm	761.5×38.1×528		
	Fan Motor Speed	rpm	850		
	Fan Motor Power Output	W	30		
	Fan Motor RLA	A	0.4		
	Fan Motor Capacitor	μF	/		
	Outdoor Unit Air Flow Volume	m <sup>3</sup> /h	2200		
	Fan Type	-	Axial-flow		
	Fan Diameter	mm	Φ420		
	Defrosting Method	-	Automatic Defrosting		
	Climate Type	-	T1		
	Isolation	-	I		
	Moisture Protection	-	IPX4		
	Permissible Excessive Operating Pressure for the Discharge Side	MPa	4.3		
	Permissible Excessive Operating Pressure for the Suction Side	MPa	2.5		
	Sound Pressure Level	dB (A)	53		
	Sound Power Level	dB (A)	64		
Dimension(WXHXD)	mm	802X555X350			
Dimension of Carton Box (LXWXH)	mm	869X395X594			
Dimension of Package(LXWXH)	mm	872X398X620			
Net Weight	kg	30			
Gross Weight	kg	32.5			
Refrigerant	-	R32			
Refrigerant Charge	kg	0.8			
Connection Pipe	Connection Pipe Length	m	5		
	Connection Pipe Gas Additional Charge	g/m	16		
	Outer Diameter Liquid Pipe	inch	1/4		
	Outer Diameter Gas Pipe	inch	3/8		
	Max Distance Height	m	10		
	Max Distance Length	m	20		
Note: The connection pipe applies metric diameter.					

The above data is subject to change without notice. Please refer to the nameplate of the unit.

Model		-	GWH18AVDXE-K6DNA1A	
Product Code		-	CB601000300/CB601000304/ CB601000306/CB601000307/ CB601000308	CB601000301/CB601000305/ CB601000310
Power Supply	Rated Voltage	V~	220-240	
	Rated Frequency	Hz	50	
	Phases	-	1	
Power Supply Mode		-	Outdoor	
Cooling Capacity		W	5300	
Heating Capacity		W	5600	
Cooling Power Input		W	1472	
Heating Power Input		W	1365	
Cooling Current Input		A	6.6	
Heating Current Input		A	6.2	
Rated Input		W	2300	
Rated Cooling Current		A	11.5	
Rated Heating Current		A	11.5	
Air Flow Volume		m <sup>3</sup> /h	1100/1000/910/850/790/730/660/360	
Dehumidifying Volume		L/h	1.8	
EER		W/W	3.6	
COP		W/W	4.1	
SEER		-	8.5	
SCOP (Average/Warmer/Colder)		-	4.6/5.8/3.7	
Application Area		m <sup>2</sup>	23-34	
Indoor Unit	Model of indoor unit		GWH18AVDXE-K6DNA1A/I	
	Indoor Unit Product Code		CB601N00300/CB601N00304/ CB601N00306/CB601N00307/ CB601N00308	CB601N00300/CB601N00304/ CB601N00308
	Fan Type		Cross-flow	
	Fan Diameter Length(DXL)		Φ108X691	
	Cooling Speed		1080/1040/1000/960/800/700/650/500	
	Heating Speed		1200/1150/1040/980/930/880/800	
	Fan Motor Power Output		45	
	Fan Motor RLA		0.25	
	Fan Motor Capacitor		/	
	Evaporator Form		Aluminum Fin-copper Tube	
	Evaporator Pipe Diameter		Φ5	
	Evaporator Row-fin Gap		2-1.2	
	Evaporator Coil Length (LXD <sub>X</sub> W)		701×22.8×381	
	Swing Motor Model		MP24HF / MP24AQ / MP35CV	
	Swing Motor Power Output		1.5 / 1.5 / 2.5	
	Fuse Current		3.15	
	Sound Pressure Level		Cooling: 45/43/42/41/35/31/28/23 Heating: 47/45/42/40/39/37/34	
	Sound Power Level		Cooling: 60/58/57/56/50/46/43/38 Heating: 60/58/55/53/52/50/47	
	Dimension (WXH <sub>X</sub> D)		970X347X257	
	Dimension of Carton Box (LXWXH)		1022X411X329	
	Dimension of Package (LXWXH)		1027X419X339	
	Net Weight		15	
Gross Weight		17.5		



Outdoor Unit	Outdoor Unit Model	-	GWH18AVDXE-K6DNA1A/O		
	Outdoor Unit Product Code	-	CB601W00300	CB601W00301	
	Compressor Manufacturer	-	ZHUHAI LANDA COMPRESSOR CO., LTD.		
	Compressor Model	-	QXF-M130zF170		
	Compressor Oil	-	FW68DA or equivalent		
	Compressor Type	-	Rotary		
	Compressor L.R.A.	A	20		
	Compressor RLA	A	5.36		
	Compressor Power Input	W	1196		
	Compressor Overload Protector	-	/		
	Throttling Method	-	Electron expansion valve		
	Set Temperature Range	°C	Cooling mode: 16~30 / Heating mode: 8~30		
	Cooling Operation Ambient Temperature Range	°C	-15~50		
	Heating Operation Ambient Temperature Range	°C	-25~30	-15~30	
	Condenser Form	-	Aluminum Fin-copper Tube		
	Condenser Pipe Diameter	mm	Φ7.94		
	Condenser Rows-fin Gap	mm	2-1.4		
	Condenser Coil Length (LXDXW)	mm	833×38.1×528		
	Fan Motor Speed	rpm	970		
	Fan Motor Power Output	W	40		
	Fan Motor RLA	A	0.7		
	Fan Motor Capacitor	μF	/		
	Outdoor Unit Air Flow Volume	m <sup>3</sup> /h	3000		
	Fan Type	-	Axial-flow		
	Fan Diameter	mm	Φ445		
	Defrosting Method	-	Automatic Defrosting		
	Climate Type	-	T1		
	Isolation	-	I		
	Moisture Protection	-	IPX4		
	Permissible Excessive Operating Pressure for the Discharge Side	MPa	4.3		
	Permissible Excessive Operating Pressure for the Suction Side	MPa	2.5		
	Sound Pressure Level	dB (A)	59		
	Sound Power Level	dB (A)	65		
Dimension(WXHXD)	mm	873X555X376			
Dimension of Carton Box (LXWXH)	mm	948X428X591			
Dimension of Package(LXWXH)	mm	951X431X620			
Net Weight	kg	37			
Gross Weight	kg	40			
Refrigerant	-	R32			
Refrigerant Charge	kg	0.95			
Connection Pipe	Connection Pipe Length	m	5		
	Connection Pipe Gas Additional Charge	g/m	16		
	Outer Diameter Liquid Pipe	inch	1/4		
	Outer Diameter Gas Pipe	inch	1/2		
	Max Distance Height	m	10		
	Max Distance Length	m	25		
Note: The connection pipe applies metric diameter.					

The above data is subject to change without notice. Please refer to the nameplate of the unit.



Outdoor Unit	Outdoor Unit Model	-	GWH24AVEXF-K6DNA1A/O		
	Outdoor Unit Product Code	-	CB601W00200	CB601W00201	
	Compressor Manufacturer	-	ZHUHAI LANDA COMPRESSOR CO., LTD.		
	Compressor Model	-	QXFS-A150zX170S		
	Compressor Oil	-	FW68DA or equivalent		
	Compressor Type	-	Rotary		
	Compressor L.R.A.	A	35		
	Compressor RLA	A	11.35		
	Compressor Power Input	W	1330		
	Compressor Overload Protector	-	/		
	Throttling Method	-	Electron expansion valve		
	Set Temperature Range	°C	Cooling mode: 16~30 / Heating mode: 8~30		
	Cooling Operation Ambient Temperature Range	°C	-15~50		
	Heating Operation Ambient Temperature Range	°C	-25~30	-15~30	
	Condenser Form	-	Aluminum Fin-copper Tube		
	Condenser Pipe Diameter	mm	Φ7		
	Condenser Rows-fin Gap	mm	2-1.4		
	Condenser Coil Length (LXDXW)	mm	890×38.1×616		
	Fan Motor Speed	rpm	800		
	Fan Motor Power Output	W	60		
	Fan Motor RLA	A	0.65		
	Fan Motor Capacitor	μF	/		
	Outdoor Unit Air Flow Volume	m <sup>3</sup> /h	3200		
	Fan Type	-	Axial-flow		
	Fan Diameter	mm	Φ520		
	Defrosting Method	-	Automatic Defrosting		
	Climate Type	-	T1		
	Isolation	-	I		
	Moisture Protection	-	IPX4		
	Permissible Excessive Operating Pressure for the Discharge Side	MPa	4.3		
	Permissible Excessive Operating Pressure for the Suction Side	MPa	2.5		
	Sound Pressure Level	dB (A)	60		
	Sound Power Level	dB (A)	70		
Dimension(WXHXD)	mm	958X660X402			
Dimension of Carton Box (LXWXH)	mm	1029X453X715			
Dimension of Package(LXWXH)	mm	1032X456X737			
Net Weight	kg	42.5			
Gross Weight	kg	47			
Refrigerant	-	R32			
Refrigerant Charge	kg	1.4			
Connection Pipe	Connection Pipe Length	m	5		
	Connection Pipe Gas Additional Charge	g/m	40		
	Outer Diameter Liquid Pipe	inch	1/4		
	Outer Diameter Gas Pipe	inch	5/8		
	Max Distance Height	m	10		
	Max Distance Length	m	25		
Note: The connection pipe applies metric diameter.					

The above data is subject to change without notice. Please refer to the nameplate of the unit.

## 2.2 Capacity Variation Ratio According to Temperature

Cooling:

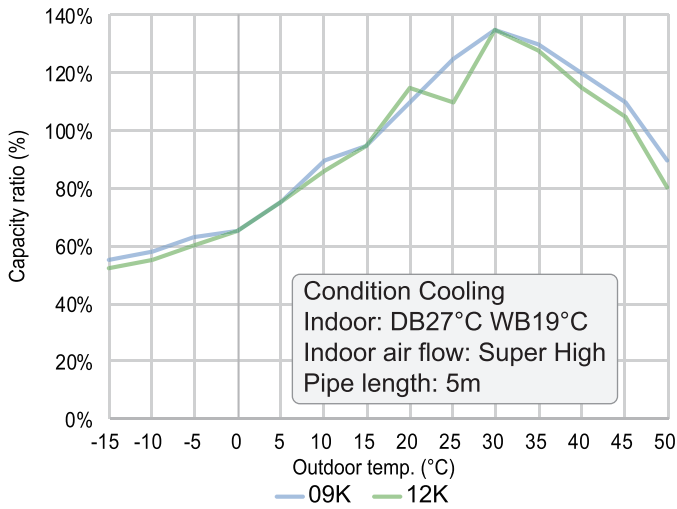

Heating:

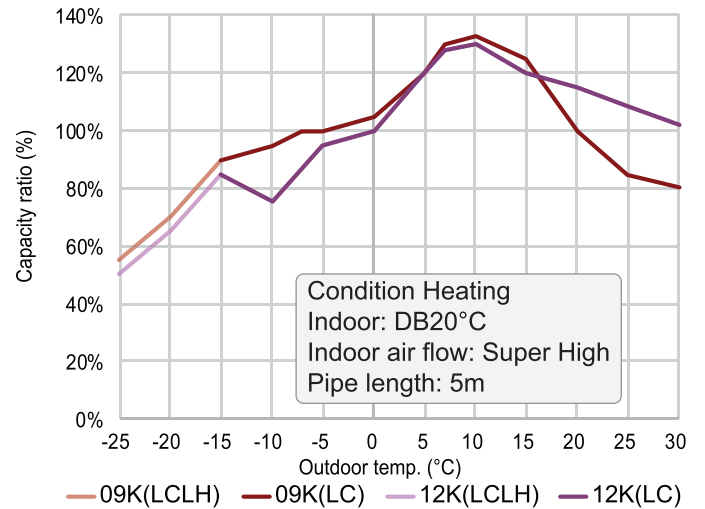

Cooling:

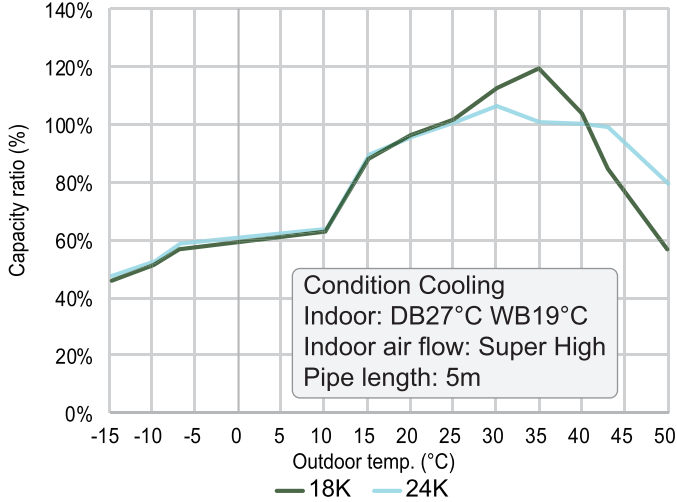

Heating:

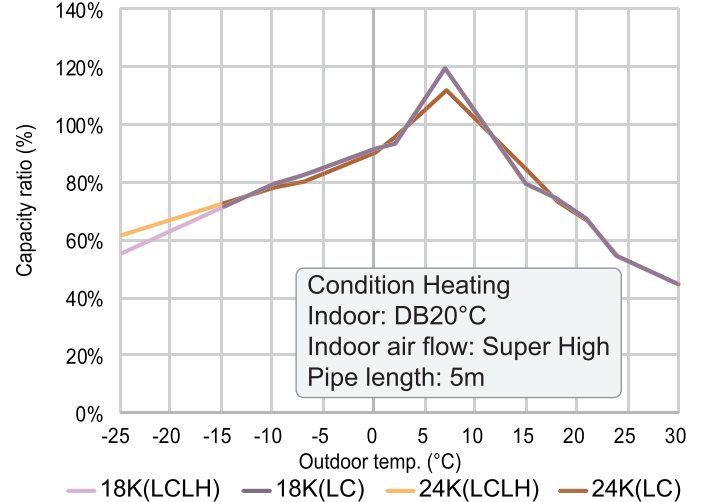

## 2.3 Cooling and Heating Data Sheet in Rated Frequency

Cooling:

Rated cooling condition(°C) (DB/WB)		Model	Pressure of gas pipe connecting indoor and outdoor unit	Inlet and outlet pipe temperature of heat exchanger		Fan speed of indoor unit	Fan speed of outdoor unit
Indoor	Outdoor			T1 (°C)	T2 (°C)		
27/19	35/24	09K	0.8 ~ 1.1	12 ~ 15	68 ~ 38	Super High	High
27/19	35/24	12K	0.9 ~ 1.1	12 ~ 14	75 ~ 37	Super High	High
27/19	35/24	18K	0.9 ~ 1.1	12 ~ 14	75 ~ 37	Super High	High
27/19	35/24	24K	0.9 ~ 1.1	12 ~ 14	75 ~ 37	Super High	High

Heating:

Rated heating condition(°C) (DB/WB)		Model	Pressure of gas pipe connecting indoor and outdoor unit	Inlet and outlet pipe temperature of heat exchanger		Fan speed of indoor unit	Fan speed of outdoor unit
Indoor	Outdoor			T1 (°C)	T2 (°C)		
20/-	7/6	09K	2.8 ~ 3.2	63 ~ 35	2 ~ 5	Super High	High
20/-	7/6	12K	2.2 ~ 2.4	70 ~ 35	2 ~ 4	Super High	High
20/-	7/6	18K	2.2 ~ 2.4	70 ~ 40	1 ~ 5	Super High	High
20/-	7/6	24K	2.2 ~ 2.4	70 ~ 35	2 ~ 4	Super High	High

**Instruction:**

T1: Inlet and outlet pipe temperature of evaporator

T2: Inlet and outlet pipe temperature of condenser

P: Pressure at the side of big valve

Connection pipe length: 5 m.

# 3. Outline Dimension Diagram

## 3.1 Indoor Unit

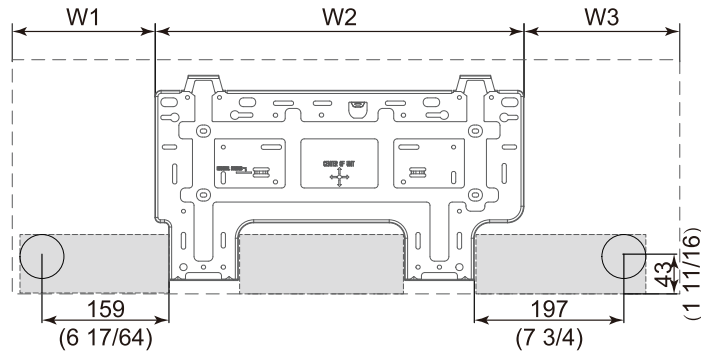
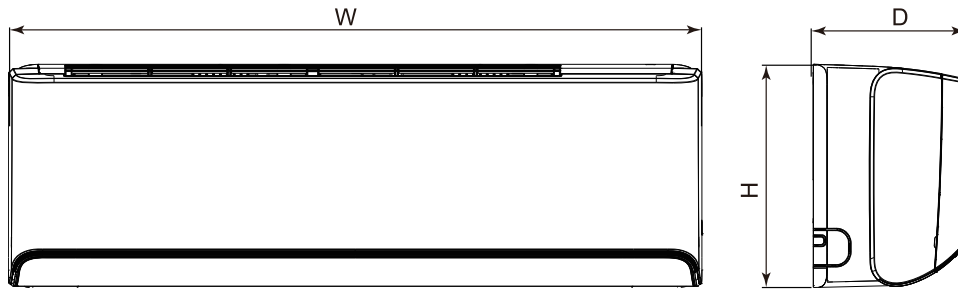

AVC

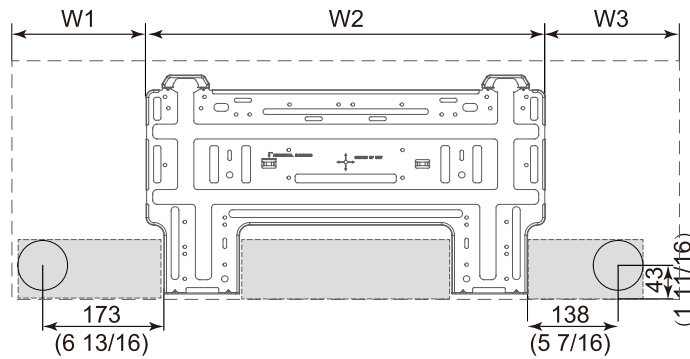

AVD

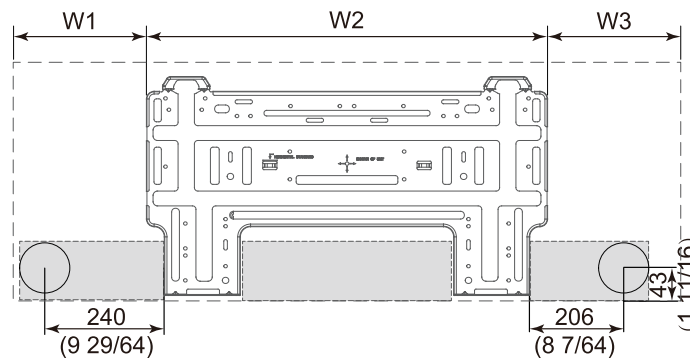

AVE

Unit: mm(inch)

Unit: mm

Model	W	H	D	W1	W2	W3
AVC	907	292	200	216	462	229
AVD	970	347	257	205.3	561.5	203.2
AVE	1110	347	257	275.4	561.5	273.1

## 3.2 Outdoor Unit

09K

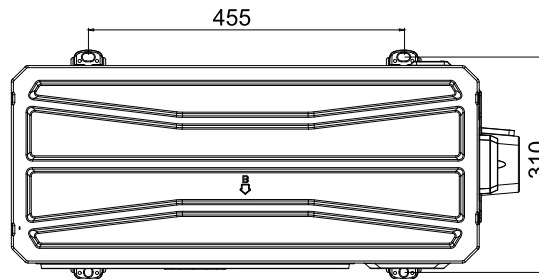
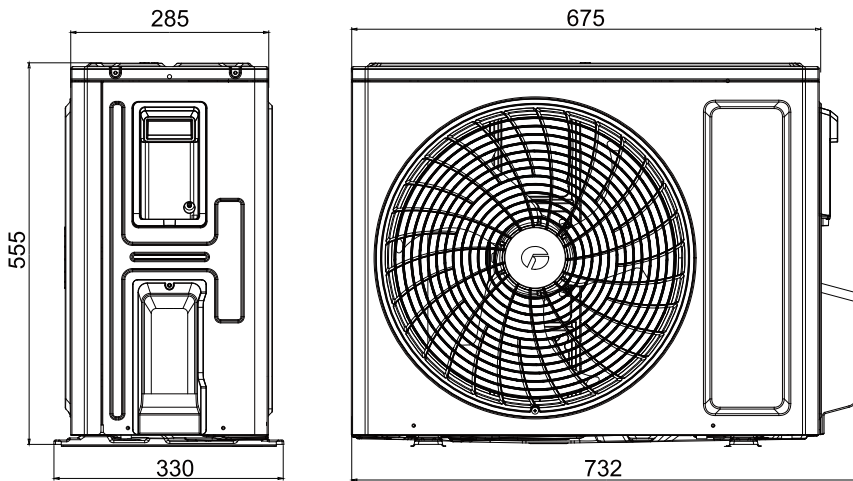

Unit: mm

12K

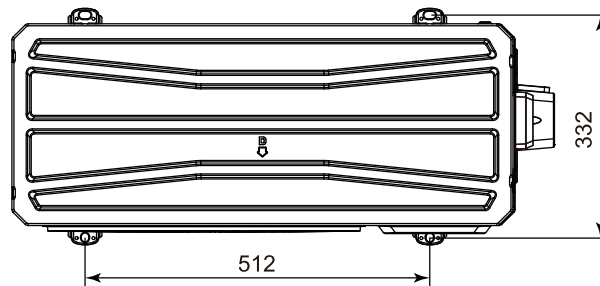
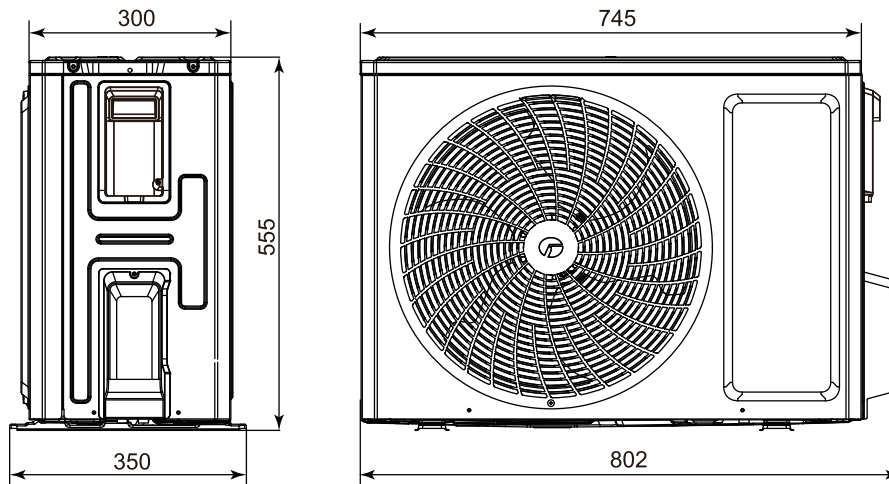

Unit: mm



18K

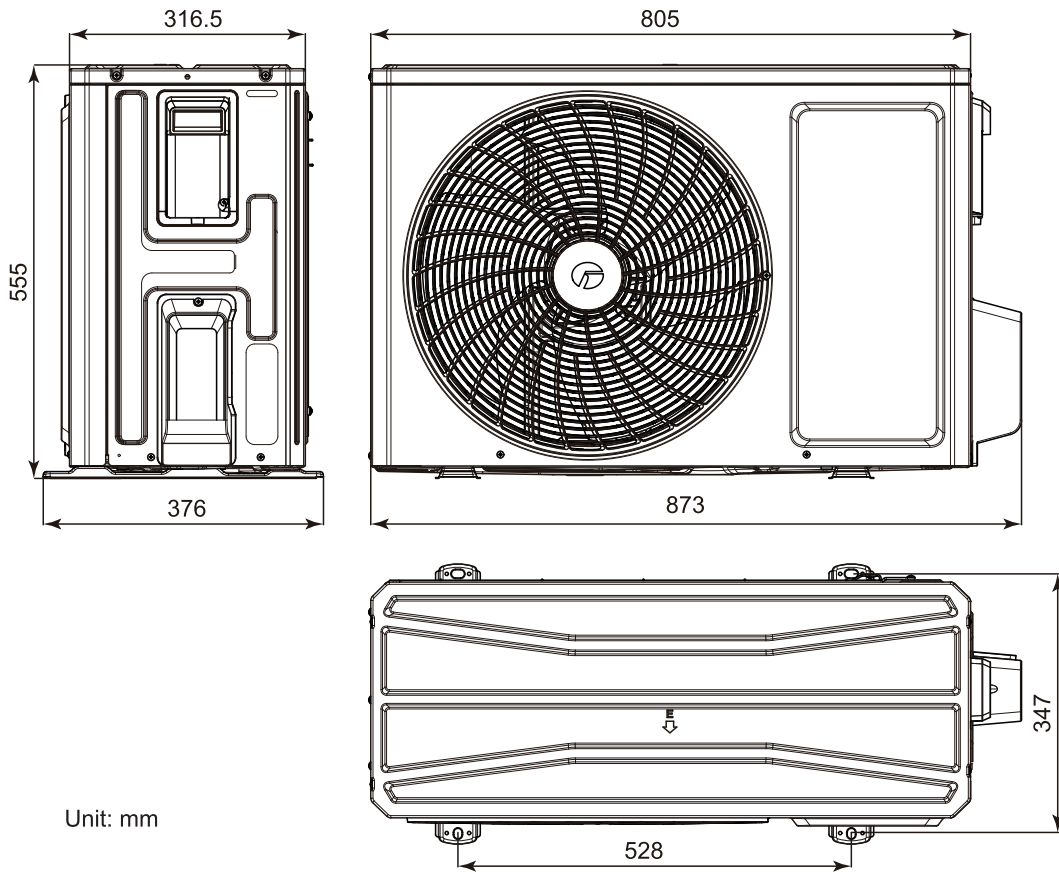

24K

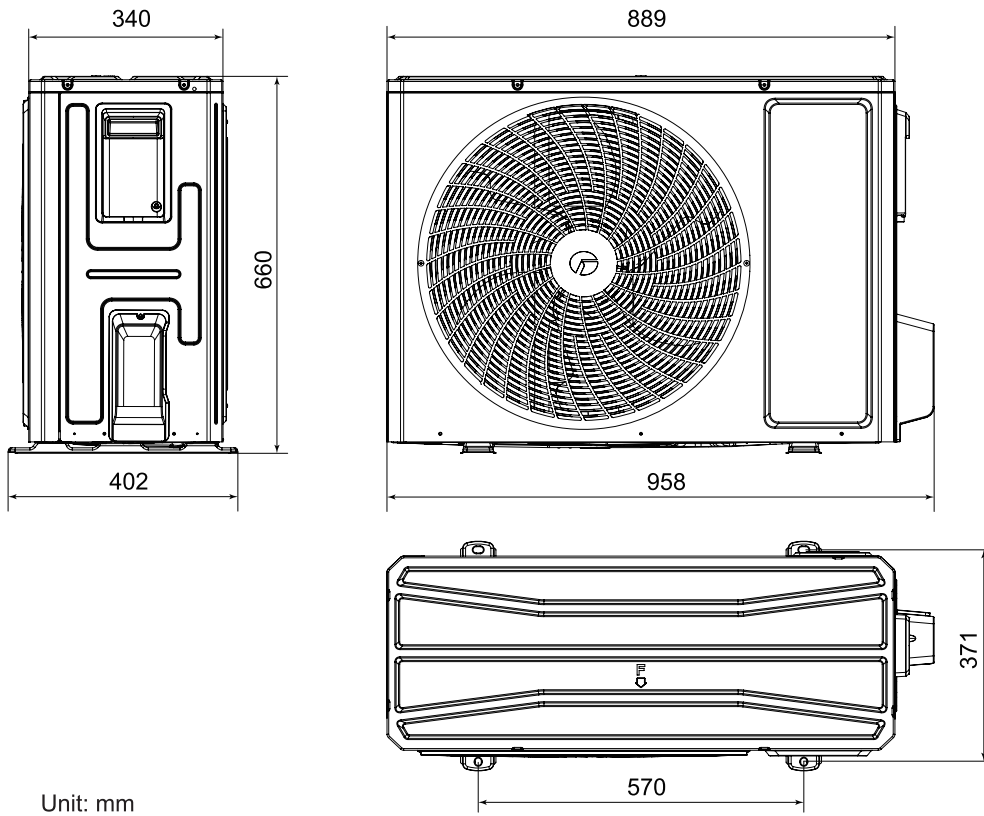



# 5. Electrical Part

## 5.1 Wiring Diagram

### • Instruction

Symbol	Symbol Color	Symbol	Symbol Color	Symbol	Name
WH	White	GN	Green	CAP	Jumper cap
YE	Yellow	BN	Brown	COMP	Compressor
RD	Red	BU	Blue		Grounding wire
YEGN	Yellow/Green	BK	Black	/	/
VT	Violet	OG	Orange	/	/

Note: Jumper cap is used to determine fan speed and the swing angle of horizontal lever for this model.

### • Indoor Unit

GWH09AVCXB-K6DNA1B/I    GWH12AVCXD-K6DNA1A/I

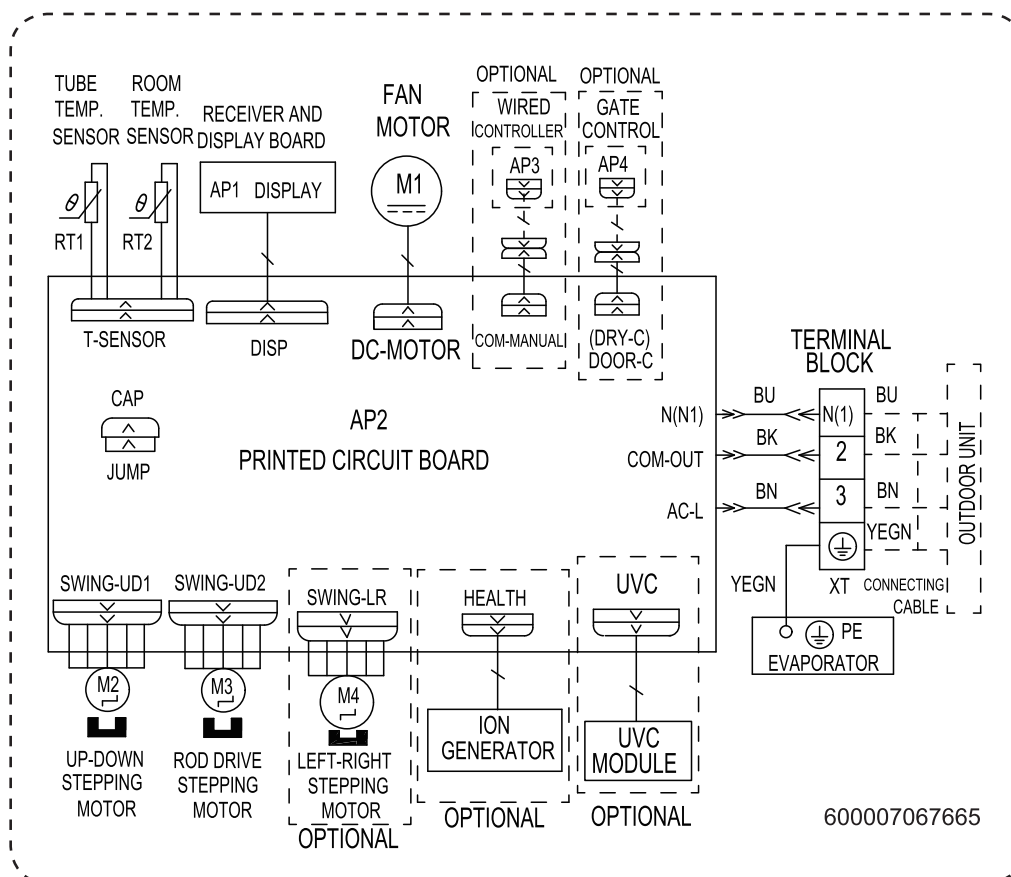

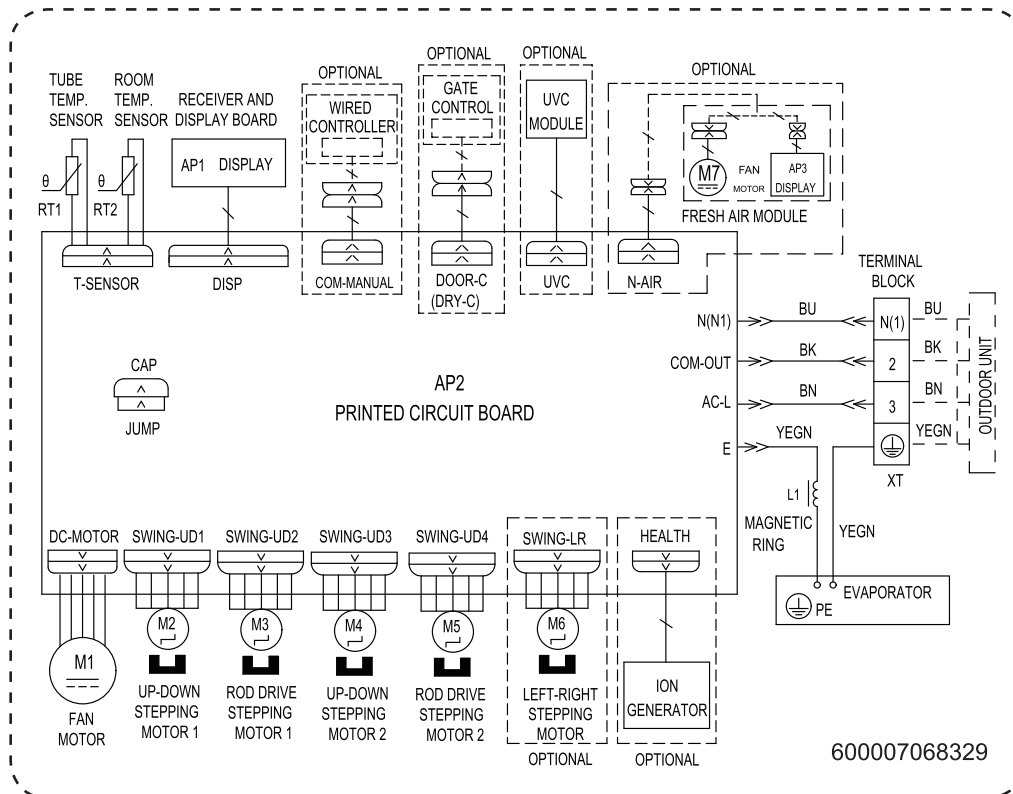
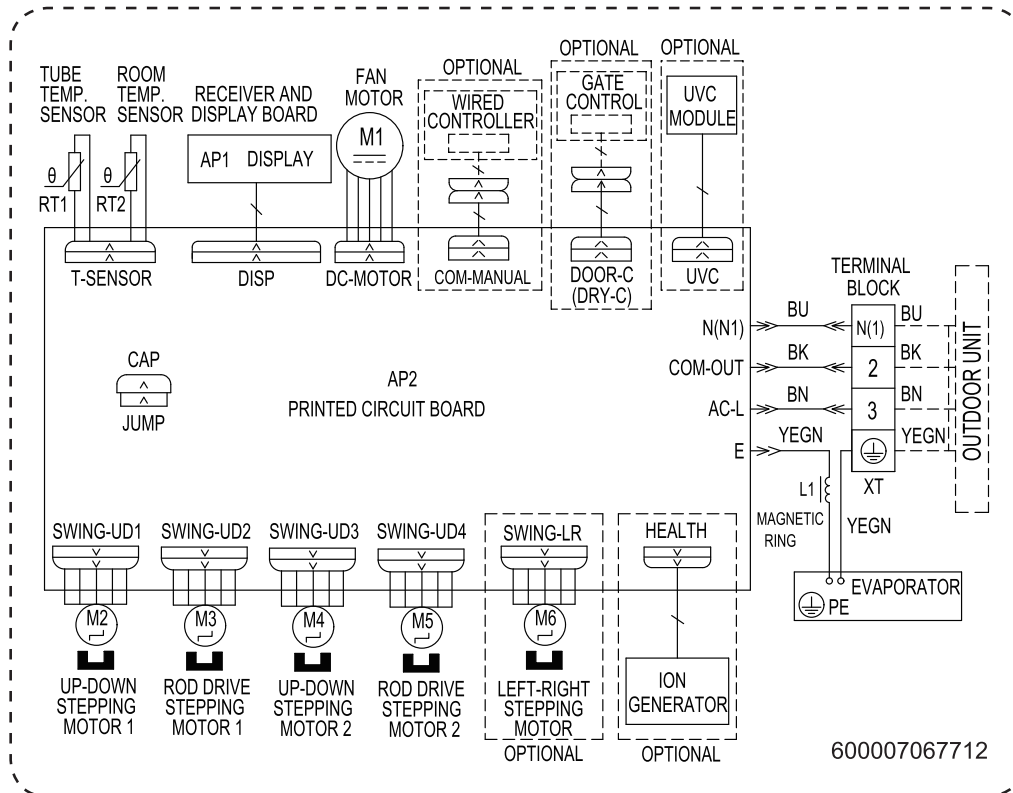

● Outdoor Unit

GWH09AVCXB-K6DNA1B/O GWH12AVCXD-K6DNA1A/O

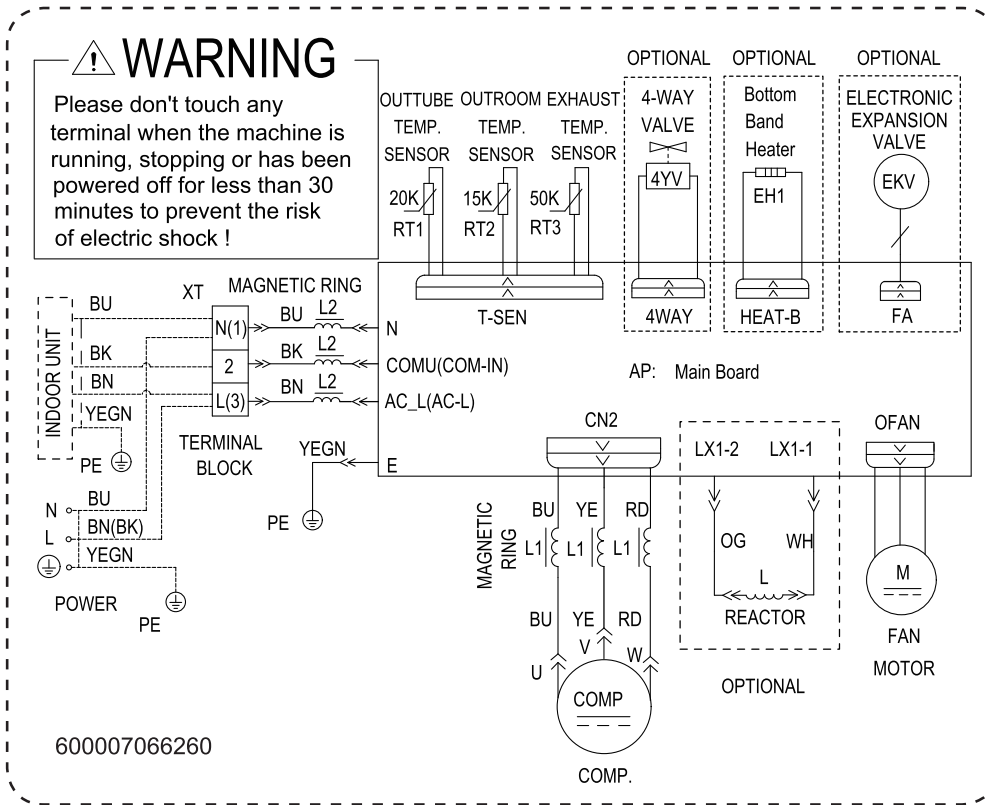

GWH18AVDXE-K6DNA1A/O GWH24AVEXF-K6DNA1A/O

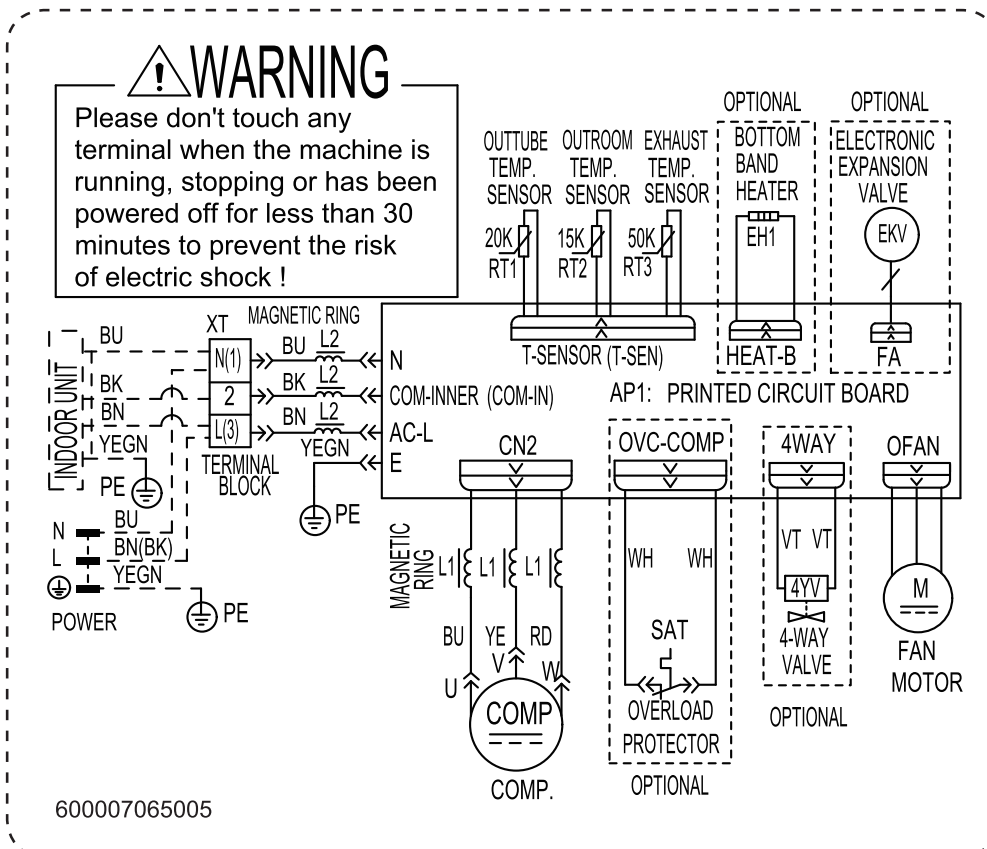

These wiring diagrams are subject to change without notice; please refer to the one supplied with the unit.

## 5.2 PCB Printed Diagram

### • Indoor Unit

GWH09AVCXB-K6DNA1B/I    GWH12AVCXD-K6DNA1A/I    GWH18AVDXE-K6DNA1A/I    GWH24AVEXF-K6DNA1A/I

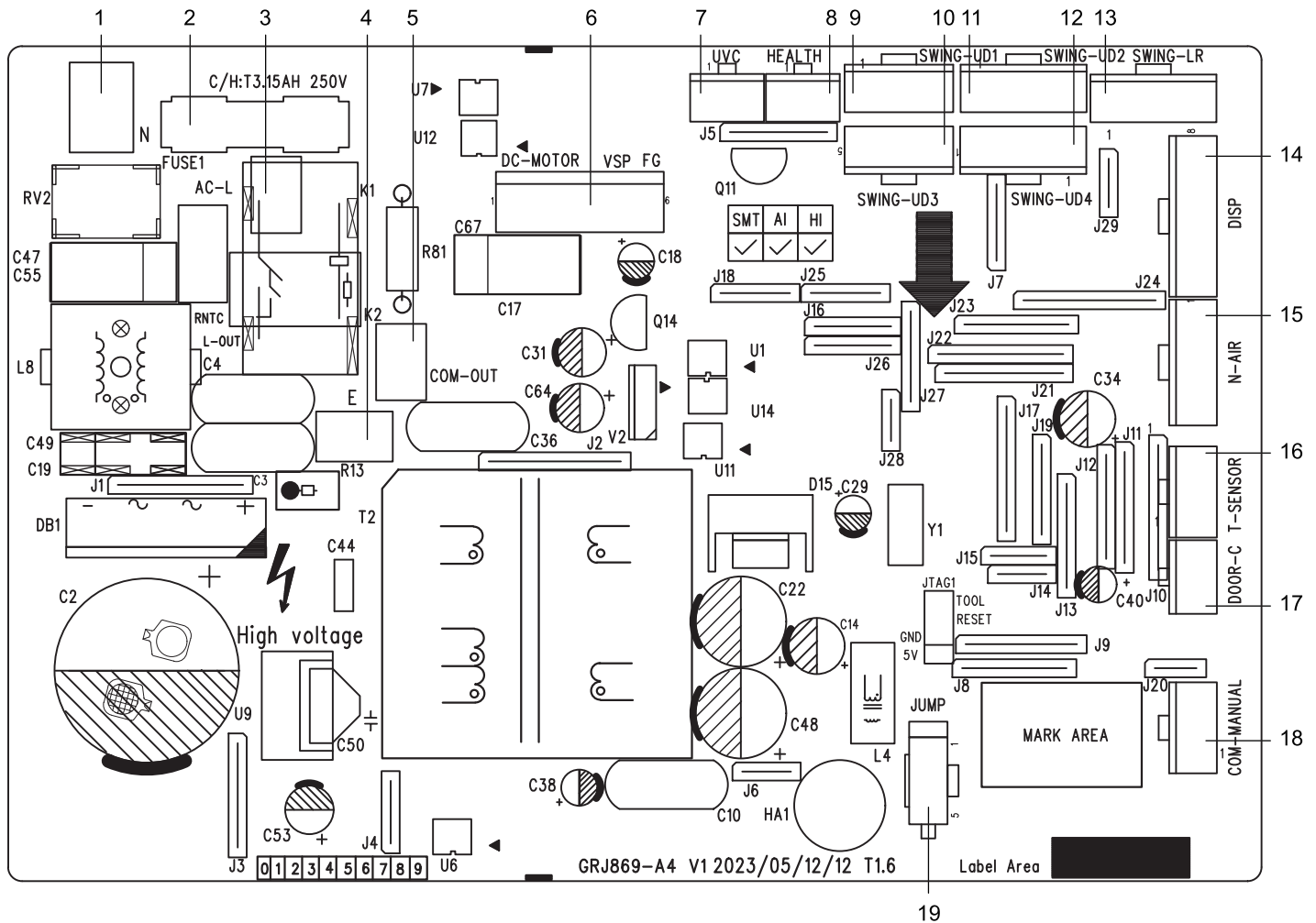

No.	Name	No.	Name
1	Neutral Wire Insertion	11	Stepping Motor Needle Stand 2
2	Fuse	12	Stepping Motor Needle Stand 4
3	Live Wire Insertion	13	Left & Right Swing Needle Stand
4	Earthing Wire Insertion	14	Display Board Needle Stand
5	Communication Wire Insertion	15	Fresh air Function Needle Stand
6	Brushless DC Motor Needle Stand	16	Temperature Sensor Needle Stand
7	Ultraviolet cleaning Needle Stand	17	Door Control Needle Stand
8	Health Function Needle Stand	18	Wired Controller Needle Stand
9	Up & Down Swing Needle Stand 1	19	Jumper Needle Stand
10	Up & Down Swing Needle Stand 3		



● Outdoor Unit

GWH09AVCXB-K6DNA1B/O GWH12AVCXD-K6DNA1A/O

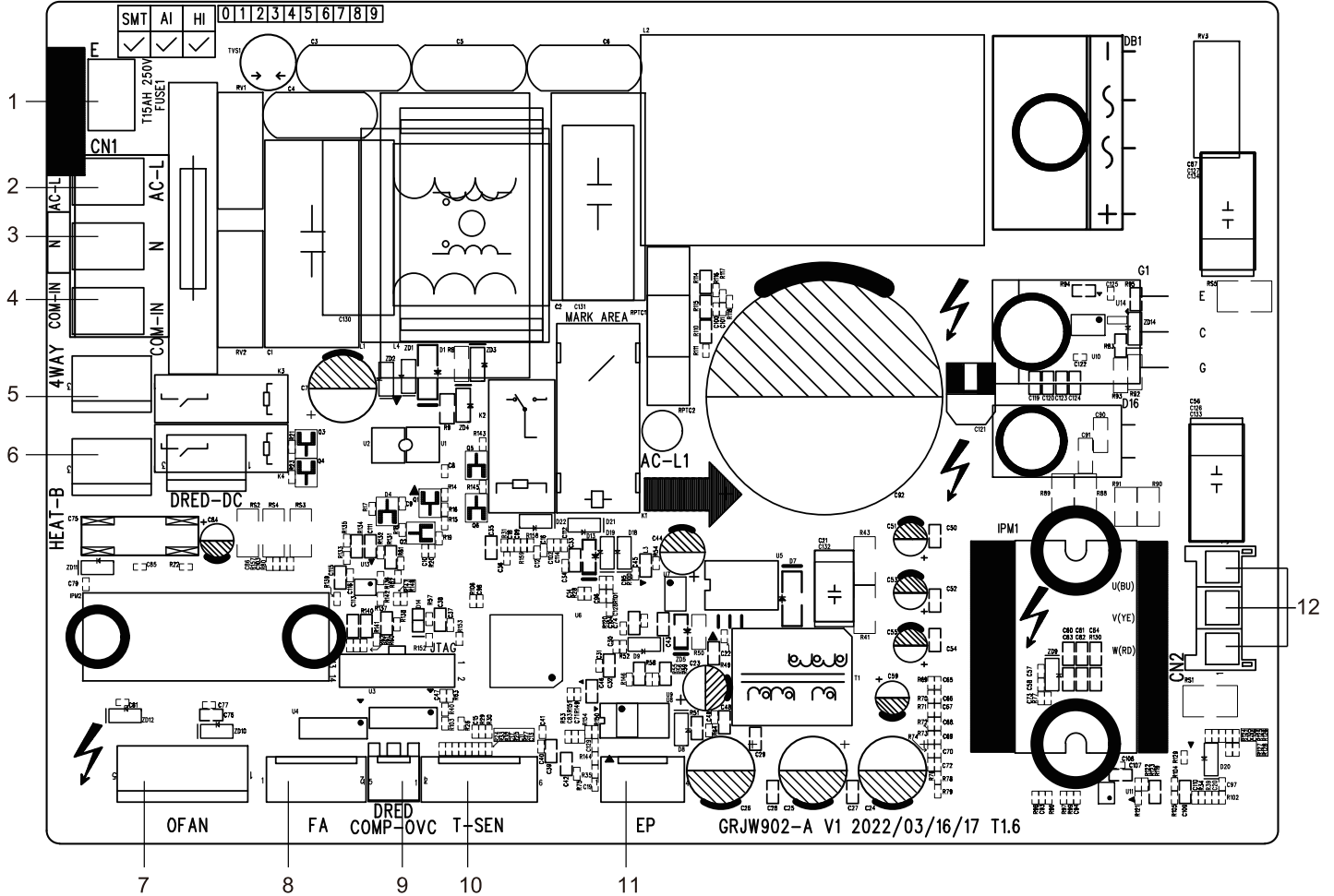

No.	Name	No.	Name
1	Earthing Wire Insertion	7	Outdoor Fan Needle Stand
2	Live Wire Insertion	8	Electronic Expansion Valve Needle Stand
3	Neutral Wire Insertion	9	Compressor Overload Needle Stand
4	Communication Wire Insertion	10	Temperature Sensor Needle Stand
5	Four-way Valve Needle Stand	11	EEP Flash Drive Needle Stand
6	Chassis Electric Heating Belt Needle Stand	12	Compressor Needle Stand



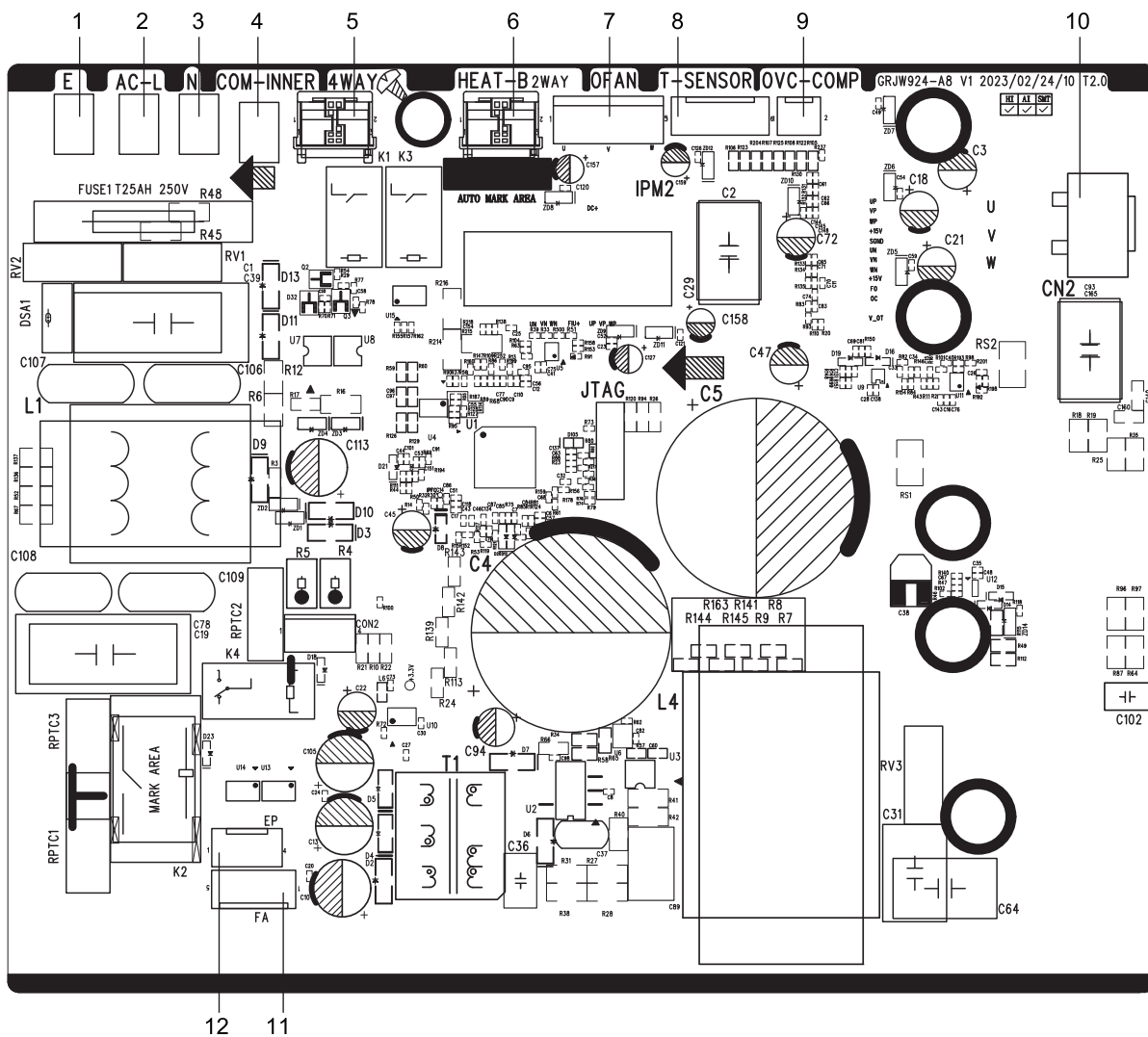

No.	Name	No.	Name
1	Earthing Wire Insertion	7	Outdoor Fan Needle Stand
2	Live Wire Insertion	8	Temperature Sensor Needle Stand
3	Neutral Wire Insertion	9	Compressor Overload Needle Stand
4	Communication Wire Insertion	10	Compressor Needle Stand
5	Four-way Valve Needle Stand	11	Electronic Expansion Valve Needle Stand
6	Chassis Electric Heating Belt Needle Stand	12	EEP Flash Drive Needle Stand

# 6. Function and Control

## 6.1 Remote Controller Introduction for YBE1FB9

### Buttons on remote controller



### Introduction for icons on display screen

	Quiet
	Set fan speed
	Turbo mode
	Send signal
	Auto mode
	Cool mode
	Dry mode
	Fan mode
	Heat mode
	X-FAN function
	Humidity control
	Power limiting operation
	Set temperature
	Indoor ambient temp.
	Indoor ambient humidity
	TIMER ON / TIMER OFF
	Set time
	Left & right swing
	Up & down swing
	Child lock
	Fast cool
	Health and UVC functions
	WiFi function
	LED
	Auto LED
	I feel
	Sleep mode
	Two-way ventilation function

#### NOTE:

- This is a general use remote controller. It could be used for the air conditioner with multifunction. For the functions which the model doesn't have, if press the corresponding button on the remote controller, the unit will keep the original running status.
- After putting through the power, the air conditioner will give out a sound. Power indicator " " is ON. After that, you can operate the air conditioner by using remote controller.
- Under on status, pressing the button on the remote controller, the signal icon " " on the display of remote controller will blink once and the air conditioner will give out a "di" sound, which means the signal has been sent to the air conditioner.

#### 1. On/Off button

Press this button to turn on the unit. Press this button again to turn off the unit.

#### 2. Mode button

Press this button to select your required operation mode:

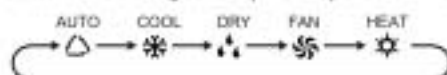

- When selecting auto mode, air conditioner will operate automatically according to ambient temperature. Press "Fan" button can adjust fan speed. Press " " / " " button can adjust fan blowing angle.
- After selecting cool mode, air conditioner will operate under cool mode. Press " + " or " - " button to adjust set temperature. Press "Fan" button to adjust fan speed. Press " " / " " button to adjust fan blowing angle.
- When selecting dry mode, the air conditioner operates at low speed under dry mode. Under dry mode, fan speed can't be adjusted. Press " " / " " button to adjust fan blowing angle.
- When selecting fan mode, the air conditioner will only blow fan, no cooling and no heating. Press "Fan" button to adjust fan speed. Press " " / " " button to adjust fan blowing angle.
- When selecting heat mode, the air conditioner operates under heat mode. Press " + " or " - " button to adjust set temperature. Press "Fan" button to adjust fan speed. Press " " / " " button to adjust fan blowing angle.

#### NOTE:

- For preventing cold air, after starting up heat mode, indoor unit will delay 1~5 minutes to blow air (Actual delay time depends on indoor ambient temperature).

- Set temperature range from remote controller: 16~30°C (61~86°F).
- This mode indicator is not available for some models.
- Cooling only unit won't receive heat mode signal. If setting heat mode with remote controller, press "On/Off" button can't start up the unit.

### 3. Fan button

This button is used for setting Fan Speed in the sequence that goes from AUTO, , , , , , to then back to Auto.

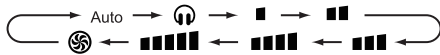

- Low speed
- Low-Medium speed
- Medium speed
- Medium-High speed
- High speed
- Turbo speed
- Quiet speed

#### NOTE:

- It's low fan speed under dry mode.
- X-FAN function: Holding fan speed button for 2s in cool or dry mode, the icon is displayed and the indoor fan will continue operation for a few minutes in order to dry the indoor unit even though you have turned off the unit. After energization, X-FAN OFF is defaulted. X-FAN is not available in auto, fan or heat mode.

This function indicates that moisture on evaporator of indoor unit will be blown after the unit is stopped to avoid mould.

- Having set X-FAN function on: After turning off the unit by pressing "On/Off" button, indoor fan will continue running for a few minutes at low speed. In this period, hold fan speed button for 2s to stop indoor fan directly.
- Having set X-FAN function off: After turning off the unit by pressing "On/Off" button, the complete unit will be off directly.

### 4. - / + button

Press " + " or " - " button once increase or decrease set temperature 1°C(°F). Holding " + " or " - " button, 2s later, set temperature on remote controller will change quickly. On releasing button after setting is finished, temperature indicator on indoor unit will change accordingly.

### 5. Wifi button

Press "Wifi" button to turn on WiFi function, "Wifi" icon will be displayed on the remote controller; Hold "Wifi" button for 5s to turn off WiFi function and "Wifi" icon will disappear. Under off status, press "Mode" and "Wifi" buttons simultaneously for 1s, WiFi module will restore factory settings.

#### NOTE:

- This function is only available for some models.

### 6. Health button

Press this button to turn on or turn off the health function and UVC lamp in operation status.



- When selecting " " with remote controller, Cold Plasma will be turn on.
- When selecting " " with remote controller, UVC lamp will be turn on.
- When selecting " " with remote controller, Cold Plasma and UVC lamp will be turn on together.

#### NOTE:

- Health function and UVC lamp are only available for some models.

### 7. UD-swing button

Press this button can select up & down swing angle. Fan blow angle can be selected circularly as below:

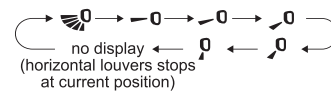

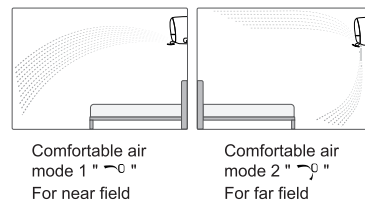

- When selecting " ", air conditioner is blowing fan automatically. Horizontal louver will automatically swing up & down at maximum angle.
- When selecting " , , , , ", air conditioner is blowing fan at fixed position. Horizontal louver will stop at the fixed position.
- Hold " " button above 2s to set your required swing angle. When reaching your required angle, release the button.
- Under cooling, press this button to set comfortable air mode 1 " " and comfortable air mode 2 " ". The recommended applicable scenes of comfortable air modes are as follows:



#### NOTE:

- Press this button continuously more than 2s, the main unit will swing back and forth from up to down, and then loosen the button, the unit will stop swinging and present position of guide louver will be kept immediately.



- Under swing up and down mode, when the status is switched from off to , if press this button again 2s later,  status will switch to off status directly; if press this button again within 2s, the change of swing status will also depend on the circulation sequence stated above.

## 8. Humidity button

Under cooling mode, press this button can select humidity control with cooling mode, smart dehumidification with cooling mode, and general cooling mode, and they can be set to operate circularly.

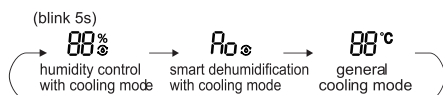

- When humidity control with cooling mode is set, the remote controller will display "  ", and humidity value "88" and "%" icon will blink for 5s; you can press " + " and " - " buttons to set the humidity value within 5s.

Under humidity control with cooling mode, humidity setting range for the remote controller: 40%~80%.

Temperature can be adjusted under humidity control with cooling mode.

- When smart dehumidification with cooling mode is set, the remote controller will display "  "; the remote controller and indoor unit will display "Ao" for 5 seconds.

Temperature can be adjusted under smart dehumidification with cooling mode.

- The humidity for smart dehumidification is automatically adjusted according to human body comfort; no need to set the humidity manually.

Under dry mode, press this button can select humidity control with dehumidification mode, continuous dehumidification mode, general dehumidification mode, and they can be set to operate circularly.



- When humidity control with dehumidification mode is set, the remote controller will display "  ", "%" and humidity value "88"; you can press " + " and " - " buttons to set the humidity value.

Humidity setting range for the remote controller: 30%~70%.

Temperature can't be adjusted under humidity control with dehumidification mode.

- When continuous dehumidification is set, the remote controller will display "  "; the remote controller and indoor unit will display "Co".

Temperature can't be adjusted under continuous dehumidification mode.

- Under continuous dehumidification mode, the unit always works under dehumidification status; no need to set temperature and humidity.

### NOTE:

• The air conditioner is mainly used for controlling the temperature, while the humidity control is the auxiliary function. The humidity will be affected by the factors such as indoor and outdoor environment, degree of indoor sealing and indoor flow.

- When the set humidity is higher than current atmospheric humidity, the set humidity can't be reached.
- If the humidity sensor is with malfunction, humidity setting under cooling mode or dehumidification mode will stop and the unit operates under general cooling mode or dehumidification mode.

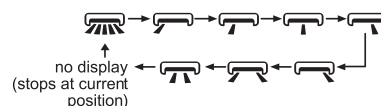

## 9. LR-swing button

Press this button can select left & right swing angle. Fan blow angle can be selected circularly as below:



### NOTE:

• Press this button continuously more than 2s, the main unit will swing back and forth from left to right, and then loosen the button, the unit will stop swinging and present position of guide louver will be kept immediately.

• Under swing left and right mode, when the status is switched from off to , if press this button again 2s later,  status will switch to off status directly; if press this button again within 2s, the change of swing status will also depend on the circulation sequence stated above.

- This function only applicable for some models.

## 10. Timer button

• At ON status, press this button once can set TIMER OFF. The character of HOUR and OFF will flash. Press " + " or " - " button within 5s can adjust the time of TIMER ON. After each pressing of " + " or " - " button, time will increase or decrease half an hour. When holding " + " or " - " button, 2s later, the time will change quickly until to reach to your required time. After that, press "Timer" button to confirm it. The character of HOUR and OFF won't flash again.

Cancel TIMER OFF: Press "Timer" button again under TIMER OFF status.

• At OFF status, press this button once can set TIMER ON. Please refer to TIMER off for detailed operation.





Cancel TIMER ON: Press "Timer" button again under TIMER ON status.

**NOTE:**

- Time setting range: 0.5~24 hours.
- Time interval between two operations can't exceed 5s. Otherwise, remote controller will exit the setting status automatically.

## 11. Sleep button

Press this button, can select Sleep 1 (  ), Sleep 2 (  ), Sleep 3 (  ) and cancel the Sleep, circulate between these, after electrified, Sleep Cancel is defaulted.

- Sleep 1 is Sleep mode 1, in Cool modes: sleep status after run for one hour, the main unit setting temperature will increase 1, two hours, setting temperature increased 2, then the unit will run at this setting temperature; In Heat mode: sleep status after run for one hour, the setting temperature will decrease 1, two hours, setting temperature will decrease 2, then the unit will run at this setting temperature.

- Sleep 2 is sleep mode 2, that is air conditioner will run according to the presetting a group of sleep temperature curve.

- Sleep 3 the sleep curve setting under Sleep mode by DIY;

(1) Under Sleep 3 mode, press "Health" button for a long time, remote controller enters into user individuation sleep setting status, at this time, the time of remote controller will display "1HOUR", the setting temperature "88" will display the corresponding temperature of last setting sleep curve and blink (The first entering will display according to the initial curve setting value of original factory);

(2) Adjust " + " and " - " button, could change the corresponding setting temperature, after adjusted, press "Health" button for confirmation;

(3) At this time, 1hour will be automatically increased at the timer position on the remote control, (that are "2HOUR" or "3HOUR" or "8HOUR"), the place of setting temperature "88" will display the corresponding temperature of last setting sleep curve and blink;

(4) Repeat the above step (2)~(3) operation, until 8 hours temperature setting finished, sleep, curve setting finished, at this time, the remote controller will resume the original timer display; temperature display will resume to original setting temperature.

- Sleep 3 the sleep curve setting under Sleep mode by DIY could be inquired:

The user could accord to sleep curve setting method to inquire the presetting sleep curve, enter into user individuation sleep setting status, but do not change the temperature, press "Health" button directly for confirmation. Note: In the above presetting or enquiry procedure, if continuously within 10s, there is no button pressed,

the sleep curve setting within 10s, there is no button pressed, the sleep curve setting status will be automatically quit and resume to display the original displaying. In the presetting or enquiry procedure, press " On/Off " button, "Mode" button, "Timer" button or "Sleep" button, the sleep curve setting or enquiry status will quit similarly.

## 12. Light button

Press this button to control the LED status on the displayer, the circulation change is as follow:

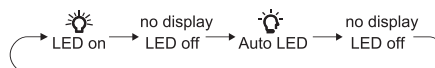

When selecting "  " (Auto LED) with remote controller, LED indicator on indoor unit will adjust the luminance automatically according to the ambient intensity of illumination.

## Function introduction for combination buttons



### Energy-saving function

Under cooling mode, press "Mode" and "Timer" buttons simultaneously to start up or turn off energy-saving function. When energy-saving function is started up, "SE" will be shown on remote controller, and air conditioner will adjust the set temperature automatically according to ex-factory setting to reach to the best energy-saving effect. Press "Mode" and "Timer" buttons simultaneously again to exit energy-saving function.

**NOTE:**

- Under energy-saving function, fan speed is defaulted at auto speed and it can't be adjusted.
- Under energy-saving function, set temperature can't be adjusted.
- Sleep function and energy-saving function can't operate at the same time. If energy-saving function has been set under cool mode, press "Sleep" button will cancel energy-saving function. If sleep function has been set under cool mode, start up the energy-saving function will cancel sleep function.

### Child lock function

Hold " On/Off " and " - " buttons simultaneously for 3s to turn on or turn off child lock function. When child lock function is on, "  " icon is displayed on remote controller. If you operate the remote controller, the "  " icon will blink three times without sending signal to the unit.

### Temperature display switchover function

Under OFF status, hold "Mode" and " - " buttons simultaneously for 3s to switch temperature display between °C and °F.



this time, status of indoor unit and the display status on the remote controller may be different.

- This function is only available for some models.

### Auto clean function

Under unit off status, hold "Mode" and " " buttons simultaneously for 5s to turn on or turn off the auto clean function. When the auto clean function is turned on, indoor unit displays "CL". During the auto clean process of evaporator, the unit will perform fast cooling or fast heating. There may be some noise, which is the sound of flowing liquid or thermal expansion or cold shrinkage. The air conditioner may blow cool or warm air, which is a normal phenomenon. During cleaning process, please make sure the room is well ventilated to avoid affecting the comfort.

#### NOTE:

- The auto clean function can only work under normal ambient temperature. If the room is dusty, clean it once a month; if not, clean it once every three months. After the auto clean function is turned on, you can leave the room. When auto clean is finished, the air conditioner will enter standby status.
- This function is only available for some models.

### Night mode

Under cooling or heating mode, when turning on sleep mode and turn to low speed or quiet notch, the outdoor unit would enter into night mode.

#### NOTE:

- When you feel that the cooling and heating effect is poor, please press "Fan" button to other fan speed or press "Sleep" button to exit the night mode.
- The night mode can only work under normal ambient temperature.
- This function is only available for some models.

### I FEEL function

Press "Health" and " + " buttons simultaneously to start I FEEL function and " " will be displayed on the remote controller. After this function is set, the remote controller will send the detected ambient temperature to the controller and the unit will automatically adjust the indoor temperature according to the detected temperature. Press "Health" and " + " buttons simultaneously again to turn off I FEEL function and " " will disappear.

- Please put the remote controller near user when this function is set. Do not put the remote controller near the object of high

temperature or low temperature in order to avoid detecting inaccurate ambient temperature. When I FEEL function is turned on, the remote controller should be put within the area where indoor unit can receive the signal sent by the remote controller.

### Two-way ventilation function

Under turning on, press "Mode" and "Health" buttons simultaneously to start up or turn off two-way ventilation function. When two-way ventilation function is started up, will be shown on remote controller, and the light of the two-way ventilation system is turned on. Fan speed will be adjusted according to the fan speed of air conditioner.

Under turning off, press "Mode" and "Health" buttons simultaneously to start up or turn off two-way ventilation function only. When two-way ventilation function is started up, will be shown on remote controller, and the light of the two-way ventilation system is turned on. Fan speed will be adjusted according to fan button on remote controller.

### Replacement of batteries in remote controller

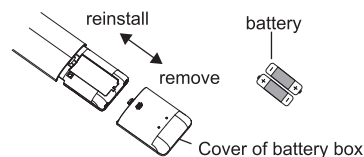

1. Press the back side of remote controller marked with " ", as shown in the fig, and then push out the cover of battery box along the arrow direction.

2. Replace two 7# (AAA 1.5V) dry batteries, and make sure the position of " + " polar and " - " polar are correct.

3. Reinstall the cover of battery box.

#### NOTE:

- During operation, point the remote control signal sender at the receiving window on indoor unit.
- The distance between signal sender and receiving window should be no more than 8m, and there should be no obstacles between them.
- Signal may be interfered easily in the room where there is fluorescent lamp or wireless telephone; remote controller should be close to indoor unit during operation.
- Replace new batteries of the same model when replacement is required.
- When you don't use remote controller for a long time, please take out the batteries.
- If the display on remote controller is fuzzy or there's no display, please replace batteries.





- Set temperature range from remote controller: 16~30°C (61~86°F).
- This mode indicator is not available for some models.
- Cooling only unit won't receive heat mode signal. If setting heat mode with remote controller, press "On/Off" button can't start up the unit.

### 3. Fan button

This button is used for setting Fan Speed in the sequence that goes from AUTO, , , , , , to then back to Auto.

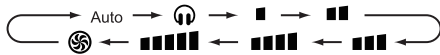

- Low speed
- Low-Medium speed
- Medium speed
- Medium-High speed
- High speed
- Turbo speed
- Quiet speed

#### NOTE:

- It's low fan speed under dry mode.
- X-FAN function: Holding fan speed button for 2s in cool or dry mode, the icon is displayed and the indoor fan will continue operation for a few minutes in order to dry the indoor unit even though you have turned off the unit. After energization, X-FAN OFF is defaulted. X-FAN is not available in auto, fan or heat mode.

This function indicates that moisture on evaporator of indoor unit will be blown after the unit is stopped to avoid mould.

- Having set X-FAN function on: After turning off the unit by pressing "On/Off" button, indoor fan will continue running for a few minutes at low speed. In this period, hold fan speed button for 2s to stop indoor fan directly.
- Having set X-FAN function off: After turning off the unit by pressing "On/Off" button, the complete unit will be off directly.

### 4. - / + button

Press " + " or " - " button once increase or decrease set temperature 1°C(°F). Holding " + " or " - " button, 2s later, set temperature on remote controller will change quickly. On releasing button after setting is finished, temperature indicator on indoor unit will change accordingly.

### 5. Wifi button

Press "Wifi" button to turn on WiFi function, "Wifi" icon will be displayed on the remote controller; Hold "Wifi" button for 5s to turn off WiFi function and "Wifi" icon will disappear. Under off status, press "Mode" and "Wifi" buttons simultaneously for 1s, WiFi module will restore factory settings.

#### NOTE:

- This function is only available for some models.

### 6. Health button

Press this button to turn on or turn off the health function and UVC lamp in operation status.



- When selecting " " with remote controller, Cold Plasma will be turn on.
- When selecting " " with remote controller, UVC lamp will be turn on.
- When selecting " " with remote controller, Cold Plasma and UVC lamp will be turn on together.

#### NOTE:

- Health function and UVC lamp are only available for some models.

### 7. UD-swing button

Press this button can select up & down swing angle. Fan blow angle can be selected circularly as below:

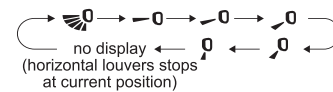

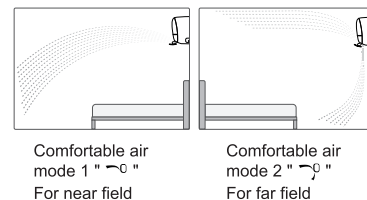

- When selecting " ", air conditioner is blowing fan automatically. Horizontal louver will automatically swing up & down at maximum angle.
- When selecting " , , , , ", air conditioner is blowing fan at fixed position. Horizontal louver will stop at the fixed position.
- Hold " " button above 2s to set your required swing angle. When reaching your required angle, release the button.
- Under cooling, press this button to set comfortable air mode 1 " " and comfortable air mode 2 " ". The recommended applicable scenes of comfortable air modes are as follows:



#### NOTE:

- Press this button continuously more than 2s, the main unit will swing back and forth from up to down, and then loosen the button, the unit will stop swinging and present position of guide louver will be kept immediately.

- Under swing up and down mode, when the status is switched from off to , if press this button again 2s later,  status will switch to off status directly; if press this button again within 2s, the change of swing status will also depend on the circulation sequence stated above.

## 8. Humidity button

Under cooling mode, press this button can select humidity control with cooling mode, smart dehumidification with cooling mode, and general cooling mode, and they can be set to operate circularly.

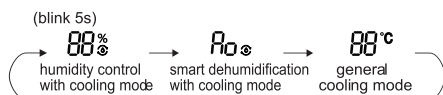

- When humidity control with cooling mode is set, the remote controller will display "  ", and humidity value "88" and "%" icon will blink for 5s; you can press " + " and " - " buttons to set the humidity value within 5s.

Under humidity control with cooling mode, humidity setting range for the remote controller: 40%~80%.

Temperature can be adjusted under humidity control with cooling mode.

- When smart dehumidification with cooling mode is set, the remote controller will display "  "; the remote controller and indoor unit will display "Ao" for 5 seconds.

Temperature can be adjusted under smart dehumidification with cooling mode.

- The humidity for smart dehumidification is automatically adjusted according to human body comfort; no need to set the humidity manually.

Under dry mode, press this button can select humidity control with dehumidification mode, continuous dehumidification mode, general dehumidification mode, and they can be set to operate circularly.



- When humidity control with dehumidification mode is set, the remote controller will display "  ", "%" and humidity value "88"; you can press " + " and " - " buttons to set the humidity value.

Humidity setting range for the remote controller: 30%~70%.

Temperature can't be adjusted under humidity control with dehumidification mode.

- When continuous dehumidification is set, the remote controller will display "  "; the remote controller and indoor unit will display "Co".

Temperature can't be adjusted under continuous dehumidification mode.

- Under continuous dehumidification mode, the unit always works under dehumidification status; no need to set temperature and humidity.

### NOTE:

• The air conditioner is mainly used for controlling the temperature, while the humidity control is the auxiliary function. The humidity will be affected by the factors such as indoor and outdoor environment, degree of indoor sealing and indoor flow.

- When the set humidity is higher than current atmospheric humidity, the set humidity can't be reached.
- If the humidity sensor is with malfunction, humidity setting under cooling mode or dehumidification mode will stop and the unit operates under general cooling mode or dehumidification mode.

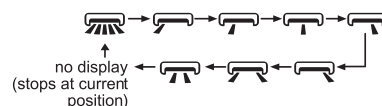

## 9. LR-swing button

Press this button can select left & right swing angle. Fan blow angle can be selected circularly as below:



### NOTE:

• Press this button continuously more than 2s, the main unit will swing back and forth from left to right, and then loosen the button, the unit will stop swinging and present position of guide louver will be kept immediately.

- Under swing left and right mode, when the status is switched from off to , if press this button again 2s later,  status will switch to off status directly; if press this button again within 2s, the change of swing status will also depend on the circulation sequence stated above.

- This function only applicable for some models.

## 10. Timer button

• At ON status, press this button once can set TIMER OFF. The character of HOUR and OFF will flash. Press " + " or " - " button within 5s can adjust the time of TIMER ON. After each pressing of " + " or " - " button, time will increase or decrease half an hour. When holding " + " or " - " button, 2s later, the time will change quickly until to reach to your required time. After that, press "Timer" button to confirm it. The character of HOUR and OFF won't flash again.

Cancel TIMER OFF: Press "Timer" button again under TIMER OFF status.



- At OFF status, press this button once can set TIMER ON. Please refer to TIMER off for detailed operation.

Cancel TIMER ON: Press "Timer" button again under TIMER ON status.

**NOTE:**

- Time setting range: 0.5~24 hours.
- Time interval between two operations can't exceed 5s. Otherwise, remote controller will exit the setting status automatically.

**11.  Sleep button**

Press this button, can select Sleep 1 (  ), Sleep 2 (  ), Sleep 3 (  ) and cancel the Sleep, circulate between these, after electrified, Sleep Cancel is defaulted.

- Sleep 1 is Sleep mode 1, in Cool modes: sleep status after run for one hour, the main unit setting temperature will increase 1, two hours, setting temperature increased 2, then the unit will run at this setting temperature; In Heat mode: sleep status after run for one hour, the setting temperature will decrease 1, two hours, setting temperature will decrease 2, then the unit will run at this setting temperature.

- Sleep 2 is sleep mode 2, that is air conditioner will run according to the presetting a group of sleep temperature curve.

- Sleep 3 the sleep curve setting under Sleep mode by DIY;

(1) Under Sleep 3 mode, press "Health" button for a long time, remote controller enters into user individuation sleep setting status, at this time, the time of remote controller will display "1HOUR", the setting temperature "88" will display the corresponding temperature of last setting sleep curve and blink (The first entering will display according to the initial curve setting value of original factory);

(2) Adjust " + " and " - " button, could change the corresponding setting temperature, after adjusted, press "Health" button for confirmation;

(3) At this time, 1hour will be automatically increased at the timer position on the remote control, (that are "2HOUR" or "3HOUR" or "8HOUR"), the place of setting temperature "88" will display the corresponding temperature of last setting sleep curve and blink;

(4) Repeat the above step (2)~(3) operation, until 8 hours temperature setting finished, sleep, curve setting finished, at this time, the remote controller will resume the original timer display; temperature display will resume to original setting temperature.

- Sleep 3 the sleep curve setting under Sleep mode by DIY could be inquired:

The user could accord to sleep curve setting method to inquire the presetting sleep curve, enter into user individuation sleep setting status, but do not change the temperature, press "Health" button directly for confirmation. Note: In the above presetting or enquiry procedure, if continuously within 10s, there is no button pressed,

the sleep curve setting within 10s, there is no button pressed, the sleep curve setting status will be automatically quit and resume to display the original displaying. In the presetting or enquiry procedure, press " On/Off " button, "Mode" button, "Timer" button or "Sleep" button, the sleep curve setting or enquiry status will quit similarly.

**12.  Light button**

Press this button to control the LED status on the displayer, the circulation change is as follow:

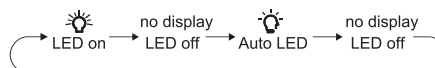

When selecting "  " (Auto LED) with remote controller, LED indicator on indoor unit will adjust the luminance automatically according to the ambient intensity of illumination.

**Function introduction for combination buttons**



**Energy-saving function**

Under cooling mode, press "Mode" and "Timer" buttons simultaneously to start up or turn off energy-saving function. When energy-saving function is started up, "SE" will be shown on remote controller, and air conditioner will adjust the set temperature automatically according to ex-factory setting to reach to the best energy-saving effect. Press "Mode" and "Timer" buttons simultaneously again to exit energy-saving function.

**NOTE:**

- Under energy-saving function, fan speed is defaulted at auto speed and it can't be adjusted.
- Under energy-saving function, set temperature can't be adjusted.
- Sleep function and energy-saving function can't operate at the same time. If energy-saving function has been set under cool mode, press "Sleep" button will cancel energy-saving function. If sleep function has been set under cool mode, start up the energy-saving function will cancel sleep function.

**Child lock function**

Hold " On/Off " and " - " buttons simultaneously for 3s to turn on or turn off child lock function. When child lock function is on, "  " icon is displayed on remote controller. If you operate the remote controller, the "  " icon will blink three times without sending signal to the unit.

**Temperature display switchover function**

Under OFF status, hold "Mode" and " - " buttons simultaneously for 3s to switch temperature display between °C and °F.

## ⏸ function

⏸ function is for limiting power of the whole unit. Press "Mode" and "Sleep" buttons simultaneously, the remote controller will circularly display as the following:

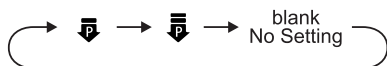

- Maximum power limited under the ⏸ mode is lower than that of ⏸ mode.
- If you want to cancel the power limiting function, press "Mode" and "Sleep" buttons simultaneously till the icon in remote controller is not displayed.
- When the remote controller is turned off, power limiting function is cancelled. If you want to activate the function, please repress "Mode" and "Sleep" buttons simultaneously.
- If the current power is lower than the maximum power of mode, then the power will not be limited after entering into such mode.
- For the model with one outdoor unit and two indoor units, if any one of indoor units enters into power limiting function, the outdoor unit will enter into the set limiting power mode of indoor unit; when two indoor units enter into power limiting mode, then the power of outdoor unit will be limited according to the lower power of the two indoor units.

### NOTE:

- This button is only available for the model with such function.

## Indoor ambient temperature or humidity display

By holding "On/Off" and "⏸" buttons simultaneously, you can see indoor ambient temperature or indoor ambient humidity on indoor unit's display. The setting on remote controller is selected circularly as below:



- When selecting "🌡" with remote controller, temperature indicator on indoor unit displays indoor ambient temperature.
- When selecting "💧" with remote controller, temperature indicator on indoor unit displays indoor ambient humidity.

### NOTE:

- The ambient humidity value is only for reference. E.g.: If humidity value is "0%", there may be malfunction for the humidity detection board. Please contact local service provider.
- There may be some measuring deviation for humidity detection and photosensitiveness detection.

## Clean reminder function of filter

The reminder function is defaulted to be OFF. Hold "On/Off" and "⏸" buttons simultaneously for 5s to turn it on. The buzzer will give out sound for 0.5s and the dual-8 nixie tube on the display will be on for 3s; Once the reminder function is turned on, when the air conditioner has reached to the set time, the dual-8 nixie tube will flash about 30s when the unit is turned on each time to remind the user to clean the filter; you can turn off this cycle reminder by holding "On/Off" and "⏸" buttons simultaneously for 5s and then the air conditioner will count time again.

### NOTE:

- Once the reminder function is turned on, only this cycle reminder can be cleared.
- This function is only available for some models.

## Volume control of IDU Buzzer

Press "Mode" and "🔊" buttons simultaneously to reduce the sound level of the indoor unit' buzzer.

### NOTE:

- This function is only available for some models.

## Fast cool function

Press "On/Off" and "+" buttons simultaneously under cooling mode can select 25°C(77°F) fast cooling mode, 16°C(61°F) fast cooling mode and normal cooling mode circularly. "⊗" icon will be displayed on the remote controller under fast cooling mode.

Once it enters into fast cooling mode, the fan speed is auto fan and the set temperature is 25°C(77°F) or 16°C(61°F). At this time, the set temperature flashes to display for 5s. In the flashing period, press "+" or "-" button to adjust the set temperature.

Press "Fan" button to adjust the fan speed. If the set temperature and the fan speed haven't been adjusted during that time, the remote controller and the indoor unit will operate under current set temperature and fan speed for 20 minutes. 20 minutes later, the set temperature and the fan speed for the remote controller and the indoor unit will turn to the status before quick cooling.

### NOTE:

- If the set temperature and the fan speed have been adjusted during the operation under fast cooling mode, the unit will exit from the fast cooling mode. Then the indoor unit operates continuously under the adjusted status.
- Fast cooling function is only applicable for some models. If this function is unavailable for this indoor unit, 20 minutes later, the remote controller will turn back to the status before fast cooling. Indoor unit operates continuously according to current status. At



this time, status of indoor unit and the display status on the remote controller may be different.

- This function is only available for some models.

### Auto clean function

Under unit off status, hold "Mode" and " " buttons simultaneously for 5s to turn on or turn off the auto clean function. When the auto clean function is turned on, indoor unit displays "CL". During the auto clean process of evaporator, the unit will perform fast cooling or fast heating. There may be some noise, which is the sound of flowing liquid or thermal expansion or cold shrinkage. The air conditioner may blow cool or warm air, which is a normal phenomenon. During cleaning process, please make sure the room is well ventilated to avoid affecting the comfort.

#### NOTE:

- The auto clean function can only work under normal ambient temperature. If the room is dusty, clean it once a month; if not, clean it once every three months. After the auto clean function is turned on, you can leave the room. When auto clean is finished, the air conditioner will enter standby status.
- This function is only available for some models.

### Night mode

Under cooling or heating mode, when turning on sleep mode and turn to low speed or quiet notch, the outdoor unit would enter into night mode.

#### NOTE:

- When you feel that the cooling and heating effect is poor, please press "Fan" button to other fan speed or press "Sleep" button to exit the night mode.
- The night mode can only work under normal ambient temperature.
- This function is only available for some models.

### I FEEL function

Press "Health" and " + " buttons simultaneously to start I FEEL function and " " will be displayed on the remote controller. After this function is set, the remote controller will send the detected ambient temperature to the controller and the unit will automatically adjust the indoor temperature according to the detected temperature. Press "Health" and " + " buttons simultaneously again to turn off I FEEL function and " " will disappear.

- Please put the remote controller near user when this function is set. Do not put the remote controller near the object of high

temperature or low temperature in order to avoid detecting inaccurate ambient temperature. When I FEEL function is turned on, the remote controller should be put within the area where indoor unit can receive the signal sent by the remote controller.

### Two-way ventilation function

Under turning on, press "Mode" and "Health" buttons simultaneously to start up or turn off two-way ventilation function. When two-way ventilation function is started up, will be shown on remote controller, and the light of the two-way ventilation system is turned on. Fan speed will be adjusted according to the fan speed of air conditioner.

Under turning off, press "Mode" and "Health" buttons simultaneously to start up or turn off two-way ventilation function only. When two-way ventilation function is started up, will be shown on remote controller, and the light of the two-way ventilation system is turned on. Fan speed will be adjusted according to fan button on remote controller.

### Replacement of batteries in remote controller

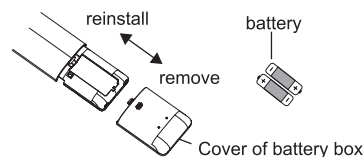

1. Press the back side of remote controller marked with " ", as shown in the fig, and then push out the cover of battery box along the arrow direction.
2. Replace two 7# (AAA 1.5V) dry batteries, and make sure the position of " + " polar and " - " polar are correct.
3. Reinstall the cover of battery box.

#### NOTE:

- During operation, point the remote control signal sender at the receiving window on indoor unit.
- The distance between signal sender and receiving window should be no more than 8m, and there should be no obstacles between them.
- Signal may be interfered easily in the room where there is fluorescent lamp or wireless telephone; remote controller should be close to indoor unit during operation.
- Replace new batteries of the same model when replacement is required.
- When you don't use remote controller for a long time, please take out the batteries.
- If the display on remote controller is fuzzy or there's no display, please replace batteries.

## 6.3 Brief Description of Models and Functions

### • Indoor Unit

#### 1. Basic function of system

##### (1) Cooling mode

(1) Under this mode, fan and swing operates at setting status. Temperature setting range is 16~30°C.

(2) During malfunction of outdoor unit or the unit is stopped because of protection, indoor unit keeps original operation status.

##### (2) Drying mode

(1) Under this mode, fan operates at low speed and swing operates at setting status. Temperature setting range is 16~30°C.

(2) During malfunction of outdoor unit or the unit is stopped because of protection, indoor unit keeps original operation status.

(3) Protection status is same as that under cooling mode.

(4) Sleep function is not available for drying mode.

##### (3) Heating mode

(1) Under this mode, Temperature setting range is 16~30°C.

(2) Working condition and process for heating mode:

When turn on the unit under heating mode, indoor unit enters into cold air prevention status. When the unit is stopped or at OFF status, and indoor unit has been started up just now, the unit enters into residual heat-blowing status.

##### (4) Working method for AUTO mode:

1. Working condition and process for AUTO mode:

a. Under AUTO mode, standard heating  $T_{\text{preset}}=20^{\circ}\text{C}$  and standard cooling  $T_{\text{preset}}=25^{\circ}\text{C}$ . The unit will switch mode automatically according to ambient temperature.

2. Protection function

a. During cooling operation, protection function is same as that under cooling mode.

b. During heating operation, protection function is same as that under heating mode.

3. Display: Set temperature is the set value under each condition. Ambient temperature is  $(T_{\text{amb.}}-T_{\text{compensation}})$  for heat pump unit and  $T_{\text{amb.}}$  for cooling only unit.

4. If there's I feel function,  $T_{\text{compensation}}$  is 0. Others are same as above.

##### (5) Fan mode

Under this mode, indoor fan operates at set fan speed. Compressor, outdoor fan, 4-way valve and electric heating tube stop operation. Indoor fan can select to operate at high, medium, low or auto fan speed. Temperature setting range is 16~30°C.

#### 2. Other control

##### (1) Buzzer

Upon energization or availablely operating the unit or remote controller, the buzzer will give out a beep.

##### (2) Auto button

If press this auto button when turning off the unit, the complete unit

will operate at auto mode. Indoor fan operates at auto fan speed and swing function is turned on. Press this auto button at ON status to turn off the unit.

##### (3) Auto fan

Heating mode: During auto heating mode or normal heating mode, auto fan speed will adjust the fan speed automatically according to ambient temperature and set temperature.

##### (4) Sleep

After setting sleep function for a period of time, system will adjust set temperature automatically.

##### (5) Timer function:

General timer and clock timer functions are compatible by equipping remote controller with different functions.

##### (6) Memory function

memorize compensation temperature, off-peak energization value.

Memory content: mode, up & down swing, light, set temperature, set fan speed, general timer (clock timer can't be memorized).

After power recovery, the unit will be turned on automatically according to memory content.

##### (7) Health function

During operation of indoor fan, set health function by remote controller. Turn off the unit will also turn off health function.

Turn on the unit by pressing auto button, and the health is defaulted ON.

Once compressor is started, it won't stop within 6 mins according to the change of room temp.

##### 1) Auto mode

① Operation condition and process for auto mode

Under auto mode, the system will automatically select operation mode (cooling, heating, and fan) according to indoor ambient temperature. There will be 30s delayed for protection between mode switchover.

◆ When  $T_{\text{amb.}} \geq 26^{\circ}\text{C}$ , unit will be in cooling mode. Ex-factory set temperature is  $25^{\circ}\text{C}$

◆ Cooling and heating unit: When  $T_{\text{amb.}} \leq (19^{\circ}\text{C} + T_{\text{compensation}})$ , unit will be in heating mode  $T_{\text{preset}}=20^{\circ}\text{C}$ .

◆ Cooling only unit: When  $T_{\text{amb.}} \leq 22^{\circ}\text{C}$  (or  $72^{\circ}\text{F}$ ), unit will be in fan mode  $T_{\text{preset}}=25^{\circ}\text{C}$ .

◆ For cooling and heating unit under condition that  $(19^{\circ}\text{C} + T_{\text{compensation}}) < T_{\text{amb.}} < 26^{\circ}\text{C}$  (For cooling only unit under condition that  $22^{\circ}\text{C} < T_{\text{amb.}} < 26^{\circ}\text{C}$ ), when unit is initially turned on in auto mode, it will operate according to auto fan mode. When unit is changed to auto mode from other modes, it will maintain its previous working status (If auto mode is turned on from drying mode, unit will operate according to auto fan mode).

② Protection function is same as that under each mode.

##### 2) Cooling mode

① Operation condition and process for cooling mode

◆ When  $T_{\text{amb.}} \geq T_{\text{set}} + 1^{\circ}\text{C}$ , the system operates under cooling mode.

In this case, the compressor, the ODU fan motor and the IDU fan motor operates at set speed.

◆ When  $T_{amb.} \leq T_{set} - 1^{\circ}\text{C}$ , the compressor and the ODU fan motor stop, while the IDU fan motor operates at set speed.

◆ When  $T_{set} - 1^{\circ}\text{C} < T_{amb.} < T_{set} + 1^{\circ}\text{C}$ , the system will maintain its previous operation status.

In cooling mode, the 4-way valve is de-energized (4-way valve is not available for cooling only unit). Temperature setting range is 16~30°C.

### (8) I feel control mode

After controller received I feel control signal and ambient temperature sent by remote controller, controller will work according to the ambient temperature sent by remote controller.

### (9) Entry condition for compulsory defrosting function

When turn on the unit under heating mode and set temperature is 16°C (or 16.5°C by remote controller), press “ $\Delta$ ,  $\nabla$ ,  $\Delta$ ,  $\nabla$ ,  $\Delta$ ,  $\nabla$ ” (or +, -, +, -, +, -, -) button successively within 5s and then indoor unit will enter into compulsory defrosting setting status:

(1) If there's only indoor units controller, it enters into indoor normal defrosting mode.

(2) If there's indoor units controller and outdoor units controller, indoor unit will send compulsory defrosting mode signal to outdoor unit and then outdoor unit will operate under normal defrosting mode. After indoor unit received the signal that outdoor unit has entered into defrosting status, indoor unit will cancel to send compulsory mode to outdoor unit. If outdoor unit hasn't received feedback signal from outdoor unit after 3min, indoor unit will also cancel to send compulsory defrosting signal.

### (10) Refrigerant recovery function:

Enter into Freon recovery mode actively: Within 5min after energization, turn on the unit at 16°C under cooling mode, and press light button for 3 times within 3s to enter into Freon recovery mode. Fo is displayed and Freon recovery mode will be sent to outdoor unit.

### (11) Ambient temperature display control mode

1. When user set the remote controller to display set temperature (corresponding remote control code: 01), current set temperature will be displayed.

2. Only when remote control signal is switched to indoor ambient temperature display status (corresponding remote control code: 10) from other display status (corresponding remote control code: 00, 01, 11), controller will display indoor ambient temperature for 3s and then turn back to display set temperature.

Under this mode, indoor fan operates at set fan speed. Compressor, outdoor fan, 4-way valve and electric heating tube stop operation. Indoor fan can select to operate at high, medium, low or auto fan speed. Temperature setting range is 16~30°C.

### (12) Off-peak energization function:

Adjust compressors minimum stop time. The original minimum stop time is 180s and then we change to:

The time interval between two start-ups of compressor can't be

less than  $180 + T_s (0 \leq T \leq 15)$ . T is the variable of controller. That's to say the minimum stop time of compressor is 180s~195s. Read-in T into memory chip when refurbish the memory chip each time. After power recovery, compressor can only be started up after  $180 + T$  s at least.

### (13) SE control mode

The unit operates at SE status.

### (14) X-fan mode

When X-fan function is turned on, after turn off the unit, indoor fan will still operate at low speed for a few minutes and then the complete unit will be turned off. When x-fan function is turned off, after turn off the unit, the complete unit will be turned off directly.

### (15) 8°C heating function

Under heating mode, you can set 8°C heating function by remote controller. The system will operate at 8°C set temperature.

### (16) Turbo function

Turbo function can be set under cooling and heating modes. Press Fan Speed button to cancel turbo setting. Turbo function is not available under auto, drying and fan modes.

## • Outdoor Unit

### 1. Basic Functions

#### (1) Cooling Mode

1. Conditions and processes of cooling operation:

(1) If the compressor is shut down, and  $[T_{setup} - (T_{indoor\ ambient\ temperature} - \Delta T_{cooling\ indoor\ ambient\ temperature\ compensation})] < 0^{\circ}\text{C}$ , start up the machine for cooling, the cooling operation will start;

(2) During operations of cooling, if  $0^{\circ}\text{C} \leq [T_{setup} - (T_{indoor\ ambient\ temperature} - \Delta T_{cooling\ indoor\ ambient\ temperature\ compensation})] < 2^{\circ}\text{C}$ , the cooling operation will be still running;

(3) During operations of cooling, if  $2^{\circ}\text{C} \leq [T_{setup} - (T_{indoor\ ambient\ temperature} - \Delta T_{cooling\ indoor\ ambient\ temperature\ compensation})]$ , the cooling operation will stop after reaching the temperature point.

2. Temperature setting range

(1) If  $T_{outdoor\ ambient\ temperature} \geq [T_{low\ temperature\ cooling\ temperature}]$ , the temperature can be set at: 16~30°C (Cooling at room temperature);

(2) If  $T_{outdoor\ ambient\ temperature} < [T_{low\ temperature\ cooling\ temperature}]$ , the temperature can be set at: 25~30°C (Cooling at low temperature), that is, the minimum setting temperature for outer units judgment is 25°C.

#### (2) Dehumidifying Mode

1. Conditions and processes of dehumidifying operations: Same as the cooling mode;

2. The temperature setting range is: 16~30°C;

#### (3) Air-supplying Mode

1. The compressor, outdoor fans and four-way valves are switched off;

2. The temperature setting range is: 16~30°C.

#### (4) Heating Mode

1. Conditions and processes of heating operations:

( $T_{indoor\ ambient\ temperature}$  is the actual detection temperature of indoor

environment thermo-bulb,  $T_{\text{heating indoor ambient temperature compensation}}$  is the indoor ambient temperature compensation during heating operations)

(1) If the compressor is shut down, and  $[(T_{\text{indoor ambient temperature}} - \triangle T_{\text{heating indoor ambient temperature compensation}}) - T_{\text{setup}}] < 0^{\circ}\text{C}$ , start the machine to enter into heating operations for heating;

(2) During operations of heating, if  $0^{\circ}\text{C} \leq [(T_{\text{indoor ambient temperature}} - \triangle T_{\text{heating indoor ambient temperature compensation}}) - T_{\text{setup}}] < 2^{\circ}\text{C}$ , the heating operation will be still running;

(3) During operations of heating, if  $2^{\circ}\text{C} \leq [(T_{\text{indoor ambient temperature}} - \triangle T_{\text{heating indoor ambient temperature compensation}}) - T_{\text{setup}}]$ , the heating operation will stop after reaching the temperature point.

2. The temperature setting range in this mode is: 16~30°C .

### 3. Special Functions

#### Defrosting Control

① Conditions for starting defrosting

After the time for defrosting is judged to be satisfied, if the temperature for defrosting is satisfied after detections for continuous 3minutes, the defrosting operation will start.

② Conditions of finishing defrosting

The defrosting operation can exit when any of the conditions below is satisfied:

③  $T_{\text{outdoor pipe temperature}} \geq (T_{\text{outdoor ambient temperature}} - [T_{\text{temperature 1 of finishing defrosting}}])$ ;

④ The continuous running time of defrosting reaches  $[t_{\text{max. defrosting time}}]$ .

#### 4. Control Logic

##### (1) Compressor Control

Start the compressor after starting cooling, heating, dehumidifying operations, and the outer fans start for 5s; When the machine is shutdown, in safety stops and when switching to air-supplying mode, the compressor will stop immediately. In all modes: once the compressor starts up, it will not be allowed to stop until having run for the  $[t_{\text{min. compressor running time}}]$  (Note: including cases of shutdown when the temperature point is reached; except the cases requiring stopping the compressor such as fault protection, remote shutdown, mode switching etc.); In all modes: once the compressor stops, it will be allowed be restart after 3-minute delay (Note: The indoor units have a function of power memory, the machine can be restarted after remote shutdown and powering up again without delay).

1. Cooling mode

Start the machine to enter into cooling operation for cooling, the compressor is switched on.

2. Dehumidifying mode

Same as the cooling mode.

3. Air-supplying mode

The compressor is switched off.

4. Heating mode

(1) Start the machine to enter into heating operation for heating, the compressor is switched on.

(2) Defrosting:

a. Defrosting starts: the compressor is shut down, and restarts it after 55-second delay.

b. Defrosting ends: the compressor stops, then starts it after 55-second delay.

##### (2) Outer Fans Control

Notes:

Only the outer fans run for at least 80s in each air flow speed can the air flow be switched;

After the outer fans run compulsively in high speed for 80s when the machine starts up, control the air flow according to the logic.

After remote shutdown, safety stops, and when the machine stops after reaching the temperature point, as well as after the compressor stops, extend 1 minute, the outer fans will stop (During the period in the 1 minute, the air flow of outer fans can be changed according to the outdoor ambient temperature changes); When running with force, the outdoor fans shall run in the highest air flow.

##### (3) 4-way valve control

1. The 4-way valve control under the modes of Cooling, dehumidification and supplying air: closing;

2. The status of 4-way valve control under the heating mode: getting power;

(1) 4-way valve power control under heating mode

a. Starts the machine under heating mode, the 4-way valve will get power immediately.

(2) 4-way valve power turn-off control under heating mode

a. When you should turn off the power or switch to other mode under heating mode, the power of 4-way valve will be cut after 2 minutes of the compressor stopped.

b. When all kinds of protection stops, the power of 4-way valve will be cut after delaying 4 minutes.

(3) Defrosting control under heating mode:

a. Defrosting begins: The power of 4-way valve will be cut after 50s of entering into the defrosting compressor.

b. Defrosting stops: The 4-way valve will get power after 50s of exiting the defrosting compressor.

##### (4) Evaporator frozen-preventing protection function

1. Starting estimation:

When the indoor unit is running 6 minutes (the compressor is turned on), the  $T_{\text{inner pipe}} \leq [T_{\text{frozen-preventing stop}}]$  (the temperature of hysteresis is 2 ) is detected in 3 minutes., then enter the frozen-preventing protection.

2. Frequency limited

When the indoor unit enters frozen-preventing protection, according to cooling reaches temperature point stop.

##### (5) Compressor overloads protection

If you measure the compressor overload switch action in 3s, the compressor should be stopped for overloading. The machine should be allowed to operate after overload protection was measured to resume. If the overloading protection continuously occurs for three times, it should not be resumed automatically, and



you should press the ON/OFF button to resume. The protection times of compressor is allowed to clear after the compressor run [t Protection times clearing of compressor overloading.] 30 minutes.

#### (6) Communication fault

When you have not received any correct signal from the inner machine in three minutes, the machine will stop for communication fault. When you have not received any correct signal from driver IC (aim to the controller for the separating of main control IC and driver IC), and the machine will stop for communication fault. If the communication is resumed, the machine will be allowed to operate.

#### (7) Module protection

Testing the module protective signal immediately after started, once the module protective signal is measured, stop the machine with module protection immediately. If the module protection is resumed, the machine will be allowed to operate. If the module protection continuously occurs for three times, it should not be resumed automatically, and you should press the ON/OFF button to resume. If the running time of compressor exceeds the [t Protection times clearing of module], the module protection is cleared to recount.

#### (9) Module overheating protection

##### 1. Starting estimation:

After the compressor stopped working for 180s, if  $T_{Module} < [T_{Module} \text{ frequency limited temperature}]$ , the machine is allowed to start, otherwise it should not be started, and should be stopped to treat according to the module overheating protection: The machine should be stopped or transferred to supply air, the trouble should be cleared immediately, and the protection times are not counted.

##### 2. Frequency limited

If  $[T_{Limited \text{ frequency temperature of module}}] \leq T_{Module} < [T_{frequency \text{ reducing temperature at normal speed of module}}]$ , you should limit the frequency raising of compressor.

##### 3. Reducing frequency at normal speed and power turn-off:

If  $[T_{frequency \text{ reducing temperature at normal speed of module}}] \leq T_{Module} < [T_{frequency \text{ reducing temperature at high speed of module}}]$ , you should adjust the compressor frequency by reducing 8Hz/90s till the lower limit; After it was running 90s at the lower limit, if  $[T_{frequency \text{ reducing temperature at normal speed of module}}] \leq T_{Module}$ , you should stop the machine for module overheating protection;

##### 4. Reducing frequency at high speed and power turn-off:

If  $[T_{frequency \text{ reducing temperature at high speed of module}}] \leq T_{Module} < [T_{Power \text{ turn-off temperature of module}}]$  you should adjust the compressor frequency by reducing 30Hz/90s till the lower limit; After it was running 90s at the lower limit, if  $[T_{frequency \text{ reducing temperature at normal speed of module}}] \leq T_{Module}$ , you should stop the machine for module overheating protection;

##### 5. Power turn-off:

If the  $[T_{Power \text{ turn-off temperature of module}}] \leq T_{Module}$ , you should stop the machine for module overheating protection; If  $T_{Module} < [T_{Limited \text{ frequency temperature of module}}]$  and the compressor has been stopped for 3 minutes, the machine should be allowed to operate.

6. If protection continuously occurs for six times, it should not be resumed automatically, and you should press the ON/OFF button to resume. During the process of running, if the running

time of compressor exceeds the [t Protection times clearing of module], the discharge protection is cleared to recount. Stopped or transferred to supply air mode will clear the trouble times immediately (if the trouble can not be resumed, mode transferring also will not clear it).

#### (10) Phase current overcurrent protection of compressor

During the running process of compressor, you could measure the phase current of the compressor, and control it according to the following steps:

##### 1. Frequency limited

If  $[I_{Limited \text{ frequency phase current}}] \leq [I_{Phase \text{ current T frequency reducing phase current}}]$ , you should limit the frequency raising of compressor.

##### 2. Reducing Frequency

If  $[I_{Frequency \text{ Reducing Phase Current}}] \leq [I_{Phase \text{ Current}}] < [I_{Power \text{ Turn-Off Phase Current}}]$ , the compressor shall continue to reduce frequency till the lowest frequency limit or out of the condition of reducing frequency;

##### 3. Power turn-off

If  $[I_{Phase \text{ Current}}] \geq [I_{Power \text{ Turn-Off Phase Current}}]$ , the compressor phase current shall stop working for overcurrent protection; if  $[I_{Phase \text{ Current}}] \leq [I_{Frequency \text{ Reducing Phase Current}}]$ , and the compressor have stopped working for 3 min, the machine shall be allowed to operate;

4. If the overcurrent protection of compressor phase current continuously occurs for six times, it should not be resumed automatically, and you should press the ON/OFF button to resume. During the process of running, if the running time of compressor exceeds the [t Clearing Time of Compressor Phase Current Times], the overcurrent protection is cleared to recount.

#### (11) Starting-up Failure Protection for Compressor

Stop the compressor after its starting-up fails, restart it after 20s if the fault doesn't shows, and if they are all failing for the successive start 3 times, it shall be reported as Starting-up Failure, and then restart up it after 3 min. When it still not be able to operate through carry out the above process for 5 times, it is available if press ON/OFF. And the compressor should be cleared the times after it run 2 min.

#### (12) Out-of-Step Protection for Compressor

The out-of-step protection signal should be detected immediately after starting-up compressor, and once find the out-of-step protection signal, the out-of-step protection shall be stopped; if it can run for lasting power turn-off 3 min, the machine shall be allowed to operate. If it still can't run automatically when the out-of-step protection for compressor happens to stop working for 6 times in succession, it needs to press ON/OFF to operate. And if the running time is more than 10 min, the power turn-off times for out-of-step protection shall be cleared and recounted.

#### (13) Voltage Abnormity Protection for DC Bus

To detect voltage abnormity protection for dc bus after completing the pre-charge:

##### 1. Over-Low Voltage Protection for DC Bus:

When the compressor is running, the DC bus voltage is detected. If the PFC is not opened, the bus voltage is smaller than the

VPFC does not open the undervoltage protection value time, if the PFC is turned on, the bus voltage is smaller than the VPFC Open undervoltage protection value Times Under voltage protection, under pressure protection, the compressor is closed, and the PFC is closed, and the compressor will clear the fault sign after 3 minutes.

## 2. Over-High Voltage Protection for DC Bus

When the compressor is running, if the DC bus voltage is detected is greater than the VPFC output protection value, the voltage protection is reported, the stopper, the PFC, and the compressor will clear the fault flag after 3 minutes.

### (14) Abnormity Protection for Four-way Valve

Under the model of heating operation in good condition: the compressor is detected [ $T_{\text{Inner Tube}} < (T_{\text{Inner Ring}} - T_{\text{Abnormity Temperature Difference For Four-Way Valve Reversion}})$ ], during the running, it should be regarded as four-way valve reversion abnormity. And then it can run if stop the reversion abnormity protection for four-way valve 3 min; and if it still can't run when the reversion abnormity protection for four-way valve happens to stop working for 3 times in succession, it is available if presses ON/OFF.

Attention: the protection shall be shielded during the testing mode and defrosting process, and it shall be cleared out the failure and its times immediately when turning off or delivering wind / cooling / dehumidifying mode conversed (the inverted mode don't clear out the failure when it can't recover to operate).

### (15) PFC Protection

1. After start up the PFC, it should detect the protection signal of PFC immediately; under the condition of PFC protection, it should turn off the PFC and compressor at one time;
2. It shows the failure is cleared out if PFC Protection stopped working 3 min and recovers to run automatically;
3. If it still can't run when it occurs PFC protection for 3 times in succession, it is available if presses ON/OFF; and clear the PFC Protection times when start up PFC for 10min.

### (16) Failure Detection for Sensor

1. Outdoor Ambient Sensor: detect the failure of sensor at all times.
2. Outdoor Tube Sensor: You should not detect the failure of outdoor tube sensor within 10 minutes heating operation compressor except the defrosting, and you could detect it at other time.
3. Outdoor Exhaust Sensor:
  - (a) The compressor only detect the sensor failure after it start up 3 min in normal mode;
  - (b) It should detect the exhaust sensor failure immediately in the testing mode.
4. Module Temperature Sensor:
  - (a) Short-Circuit Detection: the compressor should be detected immediately when the module temperature sensor occurs short-circuits;
  - (b) Open-Circuit Detection: the compressor should be detected on open-circuit when it runs 3min (it needn't 30s avoiding the module

over-heated).

(c) Detect the sensor failure at all times in the testing mode.

## 5. Disposal for Sensor Protection

(1) When the short-circuit of sensor is detected within 30s, It is regarded as the temperature of sensor over-high (or infinitely high), and now according to the over-high sensor, the machine should carry out the corresponding protection to stop working, and show the corresponding temperature shutdown protection and sensor failure at the same time (for example: the compressor stops immediately when the outdoor tube sensor short-circuit, and the machine shall show the overload protection and outdoor tube sensor failure).

(2) When the open-circuit of sensor is detected within 30s, The protection shall be stopped and it shall show the corresponding sensor failure.

## 6. Electric Heating Function of Chassis

- (1) When  $T_{\text{outdoor amb.}} \leq 0$ , the electric heating of chassis will operate;
- (2) When  $T_{\text{outdoor amb.}} > 2$ , the electric heating of chassis will stop operation;
- (3) When  $0 < T_{\text{outdoor amb.}} \leq 2$ , the electric heating of chassis will keep original status.

## 7. Electric Heating Function of Compressor

- (1) When  $T_{\text{outdoor amb.}} \leq -5$ , compressor stops operation, while the electric heating of compressor starts operation;
- (2) When  $T_{\text{outdoor amb.}} > -2$ , the electric heating of compressor stops operation;
- (3) When  $-5 < T_{\text{outdoor amb.}} \leq -2$ , the electric heating of compressor will keep original status.

## • UV-C lamp function instruction

### ⚠ WARNING

This appliance contains a UV emitter. Do not stare at the light source.

- This appliance contains a UV-C lamp.
- Read the maintenance instructions before opening the appliance.
- Details for cleaning and other user maintenance of the appliance:
  - (1) Prior to cleaning or other maintenance, the appliance must be disconnected from the supply mains.
  - (2) Open the panel to take out the filter.
  - (3) Use a soft cotton cloth to wipe the quartz glass until it's clean.
  - (4) Reinstall the filter when it has been cleaned and then close the panel cover.
- The method, frequency of cleaning, and necessary precautions to be taken:

Cleaning method: wipe the quartz glass with soft cloth until the surface is clean.

Cleaning frequency: clean it every 6 months; the cleaning frequency can be properly adjusted according to the degree of air cleanliness.

Preventive measures:

- (1) The unit must be turned off and the power must be cut off before cleaning. Otherwise, it may cause electric shock and damage by UV.
  - (2) Do not use volatile oil, alcohol, diluents or lacquer to clean the UV-C lamp. Otherwise, the UV-C lamp may be damaged.
  - (3) Do not touch the fins of indoor unit to prevent scalding.
  - (4) Do not scratch the surface of glass when wiping it.
- Unintended use of the appliance or damage to the housing may result in the escape of dangerous UV-C radiation. UV-C radiation may, even in small doses, cause harm to the eyes and skin.
  - Appliances that are obviously damaged must not be operated.
  - Before opening doors and access panels bearing the ultraviolet

radiation hazard Symbol for the conducting user maintenance, it is recommended to disconnect the power.

- UV-C barriers bearing the ultraviolet radiation hazard symbol should not be removed.
- Do not operate UV-C lamps outside of the appliance.

**⚠ WARNING**

Do not operate the UV-C emitter when it is removed from the appliance.

- To avoid any dangerous situations, the user shall not replace the UV-C lamp, which must be performed by the manufacturer or the professionals of the maintenance or similar department.





## 6.5 Ewpe Smart App Operation Manual

### Control Flow Chart

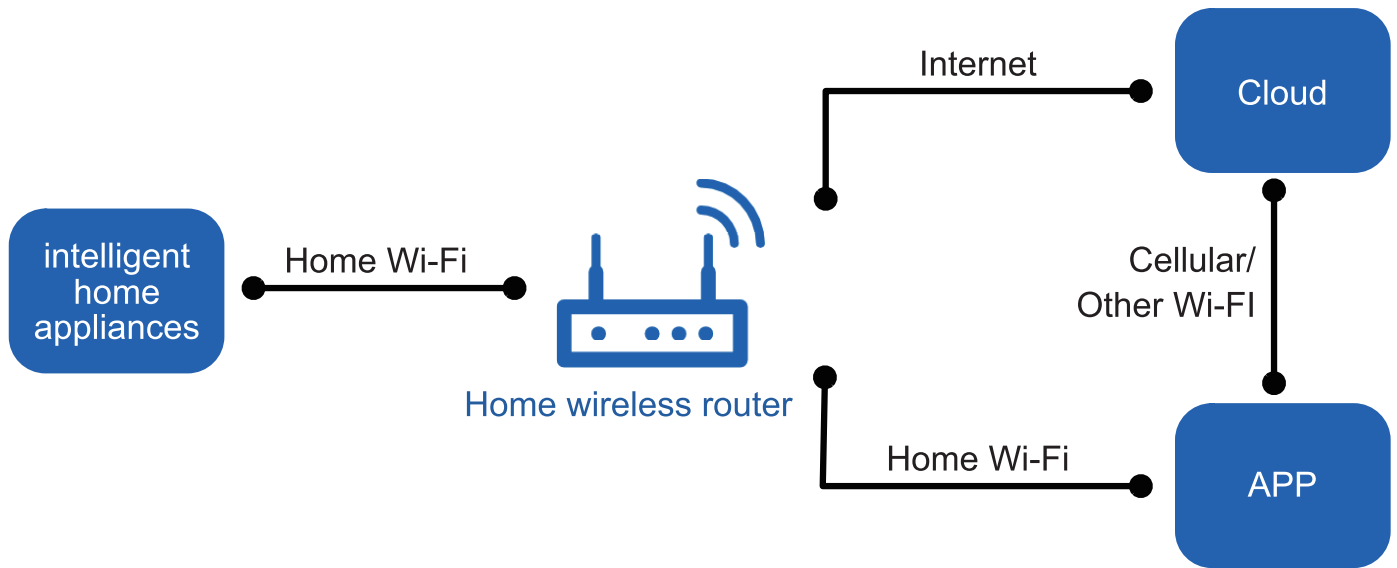

### Operating Systems

Requirement for User's smart phone:



iOS system  
Support iOS7.0 and  
above version



Android system  
Support Android 4.4 and  
above version

### Download and installation



App Download Linkage

Scan the QR code or search "Ewpe Smart" in the application market to download and install it. When "Ewpe Smart" App is installed, register the account and add the device to achieve long-distance control and LAN control of smart home appliances. For more information, please refer to "Help" in App.

# 7. Notes for Installation and Maintenance

## Safety Precautions: Important!

Please read the safety precautions carefully before installation and maintenance.

The following contents are very important for installation and maintenance.

Please follow the instructions below.

- The installation or maintenance must accord with the instructions.
- Comply with all national electrical codes and local electrical codes.
- Pay attention to the warnings and cautions in this manual.
- All installation and maintenance shall be performed by distributor or qualified person.
- All electric work must be performed by a licensed technician according to local regulations and the instructions given in this manual.
- Be caution during installation and maintenance. Prohibit incorrect operation to prevent electric shock, casualty and other accidents.

## WARNINGS

### Electrical Safety Precautions:

1. Cut off the power supply of air conditioner before checking and maintenance.
2. The air condition must apply specialized circuit and prohibit share the same circuit with other appliances.
3. The air conditioner should be installed in suitable location and ensure the power plug is touchable.
4. Make sure each wiring terminal is connected firmly during installation and maintenance.
5. Have the unit adequately grounded. The grounding wire can't be used for other purposes.
6. Must apply protective accessories such as protective boards, cable-cross loop and wire clip.
7. The live wire, neutral wire and grounding wire of power supply must be corresponding to the live wire, neutral wire and grounding wire of the air conditioner.
8. The power cord and power connection wires can't be pressed by hard objects.
9. If power cord or connection wire is broken, it must be replaced by a qualified person.
10. If the power cord or connection wire is not long enough, please get the specialized power cord or connection wire from the manufacture or distributor. Prohibit prolong the wire

by yourself.

11. For the air conditioner without plug, an air switch must be installed in the circuit. The air switch should be all-pole parting and the contact parting distance should be more than 3mm.
12. Make sure all wires and pipes are connected properly and the valves are opened before energizing.
13. Check if there is electric leakage on the unit body. If yes, please eliminate the electric leakage.
14. Replace the fuse with a new one of the same specification if it is burnt down; Don't replace it with a cooper wire or conducting wire.
15. If the unit is to be installed in a humid place, the circuit breaker must be installed.

### Installation Safety Precautions:

1. Select the installation location according to the requirement of this manual. (See the requirements in installation part)
2. Handle unit transportation with care; the unit should not be carried by only one person if it is more than 20kg.
3. When installing the indoor unit and outdoor unit, a sufficient fixing bolt must be installed; make sure the installation support is firm.
4. Ware safety belt if the height of working is above 2m.
5. Use equipped components or appointed components during installation.
6. Make sure no foreign objects are left in the unit after finishing installation.

### Refrigerant Safety Precautions:

1. When refrigerant leaks or requires discharge during installation, maintenance, or disassembly, it should be handled by certified professionals or otherwise in compliance with local laws and regulations.
2. Avoid contact between refrigerant and fire as it generates poisonous gas; Prohibit prolong the connection pipe by welding.
3. Apply specified refrigerant only. Never have it mixed with any other refrigerant. Never have air remain in the refrigerant line as it may lead to rupture or other hazards.
4. Make sure no refrigerant gas is leaking out when installation is completed.
5. If there is refrigerant leakage, please take sufficient measure to minimize the density of refrigerant.
6. Never touch the refrigerant piping or compressor without wearing glove to avoid scald or frostbite.

Improper installation may lead to fire hazard, explosion, electric shock or injury.

# Safety Precautions for Installing and Relocating the Unit:

---

To ensure safety, please be mindful of the following precautions.

## WARNINGS

**1. When installing or relocating the unit, be sure to keep the refrigerant circuit free from air or substances other than the specified refrigerant.**

Any presence of air or other foreign substance in the refrigerant circuit will cause system pressure rise or compressor rupture, resulting in injury.

**2. When installing or moving this unit, do not charge the refrigerant which is not comply with that on the nameplate or unqualified refrigerant.**

Otherwise, it may cause abnormal operation, wrong action, mechanical malfunction or even series safety accident.

**3. When refrigerant needs to be recovered during relocating or repairing the unit, be sure that the unit is running in cooling mode. Then, fully close the valve at high pressure side (liquid valve). About 30~40 seconds later, fully close the valve at low pressure side (gas valve), immediately stop the unit and disconnect power. Please note that the time for refrigerant recovery should not exceed 1 minute.**

If refrigerant recovery takes too much time, air may be sucked in and cause pressure rise or compressor rupture, resulting in injury.

**4. During refrigerant recovery, make sure that liquid valve and gas valve are fully closed and power is disconnected before detaching the connection pipe.**

If compressor starts running when stop valve is open and connection pipe is not yet connected, air will be sucked in and cause pressure rise or compressor rupture, resulting in injury.

**5. When installing the unit, make sure that connection pipe is securely connected before the compressor starts running.**

If compressor starts running when stop valve is open and connection pipe is not yet connected, air will be sucked in and cause pressure rise or compressor rupture, resulting in injury.

**6. Prohibit installing the unit at the place where there may be leaked corrosive gas or flammable gas.**

If there leaked gas around the unit, it may cause explosion and other accidents.

**7. Do not use extension cords for electrical connections. If the electric wire is not long enough, please contact a local service center authorized and ask for a proper electric wire.**

Poor connections may lead to electric shock or fire.

**8. Use the specified types of wires for electrical connections between the indoor and outdoor units. Firmly clamp the wires so that their terminals receive no external stresses.**

Electric wires with insufficient capacity, wrong wire connections and insecure wire terminals may cause electric shock or fire.



table a - Minimum room area ( m<sup>2</sup> )

Charge amount (kg)	Floor location	Window mounted	Wall mounted	Ceiling mounted
≤1.2	4	4	4	4
1.3	14.5	5.2	4	4
1.4	16.8	6.1	4	4
1.5	19.3	7	4	4
1.6	22	7.9	4	4
1.7	24.8	8.9	4	4
1.8	27.8	10	4	4
1.9	31	11.2	4	4
2	34.3	12.4	4	4
2.1	37.8	13.6	4.2	4
2.2	41.5	15	4.6	4
2.3	45.4	16.3	5	4
2.4	49.4	17.8	5.5	4
2.5	53.6	19.3	6	4

### 3. Maintenance notes

- Check whether the maintenance area or the room area meet the requirement of the nameplate.

— It's only allowed to be operated in the rooms that meet the requirement of the nameplate.

- Check whether the maintenance area is well-ventilated.

— The continuous ventilation status should be kept during the operation process.

- Check whether there is fire source or potential fire source in the maintenance area.

— The naked flame is prohibited in the maintenance area; and the "no smoking" warning board should be hanged.

- Check whether the appliance mark is in good condition.

— Replace the vague or damaged warning mark.

### 4. Welding

- If you should cut or weld the refrigerant system pipes in the process of maintaining, please follow the steps as below:

- a. Shut down the unit and cut power supply

- b. Eliminate the refrigerant

- c. Vacuuming

- d. Clean it with N<sub>2</sub> gas

- e. Cutting or welding

- f. Carry back to the service spot for welding

- Make sure that there isnt any naked flame near the outlet of the vacuum pump and its well-ventilated.

- The refrigerant should be recycled into the specialized storage tank.

### 5. Filling the refrigerant

- Use the refrigerant filling appliances specialized for R32. Make sure that different kinds of refrigerant wont contaminate with each other.

- The refrigerant tank should be kept upright at the time of filling refrigerant.

- Stick the label on the system after filling is finished (or havent finished).

- Don't overfilling.

- After filling is finished, please do the leakage detection before test running; another time of leak detection should be done when its removed.

### 6. Safety instructions for transportation and storage

- Please use the flammable gas detector to check before unload and open the container.

- No fire source and smoking.

- According to the local rules and laws.

### Specialist's Manual

- The following checks shall be applied to installations using flammable refrigerants:

- the charge size is in accordance with the room size within which the refrigerant containing parts are installed;

- the ventilation machinery and outlets are operating adequately and are not obstructed;

- if an indirect refrigerating circuit is being used, the secondary circuit shall be checked for the presence of refrigerant;

- marking to the equipment continues to be visible and legible. Markings and signs that are illegible shall be corrected;

- refrigerating pipe or components are installed in a position where they are unlikely to be exposed to any substance which may corrode refrigerant containing components, unless the components are constructed of materials which are inherently resistant to being corroded or are suitably protected against being so corroded.

- Repair and maintenance to electrical components shall include initial safety checks and component inspection procedures. If a fault exists that could compromise safety, then no electrical supply shall be connected to the circuit until it is satisfactorily dealt with. If the fault cannot be corrected



immediately but it is necessary to continue operation, an adequate temporary solution shall be used. This shall be reported to the owner of the equipment so all parties are advised.

- Initial safety checks shall include:

- that capacitors are discharged: this shall be done in a safe manner to avoid possibility of sparking;
- that no live electrical components and wiring are exposed while charging, recovering or purging the system;
- that there is continuity of earth bonding.

- Checks to the area

Prior to beginning work on systems containing flammable refrigerants, safety checks are necessary to ensure that the risk of ignition is minimised. For repair to the refrigerating system, DD.4.3 to DD.4.7 shall be completed prior to conducting work on the system.

- Work procedure

Work shall be undertaken under a controlled procedure so as to minimise the risk of a flammable gas or vapour being present while the work is being performed.

- General work area

All maintenance staff and others working in the local area shall be instructed on the nature of work being carried out. Work in confined spaces shall be avoided.

- Checking for presence of refrigerant

The area shall be checked with an appropriate refrigerant detector prior to and during work, to ensure the technician is aware of potentially toxic or flammable atmospheres. Ensure that the leak detection equipment being used is suitable for use with all applicable refrigerants, i.e. non-sparking, adequately sealed or intrinsically safe.

- Presence of fire extinguisher

If any hot work is to be conducted on the refrigerating equipment or any associated parts, appropriate fire extinguishing equipment shall be available to hand. Have a dry powder or CO<sub>2</sub> fire extinguisher adjacent to the charging area.

- No ignition sources

No person carrying out work in relation to a refrigerating system which involves exposing any pipe work shall use any sources of ignition in such a manner that it may lead to the risk of fire or explosion. All possible ignition sources, including cigarette smoking, should be kept sufficiently far away from the site of installation, repairing, removing and

disposal, during which refrigerant can possibly be released to the surrounding space.

Prior to work taking place, the area around the equipment is to be surveyed to make sure that there are no flammable hazards or ignition risks. "No Smoking" signs shall be displayed.

- Ventilated area

Ensure that the area is in the open or that it is adequately ventilated before breaking into the system or conducting any hot work. A degree of ventilation shall continue during the period that the work is carried out. The ventilation should safely disperse any released refrigerant and preferably expel it externally into the atmosphere.

- Checks to the refrigerating equipment

Where electrical components are being changed, they shall be fit for the purpose and to the correct specification. At all times the manufacturer's maintenance and service guidelines shall be followed. If in doubt, consult the manufacturer's technical department for assistance.

The following checks shall be applied to installations using flammable refrigerants:

- the actual refrigerant charge is in accordance with the room size within which the refrigerant containing parts are installed;
- the ventilation machinery and outlets are operating adequately and are not obstructed;
- if an indirect refrigerating circuit is being used, the secondary circuit shall be checked for the presence of refrigerant;
- marking to the equipment continues to be visible and legible. Markings and signs that are illegible shall be corrected;
- refrigerating pipe or components are installed in a position where they are unlikely to be exposed to any substance which may corrode refrigerant containing components, unless the components are constructed of materials which are inherently resistant to being corroded or are suitably protected against being so corroded.

- Checks to electrical devices

Repair and maintenance to electrical components shall include initial safety checks and component inspection procedures. If a fault exists that could compromise safety, then no electrical supply shall be connected to the circuit until it is satisfactorily dealt with. If the fault cannot be corrected immediately but it is necessary to continue



operation, an adequate temporary solution shall be used. This shall be reported to the owner of the equipment so all parties are advised.

Initial safety checks shall include:

- that capacitors are discharged: this shall be done in a safe manner to avoid possibility of sparking;
- that no live electrical components and wiring are exposed while charging, recovering or purging the system;
- that there is continuity of earth bonding.

#### • Repairs to sealed components

During repairs to sealed components, all electrical supplies shall be disconnected from the equipment being worked upon prior to any removal of sealed covers, etc. If it is absolutely necessary to have an electrical supply to equipment during servicing, then a permanently operating form of leak detection shall be located at the most critical point to warn of a potentially hazardous situation.

Particular attention shall be paid to the following to ensure that by working on electrical components, the casing is not altered in such a way that the level of protection is affected. This shall include damage to cables, excessive number of connections, terminals not made to original specification, damage to seals, incorrect fitting of glands, etc.

- Ensure that the apparatus is mounted securely.
- Ensure that seals or sealing materials have not degraded to the point that they no longer serve the purpose of preventing the ingress of flammable atmospheres. Replacement parts shall be in accordance with the manufacturer's specifications.

**NOTE:** The use of silicon sealant can inhibit the effectiveness of some types of leak detection equipment. Intrinsically safe components do not have to be isolated prior to working on them.

#### • Repair to intrinsically safe components

Do not apply any permanent inductive or capacitance loads to the circuit without ensuring that this will not exceed the permissible voltage and current permitted for the equipment in use.

Intrinsically safe components are the only types that can be worked on while live in the presence of a flammable atmosphere. The test apparatus shall be at the correct rating.

Replace components only with parts specified by the manufacturer. Other parts may result in the ignition of refrigerant in the atmosphere from a leak.

#### • Cabling

Check that cabling will not be subject to wear, corrosion, excessive pressure, vibration, sharp edges or any other adverse environmental effects. The check shall also take into account the effects of aging or continual vibration from sources such as compressors or fans.

#### • Detection of flammable refrigerants

Under no circumstances shall potential sources of ignition be used in the searching for or detection of refrigerant leaks. A halide torch (or any other detector using a naked flame) shall not be used.

#### • Leak detection methods

The following leak detection methods are deemed acceptable for all refrigerant systems.

Electronic leak detectors may be used to detect refrigerant leaks but, in the case of flammable refrigerants, the sensitivity may not be adequate, or may need recalibration. (Detection equipment shall be calibrated in a refrigerant-free area.) Ensure that the detector is not a potential source of ignition and is suitable for the refrigerant used. Leak detection equipment shall be set at a percentage of the LFL of the refrigerant and shall be calibrated to the refrigerant employed, and the appropriate percentage of gas (25% maximum) is confirmed.

Leak detection fluids are also suitable for use with most refrigerants but the use of detergents containing chlorine shall be avoided as the chlorine may react with the refrigerant and corrode the copper pipe-work.

If a leak is suspected, all naked flames shall be removed/extinguished.

If a leakage of refrigerant is found which requires brazing, all of the refrigerant shall be recovered from the system, or isolated (by means of shut off valves) in a part of the system remote from the leak. For appliances containing flammable refrigerants, oxygen free nitrogen (OFN) shall then be purged through the system both before and during the brazing process.

#### • Removal and evacuation

When breaking into the refrigerant circuit to make repairs — or for any other purpose — conventional procedures shall be used. However, for flammable refrigerants it is important that best practice is followed since flammability is a consideration. The following procedure shall be adhered to:

- remove refrigerant;
- purge the circuit with inert gas;
- evacuate;

- purge with inert gas;
- open the circuit by cutting or brazing.

The refrigerant charge shall be recovered into the correct recovery cylinders. For appliances containing flammable refrigerants, the system shall be "flushed" with OFN to render the unit safe. This process may need to be repeated several times. Compressed air or oxygen shall not be used for purging refrigerant systems.

For appliances containing flammable refrigerants, flushing shall be achieved by breaking the vacuum in the system with OFN and continuing to fill until the working pressure is achieved, then venting to atmosphere, and finally pulling down to a vacuum. This process shall be repeated until no refrigerant is within the system. When the final OFN charge is used, the system shall be vented down to atmospheric pressure to enable work to take place. This operation is absolutely vital if brazing operations on the pipe-work are to take place.

Ensure that the outlet for the vacuum pump is not close to any ignition sources and that ventilation is available.

#### • Charging procedures

In addition to conventional charging procedures, the following requirements shall be followed.

- Ensure that contamination of different refrigerants does not occur when using charging equipment. Hoses or lines shall be as short as possible to minimise the amount of refrigerant contained in them.
- Cylinders shall be kept in an appropriate position according to the instructions.
- Ensure that the refrigerating system is earthed prior to charging the system with refrigerant.
- Label the system when charging is complete (if not already).
- Extreme care shall be taken not to overfill the refrigerating system.

Prior to recharging the system, it shall be pressure-tested with the appropriate purging gas. The system shall be leak-tested on completion of charging but prior to commissioning. A follow up leak test shall be carried out prior to leaving the site.

#### • Decommissioning

Before carrying out this procedure, it is essential that the technician is completely familiar with the equipment and all its detail. It is recommended good practice that all refrigerants are recovered safely. Prior to the task being

carried out, an oil and refrigerant sample shall be taken in case analysis is required prior to re-use of recovered refrigerant. It is essential that electrical power is available before the task is commenced.

- Become familiar with the equipment and its operation.
- Isolate system electrically.
- Before attempting the procedure, ensure that:
  - mechanical handling equipment is available, if required, for handling refrigerant cylinders;
  - all personal protective equipment is available and being used correctly;
  - the recovery process is supervised at all times by a competent person;
  - recovery equipment and cylinders conform to the appropriate standards.
- Pump down refrigerant system, if possible.
- If a vacuum is not possible, make a manifold so that refrigerant can be removed from various parts of the system.
- Make sure that cylinder is situated on the scales before recovery takes place.
- Start the recovery machine and operate in accordance with manufacturer's instructions.
- Do not overfill cylinders. (No more than 80% volume liquid charge).
- Do not exceed the maximum working pressure of the cylinder, even temporarily.
- When the cylinders have been filled correctly and the process completed, make sure that the cylinders and the equipment are removed from site promptly and all isolation valves on the equipment are closed off.
- Recovered refrigerant shall not be charged into another refrigerating system unless it has been cleaned and checked.

#### • Labelling

Equipment shall be labelled stating that it has been decommissioned and emptied of refrigerant. The label shall be dated and signed. For appliances containing flammable refrigerants, ensure that there are labels on the equipment stating the equipment contains flammable refrigerant.

#### • Recovery

When removing refrigerant from a system, either for servicing or decommissioning, it is recommended good practice that all refrigerants are removed safely.

When transferring refrigerant into cylinders, ensure that only

appropriate refrigerant recovery cylinders are employed. Ensure that the correct number of cylinders for holding the total system charge is available. All cylinders to be used are designated for the recovered refrigerant and labelled for that refrigerant (i.e. special cylinders for the recovery of refrigerant). Cylinders shall be complete with pressure-relief valve and associated shut-off valves in good working order. Empty recovery cylinders are evacuated and, if possible, cooled before recovery occurs.

The recovery equipment shall be in good working order with a set of instructions concerning the equipment that is at hand and shall be suitable for the recovery of all appropriate refrigerants including, when applicable, flammable refrigerants. In addition, a set of calibrated weighing scales shall be available and in good working order. Hoses shall be complete with leak-free disconnect couplings and in good condition. Before using the recovery machine, check that it is in satisfactory working order, has been properly maintained and that any associated electrical components are sealed to prevent ignition in the event of a refrigerant release. Consult manufacturer if in doubt.

The recovered refrigerant shall be returned to the refrigerant supplier in the correct recovery cylinder, and the relevant waste transfer note arranged. Do not mix refrigerants in recovery units and especially not in cylinders.

If compressors or compressor oils are to be removed, ensure that they have been evacuated to an acceptable level to make certain that flammable refrigerant does not remain within the lubricant. The evacuation process shall be carried out prior to returning the compressor to the suppliers. Only electric heating to the compressor body shall be employed to accelerate this process. When oil is drained from a system, it shall be carried out safely.

- General

That the installation of pipe-work shall be kept to a minimum.

That compliance with national gas regulations shall be observed.

That mechanical connections made in accordance with 22.118 shall be accessible for maintenance purposes.



# 8. Installation

## 8.1 Installation Dimension Diagram

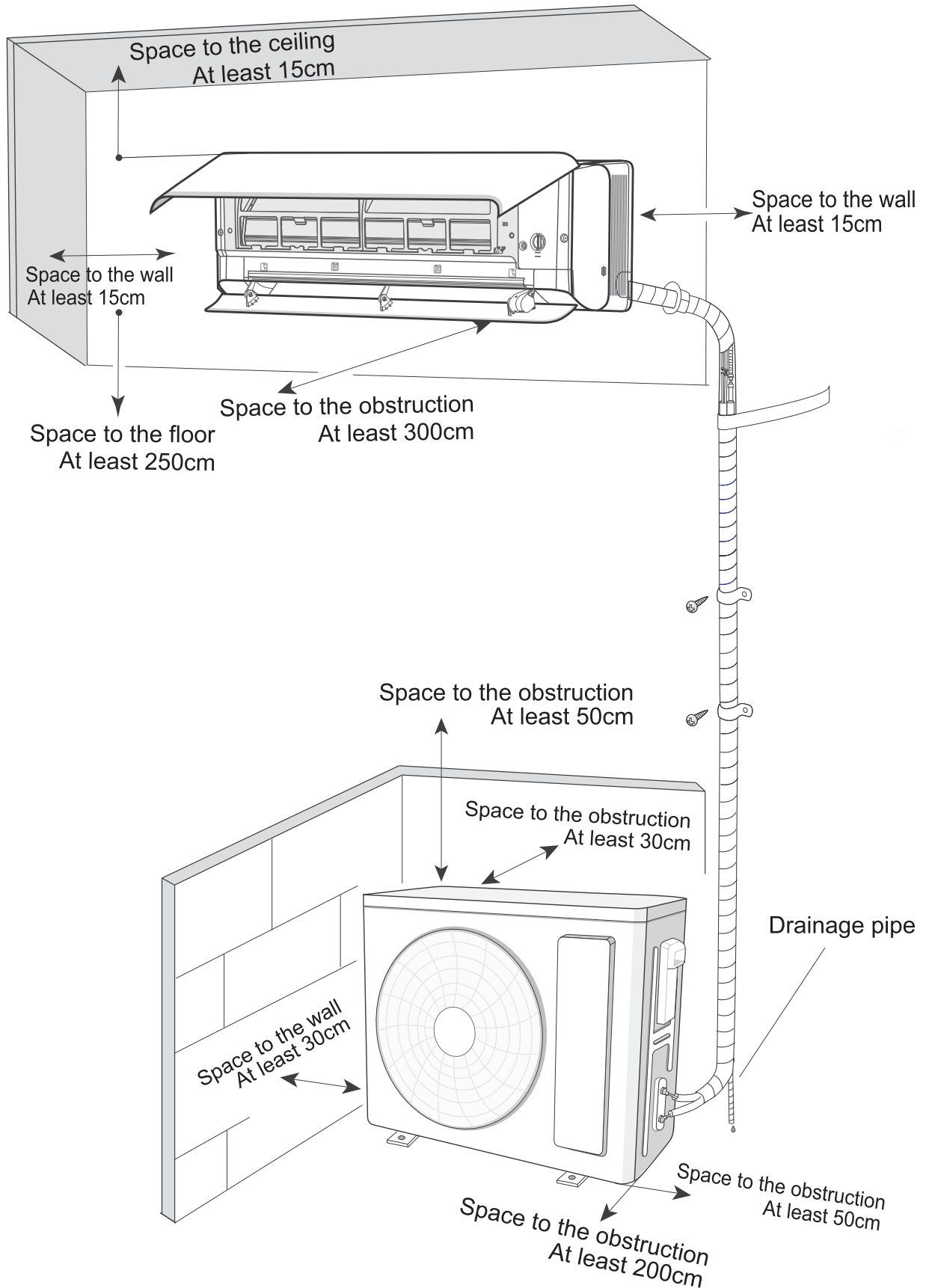

## Installation Procedures

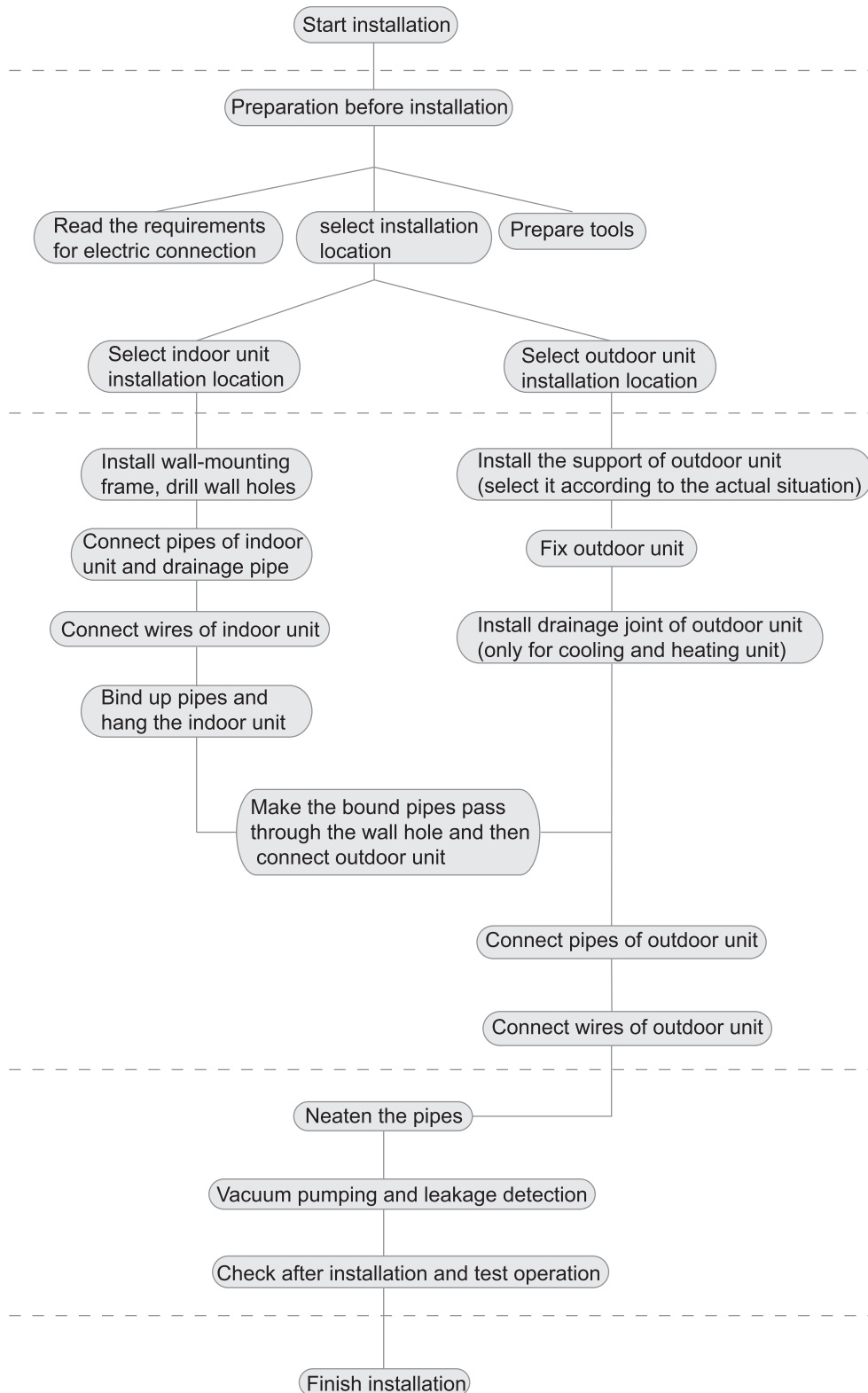

Note: this flow is only for reference; please find the more detailed installation steps in this section.



## 8.2 Installation Parts-checking

No.	Name	No.	Name
1	Indoor unit	8	Sealing gum
2	Outdoor unit	9	Wrapping tape
3	Connection pipe	10	Support of outdoor unit
4	Drainage pipe	11	Fixing screw
5	Wall-mounting frame	12	Drainage plug (Heat pump model)
6	Connecting cable (Power Cord)	13	Owners manual
7	Wall pipe	14	Remote controller

### ⚠ NOTE:

1. Please contact the local agent for installation.
2. Don't use unqualified power cord.

## 8.3 Selection of Installation Location

### 1. Basic Requirement

Installing the unit in the following places may cause malfunction. If it is unavoidable, please consult the local dealer:

- (1) The place with strong heat sources, vapors, flammable or explosive gas, or volatile objects spread in the air.
- (2) The place with high-frequency devices (such as welding machine, medical equipment).
- (3) The place near coast area.
- (4) The place with oil or fumes in the air.
- (5) The place with sulfureted gas.
- (6) Other places with special circumstances.
- (7) The appliance shall not be installed in the laundry.
- (8) It's not allowed to be installed on the unstable or motive base structure (such as truck) or in the corrosive environment (such as chemical factory).

### 2. Indoor Unit

- (1) There should be no obstruction near air inlet and air outlet.
- (2) Select a location where the condensation water can be dispersed easily and won't affect other people.
- (3) Select a location which is convenient to connect the outdoor unit and near the power socket.
- (4) Select a location which is out of reach for children.
- (5) The location should be able to withstand the weight of indoor unit and won't increase noise and vibration.

- (6) The appliance must be installed 2.5m above floor.
- (7) Don't install the indoor unit right above the electric appliance.
- (8) Please try your best to keep way from fluorescent lamp.

### 3. Outdoor Unit

- (1) Select a location where the noise and outflow air emitted by the outdoor unit will not affect neighborhood.
- (2) The location should be well ventilated and dry, in which the outdoor unit won't be exposed directly to sunlight or strong wind.
- (3) The location should be able to withstand the weight of outdoor unit.
- (4) Make sure that the installation follows the requirement of installation dimension diagram.
- (5) Select a location which is out of reach for children and far away from animals or plants. If it is unavoidable, please add fence for safety purpose.

## 8.4 Electric Connection Requirement

### 1. Safety Precaution

- (1) Must follow the electric safety regulations when installing the unit.
- (2) According to the local safety regulations, use qualified power supply circuit and air switch.
- (3) Make sure the power supply matches with the requirement of air conditioner. Unstable power supply or incorrect wiring may result in electric shock, fire hazard or malfunction. Please install proper power supply cables before using the air conditioner.
- (4) Properly connect the live wire, neutral wire and grounding wire of power socket.
- (5) Be sure to cut off the power supply before proceeding any work related to electricity and safety.
- (6) Do not put through the power before finishing installation.
- (7) The temperature of refrigerant circuit will be high, please keep the interconnection cable away from the copper tube.
- (8) The appliance shall be installed in accordance with national wiring regulations.

### 2. Grounding Requirement

- (1) The air conditioner is I class electric appliance. It must be properly grounding with specialized grounding device by a professional. Please make sure it is always grounded effectively, otherwise it may cause electric shock.
- (2) The yellow-green wire in air conditioner is grounding wire, which can't be used for other purposes.
- (3) The grounding resistance should comply with national electric safety regulations.



- (4) The appliance must be positioned so that the plug is accessible.
- (5) An all-pole disconnection switch having a contact separation of at least 3mm in all poles should be connected in fixed wiring.
- (6) Including an air switch with suitable capacity, please note the following table. Air switch should be included magnet buckle and heating buckle function, it can protect the circuit-short and overload. (Caution: please do not use the fuse only for protect the circuit)

Model	Air switch capacity	Power cord
09K / 12K	10A	3G1.0
18K	16A	3G1.5
24K	25A	3G2.5

## 8.5 Installation of Indoor Unit

### 1. Choosing Installation Location

Recommend the installation location to the client and then confirm it with the client.

### 2. Install Wall-mounting Frame

(1) Hang the wall-mounting frame on the wall; adjust it in horizontal position with the level meter and then point out the screw fixing holes on the wall.

(2) Drill the screw fixing holes on the wall with impact drill (the specification of drill head should be the same as the plastic expansion particle) and then fill the plastic expansion particles in the holes.

(3) Fix the wall-mounting frame on the wall with tapping screws and then check if the frame is firmly installed by pulling the frame. If the plastic expansion particle is loose, please drill another fixing hole nearby.

### 3. Drill Piping Hole

(1) Choose the position of piping hole according to the direction of outlet pipe. The position of piping hole should be a little lower than the wall-mounted frame. (As show in Fig.1)

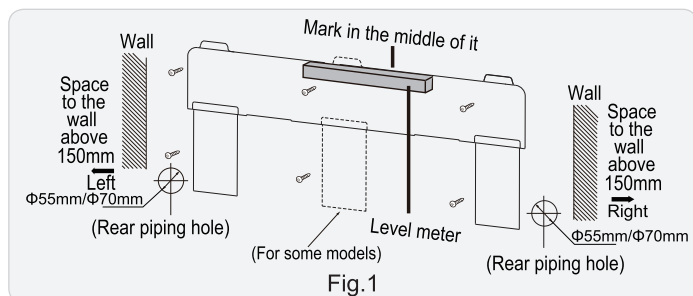

(2) When installation is finished, pull the mounting plate with hand to confirm whether it is fixed tightly. The force distribution for all screws should be uniform.

(3) Drill a piping hole with the diameter of  $\Phi 55\text{mm}$  or  $\Phi 70\text{mm}$  on

the selected outlet pipe position. In order to drain smoothly, slant the piping hole on the wall slightly downward to the outdoor side with the gradient of  $5-10^\circ$ . (As show in Fig.2)

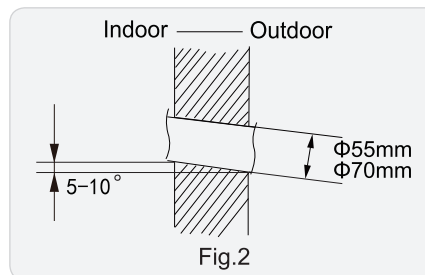

#### NOTE:

- Pay attention to dust prevention and take relevant safety measures when drilling the hole.

### 4. Outlet Pipe

(1) The pipe can be led out in the direction of right, rear right, left or rear left. (As show in Fig.3)

(2) When selecting leading out the pipe from left or right, please cut off the corresponding hole on the bottom case. (As show in Fig.4)

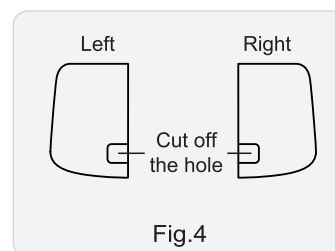
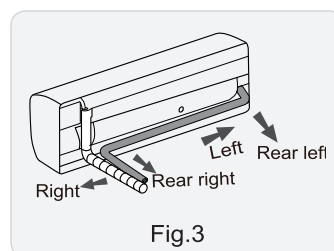

### 5. Connect the Pipe of Indoor Unit

(1) Aim the pipe joint at the corresponding bellmouth. (As show in Fig.5)

(2) Pretightening the union nut with hand.

(3) Adjust the torque force by referring to the following sheet. Place the open-end wrench on the pipe joint and place the torque wrench on the union nut. Tighten the union nut with torque wrench. (As show in Fig.6)

(4) Wrap the indoor pipe and joint of connection pipe with insulating pipe, and then wrap it with tape. (As show in Fig.7)

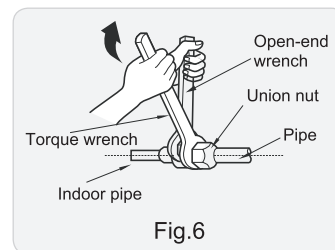
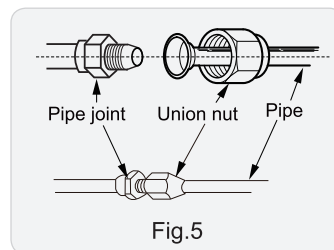

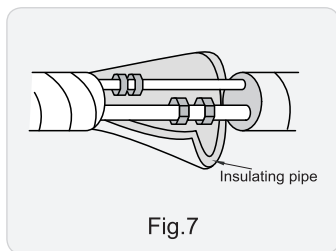

Fig.7

Refer to the following table for wrench moment of force:

Piping size (inch)	Tightening torque (N·m)
1/4	15~20
3/8	30~40
1/2	45~55
5/8	60~65
3/4	70~75

## 6. Install Drain Hose

(1) Connect the drain hose to the outlet pipe of indoor unit. (As show in Fig.8)

(2) Bind the joint with tape. (As show in Fig.9)

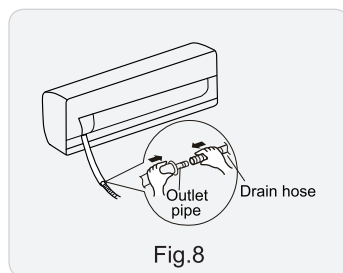

Fig.8

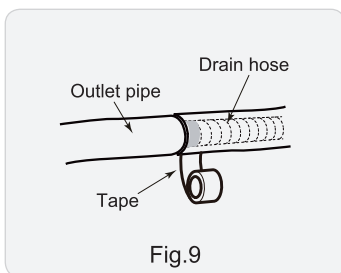

Fig.9

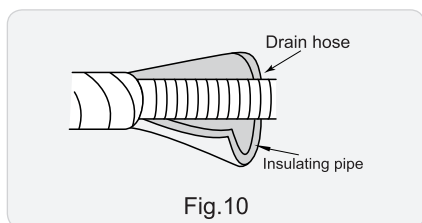

Fig.10

### NOTE:

- Add insulating pipe in the indoor drain hose in order to prevent condensation.
- The plastic expansion particles are not provided.

## 7. Connect Wire of Indoor Unit

### NOTICE:

- All wires of indoor unit and outdoor unit should be connected by a professional.
- If the length of power connection wire is insufficient, please contact the supplier for a new one. Avoid extending the wire by yourself.

- For the air conditioner with plug, the plug should be reachable after finishing installation.

- For the air conditioner without plug, an air switch must be installed in the line. The air switch should be all-pole parting and the contact parting distance should be more than 3mm.

(1) Open the panel, remove the screw on the wiring cover and then take down the cover. (As show in Fig.11)

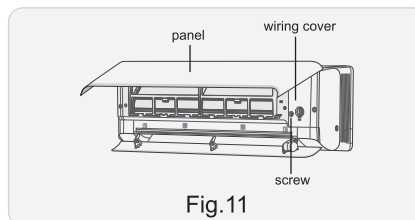

Fig.11

(2) Make the power connection wire go through the cable-cross hole at the back of indoor unit and then pull it out from the front side. (As show in Fig.12)

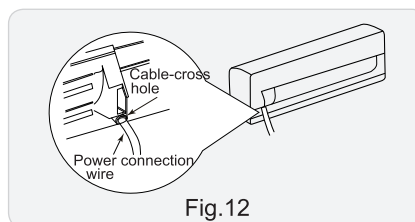

Fig.12

(3) Remove the wire clip; connect the power connection wiresignal control wire (only for cooling and heating unit) to the wiring terminal according to the color; tighten the screw and then fix the power connection wire with wire clip. (As show in Fig.13)

(4) Put wiring cover back and then tighten the screw.

(5) Close the panel.

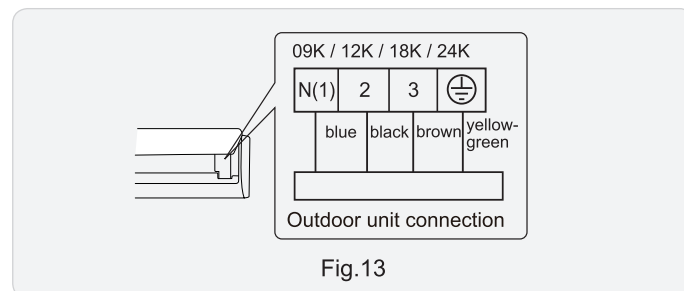

Fig.13

### NOTICE:

- The wiring board is for reference only, please refer to the actual one.

## 8. Bind up Pipe

(1) Bind up the connection pipe, power cord and drain hose with the band. (As show in Fig.14)

(2) Reserve a certain length of drain hose and power cord for installation when binding them. When binding to a certain degree, separate the indoor power and then separate the drain hose. (As show in Fig.15)

(3) Bind them evenly.

(4) The liquid pipe and gas pipe should be bound separately at the end.

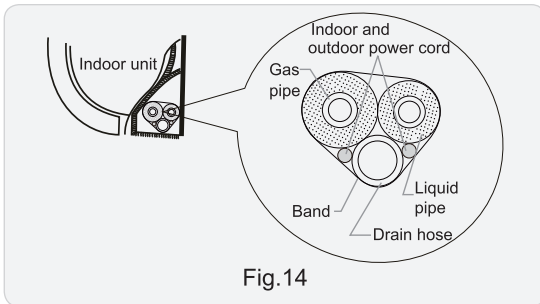

Fig.14

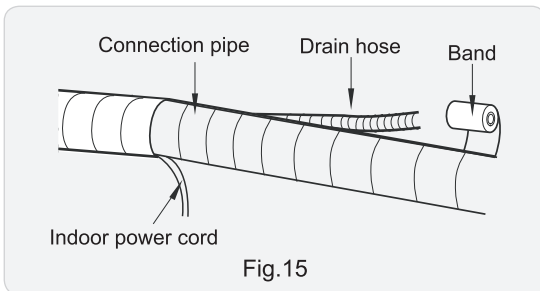

Fig.15

**NOTE:**

- The power cord and control wire can't be crossed or winding.
- The drain hose should be bound at the bottom.

**9. Hang the Indoor Unit**

(1) Put the bound pipes in the wall pipe and then make them pass through the wall hole.

(2) Hang the indoor unit on the wall-mounting frame.

(3) Stuff the gap between pipes and wall hole with sealing gum.

(4) Fix the wall pipe. (As show in Fig.16)

(5) Check if the indoor unit is installed firmly and closed to the wall. (As show in Fig.17)

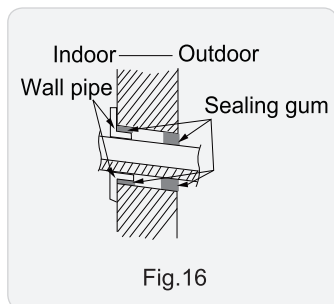

Fig.16

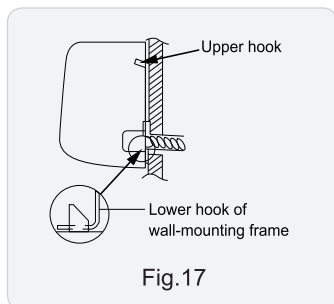

Fig.17

**NOTE:**

- Do not bend the drain hose too excessively in order to prevent blocking.

**8.6 Installation of Outdoor Unit**

**1. Fix the Support of Outdoor Unit (Select it according**

**to the actual installation situation)**

(1) Select installation location according to the house structure.

(2) Fix the support of outdoor unit on the selected location with expansion screws.

**NOTICE:**

- Take sufficient protective measures when installing the outdoor unit.
- Make sure the support can withstand at least four times the unit weight.
- The outdoor unit should be installed at least 3cm above the floor in order to install drain joint.(As show in Fig.18)
- For the unit with cooling capacity of 2300W~5000W, 6 expansion screws are needed; for the unit with cooling capacity of 6000W~8000W, 8 expansion screws are needed; for the unit with cooling capacity of 10000W~16000W, 10 expansion screws are needed.

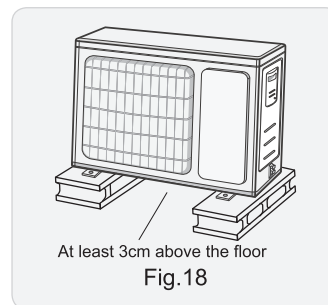

Fig.18

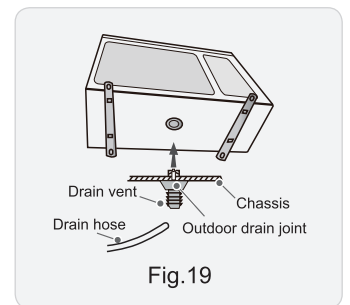

Fig.19

**2. Install Drain Joint (Only for heat pump models)**

(1) Connect the outdoor drain joint into the hole on the chassis.

(2) Connect the drain hose into the drain vent. (As show in Fig.19)

**NOTICE:**

- As for the shape of drainage joint, please refer to the current product. Do not install the drainage joint in the severe cold area. Otherwise, it will be frosted and then cause malfunction.

**3. Fix Outdoor Unit**

(1) Place the outdoor unit on the support.

(2) Fix the foot holes of outdoor unit with bolts. (As show in Fig.20)

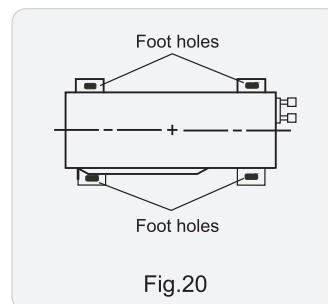

Fig.20

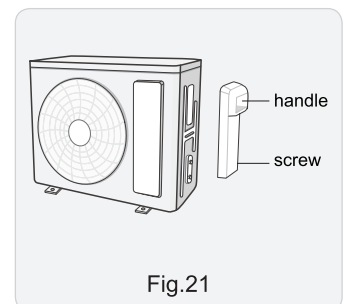
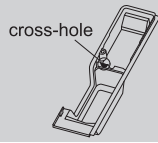

Fig.21

**NOTE:**

- When there're multiple cables passing through it, the cross-hole of handle should be knocked off and eliminate the sharp burrs for avoid damaging the cables. Only applicable for some models.



**4. Connect Indoor and Outdoor Pipes**

- (1) Remove the screw on the right handle of outdoor unit and then remove the handle. (As show in Fig.21)
- (2) Remove the screw cap of valve and aim the pipe joint at the bellmouth of pipe. (As show in Fig.22)

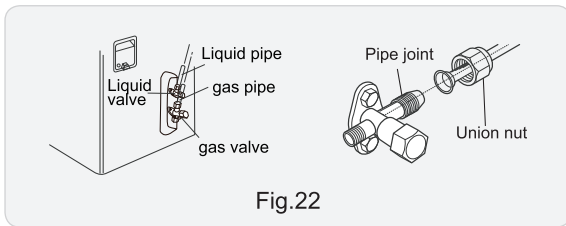

Fig.22

- (3) Pretightening the union nut with hand.
- (4) Tighten the union nut with torque wrench .

Refer to the following table for wrench moment of force:

Piping size (inch)	Tightening torque (N·m)
1/4	15~20
3/8	30~40
1/2	45~55
5/8	60~65
3/4	70~75

**5. Connect Outdoor Electric Wire**

- (1) Remove the wire clip; connect the power connection wire and signal control wire (only for cooling and heating unit) to the wiring terminal according to the color; fix them with screws. (As show in Fig.23)

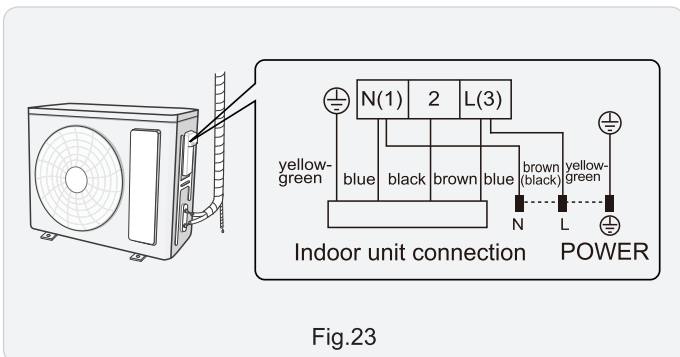

Fig.23

**NOTICE:**

- The wiring board is for reference only, please refer to the actual one.
- (2) Fix the power connection wire and signal control wire with wire clip (only for heat pump models).

**NOTICE:**

- After tightening the screw, pull the power cord slightly to check if it is firm.
- Never cut the power connection wire to prolong or shorten the distance.

**6. Neaten the Pipes**

- (1) The pipes should be placed along the wall, bent reasonably and hidden possibly. Min. semidiameter of bending the pipe is 10cm.
- (2) If the outdoor unit is higher than the wall hole, you must set a U-shaped curve in the pipe before pipe goes into the room, in order to prevent rain from getting into the room. (As show in Fig.24)

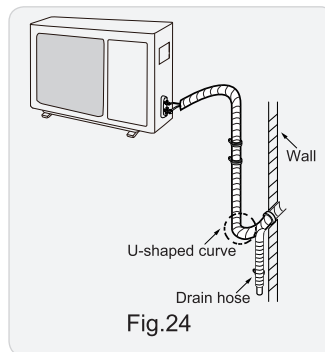

Fig.24

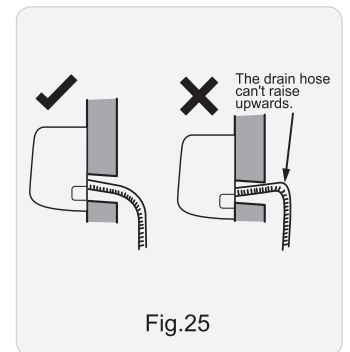

Fig.25

**NOTICE:**

- The through-wall height of drain hose shouldnt be higher than the outlet pipe hole of indoor unit.(As show in Fig.25)
- Slant the drain hose slightly downwards. The drain hose cant be curved, raised and fluctuant, etc.(As show in Fig.26)
- The water outlet cant be placed in water in order to drain smoothly.(As show in Fig.27)

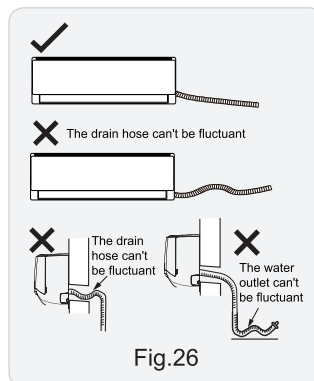

Fig.26



Fig.27

**8.7 Vacuum Pumping and Leak Detection**

**1. Use Vacuum Pump**

- (1) Remove the valve caps on the liquid valve and gas valve and the nut of refrigerant charging vent.

(2) Connect the charging hose of piezometer to the refrigerant charging vent of gas valve and then connect the other charging hose to the vacuum pump.

(3) Open the piezometer completely and operate for 10-15min to check if the pressure of piezometer remains in -0.1MPa.

(4) Close the vacuum pump and maintain this status for 1-2min to check if the pressure of piezometer remains in -0.1MPa. If the pressure decreases, there may be leakage.

(5) Remove the piezometer, open the valve core of liquid valve and gas valve completely with inner hexagon spanner.

(6) Tighten the screw caps of valves and refrigerant charging vent. (As show in Fig.28)

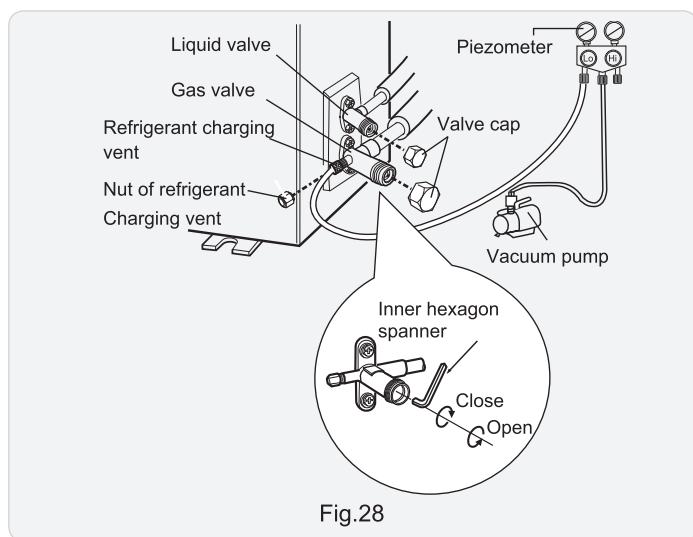

Fig.28

## 2. Leakage Detection

(1) With leakage detector:

Check if there is leakage with leakage detector.

(2) With soap water:

If leakage detector is not available, please use soap water for leakage detection. Apply soap water at the suspected position and keep the soap water for more than 3min. If there are air bubbles coming out of this position, There's a leakage.

## 8.8 Check after Installation and Test Operation

### 1. Check after Installation

Check according to the following requirement after finishing installation.

NO.	Items to be checked	Possible malfunction
1	Has the unit been installed firmly?	The unit may drop, shake or emit noise.
2	Have you done the refrigerant leakage test?	It may cause insufficient cooling (heating) capacity.
3	Is heat insulation of pipeline sufficient?	It may cause condensation and water dripping.
4	Is water drained well?	It may cause condensation and water dripping.
5	Is the voltage of power supply according to the voltage marked on the nameplate?	It may cause malfunction or damage the parts.
6	Is electric wiring and pipeline installed correctly?	It may cause malfunction or damage the parts.
7	Is the unit grounded securely?	It may cause electric leakage.
8	Does the power cord follow the specification?	It may cause malfunction or damage the parts.
9	Is there any obstruction in air inlet and air outlet?	It may cause insufficient cooling (heating) capacity.
10	The dust and sundries caused during installation are removed?	It may cause malfunction or damaging the parts.
11	The gas valve and liquid valve of connection pipe are open completely?	It may cause insufficient cooling (heating) capacity.
12	Is the inlet and outlet of piping hole been covered?	It may cause insufficient cooling(heating) capacity or waster eletricity.

## 2. Test Operation

### ⚠ WARNING

When the air conditioner is installed, please ask the qualified professional personnel to tear off three adhesive tapes before handle over the unit to the customer for operation. Do not extend the hand into the air outlet. It may cause personal injury.

**Method:** When the air conditioner is energized and then air louver is opened and at the static status, tear off adhesive tapes from outside to inside with appropriate force.

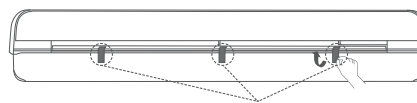

yellow adhesive tapes

(1) Preparation of test operation

- The client approves the air conditioner installation.
- Specify the important notes for air conditioner to the client.

(3) Method of test operation

- Put through the power, press ON/OFF button on the remote controller to start operation.
- Press MODE button to select AUTO, COOL, DRY, FAN and HEAT to check whether the operation is normal or not.
- If the ambient temperature is lower than 16°C, the air conditioner can't start cooling.



# 9. Maintenance

## 9.1 Error Code List

Error code	Malfunction name	AC status	Possible causes
<b>E5</b>	Malfunction of jumper cap	The complete unit stops operation	<ol style="list-style-type: none"> <li>1. Jumper cap is not installed in control panel;</li> <li>2. Poor contact of jumper cap;</li> <li>3. Jumper cap is damaged;</li> <li>4. The tested circuit of jumper cap on control panel is abnormal.</li> </ol>
<b>E6</b>	Communication malfunction between indoor unit and outdoor unit	Cool: compressor stops operation, while indoor fan operates; Heat: all loads stops operation.	See "Communication malfunction"
<b>H5</b>	IPM protection	Cool/Dry: compressor stops operation, while indoor fan operates. Heat: all loads stops operation.	See "IPM protection, over-phase current of compressor"
<b>L3</b> <b>LA</b>	Malfunction of outdoor fan/ malfunction of DC motor	Cool/Dry: all loads stops operation except indoor fan. Heat: all loads stops operation.	<ol style="list-style-type: none"> <li>1. Outdoor condenser, air inlet and air outlet are blocked by filth or dirt;</li> <li>2. Fan is blocked or loosened;</li> <li>3. Motor or connection wire of motor is damaged;</li> <li>4. Main board of outdoor unit is damaged;</li> </ol> (As for dual-outdoor fan, L3 indicates fan 1; LA indicates fan 2)
<b>H3</b>	Overload protection of compressor	Cool/Dry: compressor stops operation, while indoor fan operates. Heat: all loads stops operation.	<ol style="list-style-type: none"> <li>1. Overload wire of compressor is loose;</li> <li>2. The overload protector is damaged. Under normal circumstances, the resistance between both ends of terminal is less than 1ohm.</li> <li>3. See "Overload protection of compressor , High discharge temperature protection of compressor"</li> </ol>
<b>F0</b>	Refrigerant insufficient protection, cut-off protection of refrigerant	Cool: compressor and outdoor fan stops operation, while indoor fan operates; Heat: Compressor, outdoor fan and indoor fan stops operation.	<ol style="list-style-type: none"> <li>1. Is system cooling under high humidity environment, thus temperature difference of heat transfer is small;</li> <li>2. Check whether the big valve and small valve of outdoor unit are opened completely;</li> <li>3. Is the temperature sensor of evaporator of indoor unit loose?</li> <li>4. Is the temperature sensor of condenser of outdoor unit loose?</li> <li>5. Is the capillary or the electronic expansion valve blocked?</li> <li>6. Is refrigerant leaking?</li> </ol>
<b>F1</b>	Indoor ambient temperature sensor is open/short-circuited	Cool/Dry: indoor fan operates, while compressor and outdoor fan stops operation; Heat: all loads stops operation.	<ol style="list-style-type: none"> <li>1. Temperature sensor is not well connected;</li> <li>2. Temperature sensor is damaged 3. Main board of indoor unit is damaged.</li> </ol>
<b>F2</b>	Indoor evaporator temperature sensor is open/short-circuited	Cool/Dry: indoor fan operates, while compressor and outdoor fan stops operation; Heat: all loads stops operation.	<ol style="list-style-type: none"> <li>1. Temperature sensor is not well connected;</li> <li>2. Temperature sensor is damaged</li> <li>3. Main board of indoor unit is damaged.</li> </ol>
<b>H6</b>	No feedback from indoor unit's motor	The complete unit stops operation	<ol style="list-style-type: none"> <li>1. Is the fan blocked?</li> <li>2. Is the motor terminal loose?</li> <li>3. Is the connection wire of motor damaged?</li> <li>4. Is the motor damaged?</li> <li>5. Is the main board of indoor unit damaged?</li> </ol>
<b>LP</b>	Indoor unit and outdoor unit can be matched with each other	Heat: compressor, outdoor unit and indoor fan stops operation.	Capacity of indoor unit and outdoor unit can't be matched.
<b>C4</b>	Malfunction of jumper cap of outdoor unit	Heat: all loads are stopped; other modes: outdoor unit stops operation.	Jumper cap of outdoor unit hasn't been installed.
<b>b7</b>	Gas valve temperature sensor is ON / short-circuited		<ol style="list-style-type: none"> <li>1. Temperature sensor is not well connected or damaged;</li> <li>2. The wire of temperature sensor is damaged, causing short circuit to copper pipe or outer casing;</li> <li>3. Main board of outdoor unit is damaged.</li> </ol>



Error code	Malfunction name	AC status	Possible causes
<b>b5</b>	Liquid valve temperature sensor is ON / short-circuited		<ol style="list-style-type: none"> <li>1. Temperature sensor is not well connected or damaged;</li> <li>2. The wire of temperature sensor is damaged, causing short circuit to copper pipe or outer casing;</li> <li>3. Main board of outdoor unit is damaged.</li> </ol>
<b>E1</b>	High pressure protection of system	Cool/Dry: all loads stops operation except indoor fan; Heat: all loads stops operation.	<ol style="list-style-type: none"> <li>1. Heat exchange of outdoor unit is too dirty, or it blocked the air inlet/outlet;</li> <li>2. Is power voltage normal; (three-phase unit)</li> <li>3. Ambient temperature is too high;</li> <li>4. Wiring of high pressure switch is loose or high pressure switch is damaged;</li> <li>5. The internal system is blocked; (dirt blockage, ice blockage, oil blockage, angle valve is not completely opened)</li> <li>6. Main board of outdoor unit is damaged;</li> <li>7. Refrigerant is too much.</li> </ol>
<b>E3</b>	Low pressure/low system pressure protection/ compressor low pressure protection	Cool: compressor, outdoor fan and indoor fan stop operation; Heat: compressor and outdoor fan stop operation at first. About 1 minute later, indoor fan stops operation; 2 minutes later, the 4-way valve stop operation.	<ol style="list-style-type: none"> <li>1. Low pressure switch is damaged;</li> <li>2. Refrigerant inside the system is insufficient.</li> </ol>
<b>E4</b>	High discharge temperature protection of compressor	Cool/Dry: compressor and outdoor fan stops operation, while indoor fan operates; Heat: all loads stops operation.	See "Overload protection of compressor , High discharge temperature protection of compressor"
<b>E5</b>	AC overcurrent protection	Cool/Dry: compressor and outdoor fan stops operation, while indoor fan operates; Heat: all loads stops operation.	<ol style="list-style-type: none"> <li>1. Power voltage is unstable;</li> <li>2. Power voltage is too low;</li> <li>3. System load is too high, which leads to high current;</li> <li>4. Heat exchange of indoor unit is too dirty, or it blocked the air inlet/outlet;</li> <li>5. Fan motor operation is abnormal; the fan speed is too low or not functioning;</li> <li>6. Compressor is blocked;</li> <li>7. The internal system is blocked; (dirt blockage, ice blockage, oil blockage, angle valve is not completely opened)</li> <li>8. Main board of outdoor unit is damaged.</li> </ol> See "AC overcurrent protection"
<b>E7</b>	Mode shock/sysmte mode shock	Load of indoor unit stops operation (indoor fan, E-heater, swing)	Malfunction of one-to-more system; there may be two indoor units which has set the shock mode, such as one is cooling and the other is heating.
<b>E8</b>	High temperature prevention protection	Cool: compressor stops operation while indoor fan operates; Heat: all loads stops operation.	See "High temperature prevention protection; high power; system is abnormal"
<b>EE</b>	Malfunction of EEPROM	Cool/Dry: compressor stops operation, while indoor fan operates; Heat: all loads stops operation.	Main board of outdoor unit is damaged.
<b>F0</b>	Refrigerant-recovery mode	Cool/Dry: compressor and outdoor fan stops operation, while indoor fan operates.	Refrigerant recovery. The maintenance personnel operate it when he is maintaining the unit.
<b>F3</b>	Outdoor ambient temperature is open/short-circuited	Cool/Dry: compressor and outdoor fan stop operation, while indoor fan operates; Heat: all loads stops operation.	<ol style="list-style-type: none"> <li>1. Temperature sensor is not connected well or damaged;</li> <li>2. Temperature sensor wire of outdoor unit is damaged; short circuit between the temperature sensor and copper pipe or outer case;</li> <li>3. Main board of outdoor unit is damaged;</li> </ol>

Error code	Malfunction name	AC status	Possible causes
F4	Outdoor condenser temperature sensor is open/short-circuited	Cool/Dry: compressor and outdoor fan stop operation, while indoor fan operates; Heat: after operating for 3 minutes, all loads stops operation.	1. Temperature sensor is not connected well or damaged; 2. Temperature sensor wire of outdoor unit is damaged; short circuit between the temperature sensor and copper pipe or outer case; 3. Main board of outdoor unit is damaged.
F5	Outdoor air discharge temperature is open/short-circuited	Complete unit stops operation; motor of sliding door is cut off power.	1. The exhaust temperature sensor is not connected well or damaged. 2. Temperature sensor wire of outdoor unit is damaged; short circuit between the temperature sensor and copper pipe or outer case 3. Main board of outdoor unit is damaged;
FC	Malfunction of micro switch	Cool/Dry: compressor stops operation, while indoor fan operates; Heat: all loads stops operation.	1. The sliding door is blocked; 2. Malfunction of the photoelectric inspection panel of sliding door;
H4	System is abnormal	Cool/Dry: all loads stops operation except indoor fan; Heat: all loads stops operation.	See "High temperature prevention protection; high power; system is abnormal"
H7	Desynchronizing of compressor	Cool/Dry: compressor stops operation, while indoor fan operates; Heat: all loads stops operation.	See "Desynchronization diagnosis for compressor"
HC	PFC protection	Cool/Dry: compressor stops operation, while indoor fan operates; Heat: all loads stops operation.	1. The power grid quality is bad; AC input voltage fluctuates sharply; 2. Power plug of air conditioner or wiring board or reactor is not connected reliably; 3. Indoor and outdoor heat exchanger is too dirty, or air inlet/outlet is blocked; 4. Main board of outdoor unit is damaged.
HE	Demagnetization protection of compressor	Cool: compressor and outdoor fan stop operation; Heat: compressor and outdoor fan stop operation at first; about 1 minute later, indoor fan stops operation.	1. The main board of outdoor unit is damaged; 2. Compressor is damaged;
JF	Communication malfunction between indoor unit and inspection board	Normal operation	1. Poor connection between the indoor unit and the inspection board. 2. The main board of indoor unit is damaged; 3. The inspection board is damaged;
L1	Malfunction of humidity sensor	Compressor, outdoor fan and indoor fan stop operation;	The inspection board is damaged.
L9	High power protection	Cool: compressor and outdoor fan stops operation, while indoor fan operates.	See "High temperature prevention protection; high power; system is abnormal"
Lc	Start-up failed	Cool/Dry: compressor stops, while indoor fan operates; Heat: all loads stops operation.	See "Malfunction diagnosis for failure startup"
Ld	Lost phase	Cool: compressor and outdoor fan stop operation; Heat: compressor and outdoor fan stop operation at first; about 1 minute later, indoor fan stops operation.	1. The main board of outdoor unit is damaged; 2. The compressor is damaged; 3. The connection wire of compressor is not connected well.
PS	Over-phase current protection of compressor	Cool/Dry: compressor stops operation, while indoor fan operates; Heat: all loads stops operation.	See "Overload protection of compressor , High discharge temperature protection of compressor"

Error code	Malfunction name	AC status	Possible causes
<b>oE</b>	Undefined outdoor unit error	Cool: compressor and outdoor fan stops operation, while indoor fan operates; Heat: compressor, outdoor fan and indoor fan stop operation.	<ol style="list-style-type: none"> <li>1. Outdoor ambient temperature exceeds the operation range of unit (e.g.: less than 20°C or more than 60°C for cooling; more than 30°C for heating);</li> <li>2. Are wires of compressor not connected tightly?</li> <li>3. Failure startup of compressor?</li> <li>4. Is compressor damaged?</li> <li>5. Is main board damaged?</li> </ol>
<b>P6</b>	Communication malfunction between the drive board and the main board	Cool: compressor and outdoor fan stops operation; Heat: compressor and outdoor fan stop at first; about 1 minute later, indoor fan stops operation;	<ol style="list-style-type: none"> <li>1. The drive board is damaged;</li> <li>2. The main board of outdoor unit is damaged;</li> <li>3. The drive board and the main board is not connected well.</li> </ol>
<b>P7</b>	Circuit malfunction of module temperature sensor	Cool/Dry: compressor stops operation, while indoor fan operates; Heat: all loads stops operation.	Replace outdoor control board
<b>P8</b>	Module overheating protection	Cool: compressor stops operation, while indoor fan operates; Heat: all loads stops operation.	<ol style="list-style-type: none"> <li>1. Air inlet / air outlet of outdoor unit are blocked by filth or dirt;</li> <li>2. Condenser of outdoor unit is blocked by filth or dirt;</li> <li>3. IPM screw of main board is not tightened;</li> <li>4. Main board of outdoor unit is damaged;</li> </ol>
<b>PF</b>	Malfunction of ambient temperature sensor of drive board	Cool: compressor, outdoor fan and indoor fan stop operation; Heat: compressor and outdoor fan stop operation at first; about 1 minute later, indoor fan stops operation.	<ol style="list-style-type: none"> <li>1. The ambient temperature sensor of the drive board is not connected well;</li> <li>2. Malfunction of the ambient temperature sensor of drive board.</li> </ol>
<b>PH</b>	DC bus voltage is too high	Cool/Dry: compressor stops operation, while indoor fan operates; Heat: all loads stops operation.	<ol style="list-style-type: none"> <li>1. Measure the voltage between position L and position N on the wiring board (XT). If it's higher than 265 VAC, please turn on the unit until the power voltage is decreased to the normal range;</li> <li>2. If the AC input is normal, please replace the outdoor control board.</li> </ol>
<b>PL</b>	DC bus voltage is too low	Cool/Dry: compressor stops operation, while indoor fan operates; Heat: all loads stops operation.	<ol style="list-style-type: none"> <li>1. Measure the voltage between position L and position N on the wiring board (XT). If it's lower than 150 VAC, please turn on the unit until the power voltage is increased to the normal range;</li> <li>2. If the AC input is normal, please replace the outdoor control board.</li> </ol>
<b>PU</b>	Charging malfunction of capacitor	Cool/Dry: compressor stops operation, while indoor fan operates; Heat: all loads stops operation.	See "Charging malfunction of capacitor"
<b>rF</b>	Malfunction of RF module	Cool: compressor and outdoor fan stop operation; Heat: compressor and outdoor fan stop operation at first; about 1 minute later, indoor fan stops operation.	<ol style="list-style-type: none"> <li>1. The connection wire of RF module is not connected well.</li> <li>2. Malfunction of RF module;</li> </ol>
<b>U1</b>	Phase current detection circuit malfunction of	Cool: compressor and outdoor fan stops operation, while indoor fan operates; Heat: compressor, outdoor fan and indoor fan stops operation.	The control board is damaged
<b>U2</b>	Lost phase protection of compressor	Cool: compressor and outdoor fan stop operation; Heat: compressor and outdoor fan stop operation at first; about 1 minute later, indoor fan stops operation.	<ol style="list-style-type: none"> <li>1. The main board of outdoor unit is damaged;</li> <li>2. The compressor is damaged;</li> <li>3. The connection wire of compressor is not connected well.</li> </ol>

Error code	Malfunction name	AC status	Possible causes
U3	DC bus voltage drop malfunction	Cool/Dry: compressor stops operation, while indoor fan operates; Heat: all loads stops operation.	The power voltage is unstable.
U5	Current detection malfunction of unit	Cool: compressor and outdoor fan stops operation, while indoor fan operates; Heat: compressor, outdoor fan and indoor fan stops operation.	1. Is the complete unit lacking of refrigerant? 2. There's malfunction for the circuit of control board of outdoor unit. Replace the control board of outdoor unit.
U7	4-way valve is abnormal	This malfunction occurs when the unit is heating. All loads stops operation.	1. Power voltage is lower than AC175V; 2. Wiring terminal of 4-way valve is loose or broken;3. 4-way valve is damaged. Replace the 4-way valve.
U8	Malfunction of zero-crossing signal of indoor unit	Compressor, outdoor fan and indoor fan stop operation.	1. The power is abnormal; 2. Main board of indoor unit is damaged.
U9	Zero-crossing malfunction of outdoor unit	Cool: compressor stops operation, while indoor fan operates; Heat: all loads stops operation.	Replace the control board of outdoor unit.
E2	Evaporator anti-freezing protection		Not error code, it is the status code in cooling process
E9	Anti cold air protection		Not error code, it is the status code in cooling process
	Defrosting	Heat indicator Flash once/10s	Not error code, it is the status code in cooling process

### Analysis or processing of some of the malfunction display:

#### 1. Compressor discharge protection

Possible causes: shortage of refrigerant; blockage of air filter; poor ventilation or air flow short pass for condenser; the system has noncondensing gas (such as air, water etc.); Blockage of capillary assy (including filter); leakage inside four-way valve causes incorrect operation; malfunction of compressor; malfunction of protection relay; malfunction of discharge sensor; outdoor temperature too high.

Processing method: refer to the malfunction analysis in the above section.

#### 2. Low voltage overcurrent protection

Possible cause: Sudden drop of supply voltage.

#### 3. Communication malfunction

Processing method: Check if communication signal cable is connected reliably.

#### 4. Sensor open or short circuit

Processing method: Check whether sensor is normal, connected with the corresponding position on the controller and if damage of lead wire is found.

#### 5. Compressor over load protection

Possible causes: insufficient or too much refrigerant; blockage of capillary and increase of suction temp.; improper running of compressor, burning in or stuck of bearing, damage of discharge valve; malfunction of protector.

Processing method: adjust refrigerant amount; replace the capillary; replace the compressor; use universal meter to check if the contactor of compress or is fine when it is not overheated, if not replace the protector.

#### 6. System malfunction

i.e. overload protection. When tube temperature(Check the temperature of outdoor heat exchanger when cooling and check the temperature of indoor heat exchanger when heating) is too high, protection will be activated.

Possible causes: Outdoor temperature is too high when cooling; insufficient outdoor air circulation; refrigerant flow malfunction.

Please refer to the malfunction analysis in the previous section for handling method .

#### 7. IPM module protection

Processing method: Once the module malfunction happens, if it persists for a long time and can not be self-canceled, cut off the power and turn off the unit, and then re-energize the unit again after about 10 min. After repeating the procedure for sever times, if the malfunction still exists, replace the module.



## 2. Communication malfunction ㉟

Main check points:

- (1) Connection wire between indoor unit and outdoor unit
- (2) Wiring inside the unit
- (3) Communication circuit of control board of indoor unit
- (4) Communication circuit of control board of outdoor unit

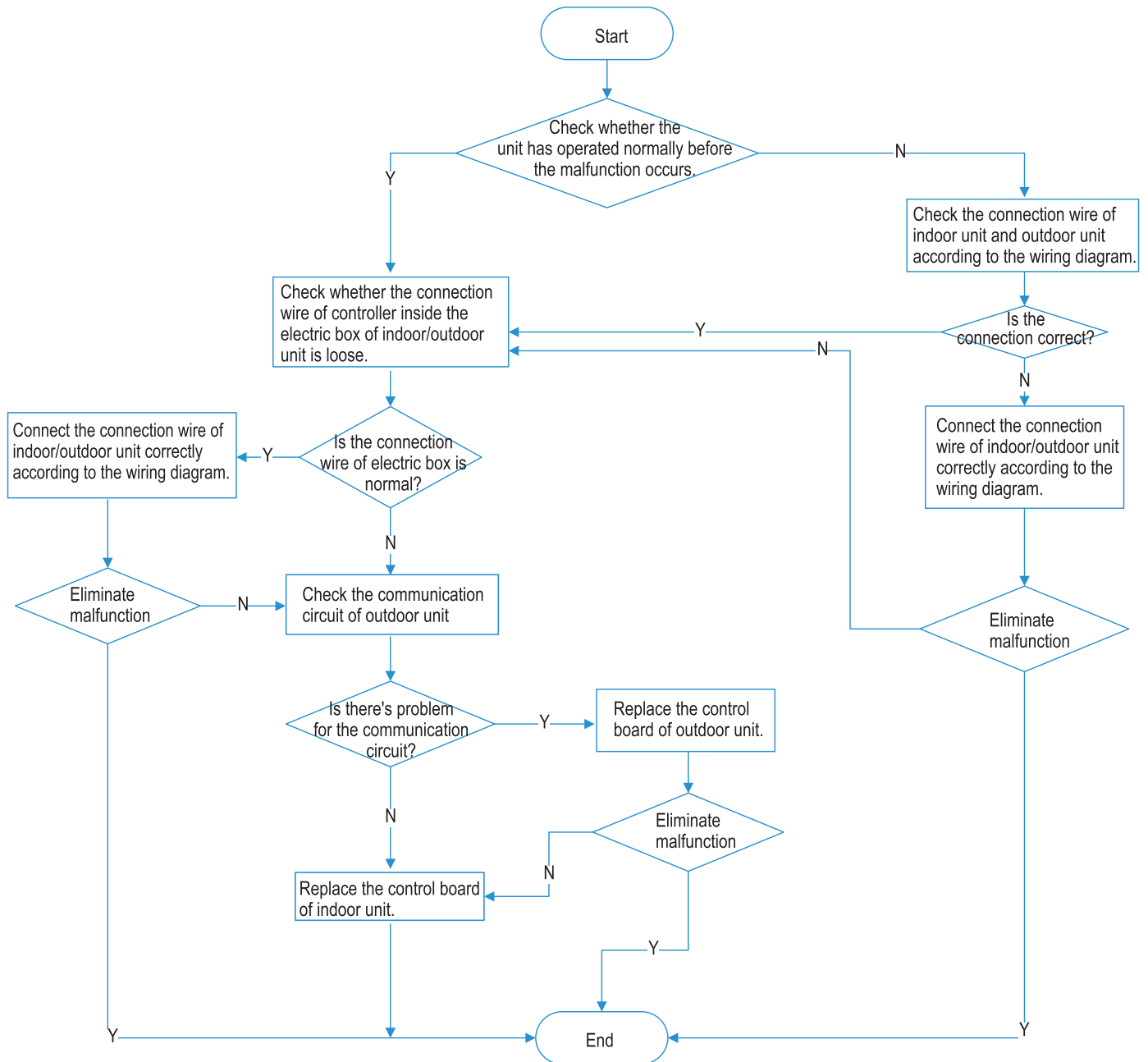



### 3. IPM protection H5, over-phase current of compressor P5

Main check points:

- (1) compressor COMP terminal
- (2) power supply voltage
- (3) compressor
- (4) charging amount of refrigerant
- (5) air inlet and air outlet of indoor/outdoor unit

NOTE: The control board as below means the control board of outdoor unit.

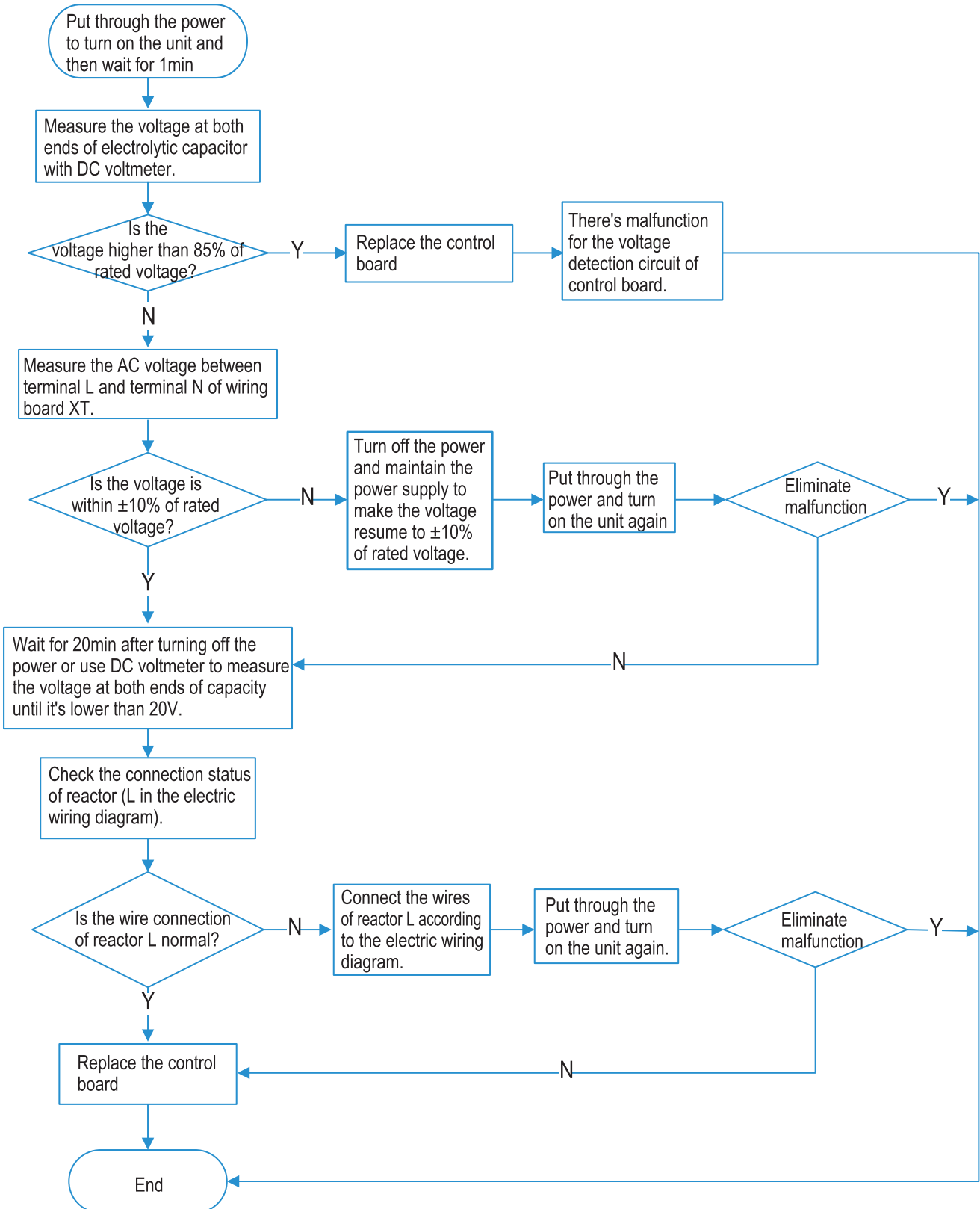

## 4. Overload protection of compressor H3, high discharge temperature, protection of compressor E4

Main check points:

- (1) electronic expansion valve
- (2) expansion valve terminal
- (3) charging amount of refrigerant
- (4) overload protector

NOTE: The control board as below means the control board of outdoor unit.

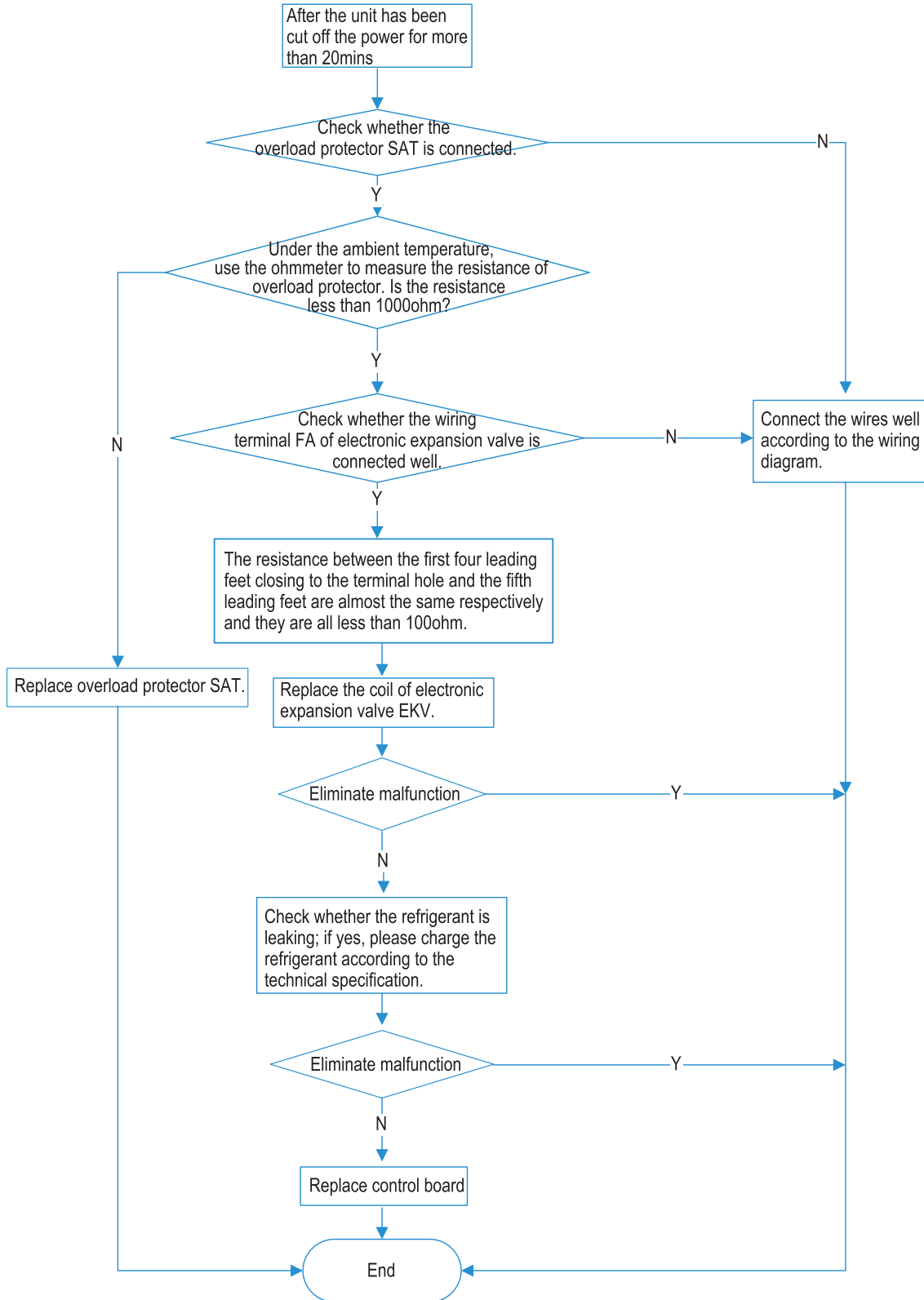

## 5. Troubleshooting for temperature sensor F1,F2,F3,F4,F5

Main check points:

(1) connection terminal (2) temperature sensor (3) main board

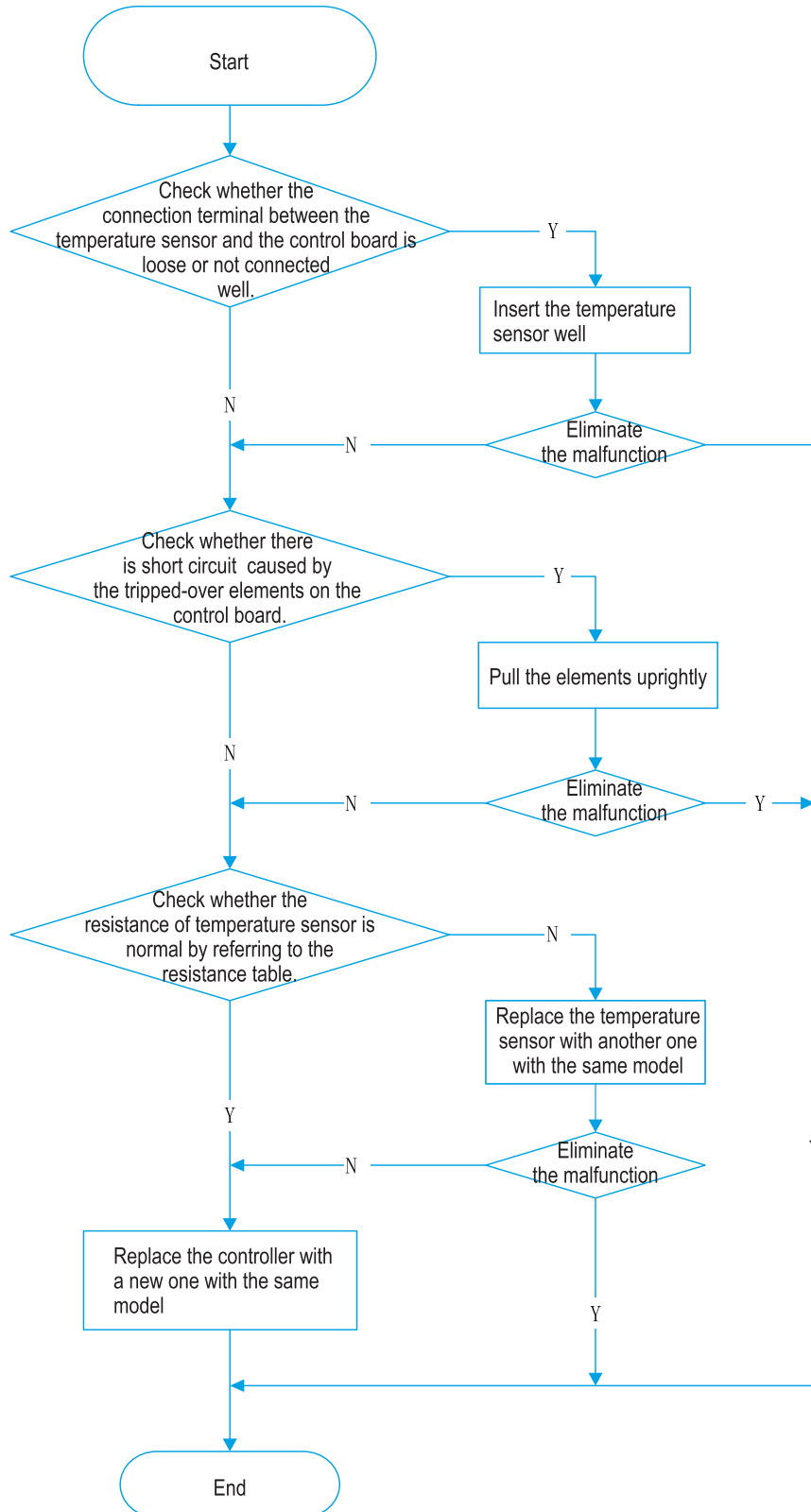

## 6. High temperature prevention protection E8; high power L9; system is abnormal H4

Main check points:

(1) outdoor temperature (2) fan (3)air inlet and air outlet of indoor/outdoor unit

NOTE: The control board as below means the control board of outdoor unit.

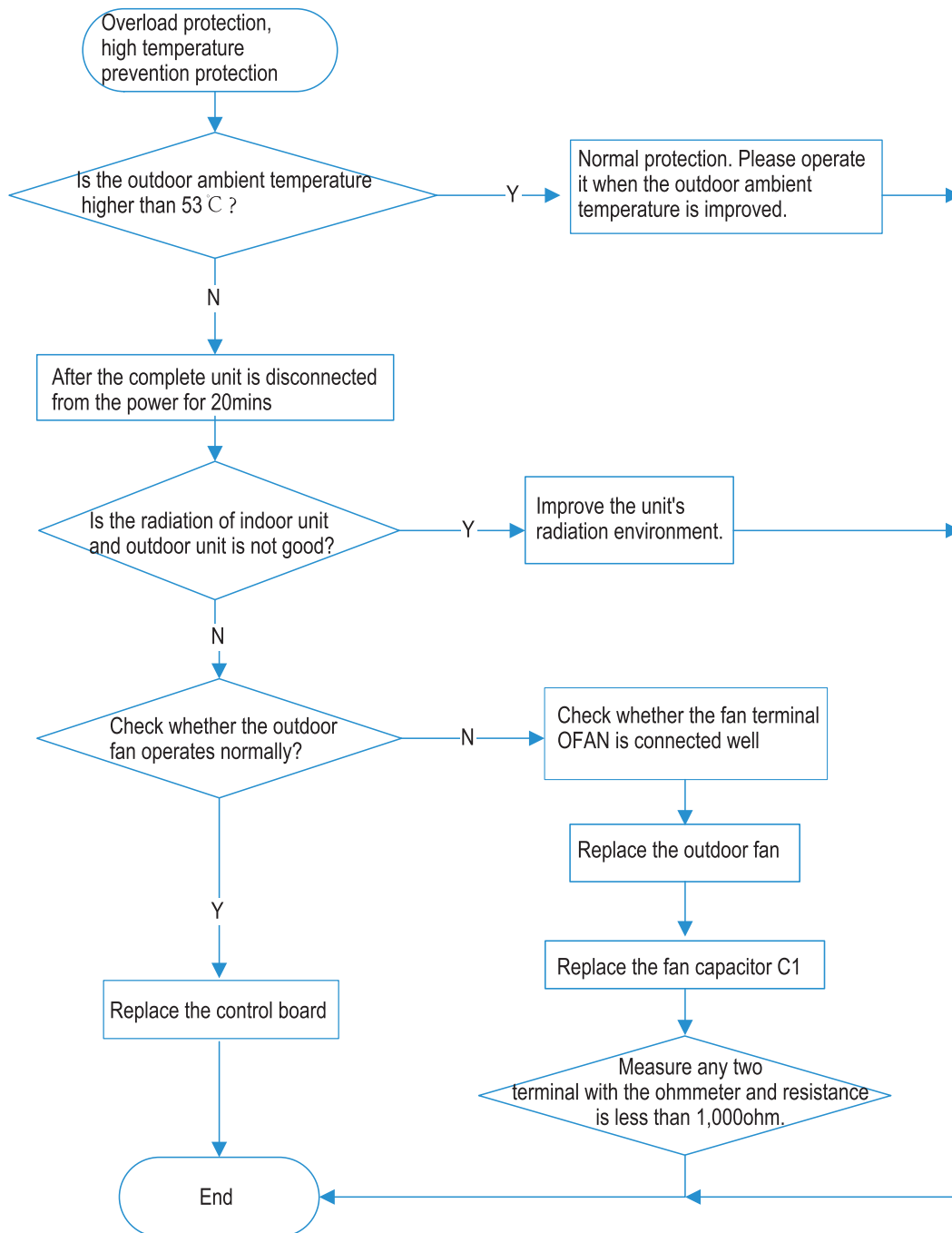



## 8. Malfunction diagnosis for failure startup $L_c$

Main check points:

(1) compressor wire (2) compressor (3) charging amount of refrigerant

NOTE: The control board as below means the control board of outdoor unit.

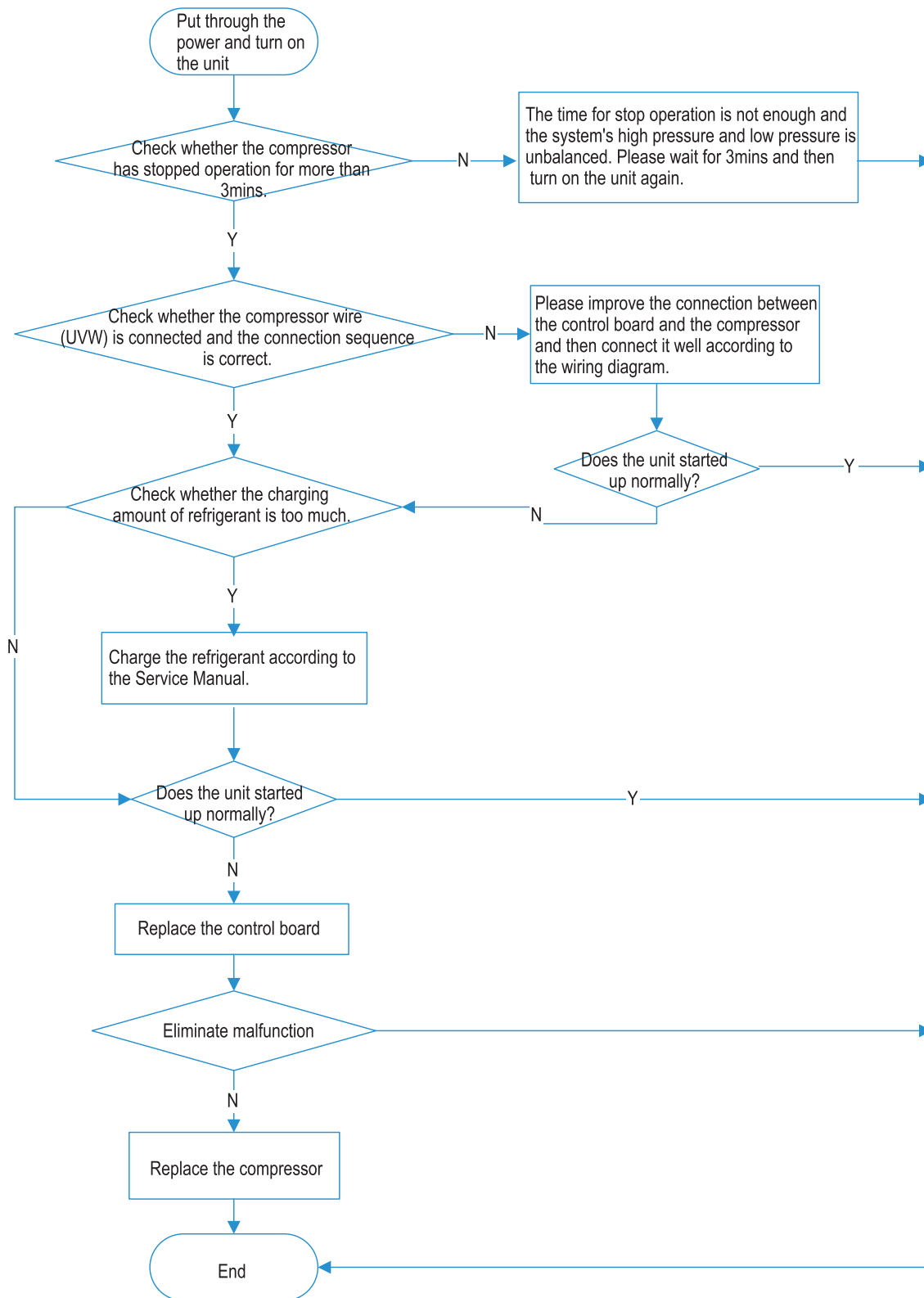



## 9. Charging malfunction of capacitor PU

Main check points:

(1) wiring board XT (2) reactor

NOTE: The control board as below means the control board of outdoor unit.

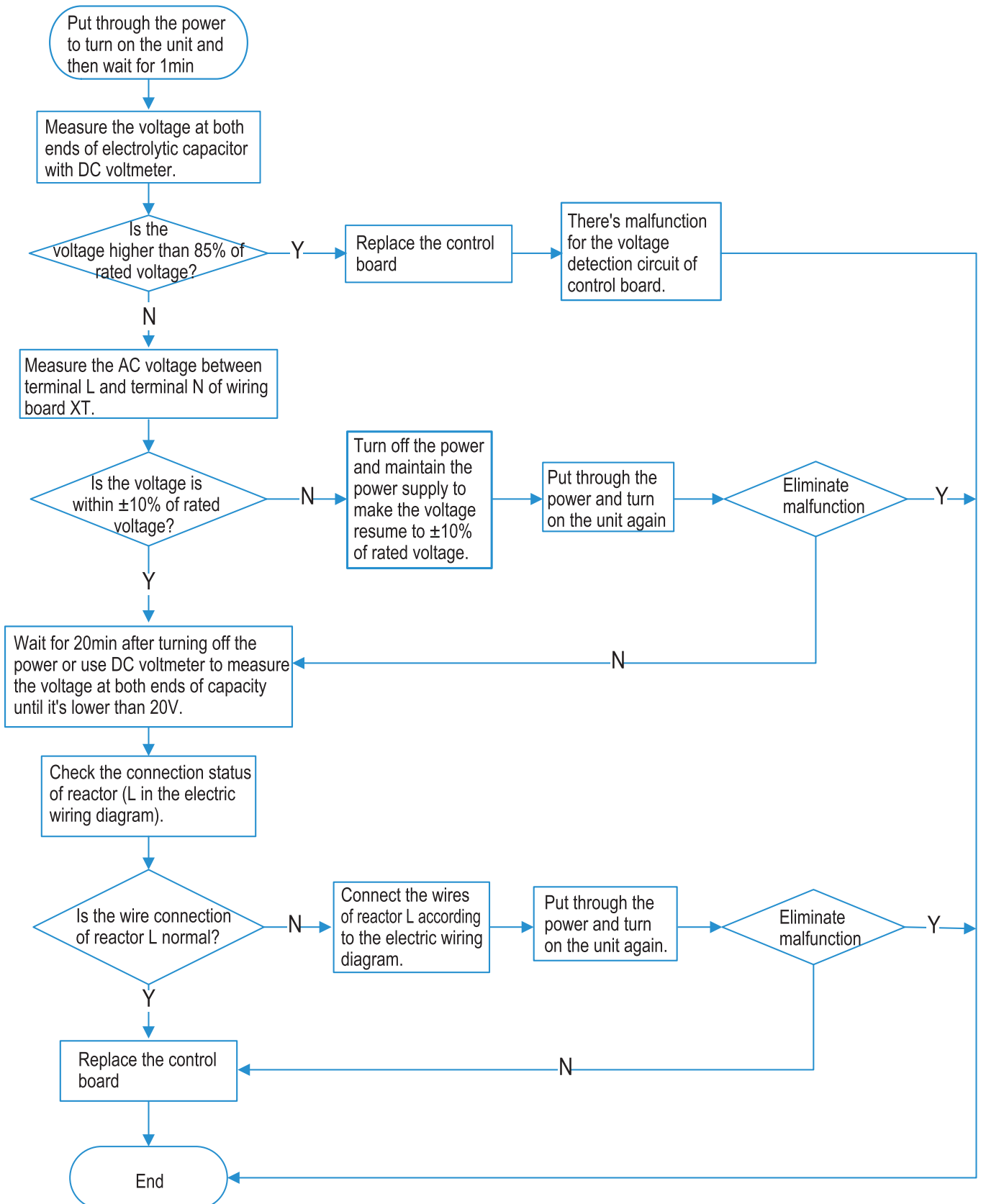

## 10. Troubleshooting-motor(indoor fan) doesn't operate H5

Main check points:

(1) connection terminal (2) motor (3) control board AP1 of indoor unit (4) blade

### 10.1 DC motor

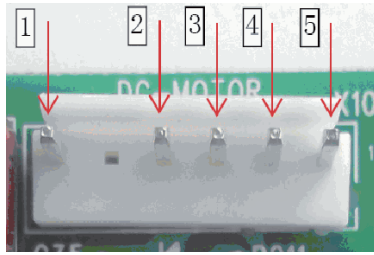
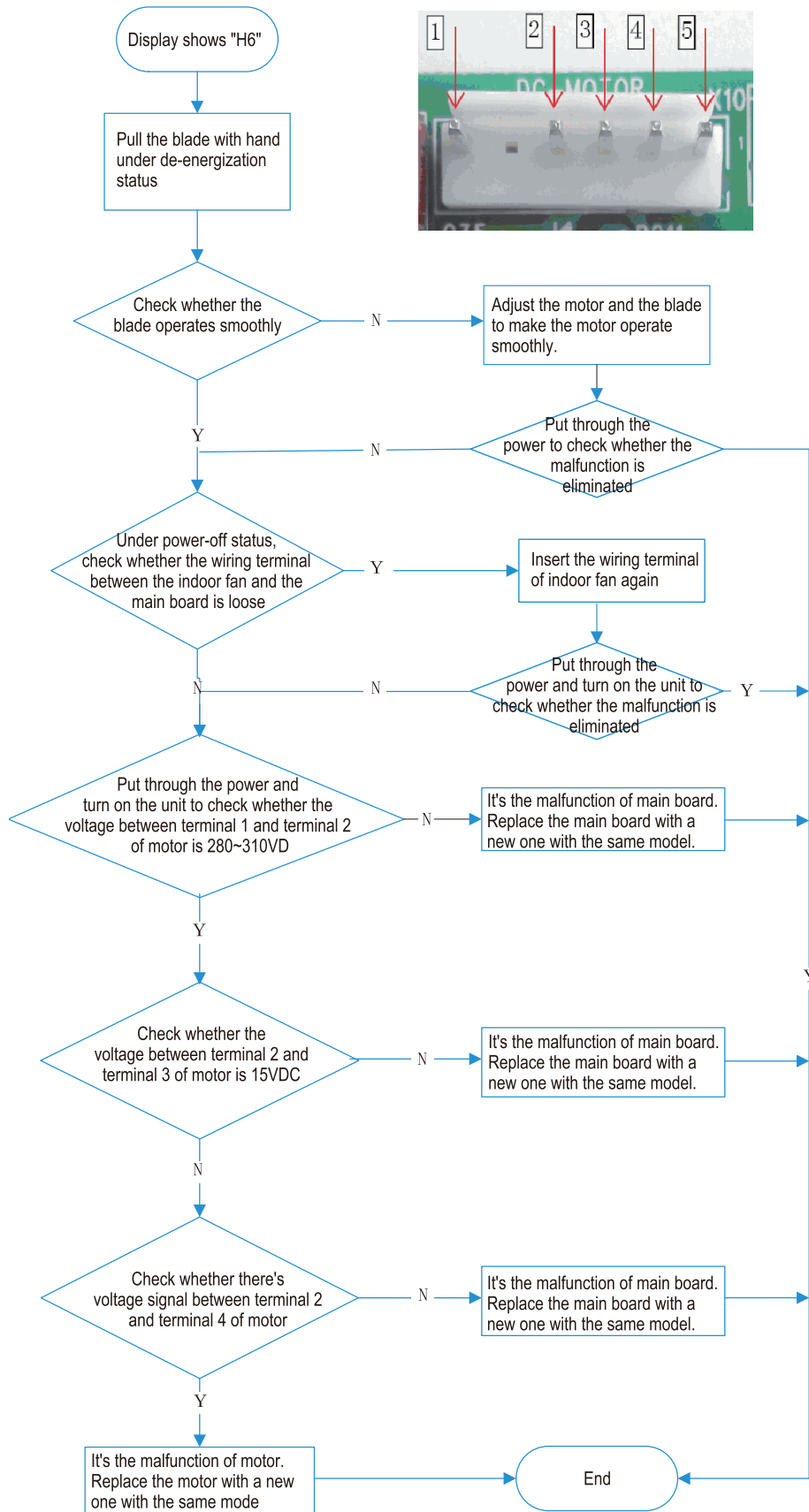



## 11. AC overcurrent protection E5

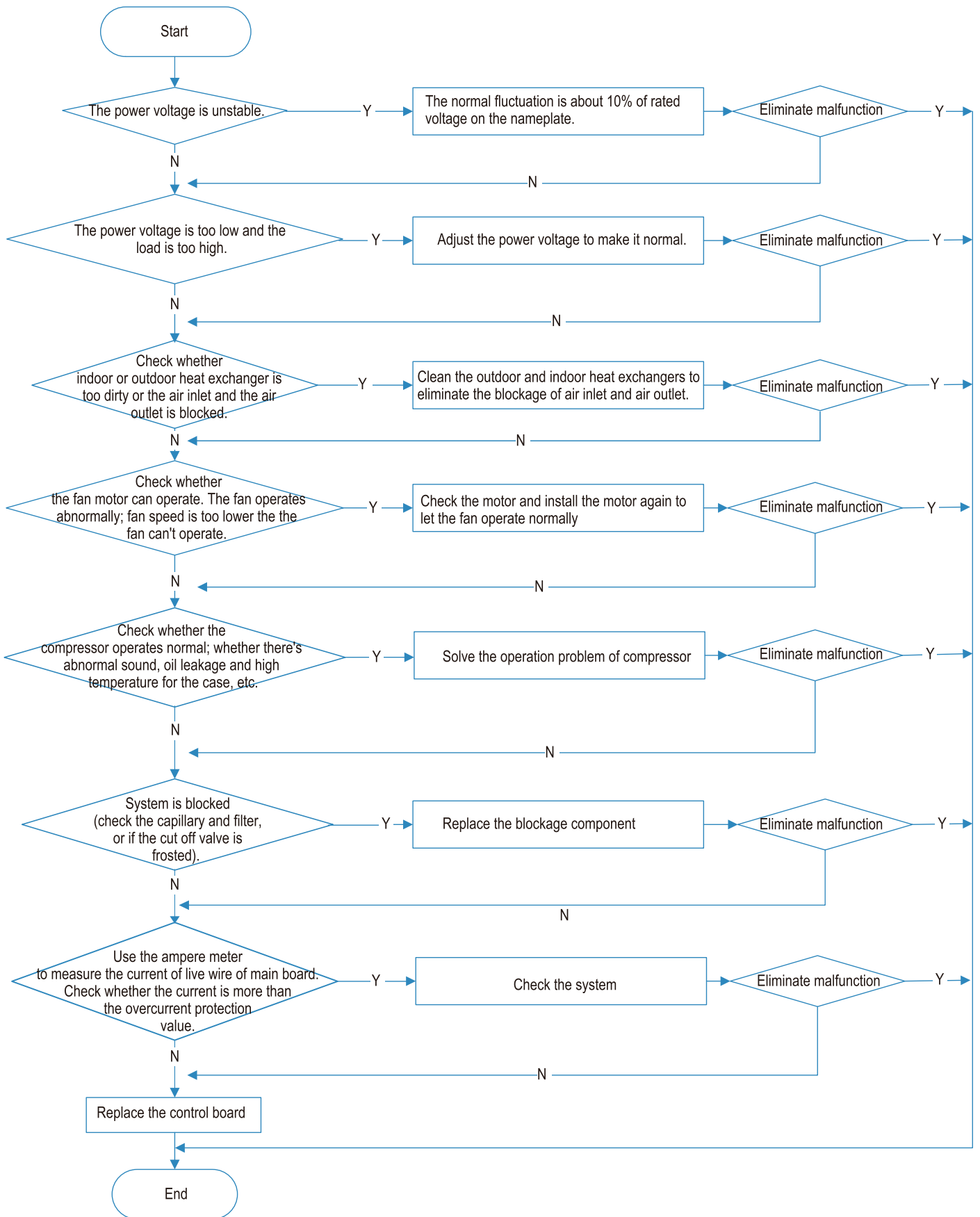

## 9.3 Troubleshooting for Normal Malfunction

### 1. Air Conditioner can't be Started Up

Possible Causes	Discriminating Method (Air conditioner Status)	Troubleshooting
No power supply, or poor connection for power plug	After energization, operation indicator isn't bright and the buzzer can't give out sound	Confirm whether it's due to power failure. If yes, wait for power recovery. If not, check power supply circuit and make sure the power plug is connected well.
Wrong wire connection between indoor unit and outdoor unit, or poor connection for wiring terminals	Under normal power supply circumstances, operation indicator isn't bright after energization	Check the circuit according to circuit diagram and connect wires correctly. Make sure all wiring terminals are connected firmly
Electric leakage for air conditioner	After energization, room circuit breaker trips off at once	Make sure the air conditioner is grounded reliably. Make sure wires of air conditioner is connected correctly. Check the wiring inside air conditioner. Check whether the insulation layer of power cord is damaged; if yes, place the power cord.
Model selection for air switch is improper	After energization, air switch trips off	Select proper air switch
Malfunction of remote controller	After energization, operation indicator is bright, while no display on remote controller or buttons have no action.	Replace batteries for remote controller Repair or replace remote controller

### 2. Poor Cooling (Heating) for Air Conditioner

Possible Causes	Discriminating Method (Air conditioner Status)	Troubleshooting
Set temperature is improper	Observe the set temperature on remote controller	Adjust the set temperature
Rotation speed of the IDU fan motor is set too low	Small wind blow	Set the fan speed at high or medium
Filter of indoor unit is blocked	Check the filter to see its blocked	Clean the filter
Installation position for indoor unit and outdoor unit is improper	Check whether the installation position is proper according to installation requirement for air conditioner	Adjust the installation position, and install the rain-proof and sunproof for outdoor unit
Refrigerant is leaking	Discharged air temperature during cooling is higher than normal discharged wind temperature; Discharged air temperature during heating is lower than normal discharged wind temperature; Units pressure is much lower than regulated range	Find out the leakage causes and deal with it. Add refrigerant.
Malfunction of 4-way valve	Blow cold wind during heating	Replace the 4-way valve
Malfunction of capillary	Discharged air temperature during cooling is higher than normal discharged wind temperature; Discharged air temperature during heating is lower than normal discharged wind temperature; Unit pressure is much lower than regulated range. If refrigerant isn't leaking, part of capillary is blocked	Replace the capillary
Flow volume of valve is insufficient	The pressure of valves is much lower than that stated in the specification	Open the valve completely
Malfunction of horizontal louver	Horizontal louver can't swing	Refer to point 3 of maintenance method for details
Malfunction of the IDU fan motor	The IDU fan motor can't operate	Refer to troubleshooting for H6 for maintenance method in details
Malfunction of the ODU fan motor	The ODU fan motor can't operate	Refer to point 4 of maintenance method for details
Malfunction of compressor	Compressor can't operate	Refer to point 5 of maintenance method for details

### 3. Horizontal Louver can't Swing

Possible Causes	Discriminating Method (Air conditioner Status)	Troubleshooting
Wrong wire connection, or poor connection	Check the wiring status according to circuit diagram	Connect wires according to wiring diagram to make sure all wiring terminals are connected firmly
Stepping motor is damaged	Stepping motor can't operate	Repair or replace stepping motor
Main board is damaged	Others are all normal, while horizontal louver can't operate	Replace the main board with the same model

#### 4. ODU Fan Motor can't Operate

Possible causes	Discriminating method (air conditioner status)	Troubleshooting
Wrong wire connection, or poor connection	Check the wiring status according to circuit diagram	Connect wires according to wiring diagram to make sure all wiring terminals are connected firmly
Capacity of the ODU fan motor is damaged	Measure the capacity of fan capacitor with an universal meter and find that the capacity is out of the deviation range indicated on the nameplate of fan capacitor.	Replace the capacity of fan
Power voltage is a little low or high	Use universal meter to measure the power supply voltage. The voltage is a little high or low	Suggest to equip with voltage regulator
Motor of outdoor unit is damaged	When unit is on, cooling/heating performance is bad and ODU compressor generates a lot of noise and heat.	Change compressor oil and refrigerant. If no better, replace the compressor with a new one

#### 5. Compressor can't Operate

Possible causes	Discriminating method (air conditioner status)	Troubleshooting
Wrong wire connection, or poor connection	Check the wiring status according to circuit diagram	Connect wires according to wiring diagram to make sure all wiring terminals are connected firmly
Capacity of compressor is damaged	Measure the capacity of fan capacitor with an universal meter and find that the capacity is out of the deviation range indicated on the nameplate of fan capacitor.	Replace the compressor capacitor
Power voltage is a little low or high	Use universal meter to measure the power supply voltage. The voltage is a little high or low	Suggest to equip with voltage regulator
Coil of compressor is burnt out	Use universal meter to measure the resistance between compressor terminals and it's 0	Repair or replace compressor
Cylinder of compressor is blocked	Compressor can't operate	Repair or replace compressor

#### 6. Air Conditioner is Leaking

Possible causes	Discriminating method (air conditioner status)	Troubleshooting
Drain pipe is blocked	Water leaking from indoor unit	Eliminate the foreign objects inside the drain pipe
Drain pipe is broken	Water leaking from drain pipe	Replace drain pipe
Wrapping is not tight	Water leaking from the pipe connection place of indoor unit	Wrap it again and bundle it tightly

#### 7. Abnormal Sound and Vibration

Possible causes	Discriminating method (air conditioner status)	Troubleshooting
When turn on or turn off the unit, the panel and other parts will expand and there's abnormal sound	There's the sound of "PAPA"	Normal phenomenon. Abnormal sound will disappear after a few minutes.
When turn on or turn off the unit, there's abnormal sound due to flow of refrigerant inside air conditioner	Water-running sound can be heard	Normal phenomenon. Abnormal sound will disappear after a few minutes.
Foreign objects inside the indoor unit or there are parts touching together inside the indoor unit	There's abnormal sound fro indoor unit	Remove foreign objects. Adjust all parts position of indoor unit, tighten screws and stick damping plaster between connected parts
Foreign objects inside the outdoor unit or there are parts touching together inside the outdoor unit	There's abnormal sound fro outdoor unit	Remove foreign objects. Adjust all parts position of outdoor unit, tighten screws and stick damping plaster between connected parts
Short circuit inside the magnetic coil	During heating, the way valve has abnormal electromagnetic sound	Replace magnetic coil
Abnormal shake of compressor	Outdoor unit gives out abnormal sound	Adjust the support foot mat of compressor, tighten the bolts
Abnormal sound inside the compressor	Abnormal sound inside the compressor	If add too much refrigerant during maintenance, please reduce refrigerant properly. Replace compressor for other circumstances.



# 10. Exploded View and Parts List

## 10.1 Indoor Unit

AVC

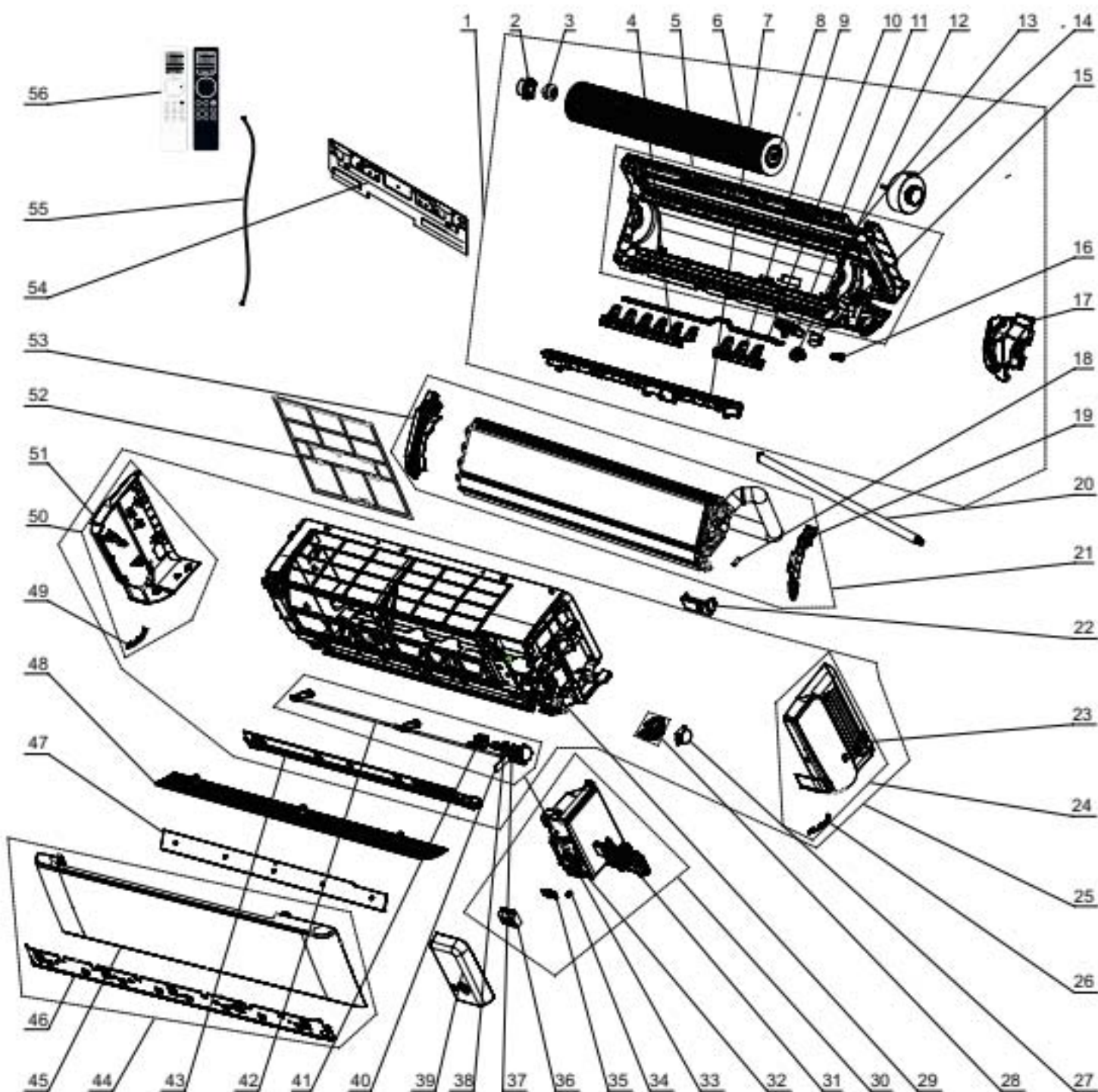

The component picture is only for reference; please refer to the actual product.

NO.	Description	NO.	Description
1	Rear Case assy	29	Front Case
2	Ring of Bearing	30	Electric Box Assy
3	O-Gasket sub-assy of Bearing	31	Display Board
4	Air Louver (Left)(Auto)	32	Electric Box Support
5	Rear Case Sub-assy	33	Connecting Rod Sub-assy
6	Cross Flow Fan	34	Jumper
7	Helicoid Tongue	35	Cable Clamp 2
8	Fan Bearing	36	Terminal Board
9	Air Louver(Right)	37	Stepping Motor
10	Swing Lever	38	Holder (Gear)
11	Plasma Bunch Ion	39	Electric Box Cover
12	Air Louver (Auto)(Single)	40	Transmission Rod Sub-assy
13	Connecting pipe clamp	41	Press plate (motor)
14	Brushless DC Motor	42	Lever (Air guide louver)
15	Stepping Motor	43	Seal Cover
16	Rubber Plug (Water Tray)	44	Front Panel Sub-assy
17	Motor Press Plate	45	Front Panel
18	Temp Sensor Sleeving	46	Decorative Board
19	Evaporator Right Border Plate	47	Top Cover
20	Drainage Hose	48	Guide Louver
21	Evaporator Assy	49	Decorative Strip (Left)
22	UV sterilizing lamp	50	Left Side Plate Sub-assy
23	Right Side Plate	51	Left Side Plate
24	Right Side Plate Sub-assy	52	Filter Sub-assy
25	Front Case Assy	53	Evaporator Support
26	Decorative Strip (Right)	54	Wall Mounting Frame
27	Stepping Motor	55	Connecting Cable
28	Gear Assy	56	Remote Controller

Some models may not contain some parts, please refer to the actual product.



NO.	Description	NO.	Description
1	Front Panel Assy	23	Brushless DC Motor
2	Filter Sub-assy	24	Motor Press Plate
3	Electric Box Cover	25	Connecting pipe clamp
4	Cable Clamp 2	26	Wall Mounting Frame
5	Supporter	27	Drainage Hose
6	Main Board	28	Evaporator Assy
7	Terminal Board	29	Cross Flow Fan
8	Display Board	30	UV sterilizing lamp
9	Electric Box	31	Evaporator Support
10	Top Cover	32	Axile Bush Sub-assy
11	Stepping Motor	33	Rear Case
12	Stepping Motor	34	Swing Lever
13	Gear parts	35	Air Louver (Auto)
14	Right Side Plate Sub-assy	36	Front Case
15	Guide Louver	37	Stepping Motor
16	Bottom Cover Plate	38	Connecting Rod Sub-assy
17	Helicoid Tongue	39	Stepping Motor
18	Air Louver (Auto)	40	Gear parts (left)
19	Air Louver	41	Left Side Plate Sub-assy
20	Stepping Motor	42	Remote Controller
21	Plasma Bunch Ion	43	Connecting Cable
22	Motor Holder 1	44	Power Cord

Some models may not contain some parts, please refer to the actual product.





NO.	Description	NO.	Description
1	Front Panel	22	Plasma Bunch Ion
2	Filter Sub-assy	23	Rear Case
3	Decorative Strip	24	Motor Press Plate
4	Top Cover	25	Brushless DC Motor
5	Stepping Motor	26	Evaporator Assy
6	Cable Clamp 2	27	Wall Mounting Frame
7	Terminal Board	28	Drainage Hose
8	Supporter	29	Evaporator Support (D7)
9	Jumper	30	UV sterilizing lamp
10	Main Board	31	O-Gasket Sub-assy of Bearing
11	Electric Box	32	Cross Flow Fan
12	Display Board	33	Left Side Plate Sub-assy
13	Stepping Motor	34	Stepping Motor
14	Gear Assy (right)	35	Gear Assy (left)
15	Right Side Plate Sub-assy	36	Bottom Cover Plate
16	Air Louver 1	37	Guide Louver
17	Air Louver	38	Stepping Motor
18	Air Louver 1	39	Connecting Rod Sub-assy
19	Swing Lever	40	Remote Controller
20	Stepping Motor	41	Connecting Cable
21	Helicoid Tongue	42	Power Cord

Some models may not contain some parts, please refer to the actual product.





NO.	Description	NO.	Description
1	Coping	15	Clapboard
2	Rear Grill	16	Motor Support
3	Condenser Assy	17	Brushless DC Motor
4	Right Side Plate	18	Cabinet
5	Electric Expand Valve Fitting	19	Front Grill
6	Electronic Expansion Valve	20	Axial Flow Fan
7	Handle	21	Left Side Plate
8	Valve Cover	22	Electric Box Assy
9	Cut-off valve Sub-assy	23	Electric Box
10	Cut-off valve	24	Main Board
11	Valve Support	25	Electric Box Cover
12	4-way valve assy	26	Terminal Board
13	Compressor and Fittings	27	Temperatue Sensor
14	Chassis Sub-assy	28	Radiator

Some models may not contain some parts, please refer to the actual product.

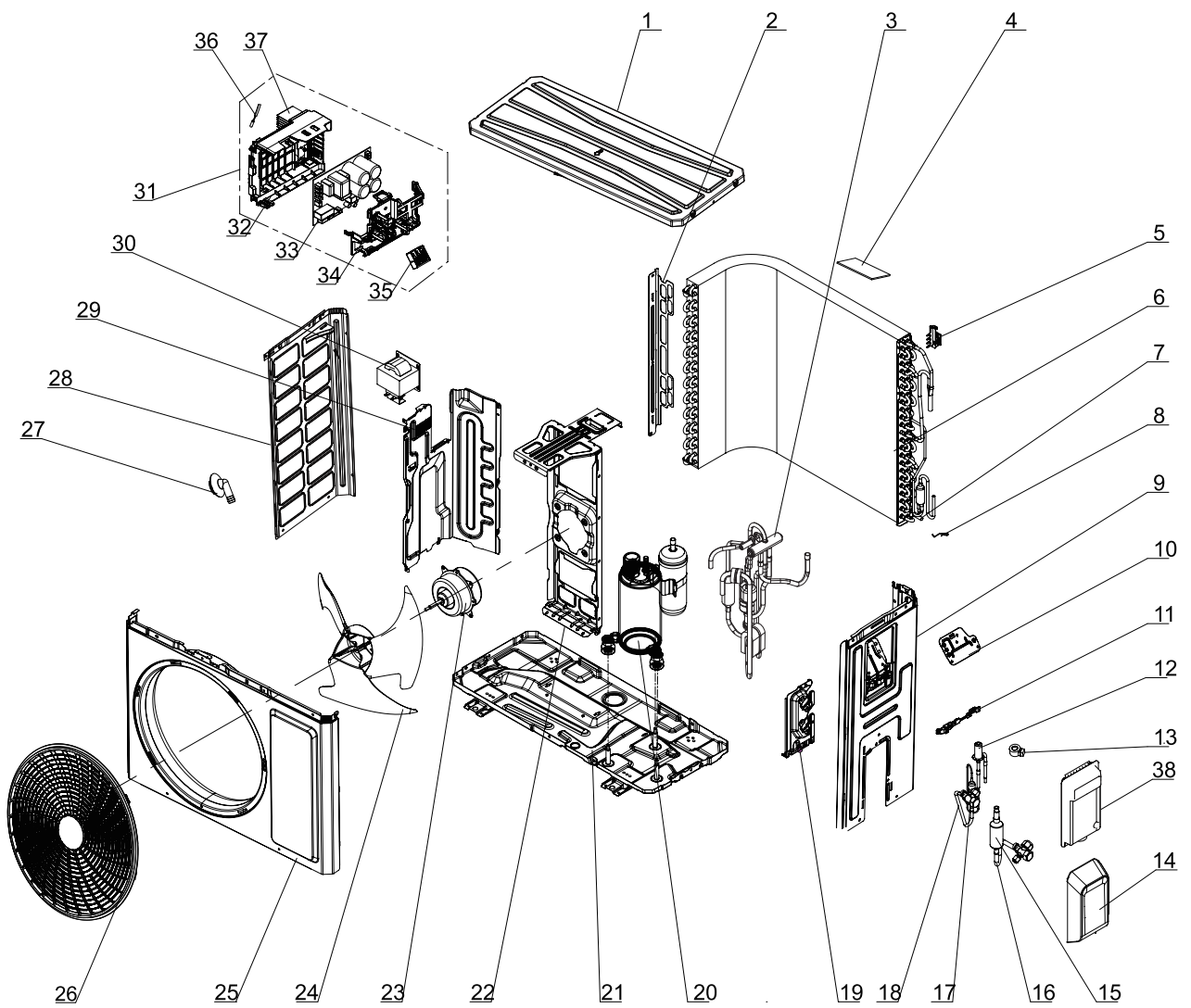

The component picture is only for reference; please refer to the actual product.

NO.	Description	NO.	Description
1	Top Cover Assy	20	Compressor and Fittings
2	Support Board (Condenser)	21	Chassis Sub-assy
3	4-way valve Assy	22	Motor Support
4	Sponge (Condenser)	23	Brushless DC Motor
5	Temperature Sensor Support	24	Axial Flow Fan
6	Condenser Assy	25	Cabinet
7	Temp Sensor Sleeving	26	Front Grill
8	Sensor Insert	27	Drainage Joint (ODU)
9	Right Side Plate	28	Left Side Plate
10	Earthing Plate Sub-assy	29	Clapboard
11	Wire Clamp	30	Reactor
12	Electric Expansion Valve Sub-assy	31	Electric Box Assy
13	Electric Expansion Valve Fitting	32	Electric Box
14	Valve Cover	33	Main Board
15	Silencer	34	Electric Box Cover
16	Cut off Valve Sub-assy	35	Terminal Board
17	Strainer	36	Temperature Sensor
18	Cut off Valve Assy	37	Radiator
19	Valve Support	38	Handle

Some models may not contain some parts, please refer to the actual product.



NO.	Description	NO.	Description
1	Front Panel Assy	19	Valve Cover
2	Front grill	20	Electronic Expand Valve Fitting
3	Front Panel	21	Sensor Insert
4	Axial Flow Fan	22	Temp Sensor Sleeving
5	Drainage hole Cap	23	Condenser Assy
6	Chassis Sub-assy	24	Clapboard Sub-assy
7	Drainage Joint	25	Motor Support Sub
8	Compressor and Fittings	26	Top Cover Sub-assy
9	Compressor Gasket	27	Left Side Plate
10	4-way valve	28	Terminal Board
11	4-way valve Sub-assy	29	Electric Box Cover
12	Electronic Expansion Valve	30	Main Board
13	Electronic Expansion Valve assy	31	Radiator
14	Right Side Plate Assy	32	Electric Box Assy
15	Valve Support	33	Electric Box
16	Cut-off valve	34	Brushless DC Motor
17	Cut-off valve	35	Handle
18	Valve Support Block		

Some models may not contain some parts, please refer to the actual product.





NO.	Description	NO.	Description
1	Front Grill	15	4-way valve Assy
2	Cabinet	16	Condenser Assy
3	Axial Flow Fan	17	Clapboard Assy
4	Chassis Sub-assy	18	Motor Support Sub-assy
5	Compressor and fittings	19	Brushless DC Motor
6	Electron expansion valve	20	Top Cover Assy
7	Electric Expand Valve Fitting	21	Left Side Plate
8	Right Side Plate Assy	22	Condenser Left Border Plate
9	Valve Support Sub-assy	23	Electric Box Assy
10	Cut-off Valve	24	Radiator
11	Cut-off Valve	25	Electric Box
12	Valve Cover	26	Main Board
13	Handle	27	Electric Box Cover
14	Terminal Board		

Some models may not contain some parts, please refer to the actual product.



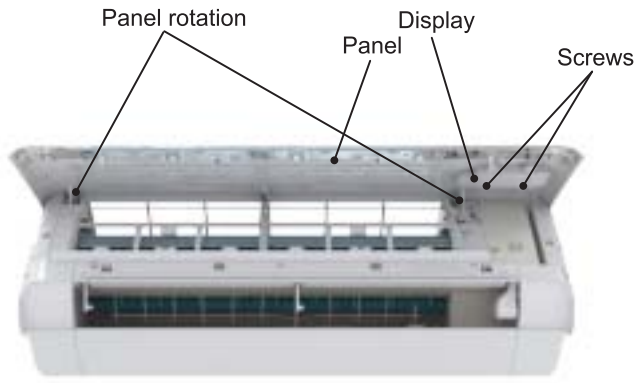
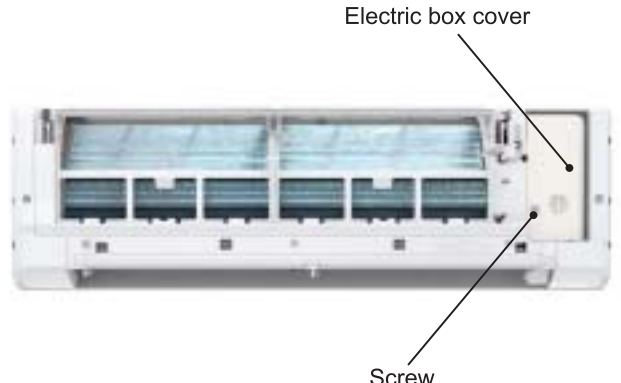
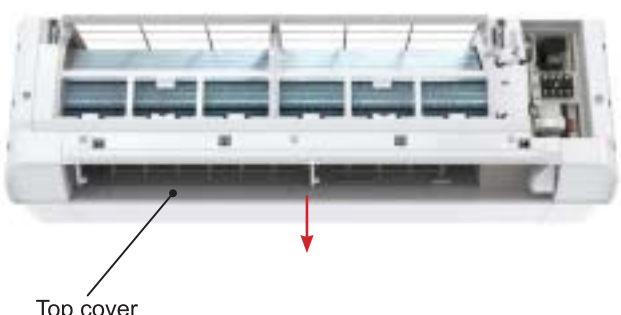

Step	Procedure
<p><b>3. Remove Panel</b></p> <p>Separate the panel rotation shaft from the groove fixing the front panel and then removes the front panel.</p> <p>Note: The display of some models is fixed on the panel; unscrew the screws fixing the display on the panel before removing the panel.</p>	 <p>The diagram shows a top-down view of the printer's front panel assembly. Four labels with leader lines point to specific components: 'Panel rotation' points to the shaft on the left side; 'Panel' points to the main front panel; 'Display' points to the LCD screen area; and 'Screws' points to the screws securing the display area.</p>
<p><b>4. Remove Electric Box Cover</b></p> <p>Remove the screw on the electric box cover to remove the electric box cover.</p>	 <p>The diagram shows a side view of the printer's front panel assembly. Two labels with leader lines point to components: 'Electric box cover' points to the cover on the right side of the panel; and 'Screw' points to the screw that secures the cover.</p>
<p><b>5. Remove Top Cover</b></p> <p>Push the top cover toward the arrow to remove the top cover.</p>	 <p>The diagram shows a front view of the printer's top cover assembly. A label 'Top cover' points to the cover itself. A red arrow points downwards from the center of the cover, indicating the direction in which it should be pushed to be removed.</p>

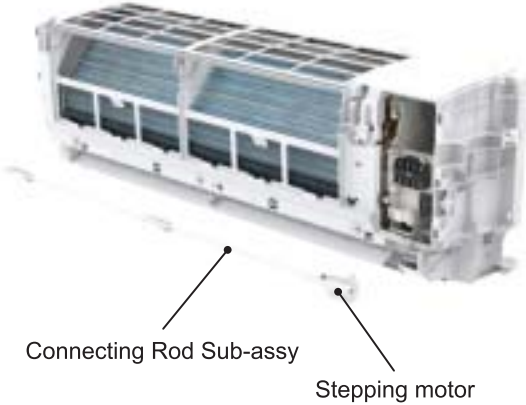
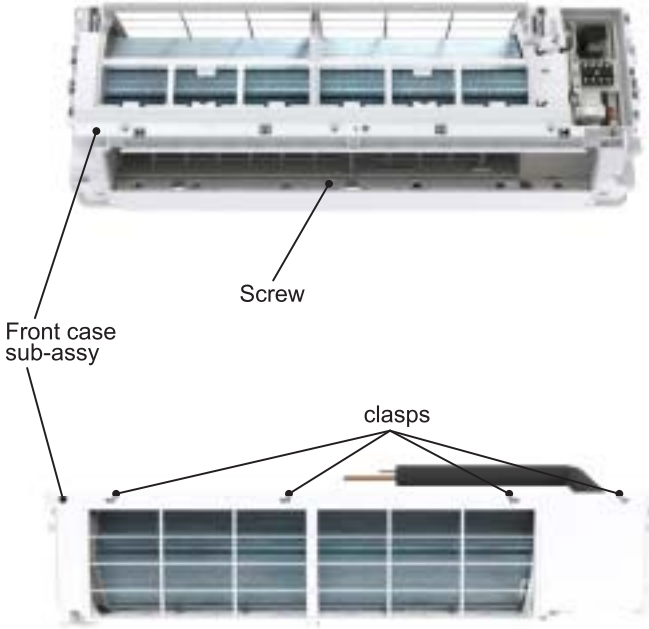
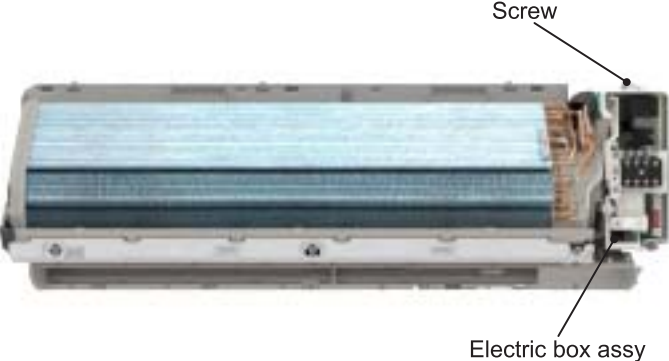

Step	Procedure	Image
<p><b>9. Remove Connecting Rod Sub-assy</b></p>	<p>Remove connecting rod sub-assy with stepping motor from clasps which are under seal cover.</p>	
<p><b>10. Remove Front Case Sub-assy</b></p>	<p>a Remove the screws fixing front case.</p> <p>b Loosen the 4 clasps of front case. Lift the front case sub-assy upwards to remove it.</p>	
<p><b>11. Remove Electric Box Assy</b></p>	<p>a Remove the screw fixing electric box assy.</p>	

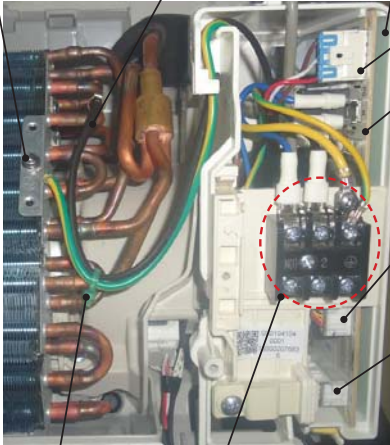
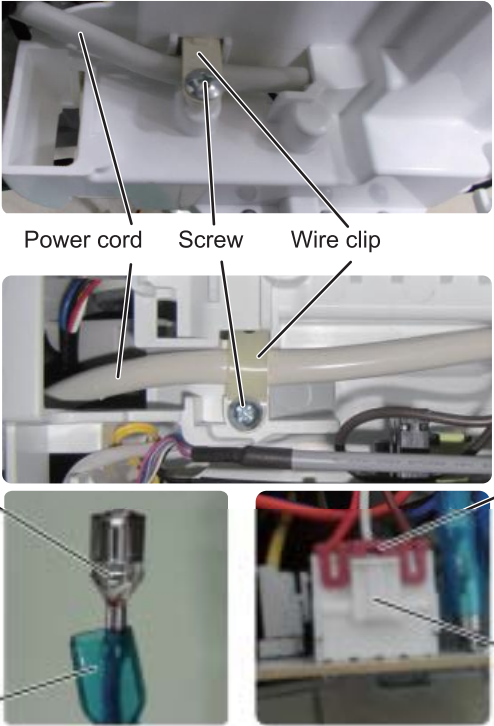

Step		Procedure
b	<p>① Cut off the wire binder and pull out the indoor tube temperature sensor.</p> <p>② Screw off one grounding screw.</p> <p>③ Remove the wiring terminals of motor, cold plasma generator and stepping motor.</p> <p>④ Remove the electric box assy.</p> <p>⑤ Screw off the screws that are locking each.</p>	 <p>Grounding screw</p> <p>Indoor tube temperature sensor</p> <p>Electric box assy</p> <p>Wiring terminal of motor</p> <p>Main board</p> <p>Wiring terminal of cold plasma generator</p> <p>Wiring terminal of stepping motor</p> <p>Wire binder</p> <p>Screws</p>
c	<p>Rotate the electric box assy. Twist off the screws that are locking the wire clip and loosen the power cord. Remove the wiring terminal of power cord. Lift up the main board and take it off.</p> <p>(NOTE: This step is only available to the unit which is indoor power supply.)</p> <p>Instruction:Some wiring terminal of this products is with lock catch and other devices.The pulling method is as below:</p> <p>1.Remove the soft sheath for some terminals <b>at first</b>, hold the circlip and then pull out the terminals.</p> <p>2.Pull out the holder for some terminals <b>at first</b>(holder is not available for some wiring terminal),hold the connector and then pull the terminal.</p>	 <p>AVA AVB AVC</p> <p>Power cord</p> <p>Screw</p> <p>Wire clip</p> <p>AVD AVE</p> <p>Circlip</p> <p>Holder</p> <p>Soft sheath</p> <p>Connector</p>
<b>12. Remove Evaporator Combination Assy</b>		
a	Remove 2 screws fixing evaporator combination assy.	 <p>Screws</p>

Step		Procedure
b	At the back of the unit, Loosen the clasp of the connecting pipe clamp and then remove the connection pipe clamp.	
c	First remove the left side of evaporator from the groove of bottom shell and then remove the right side from the clasp on the bottom shell.	
d	Adjust the position of connection pipe on evaporator slightly and then lift the evaporator upwards to remove it.	





## 11.2 Removal Procedure of Outdoor Unit

GWH09AVCXB-K6DNA1B/O



Caution: discharge the refrigerant completely before removal.

Step	Procedure
<b>1. Before disassembly</b>	 A photograph of the outdoor unit from a three-quarter front view, showing the fan grille and the service panel on the right side.
<b>2. Remove big handle and valve cover</b>	<p data-bbox="188 1173 775 1238">Remove the screws fixing big handle, valve cover and then remove them.</p>  A photograph of the outdoor unit with the 'Big handle' and 'Valve cover' removed. The removed parts are shown to the right of the unit with arrows pointing to their respective locations on the unit. Labels 'Big handle' and 'Valve cover' are present.
<b>3. Remove top cover</b>	<p data-bbox="188 1765 775 1830">Remove the screws fixing top panel and then remove the top panel.</p>  A photograph of the outdoor unit with the top cover removed. The top cover is shown above the unit, tilted upwards. A label 'Top cover' with an arrow points to the removed part.

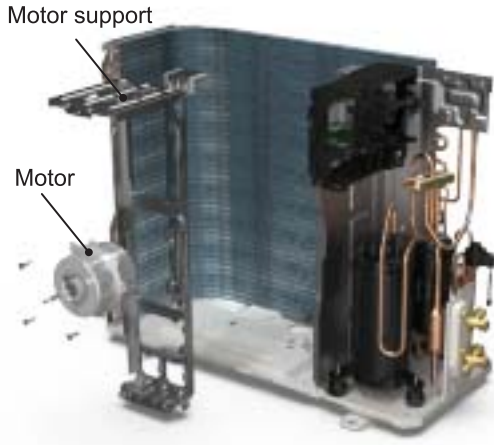
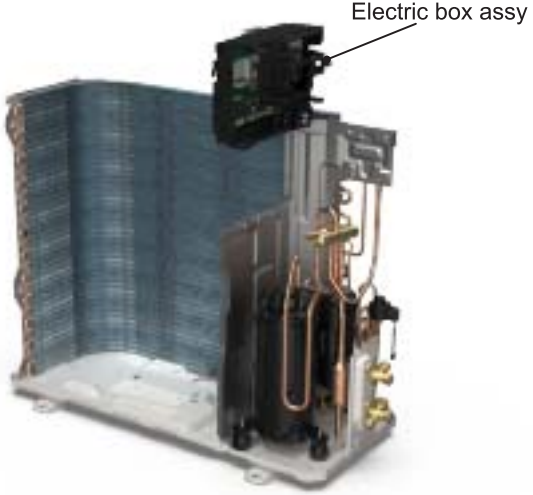
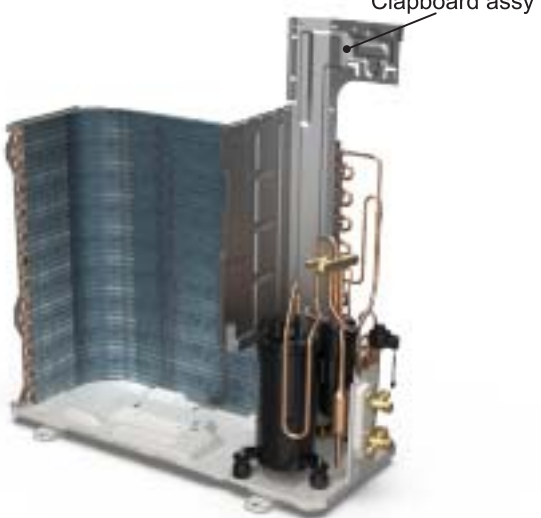

Step	Procedure
<p><b>7. Remove motor support and motor</b></p>	<p>Remove the screws fixing the motor support and lift the motor support to remove it. Remove the screws fixing the motor and then remove the motor.</p> 
<p><b>8. Remove electric box assy</b></p>	<p>Remove the terminals, lift up and rotate the electrical box assy to the right so that the snaps on the clapboard are removed and the electrical box assy are removed.</p> 
<p><b>9. Remove clapboard assy</b></p>	<p>Remove the screws fixing the clapboard assy and then remove the clapboard assy.</p> 



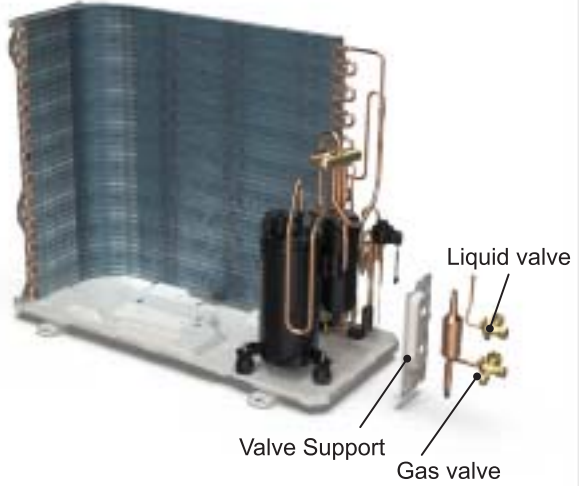
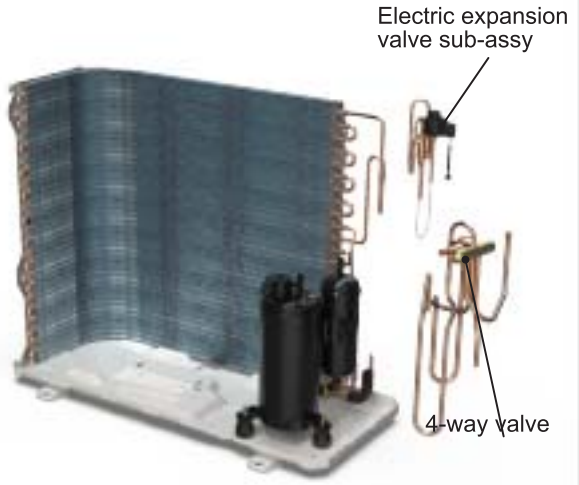
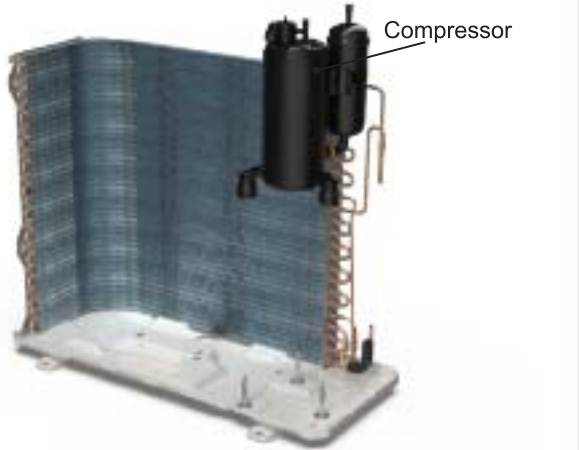



Step	Procedure
<p><b>10. Remove gas valve and liquid valve</b></p> <p>Remove the valve support block, remove the screws fixing the gas valve and the liquid valve, unsolder the welding joint connecting the gas valve and the liquid valve, remove them.</p> <p>Note: Discharge the refrigerant completely before unsoldering; when unsoldering, wrap the gas valve with a wet cloth completely to avoid damage to the valve caused by high temperature.</p>	 <p>The diagram shows a condenser coil on a base. A valve support block is positioned to the right. A gas valve and a liquid valve are attached to the support block. Labels with arrows point to the 'Valve Support', 'Gas valve', and 'Liquid valve'.</p>
<p><b>11. Remove 4-way valve and electric expansion valve sub-assy</b></p> <p>Unsolder the welding joints connecting the 4-way valve assembly, remove the 4-way valve.</p> <p>Unsolder the spot weld of electric expansion valve sub-assembly and condenser, and then remove the electric expansion valve sub-assembly.</p> <p>Note: Before unsoldering the welding joint, wrap the 4-way valve with a wet cloth completely to avoid damage to the valve caused by high temperature. When unsoldering the spot weld, wrap the electric expansion valve sub-assembly with wet cloth completely to avoid damaging the valve due to high temperature.</p>	 <p>The diagram shows the condenser coil with the 4-way valve and electric expansion valve sub-assembly removed. Labels with arrows point to the 'Electric expansion valve sub-assy' and the '4-way valve'.</p>
<p><b>12. Remove compressor</b></p> <p>Remove the 3 foot nuts on the compressor and then remove the compressor.</p>	 <p>The diagram shows the condenser coil with the compressor removed. A label with an arrow points to the 'Compressor'.</p>

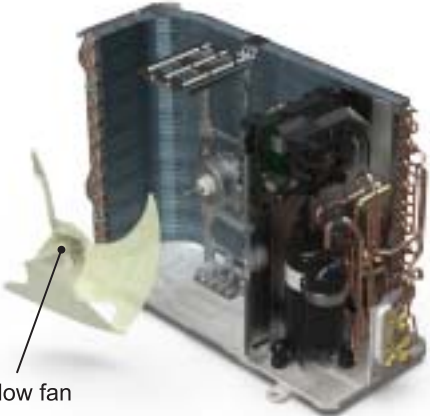

**Caution: discharge the refrigerant completely before removal.**

Step	Procedure
<b>1. Before disassembly</b>	
<b>2. Remove big handle and valve cover</b>	<p>Remove the screws fixing big handle, valve cover and then remove them.</p> 
<b>3. Remove top cover</b>	<p>Remove the screws fixing top panel and then remove the top panel.</p> 

Step	Procedure
<p><b>4. Remove front panel assy</b></p>	<p>Remove connection screws connecting the front panel assy with the chassis and the motor support, and then remove the front panel assy.</p> 
<p><b>5. Remove right side plate assy</b></p>	<p>Rescrew the ground screws, remove the ground wires, loosen the screws fixing terminal board, remove the terminal board, rescrew the screws fixing the right plate, and remove the right side plate assy.</p> 
<p><b>6. Remove axial flow fan</b></p>	<p>Remove the nut on the fan and then remove the axial flow fan.</p> 

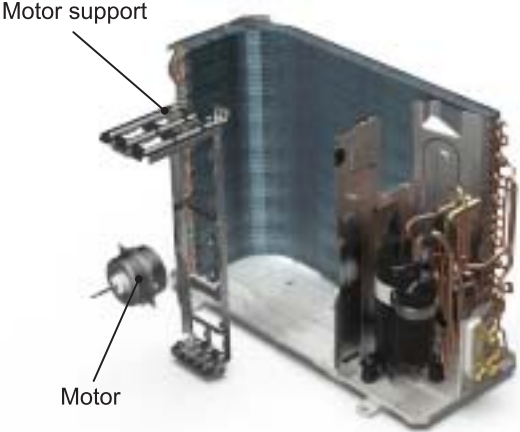
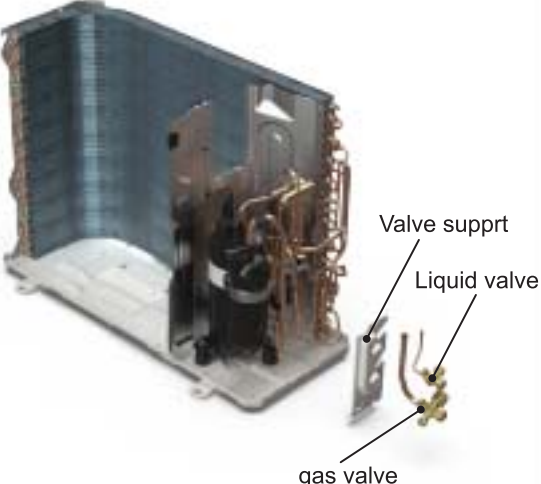

Step	Procedure
<p><b>7. Remove electric box assy</b></p>	<p>Remove the terminals, lift up and rotate the electrical box assy to the right so that the snaps on the clapboard are removed and the electrical box assy are removed.</p>  <p>Electric box assy</p>
<p><b>8. Remove motor and motor support</b></p>	<p>Remove the screws fixing the motor and then remove the motor. Remove the screws fixing the motor support and lift the motor support to remove it.</p>  <p>Motor support</p> <p>Motor</p>
<p><b>9. Remove gas valve, liquid valve and valve support</b></p>	<p>Remove the valve support block, remove the screws fixing the gas valve and the liquid valve, unsolder the welding joint connecting the gas valve and the liquid valve, remove them.</p> <p>Note: Discharge the refrigerant completely before unsoldering; when unsoldering, wrap the gas valve with a wet cloth completely to avoid damage to the valve caused by high temperature.</p> <p>Remove the screws fixing valve support, then remove the valve support.</p>  <p>Valve support</p> <p>Liquid valve</p> <p>gas valve</p>

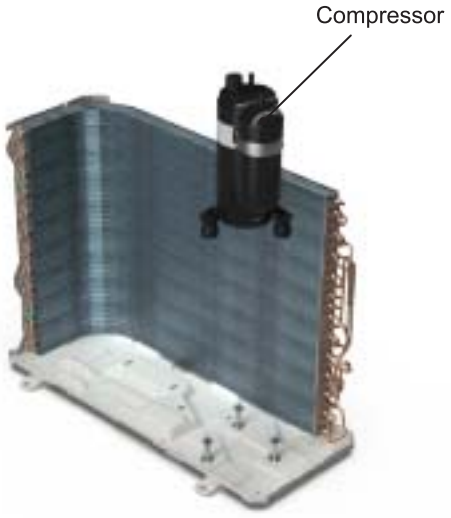







Step	Procedure
<b>13. Remove compressor</b>	 <p data-bbox="188 568 774 629">Remove the 3 foot nuts on the compressor and then remove the compressor.</p>







Step	Procedure
<p><b>4. Remove top cover</b></p> <p>Remove connection screws connecting the top panel with the front panel and the right side plate, and then remove the top panel.</p>	 <p>top cover</p>
<p><b>5. Remove grille</b></p> <p>Remove connection screws between the front grille and the front panel. Then remove the grille.</p>	 <p>grille</p>
<p><b>6. Remove front panel</b></p> <p>Remove connection screws connecting the front panel with the chassis and the motor support and then remove the front panel.</p>	 <p>front panel</p>

Step	Procedure
<p><b>7. Remove right side plate</b></p>	<p>Remove connection screws connecting the right side plate with the valve support and the electric box. Then remove the right side plate.</p> 
<p><b>8. Remove the nut and gasket on the blade and then remove the axial flow blade</b></p>	<p>Remove the nut and gasket on the blade and then remove the axial flow blade.</p> 
<p><b>9. Remove motor and motor support</b></p>	<p>Remove the tapping screws fixing the motor and disconnect the leading wire insert of the motor. Then remove the motor.</p> <p>Remove the tapping screws fixing the motor support and lift the motor support to remove it.</p> 

Step	Procedure
<p><b>10. Remove Electric Box Assy</b></p>	<p>Remove screws fixing the electric box subassembly; loosen the wire bundle and unplug the wiring terminals. Then lift the electric box to remove it.</p> 
<p><b>11. Remove isolation sheet</b></p>	<p>Remove the screws fixing the isolation sheet and then remove the isolation sheet.</p> 
<p><b>12. Remove cut-off valve</b></p>	<p>Unsolder the welding joints connecting the liquid valve and gas valve, and then remove them.</p> <p>Note: Before unsoldering the welding joint, wrap the cut-off valve with a wet cloth completely to avoid damage to the valve caused by high temperature.</p> 



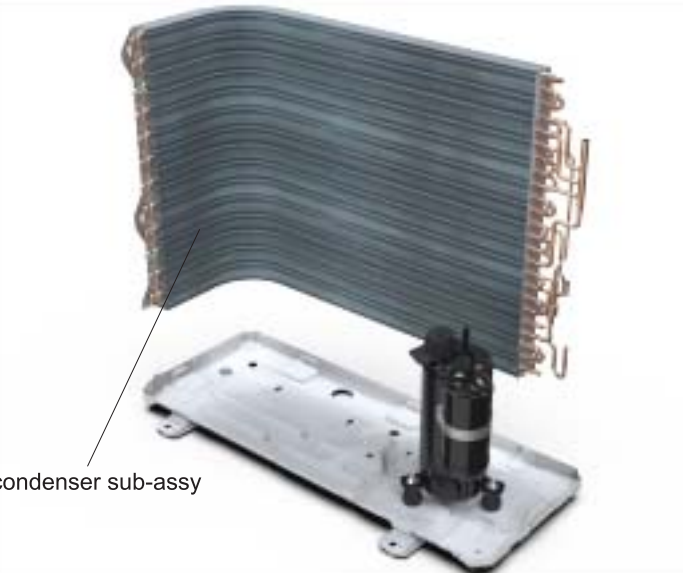

Step	Procedure
<p><b>16. Remove left side plate</b></p>	<p>Remove the screws fixing the left side plate and then remove the left side plate.</p> 
<p><b>17. Remove condenser sub-assy</b></p>	<p>Remove the screws fixing the Remove condenser sub-assy and then remove the Remove condenser sub-assy.</p> 
<p><b>18. Remove compressor</b></p>	<p>Remove the 3 foot nuts on the compressor and then remove the compressor.</p> 



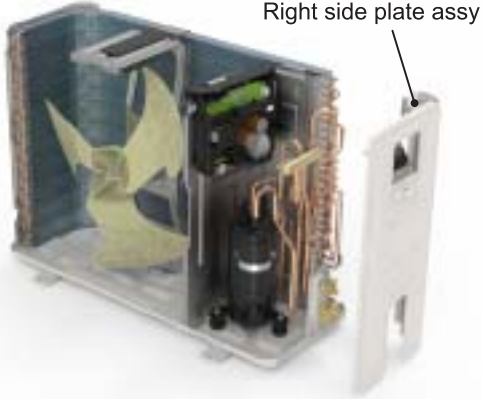
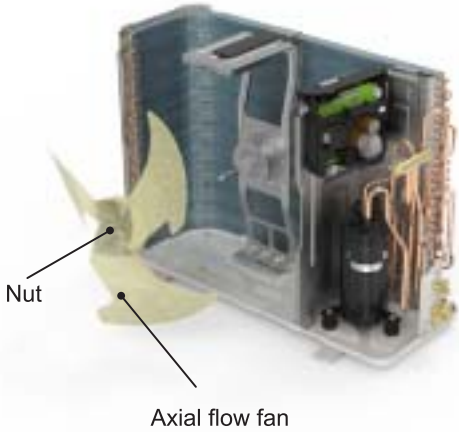

Step	Procedure
<p><b>4. Remove front panel assy</b></p>	<p>Remove connection screws connecting the front panel assy with the chassis and the motor support, and then remove the front panel assy.</p> 
<p><b>5. Remove right side plate assy</b></p>	<p>Rescrew the ground screws, remove the ground wires, loosen the screws fixing terminal board, remove the terminal board, rescrew the screws fixing the right plate, and remove the right side plate assy.</p> 
<p><b>6. Remove axial flow fan</b></p>	<p>Remove the nut on the fan and then remove the axial flow fan.</p> 

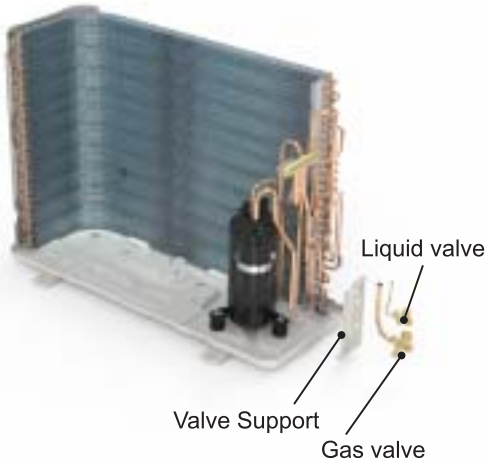
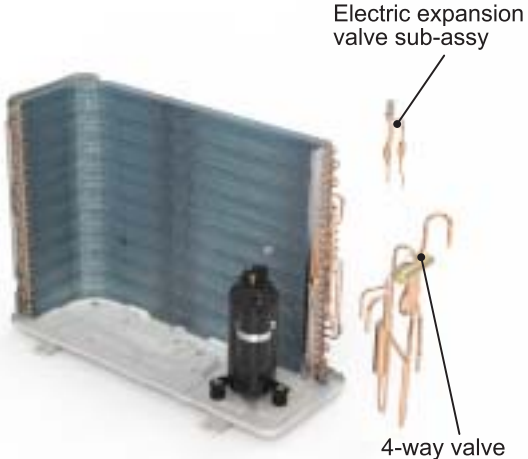
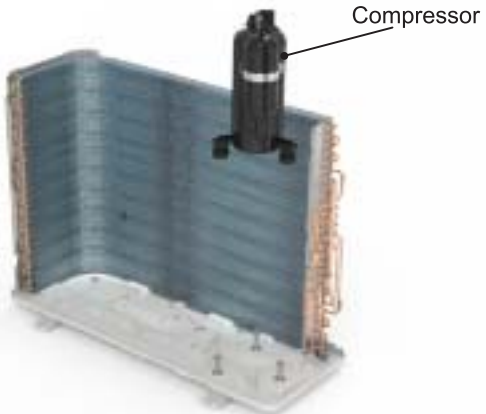

Step	Procedure
<p><b>10. Remove gas valve and liquid valve</b></p> <p>Remove the valve support block, remove the screws fixing the gas valve and the liquid valve, unsolder the welding joint connecting the gas valve and the liquid valve, remove them.</p> <p>Note: Discharge the refrigerant completely before unsoldering; when unsoldering, wrap the gas valve with a wet cloth completely to avoid damage to the valve caused by high temperature.</p>	 <p>The diagram shows a 3D perspective of the AC unit's internal components. A black valve support block is mounted on a base. A gas valve and a liquid valve are connected to the support block. Labels with arrows point to the 'Valve Support', 'Gas valve', and 'Liquid valve'.</p>
<p><b>11. Remove 4-way valve and electric expansion valve sub-assy</b></p> <p>Unsolder the welding joints connecting the 4-way valve assembly, remove the 4-way valve.</p> <p>Unsolder the spot weld of electric expansion valve sub-assembly and condenser, and then remove the electric expansion valve sub-assembly.</p> <p>Note: Before unsoldering the welding joint, wrap the 4-way valve with a wet cloth completely to avoid damage to the valve caused by high temperature. When unsoldering the spot weld, wrap the electric expansion valve sub-assembly with wet cloth completely to avoid damaging the valve due to high temperature.</p>	 <p>The diagram shows the internal components of the AC unit. The 4-way valve and electric expansion valve sub-assembly are highlighted. Labels with arrows point to the 'Electric expansion valve sub-assy' and the '4-way valve'.</p>
<p><b>12. Remove compressor</b></p> <p>Remove the 3 foot nuts on the compressor and then remove the compressor.</p>	 <p>The diagram shows the internal components of the AC unit. The compressor is highlighted. A label with an arrow points to the 'Compressor'.</p>

# Appendix:

## Appendix 1: Reference Sheet of Celsius and Fahrenheit

Conversion formula for Fahrenheit degree and Celsius degree:  $T_f = T_c \times 1.8 + 32$

### Set temperature

Fahrenheit display temperature (°F)	Fahrenheit (°F)	Celsius (°C)	Fahrenheit display temperature (°F)	Fahrenheit (°F)	Celsius (°C)	Fahrenheit display temperature (°F)	Fahrenheit (°F)	Celsius (°C)
61	60.8	16	69/70	69.8	21	78/79	78.8	26
62/63	62.6	17	71/72	71.6	22	80/81	80.6	27
64/65	64.4	18	73/74	73.4	23	82/83	82.4	28
66/67	66.2	19	75/76	75.2	24	84/85	84.2	29
68	68	20	77	77	25	86	86	30

### Ambient temperature

Fahrenheit display temperature (°F)	Fahrenheit (°F)	Celsius (°C)	Fahrenheit display temperature (°F)	Fahrenheit (°F)	Celsius (°C)	Fahrenheit display temperature (°F)	Fahrenheit (°F)	Celsius (°C)
32/33	32	0	55/56	55.4	13	79/80	78.8	26
34/35	33.8	1	57/58	57.2	14	81	80.6	27
36	35.6	2	59/60	59	15	82/83	82.4	28
37/38	37.4	3	61/62	60.8	16	84/85	84.2	29
39/40	39.2	4	63	62.6	17	86/87	86	30
41/42	41	5	64/65	64.4	18	88/89	87.8	31
43/44	42.8	6	66/67	66.2	19	90	89.6	32
45	44.6	7	68/69	68	20	91/92	91.4	33
46/47	46.4	8	70/71	69.8	21	93/94	93.2	34
48/49	48.2	9	72	71.6	22	95/96	95	35
50/51	50	10	73/74	73.4	23	97/98	96.8	36
52/53	51.8	11	75/76	75.2	24	99	98.6	37
54	53.6	12	77/78	77	25			

## Appendix 2: Configuration of Connection Pipe

- Standard length of connection pipe (More details please refer to the specifications.)
- Min. length of connection pipe for the unit with standard connection pipe of 5m, there is no limitation for the min. length of connection pipe. For the unit with standard connection pipe of 7.5m and 8m, the min. length of connection pipe is 3m.
- Max. length of connection pipe and max. high difference. (More details please refer to the specifications.)
- The additional refrigerant oil and refrigerant charging required after prolonging connection pipe
  - After the length of connection pipe is prolonged for 10m at the basis of standard length, you should add 5ml of refrigerant oil for each additional 5m of connection pipe.
  - The calculation method of additional refrigerant charging amount (on the basis of liquid pipe):
  - Basing on the length of standard pipe, add refrigerant according to the requirement as shown in the table. The additional refrigerant charging amount per meter is different according to the diameter of liquid pipe. See the following sheet.
  - Additional refrigerant charging amount = prolonged length of liquid pipe X additional refrigerant charging amount per meter.

Additional refrigerant charging amount for R32

Piping size		Indoor unit throttle	Outdoor unit throttle	
Liquid pipe	Gas pipe	Cooling only, cooling and heating (g / m)	Cooling only(g/m)	Cooling and heating(g/m)
1/4"	3/8" or 1/2"	14	12	16
1/4" or 3/8"	5/8" or 3/4"	40	12	40
1/2"	3/4" or 7/8"	80	24	96
5/8"	1" or 1 1/4"	136	48	96
3/4"	/	200	200	200
7/8"	/	280	280	280

## Appendix 3: Pipe Expanding Method

### ⚠ Note:

Improper pipe expanding is the main cause of refrigerant leakage. Please expand the pipe according to the following steps:

#### A: Cut the pip

- Confirm the pipe length according to the distance of indoor unit and outdoor unit.
- Cut the required pipe with pipe cutter.

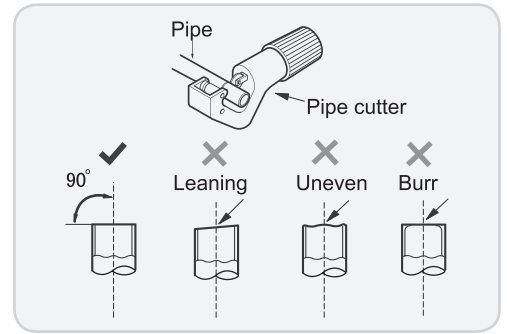

#### B: Remove the burrs

- Remove the burrs with shaper and prevent the burrs from getting into the pipe.

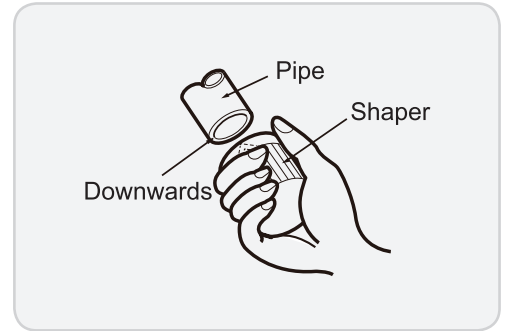

#### C: Put on suitable insulating pipe.

#### D: Put on the union nut

- Remove the union nut on the indoor connection pipe and outdoor valve; install the union nut on the pipe.

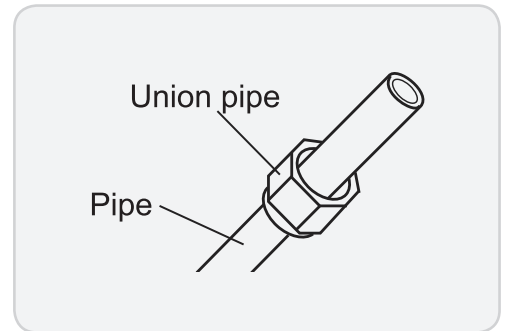

#### E: Expand the port

- Expand the port with expander.

### ⚠ Note:

- "A" is different according to the diameter, please refer to the sheet below:

Outer diameter(mm)	A(mm)	
	Max	Min
Φ6 - 6.35 (1/4")	1.3	0.7
Φ9.52 (3/8")	1.6	1.0
Φ12 - 12.70 (1/2")	1.8	1.0
Φ16 - 15.88 (5/8")	2.4	2.2

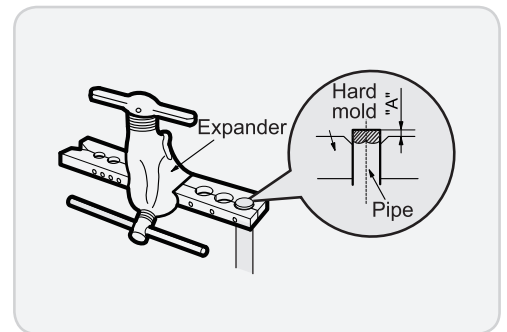

#### F: Inspection

- Check the quality of expanding port. If there is any blemish, expand the port again according to the steps above.

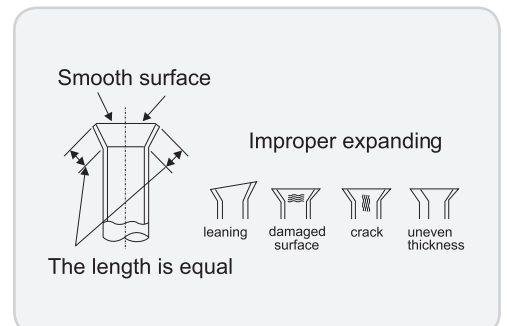







JF00305350



GREE ELECTRIC APPLIANCES, INC. OF ZHUHAI

Add: West Jinji Rd, Qianshan, Zhuhai, Guangdong, China, 519070

Tel: (+86-756) 8522219

Fax: (+86-756) 8669426

E-mail: [global@cn.gree.com](mailto:global@cn.gree.com)

**For product improvement, specifications and appearance in this manual are subject to change without prior notice.**