

SERVICE MANUAL

R410A

[Model Name]	[Service Ref.]	
PUHZ-SHW80VHA	PUHZ-SHW80VHA	PUHZ-SHW80VHAR2.UK
	PUHZ-SHW80VHAR3.UK	PUHZ-SHW80VHAR4.UK
PUHZ-SHW112VHA	PUHZ-SHW112VHA	PUHZ-SHW112VHAR2.UK
	PUHZ-SHW112VHAR3.UK	PUHZ-SHW112VHAR4.UK
PUHZ-SHW112YHA	PUHZ-SHW112YHA	PUHZ-SHW112YHAR1
	PUHZ-SHW112YHAR2.UK	PUHZ-SHW112YHAR3.UK
	PUHZ-SHW112YHAR4.UK	
PUHZ-SHW140YHA	PUHZ-SHW140YHA	PUHZ-SHW140YHAR1
	PUHZ-SHW140YHAR2.UK	PUHZ-SHW140YHAR3.UK
	PUHZ-SHW140YHAR4.UK	PUHZ-SHW140YHAR5.UK
Salt proof model		
PUHZ-SHW80VHA-BS	PUHZ-SHW80VHAR2-BS.UK	PUHZ-SHW80VHAR3-BS.UK
	PUHZ-SHW80VHAR4-BS.UK	
PUHZ-SHW112VHA-BS	PUHZ-SHW112VHAR2-BS.UK	PUHZ-SHW112VHAR3-BS.UK
	PUHZ-SHW112VHAR4-BS.UK	
PUHZ-SHW112YHA-BS	PUHZ-SHW112YHAR2-BS.UK	PUHZ-SHW112YHAR3-BS.UK
	PUHZ-SHW112YHAR4-BS.UK	
PUHZ-SHW140YHA-BS	PUHZ-SHW140YHAR2-BS.UK	PUHZ-SHW140YHAR3-BS.UK
	PUHZ-SHW140YHAR4-BS.UK	PUHZ-SHW140YHAR5-BS.UK

Revision:

- Added
PUHZ-SHW140YHAR5.UK,
and
PUHZ-SHW140YHAR5-BS.UK
in REVISED EDITION-E.

- Some descriptions have
been modified.

- OCH526 REVISED EDITION-D
is void.

Note:

- This manual describes
service data of the outdoor
units only.

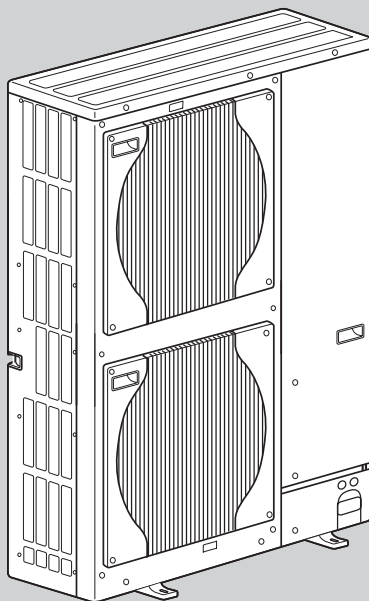

CONTENTS

1. TECHNICAL CHANGES.....	2
2. REFERENCE MANUAL.....	3
3. SAFETY PRECAUTION	5
4. SPECIFICATIONS	9
5. DATA	11
6. OUTLINES AND DIMENSIONS.....	13
7. WIRING DIAGRAM.....	15
8. WIRING SPECIFICATIONS	22
9. REFRIGERANT SYSTEM DIAGRAM	23
10. TROUBLESHOOTING.....	25
11. FUNCTION SETTING	94
12. MONITORING THE OPERATION DATA BY THE REMOTE CONTROLLER ..	106
13. EASY MAINTENANCE FUNCTION	117
14. DISASSEMBLY PROCEDURE.....	124

PARTS CATALOG (OCB526)

Service ref. have been changed as follows.

PUHZ-SHW140YHAR4(-BS).UK → PUHZ-SHW140YHAR5(-BS).UK

• A compliance with ErP directive Lot6 has been authorized.

PUHZ-SHW80VHAR3(-BS).UK → PUHZ-SHW80VHAR4(-BS).UK

PUHZ-SHW112VHAR3(-BS).UK → PUHZ-SHW112VHAR4(-BS).UK

PUHZ-SHW112YHAR3(-BS).UK → PUHZ-SHW112YHAR4(-BS).UK

PUHZ-SHW140YHAR3(-BS).UK → PUHZ-SHW140YHAR4(-BS).UK

• A compliance with ErP directive Lot1 has been authorized.

• All circuit boards (C.B./P.B./N.F./CONV.B) have been changed (including a change of production site).

PUHZ-SHW80VHAR2(-BS).UK → PUHZ-SHW80VHAR3(-BS).UK

PUHZ-SHW112VHAR2(-BS).UK → PUHZ-SHW112VHAR3(-BS).UK

PUHZ-SHW112YHAR2(-BS).UK → PUHZ-SHW112YHAR3(-BS).UK

PUHZ-SHW140YHAR2(-BS).UK → PUHZ-SHW140YHAR3(-BS).UK

• Added a new function "Energy Monitor" which allows remote controller to display power consumption and heat output.

PUHZ-SHW80VHA → PUHZ-SHW80VHAR2(-BS).UK

PUHZ-SHW112VHA → PUHZ-SHW112VHAR2(-BS).UK

PUHZ-SHW112YHAR1 → PUHZ-SHW112YHAR2(-BS).UK

PUHZ-SHW140YHAR1 → PUHZ-SHW140YHAR2(-BS).UK

• Controller circuit board (C.B.) has been changed.

PUHZ-SHW112YHA → PUHZ-SHW112YHAR1

PUHZ-SHW140YHA → PUHZ-SHW140YHAR1

• Power circuit board (P.B.) has been changed.

INDOOR UNIT SERVICE MANUAL
2-1. FOR AIR TO WATER SYSTEM

Model name	Service ref.	Service manual No.
EHST20C-VM6HB EHST20C-YM9HB EHST20C-TM9HB EHST20C-VM2B EHST20C-VM6B EHST20C-YM9B EHST20C-VM6EB EHST20C-YM9EB EHST20C-VM6SB	EHST20C-VM6HB.UK EHST20C-YM9HB.UK EHST20C-TM9HB.UK EHST20C-VM2B.UK EHST20C-VM6B.UK EHST20C-YM9B.UK EHST20C-VM6EB.UK EHST20C-YM9EB.UK EHST20C-VM6SB.UK	OCH531/OCB531
EHSC-VM2B EHSC-VM6B EHSC-YM9B EHSC-TM9B EHSC-VM6EB EHSC-YM9EB ERSC-VM2B	EHSC-VM2B.UK EHSC-VM6B.UK EHSC-YM9B.UK EHSC-TM9B.UK EHSC-VM6EB.UK EHSC-YM9EB.UK ERSC-VM2B.UK	OCH532/OCB532
EHST20C-VM2C EHST20C-VM6C EHST20C-YM9C EHST20C-TM9C EHST20C-VM2EC EHST20C-VM6EC EHST20C-YM9EC EHST20C-MHCW EHST20C-MEC ERST20C-VM2C ERST20C-MEC	EHST20C-VM2C(R2).UK EHST20C-VM6C(R2).UK EHST20C-YM9C(R2).UK EHST20C-TM9C(R2).UK EHST20C-VM2EC(R2).UK EHST20C-VM6EC(R2).UK EHST20C-YM9EC(R2).UK EHST20C-MHCW(R2).UK EHST20C-MEC(R2).UK ERST20C-VM2C(R2).UK ERST20C-MEC(R2).UK	OCH570/OCB570
EHSC-MEC EHSC-VM2C EHSC-VM2EC EHSC-VM6C EHSC-VM6EC EHSC-YM9C EHSC-YM9EC EHSC-TM9C ERSC-MEC ERSC-VM2C	EHSC-MEC(R2).UK EHSC-VM2C(R2).UK EHSC-VM2EC(R2).UK EHSC-VM6C(R2).UK EHSC-VM6EC(R2).UK EHSC-YM9C(R2).UK EHSC-YM9EC(R2).UK EHSC-TM9C(R2).UK ERSC-MEC(R2).UK ERSC-VM2C(R2).UK	OCH571/OCB571



2-2. FOR AIR-CONDITIONER SYSTEM

Model name	Service Ref.	Service manual No.
PLA-RP71/125BA2	PLA-RP71/125BA2.UK	OCH412/OCB412
PLA-RP100BA3	PLA-RP100BA3	OCH459/OCB459
PLA-ZRP35/50/60/71/125BA	PLA-ZRP35/50/60/71/125BAR1.UK	OCH535/OCB535
PLA-ZRP100BA	PLA-ZRP100BAR1(-ER)	OCH529/OCB529
PKA-RP100KAL	PKA-RP100KALR1.TH(-ER)	OCH452/OCB452
PKA-RP60/100FAL PKA-RP50FAL2	PKA-RP60/100FAL#1 PKA-RP50FAL2#1	OC331
PKA-RP50HAL	PKA-RP50HALR1(-ER)	OCH453/OCB453
PEAD-RP50/60/71/100/125/JA(L)	PEAD-RP50/60/71/100/125/JA(L)(R1).UK	HWE08130 BWE09220 BWE09240
PEAD-RP50/60/71/100/125/JA(L)Q	PEAD-RP50/60/71/100/125/JA(L)Q.UK	BWE10160

3-1. ALWAYS OBSERVE FOR SAFETY

Before obtaining access to terminal, all supply circuits must be disconnected.

Preparation before the repair service.

- Prepare the proper tools.
- Prepare the proper protectors.
- Provide adequate ventilation.
- After stopping the operation of the air conditioner, turn off the power-supply breaker.
- Discharge the condenser before the work involving the electric parts.

Precautions during the repair service.

- Do not perform the work involving the electric parts with wet hands.
- Do not pour water into the electric parts.
- Do not touch the refrigerant.
- Do not touch the hot or cold areas in the refrigerating cycle.
- When the repair or the inspection of the circuit needs to be done without turning off the power, exercise great caution not to touch the live parts.

3-2. CAUTIONS RELATED TO NEW REFRIGERANT

Cautions for units utilizing refrigerant R410A

Use new refrigerant pipes.

In case of using the existing pipes for R22, be careful with the following:

- Be sure to perform replacement operation before test run.
- Change flare nut to the one provided with this product. Use a newly flared pipe.
- Avoid using thin pipes.

Make sure that the inside and outside of refrigerant piping is clean and it has no contaminants such as sulfur, oxides, dirt, shaving particles, etc, which are hazard to refrigerant cycle. In addition, use pipes with specified thickness.

Contamination inside refrigerant piping can cause deterioration of refrigerant oil, etc.

Store the piping indoors, and both ends of the piping sealed until just before brazing. (Leave elbow joints, etc. in their packaging.)

If dirt, dust or moisture enters into refrigerant cycle, that can cause deterioration of refrigerant oil or malfunction of compressor.

The refrigerant oil applied to flare and flange connections must be ester oil, ether oil or alkylbenzene oil in a small amount.

If large amount of mineral oil enters, that can cause deterioration of refrigerant oil, etc.

Charge refrigerant from liquid phase of gas cylinder.

If the refrigerant is charged from gas phase, composition change may occur in refrigerant and the efficiency will be lowered.

Do not use refrigerant other than R410A.

If other refrigerant (R22, etc.) is used, chlorine in refrigerant can cause deterioration of refrigerant oil, etc.

Use a vacuum pump with a reverse flow check valve.

Vacuum pump oil may flow back into refrigerant cycle and that can cause deterioration of refrigerant oil, etc.

Use the following tools specifically designed for use with R410A refrigerant.

The following tools are necessary to use R410A refrigerant.

Tools for R410A	
Gauge manifold	Flare tool
Charge hose	Size adjustment gauge
Gas leak detector	Vacuum pump adaptor
Torque wrench	Electronic refrigerant charging scale

Handle tools with care.

If dirt, dust or moisture enters into refrigerant cycle, that can cause deterioration of refrigerant oil or malfunction of compressor.

Do not use a charging cylinder.

If a charging cylinder is used, the composition of refrigerant will change and the efficiency will be lowered.

Ventilate the room if refrigerant leaks during operation. If refrigerant comes into contact with a flame, poisonous gases will be released.

Use the specified refrigerant only.

Never use any refrigerant other than that specified.

Doing so may cause a burst, an explosion, or fire when the unit is being used, serviced, or disposed of.

Correct refrigerant is specified in the manuals and on the spec labels provided with our products.

We will not be held responsible for mechanical failure, system malfunction, unit breakdown or accidents caused by failure to follow the instructions.

[1] Cautions for service

- (1) Perform service after recovering the refrigerant left in unit completely.
- (2) Do not release refrigerant in the air.
- (3) After completing service, charge the cycle with specified amount of refrigerant.
- (4) When performing service, install a filter drier simultaneously.
Be sure to use a filter drier for new refrigerant.

[2] Additional refrigerant charge

When charging directly from cylinder

- Check that cylinder for R410A on the market is a syphon type.
- Charging should be performed with the cylinder of syphon stood vertically. (Refrigerant is charged from liquid phase.)

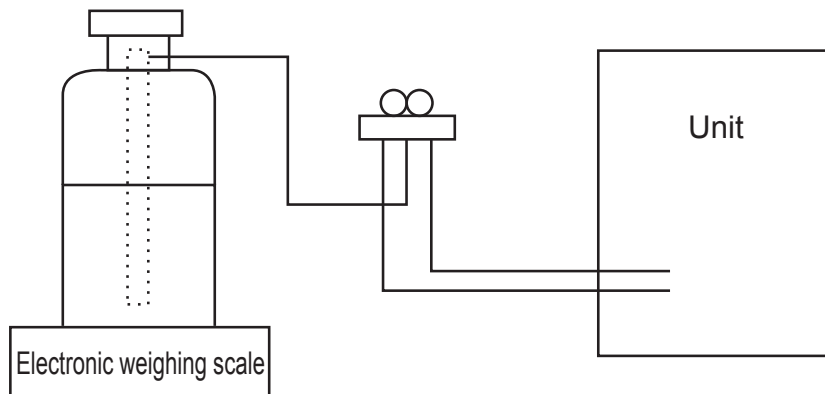

[3] Service tools

Use the below service tools as exclusive tools for R410A refrigerant.

No.	Tool name	Specifications
①	Gauge manifold	· Only for R410A
		· Use the existing fitting specifications. (UNF1/2)
		· Use high-tension side pressure of 5.3 MPa·G or over.
②	Charge hose	· Only for R410A
		· Use pressure performance of 5.09 MPa·G or over.
③	Electronic weighing scale	—
④	Gas leak detector	· Use the detector for R134a, R407C or R410A.
⑤	Adaptor for reverse flow check	· Attach on vacuum pump.
⑥	Refrigerant charge base	—
⑦	Refrigerant cylinder	· Only for R410A · Top of cylinder (Pink)
		· Cylinder with syphon
⑧	Refrigerant recovery equipment	—

[4] Refrigerant leakage detection function

This air conditioner can detect refrigerant leakage which may happen during a long period of use. In order to enable the leakage detection, settings are required to let the unit memorize the initial conditions (initial learning). Refer to "13-4. INITIAL SETTINGS FOR REFRIGERANT LEAKAGE DETECTION FUNCTION".

3-3. PRECAUTIONS WHEN REUSING EXISTING R22 REFRIGERANT PIPES

(1) Flowchart

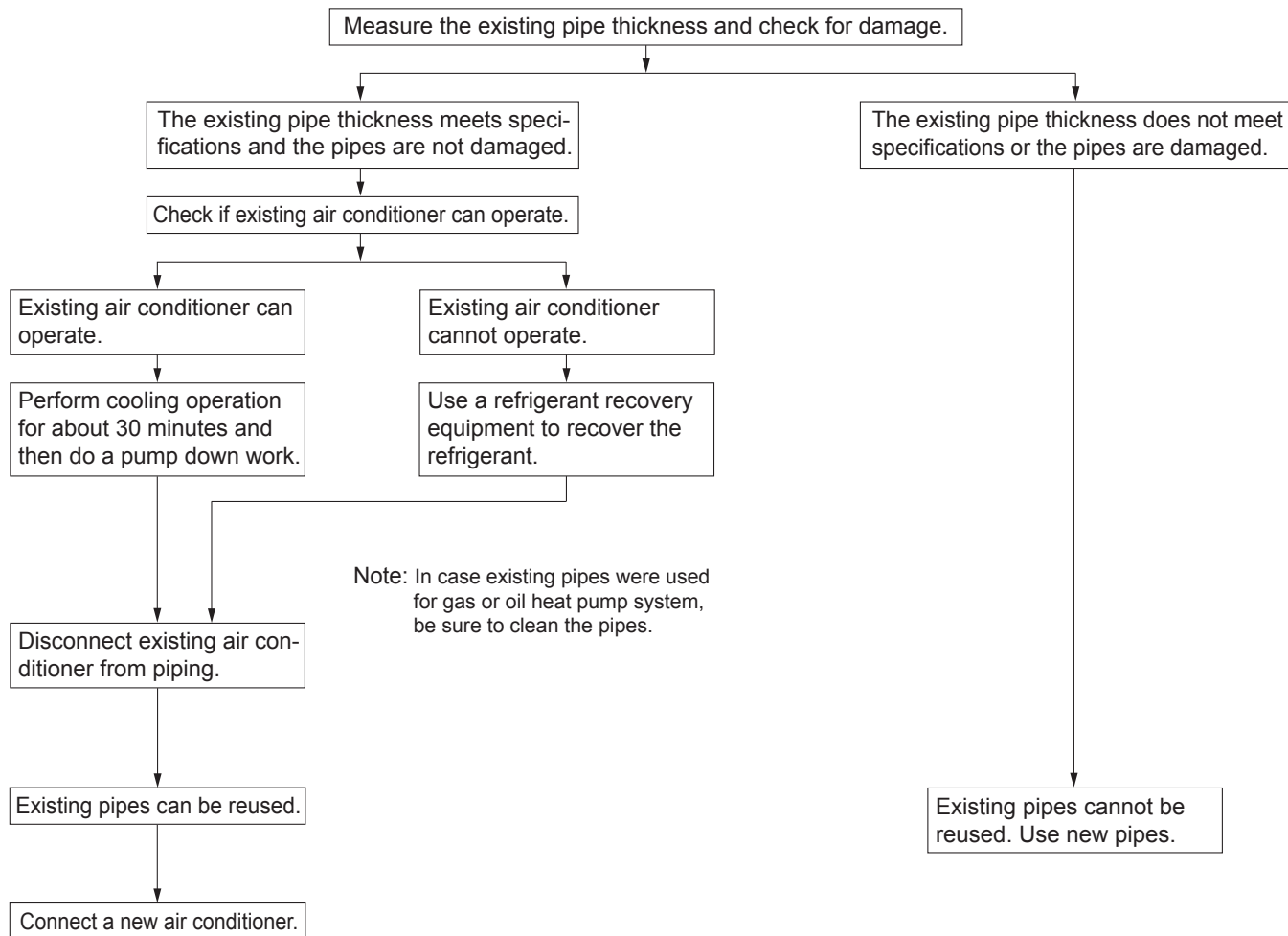

•The air conditioner automatically performs cooling operation through replace filter for about 2 hours.

Connecting a new air conditioner	SHW·HA
① Flaring work should be done so that flare meets the dimension for R410A. Use flare nut provided with indoor and outdoor unit.	✓
② When using gas piping of $\phi 19.05\text{mm}$ for SHW112, 140. Make sure that DIP SW8-1 on outdoor unit controller board is set to ON. This is to keep the pressure on pipes within permissible range. • Use different diameter joint or adjust the piping size by brazing.	✓
③ When using pipes larger than specified size for SHW80. Make sure that DIP SW8-1 on outdoor unit controller board is set to ON. This is to prevent oil flow ratio from lowering due to the decrease in flowing refrigerant. • Use different diameter joint or adjust the piping size by brazing.	✓
④ When existing pipes are specified size. The pipes can be reused. • Use different diameter joint or adjust the piping size by brazing.	✓

(2) Cautions for refrigerant piping work

New refrigerant R410A is adopted for replacement inverter series. Although the refrigerant piping work for R410A is same as for R22, exclusive tools are necessary so as not to mix with different kind of refrigerant. Furthermore as the working pressure of R410A is 1.6 times higher than that of R22, their sizes of flared sections and flare nuts are different.

① Thickness of pipes

Because the working pressure of R410A is higher compared to R22, be sure to use refrigerant piping with thickness shown below. (Never use pipes of 0.7 mm or below.)

Diagram below: Piping diameter and thickness

Nominal dimensions(inch)	Outside diameter (mm)	Thickness (mm)	
		R410A	R22
1/4	6.35	0.8	0.8
3/8	9.52	0.8	0.8
1/2	12.70	0.8	0.8
5/8	15.88	1.0	1.0
3/4	19.05	—	1.0

② Dimensions of flare cutting and flare nut

The component molecules in HFC refrigerant are smaller compared to conventional refrigerants. In addition to that, R410A is a refrigerant, which has higher risk of leakage because its working pressure is higher than that of other refrigerants. Therefore, to enhance airtightness and strength, flare cutting dimension of copper pipe for R410A has been specified separately from the dimensions for other refrigerants as shown below. The dimension B of flare nut for R410A also has partly been changed to increase strength as shown below. Set copper pipe correctly referring to copper pipe flaring dimensions for R410A below. For 1/2 and 5/8 inch pipes, the dimension B changes.

Use torque wrench corresponding to each dimension.

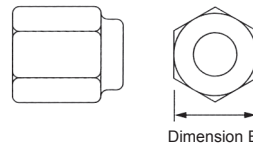
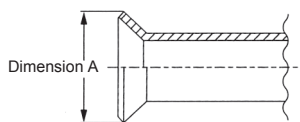

Flare cutting dimensions

Nominal dimensions(in)	Outside diameter (mm)	Dimension A ($^{+0}_{-0.4}$) (mm)	
		R410A	R22
1/4	6.35	9.1	9.0
3/8	9.52	13.2	13.0
1/2	12.70	16.6	16.2
5/8	15.88	19.7	19.4
3/4	19.05	—	23.3

Flare nut dimensions

Nominal dimensions(in)	Outside diameter (mm)	Dimension B (mm)	
		R410A	R22
1/4	6.35	17.0	17.0
3/8	9.52	22.0	22.0
1/2	12.70	26.0	24.0
5/8	15.88	29.0 *	27.0
3/4	19.05	-	36.0

* 36.0mm for indoor unit of RP100, 125 and 140

③ Tools for R410A (The following table shows whether conventional tools can be used or not.)

Tools and materials	Use	R410A tools	Can R22 tools be used?	Can R407C tools be used?
Gauge manifold	Air purge, refrigerant charge and operation check	Tool exclusive for R410A	×	×
Charge hose		Tool exclusive for R410A	×	×
Gas leak detector	Gas leak check	Tool for HFC refrigerant	×	○
Refrigerant recovery equipment	Refrigerant recovery	Tool exclusive for R410A	×	×
Refrigerant cylinder	Refrigerant charge	Tool exclusive for R410A	×	×
Applied oil	Apply to flared section	Ester oil, ether oil and alkylbenzene oil (minimum amount)	×	Ester oil, ether oil: ○ Alkylbenzene oil: minimum amount
Safety charger	Prevent compressor malfunction when charging refrigerant by spraying liquid refrigerant	Tool exclusive for R410A	×	×
Charge valve	Prevent gas from blowing out when detaching charge hose	Tool exclusive for R410A	×	×
Vacuum pump	Vacuum drying and air purge	Tools for other refrigerants can be used if equipped with adapter for reverse flow check	△ (Usable if equipped with adapter for reverse flow)	△ (Usable if equipped with adapter for reverse flow)
Flare tool	Flaring work of piping	Tools for other refrigerants can be used by adjusting flaring dimension	△ (Usable by adjusting flaring dimension)	△ (Usable by adjusting flaring dimension)
Bender	Bend the pipes	Tools for other refrigerants can be used	○	○
Pipe cutter	Cut the pipes	Tools for other refrigerants can be used	○	○
Welder and nitrogen gas cylinder	Weld the pipes	Tools for other refrigerants can be used	○	○
Refrigerant charging scale	Charge refrigerant	Tools for other refrigerants can be used	○	○
Vacuum gauge or thermistor vacuum gauge and vacuum valve	Check the degree of vacuum. (Vacuum valve prevents back flow of oil and refrigerant to thermistor vacuum gauge)	Tools for other refrigerants can be used	○	○
Charging cylinder	Refrigerant charge	Tool exclusive for R410A	×	—

× : Prepare a new tool. (Use the new tool as the tool exclusive for R410A.)

△ : Tools for other refrigerants can be used under certain conditions.

○ : Tools for other refrigerants can be used.

4

SPECIFICATIONS

Service Ref.				PUHZ-SHW80VHA		PUHZ-SHW112VHA	
OUTDOOR UNIT	Power supply (phase, cycle, voltage)			Single 50 Hz, 230 V			
	Max. current		A	29.5		35	
	External finish			Munsell 3Y 7.8/1.1			
	Refrigerant control			Linear Expansion Valve			
	Compressor			Hermetic			
	Model			ANB33FJMMT			
	Motor output		kW	2.5			
	Starter type			Inverter			
	Protection devices			HP switch, LP switch Discharge thermo, Comp. surface thermo			
	Crankcase heater		W	—			
	Heat exchanger			Plate fin coil			
	Fan		Fan(drive) × No.	Propeller fan × 2			
	Fan motor output		kW	0.074+0.074			
	Airflow		m ³ /min (CFM)	100 (3,530)			
	Defrost method			Reverse cycle			
	Noise level		Cooling	dB	50	51	51
			Heating	dB	51		52
	Dimensions		W	mm (in)	950 (37-3/8)		
			D	mm (in)	330+30 (13+1-3/16)		
			H	mm (in)	1,350 (53-1/8)		
Weight			kg (lb)	120 (265)			
Refrigerant			R410A				
Charge		kg (lb)	5.5 (12.1)				
Oil (Model)		L	1.40 (FV50S)				
REFRIGERANT PIPING	Pipe size O.D.		Liquid	mm (in)	9.52 (3/8)		
			Gas	mm (in)	15.88 (5/8)		
	Connection method		Indoor side		Flared		
			Outdoor side		Flared		
	Between the indoor & outdoor unit		Height difference		Maximum 30 m		
		Piping length		2 to 75 m			

Service Ref.				PUHZ-SHW112YHA PUHZ-SHW140YHA		PUHZ-SHW112YHAR1 PUHZ-SHW140YHAR1	
OUTDOOR UNIT	Power supply (phase, cycle, voltage)			3phase, 50 Hz, 400 V			
	Max. current		A	13			
	External finish			Munsell 3Y 7.8/1.1			
	Refrigerant control			Linear Expansion Valve			
	Compressor			Hermetic			
	Model			ANB33FJLMT			
	Motor output		kW	2.5			
	Starter type			Inverter			
	Protection devices			HP switch, LP switch Discharge thermo, Comp. surface thermo			
	Crankcase heater		W	—			
	Heat exchanger			Plate fin coil			
	Fan		Fan(drive) × No.	Propeller fan × 2			
	Fan motor output		kW	0.074+0.074			
	Airflow		m ³ /min (CFM)	100 (3,530)			
	Defrost method			Reverse cycle			
	Noise level		Cooling	dB	51		
			Heating	dB	52		
	Dimensions		W	mm (in)	950 (37-3/8)		
			D	mm (in)	330+30 (13+1-3/16)		
			H	mm (in)	1,350 (53-1/8)		
Weight			kg (lb)	134 (295)			
Refrigerant			R410A				
Charge		kg (lbs)	5.5 (12.1)				
Oil (Model)		L	1.40 (FV50S)				
REFRIGERANT PIPING	Pipe size O.D.		Liquid	mm (in)	9.52 (3/8)		
			Gas	mm (in)	15.88 (5/8)		
	Connection method		Indoor side		Flared		
			Outdoor side		Flared		
	Between the indoor & outdoor unit		Height difference		Maximum 30 m		
		Piping length		2 to 75 m			



Service Ref.			PUHZ-SHW80VHAR2(-BS).UK PUHZ-SHW80VHAR3(-BS).UK PUHZ-SHW80VHAR4(-BS).UK	PUHZ-SHW112VHAR2(-BS).UK PUHZ-SHW112VHAR3(-BS).UK PUHZ-SHW112VHAR4(-BS).UK	
OUTDOOR UNIT	Power supply (phase, cycle, voltage)		Single 50 Hz, 230 V		
	Max. current	A	29.5	35	
	External finish		Munsell 3Y 7.8/1.1		
	Refrigerant control		Linear Expansion Valve		
	Compressor		Hermetic		
	Model		ANB33FJRMT		
	Motor output	kW	2.5		
	Starter type		Inverter		
	Protection devices		HP switch, LP switch Discharge thermo, Comp. surface thermo		
	Crankcase heater		W		
	Heat exchanger		Plate fin coil		
	Fan	Fan(drive) × No.		Propeller fan × 2	
		Fan motor output		0.074+0.074	
		Airflow		m³/min (CFM) 100 (3,530)	
	Defrost method		Reverse cycle		
	Noise level	Cooling	dB	50	51
		Heating	dB	51	52
	Dimensions	W	mm (in)	950 (37-3/8)	
D		mm (in)	330+30 (13+1-3/16)		
H		mm (in)	1,350 (53-1/8)		
Weight		kg (lb)	120 (265)		
Refrigerant			R410A		
	Charge		kg (lb) 5.5 (12.1)		
	Oil (Model)		L 1.40 (FVC68D)		
REFRIGERANT PIPING	Pipe size O.D.		Liquid	mm (in) 9.52 (3/8)	
			Gas	mm (in) 15.88 (5/8)	
	Connection method		Indoor side	Flared	
			Outdoor side	Flared	
Between the indoor & outdoor unit		Height difference	Maximum 30 m		
		Piping length	2 to 75 m		

Service Ref.			PUHZ-SHW112YHAR2(-BS).UK PUHZ-SHW112YHAR3(-BS).UK PUHZ-SHW112YHAR4(-BS).UK PUHZ-SHW140YHAR2(-BS).UK PUHZ-SHW140YHAR3(-BS).UK PUHZ-SHW140YHAR4(-BS).UK PUHZ-SHW140YHAR5(-BS).UK		
OUTDOOR UNIT	Power supply (phase, cycle, voltage)		3phase, 50 Hz, 400 V		
	Max. current	A	13		
	External finish		Munsell 3Y 7.8/1.1		
	Refrigerant control		Linear Expansion Valve		
	Compressor		Hermetic		
	Model		ANB33FJQMT		
	Motor output	kW	2.5		
	Starter type		Inverter		
	Protection devices		HP switch, LP switch Discharge thermo, Comp. surface thermo		
	Crankcase heater		W		
	Heat exchanger		Plate fin coil		
	Fan	Fan(drive) × No.		Propeller fan × 2	
		Fan motor output		0.074+0.074	
		Airflow		m³/min (CFM) 100(3,353)	
	Defrost method		Reverse cycle		
	Noise level	Cooling	dB	51	
		Heating	dB	52	
	Dimensions	W	mm (in)	950(37-13/32)	
D		mm (in)	330+30(13+1-3/16)		
H		mm (in)	1,350(53-1/8)		
Weight		kg (lb)	134(296)		
Refrigerant			R410A		
	Charge		kg (lb) 5.5(12.1)		
	Oil (Model)		L 1.40(FVC68D)		
REFRIGERANT PIPING	Pipe size O.D.		Liquid	mm (in) 9.52(3/8)	
			Gas	mm (in) 15.88(5/8)	
	Connection method		Indoor side	Flared	
			Outdoor side	Flared	
Between the indoor & outdoor unit		Height difference	Maximum 30 m		
		Piping length	2 to 75 m		

5-1. REFILLING REFRIGERANT CHARGE (R410A: kg)

Service Ref.	Piping length (one way)							Factory charged
	10 m	20 m	30 m	40 m	50 m	60 m	75 m	
PUHZ-SHW80VHA PUHZ-SHW80VHAR2(-BS).UK PUHZ-SHW80VHAR3(-BS).UK PUHZ-SHW80VHAR4(-BS).UK	5.5	5.5	5.5	6.1	6.7	7.3	7.9	5.5
PUHZ-SHW112VHA PUHZ-SHW112YHA PUHZ-SHW112YHAR1 PUHZ-SHW112VHAR2(-BS).UK PUHZ-SHW112VHAR3(-BS).UK PUHZ-SHW112VHAR4(-BS).UK PUHZ-SHW112YHAR2(-BS).UK PUHZ-SHW112YHAR3(-BS).UK PUHZ-SHW112YHAR4(-BS).UK	5.5	5.5	5.5	6.1	6.7	7.3	7.9	5.5
PUHZ-SHW140YHA PUHZ-SHW140YHAR1 PUHZ-SHW140YHAR2(-BS).UK PUHZ-SHW140YHAR3(-BS).UK PUHZ-SHW140YHAR4(-BS).UK PUHZ-SHW140YHAR5(-BS).UK	5.5	5.5	5.5	6.1	6.7	7.3	7.9	5.5

Additional charge is required for pipes longer than 30 m.

5-2. COMPRESSOR TECHNICAL DATA

(at 20°C)

Service Ref.	PUHZ-SHW80VHA PUHZ-SHW112VHA	PUHZ-SHW112YHA PUHZ-SHW140YHA PUHZ-SHW112YHAR1 PUHZ-SHW140YHAR1	PUHZ-SHW80VHAR2(-BS).UK PUHZ-SHW80VHAR3(-BS).UK PUHZ-SHW80VHAR4(-BS).UK PUHZ-SHW112VHAR2(-BS).UK PUHZ-SHW112VHAR3(-BS).UK PUHZ-SHW112VHAR4(-BS).UK	PUHZ-SHW112YHAR2(-BS).UK PUHZ-SHW112YHAR3(-BS).UK PUHZ-SHW112YHAR4(-BS).UK PUHZ-SHW140YHAR2(-BS).UK PUHZ-SHW140YHAR3(-BS).UK PUHZ-SHW140YHAR4(-BS).UK PUHZ-SHW140YHAR5(-BS).UK	
Compressor model	ANB33FJMMT	ANB33FJLMT	ANB33FJRMT	ANB33FJQMT	
Winding Resistance (Ω)	U-V	0.188	0.302	0.188	0.305
	U-W	0.188	0.302	0.188	0.305
	W-V	0.188	0.302	0.188	0.305

5-3. NOISE CRITERION CURVES

- | | |
|--------------------------|--------------------------|
| PUHZ-SHW80VHA | PUHZ-SHW112VHA |
| PUHZ-SHW80VHAR2(-BS).UK | PUHZ-SHW112VHA2(-BS).UK |
| PUHZ-SHW80VHAR3(-BS).UK | PUHZ-SHW112VHA3(-BS).UK |
| PUHZ-SHW80VHAR4(-BS).UK | PUHZ-SHW112VHA4(-BS).UK |
| PUHZ-SHW112YHA | PUHZ-SHW140YHA |
| PUHZ-SHW112YHAR1 | PUHZ-SHW140YHAR1 |
| PUHZ-SHW112YHAR2(-BS).UK | PUHZ-SHW140YHAR2(-BS).UK |
| PUHZ-SHW112YHAR3(-BS).UK | PUHZ-SHW140YHAR3(-BS).UK |
| PUHZ-SHW112YHAR4(-BS).UK | PUHZ-SHW140YHAR4(-BS).UK |
| | PUHZ-SHW140YHAR5(-BS).UK |

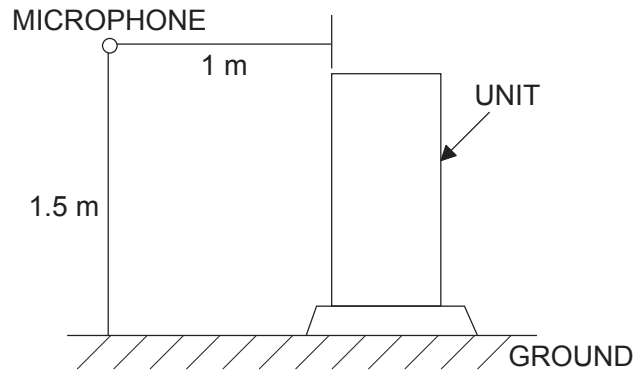
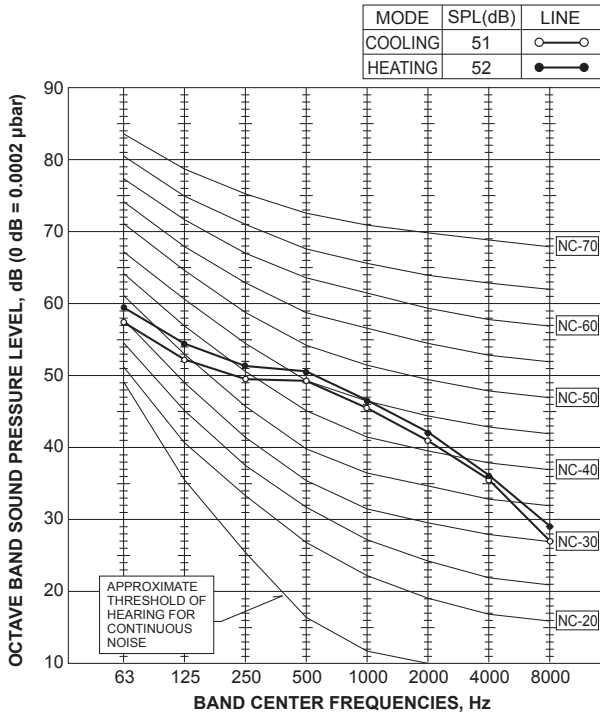

PUHZ-SHW80VHAR2.UK
 PUHZ-SHW80VHAR2-BS.UK
 PUHZ-SHW112VHAR2.UK
 PUHZ-SHW112VHAR2-BS.UK
 PUHZ-SHW112YHAR2.UK
 PUHZ-SHW112YHAR2-BS.UK
 PUHZ-SHW140YHAR2.UK
 PUHZ-SHW140YHAR2-BS.UK
 PUHZ-SHW140YHAR5.UK
 PUHZ-SHW140YHAR5-BS.UK

PUHZ-SHW80VHAR3.UK
 PUHZ-SHW80VHAR3-BS.UK
 PUHZ-SHW112VHAR3.UK
 PUHZ-SHW112VHAR3-BS.UK
 PUHZ-SHW112YHAR3.UK
 PUHZ-SHW112YHAR3-BS.UK
 PUHZ-SHW140YHAR3.UK
 PUHZ-SHW140YHAR3-BS.UK

PUHZ-SHW80VHAR4.UK
 PUHZ-SHW80VHAR4-BS.UK
 PUHZ-SHW112VHAR4.UK
 PUHZ-SHW112VHAR4-BS.UK
 PUHZ-SHW112YHAR4.UK
 PUHZ-SHW112YHAR4-BS.UK
 PUHZ-SHW140YHAR4.UK
 PUHZ-SHW140YHAR4-BS.UK

Unit: mm

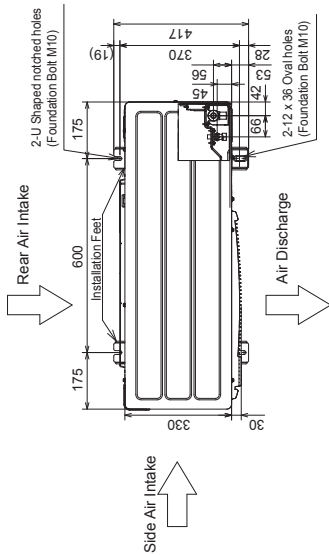

1 FREE SPACE (Around the unit)
 The diagram below shows a basic example. Explanation of particular details is given in the installation manuals etc.

2 SERVICE SPACE
 Dimensions of space needed for service access are shown in the below diagram.

3 FOUNDATION BOLTS
 Please secure the unit firmly with 4 foundation (M10) bolts. (Bolts and washers must be purchased locally)

4 PIPING-WIRING DIRECTIONS
 Piping and wiring connections can be made from 4 directions: front, right, rear and below.

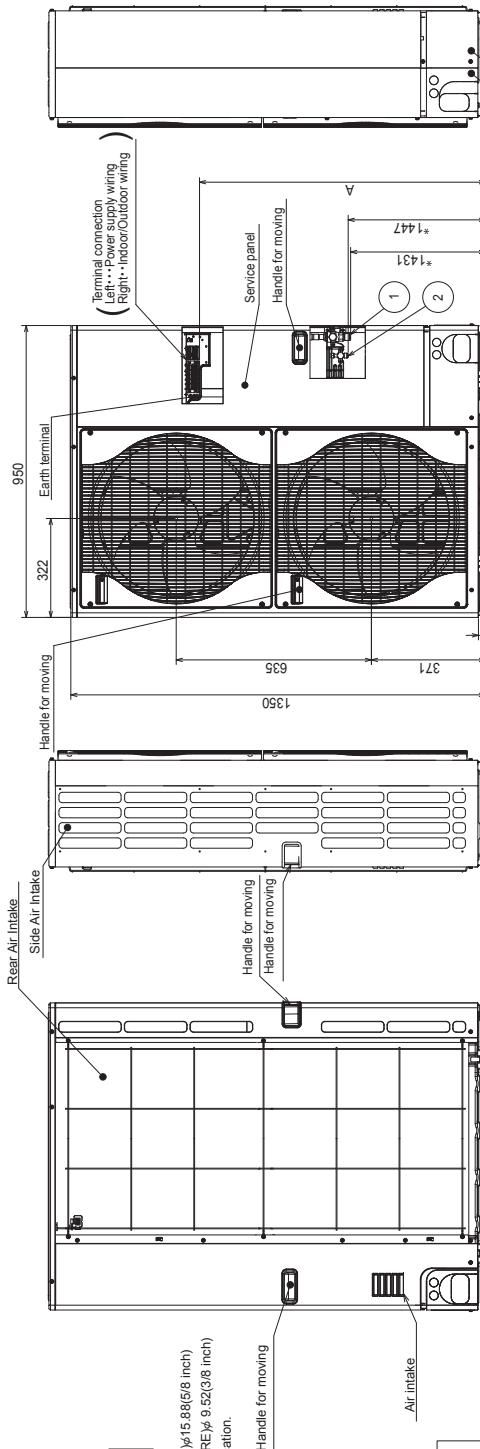

Example of Notes

- ① --- Refrigerant GAS pipe connection (FLARE)φ15.88(5/8 inch)
- ② --- Refrigerant LIQUID pipe connection (FLARE)φ 9.52(3/8 inch)
- *1 --- Indication of STOP VALVE connection location.

Piping Knockout Hole Details

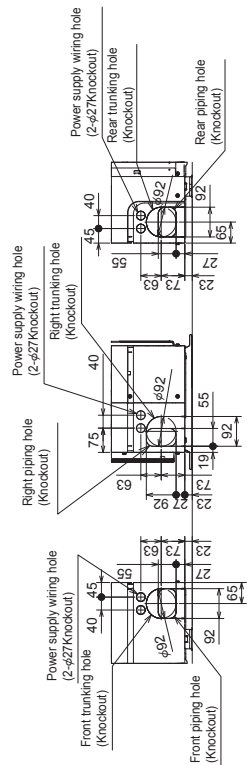

A	1,079
VHA	930
YHA	930

PUHZ-SHW80VHA PUHZ-SHW112VHA

SYMBOL	NAME	SYMBOL	NAME	SYMBOL	NAME
TB1	Terminal Block<Power Supply, Indoor/Outdoor>	DCL	Reactor	SW4	Switch<Test Operation>
MC	Motor for Compressor	CB	Main Smoothing Capacitor	SW5	Switch<Function Switch, Model Select>
MF1, MF2	Fan Motor	CY1, CY2	Capacitor	SW6	Switch<Model Select>
21S4	Solenoid Valve (Four-Way Valve)	P. B.	Power Circuit Board	SW7	Switch<Function Switch>
63H	High Pressure Switch	U, V, W	Connection Terminal<U/V/W-Phase>	SW8	Switch<Function Switch>
63L	Low Pressure Switch	LI	Connection Terminal<L-Phase>	SW9	Switch<Function Switch>
63HS	High Pressure Sensor	NI	Connection Terminal<N-Phase>	SWP	Switch<Pump Down>
TH3	Thermistor<Liquid>	P2	Connection Terminal	CN31	Connector<Emergency Operation>
TH4	Thermistor<Discharge>	N2	Connection Terminal	CNDM	Connector<Connection for Option>
TH6	Thermistor<2-Phase Pipe>	DCL1, DCL2	Connection Terminal<Reactor>	CN51	Connector<Connection for Option>
TH7	Thermistor<Ambient>	IGBT	Power Module	SV1/CH	Connector<Connection for Option>
TH8	Thermistor (internal) <Heat Sink>	E1, E2, E3, E4	Connection Terminal<Ground>	SS	Connector<Connection for Option>
TH32	Thermistor<Suction>	52C	52C Relay	CNM	Connector<Connection for Option>
TH33	Thermistor<Ref. check>	C. B.	Controller Circuit Board	LED1, LED2	LED<Operation Inspection Indicators>
TH34	Thermistor<Comp. Surface>	SW1	Switch<Manual Defrost, Defect History, Record Reset, Refrigerant Address>	F1, F2, F3, F4	Fuse<T6.3AL250V>
LEV-A, LEV-B, LEV-C	Linear Expansion Valve			X51, X52, X54	Relay

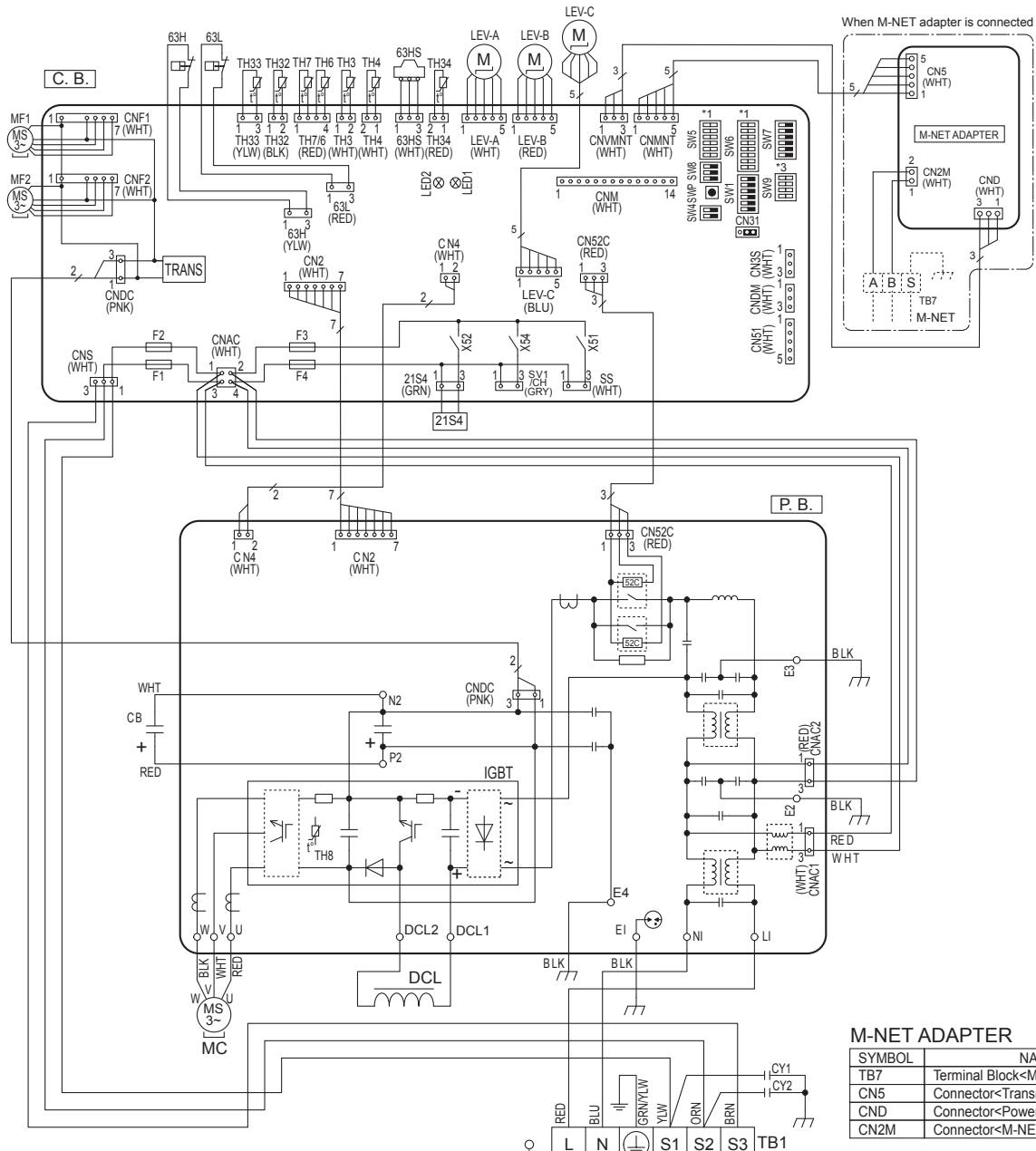

M-NET ADAPTER

SYMBOL	NAME
TB7	Terminal Block<M-NET connection>
CN5	Connector<Transmission>
CND	Connector<Power Supply>
CN2M	Connector<M-NET communication>

*3 Ambient temp. of ZUBADAN Flash Injection becomes effective. The black square (■) indicates a switch position.

Ambient temp.	SW9-3,4 *4	Ambient temp.	SW9-3,4 *4
3°C or less (Initial setting)	ON OFF <input type="checkbox"/> <input type="checkbox"/> <input type="checkbox"/> <input type="checkbox"/>	-3°C or less	ON OFF <input type="checkbox"/> <input type="checkbox"/> <input type="checkbox"/> <input type="checkbox"/>
0°C or less	ON OFF <input type="checkbox"/> <input type="checkbox"/> <input type="checkbox"/> <input type="checkbox"/>	-6°C or less	ON OFF <input type="checkbox"/> <input type="checkbox"/> <input type="checkbox"/> <input type="checkbox"/>

*4 SW9-1 to 2 : Function Switch

*1 MODEL SELECT The black square (■) indicates a switch position.

MODEL	SW6	SW5-6 *2
80V	ON OFF <input type="checkbox"/> <input type="checkbox"/> <input type="checkbox"/> <input type="checkbox"/> <input type="checkbox"/> <input type="checkbox"/>	ON OFF <input type="checkbox"/> <input type="checkbox"/> <input type="checkbox"/> <input type="checkbox"/> <input type="checkbox"/> <input type="checkbox"/>
112V	ON OFF <input type="checkbox"/> <input type="checkbox"/> <input type="checkbox"/> <input type="checkbox"/> <input type="checkbox"/> <input type="checkbox"/>	ON OFF <input type="checkbox"/> <input type="checkbox"/> <input type="checkbox"/> <input type="checkbox"/> <input type="checkbox"/> <input type="checkbox"/>

*2 SW5 -1 to 5 : Function Switch

PUHZ-SHW112YHA

PUHZ-SHW140YHA

SYMBOL	NAME	SYMBOL	NAME	SYMBOL	NAME
TB1	Terminal Block<Power Supply>	CK	Capacitor	C. B.	Controller Circuit Board
TB2	Terminal Block<Indoor/Outdoor>	RS	Rush Current Protect Resistor	SW1	Switch<Manual Defrost, Defect History, Record Reset, Refrigerant Address>
MC	Motor for Compressor	P. B.	Power Circuit Board	SW4	Switch<Test Operation>
MF1, MF2	Fan Motor	TB-U/V/W	Connection Terminal<U/V/W-Phase>	SW5	Switch<Function Switch, Model Select>
21S4	Solenoid Valve (Four-Way Valve)	TB-L1/L2/L3	Connection Terminal<L1/L2/L3-Power Supply>	SW6	Switch<Model Select>
63H	High Pressure Switch	TB-N	Connection Terminal	SW7	Switch<Function Switch>
63L	Low Pressure Switch	X52CA	52C Relay	SW8	Switch<Function Switch>
63HS	High Pressure Sensor	N. F.	Noise Filter Circuit Board	SW9	Switch<Function Switch>
TH3	Thermistor<Liquid>	L11, L12, L13, NI	Connection Terminal<L1/L2/L3/N-Power Supply>	SWP	Switch<Pump Down>
TH4	Thermistor<Discharge>	LO1, LO2, LO3, NO	Connection Terminal<L1/L2/L3/N-Power Supply>	CN31	Connector<Emergency Operation>
TH6	Thermistor<2-Phase Pipe>	GD1, GD3	Connection Terminal<Ground>	CNDM	Connector<Connection for Option>
TH7	Thermistor<Ambient>	CONV. B.	Converter Circuit Board	CN51	Connector<Connection for Option>
TH8	Thermistor<Heat Sink>	L1-A1/IN	Connection Terminal<L1-Power Supply>	SV1/CH	Connector<Connection for Option>
TH32	Thermistor<Suction>	L2-A2/OU	Connection Terminal<L2-Power Supply>	SS	Connector<Connection for Option>
TH33	Thermistor<Ref. check>	L3-A2/OU	Connection Terminal<L3-Power Supply>	CNM	Connector<Connection for Option>
TH34	Thermistor<Comp. Surface>	N-IN	Connection Terminal	LED1, LED2	LED<Operation Inspection Indicators>
LEV-A, LEV-B, LEV-C	Linear Expansion Valve	CK-OU	Connection Terminal	F1, F2, F3, F4	FUSE<T6.3AL250V>
AQ1, AQ2, AQ3, AQ4	Reactor			X51, X52, X54	Relay
CY1, CY2	Capacitor				

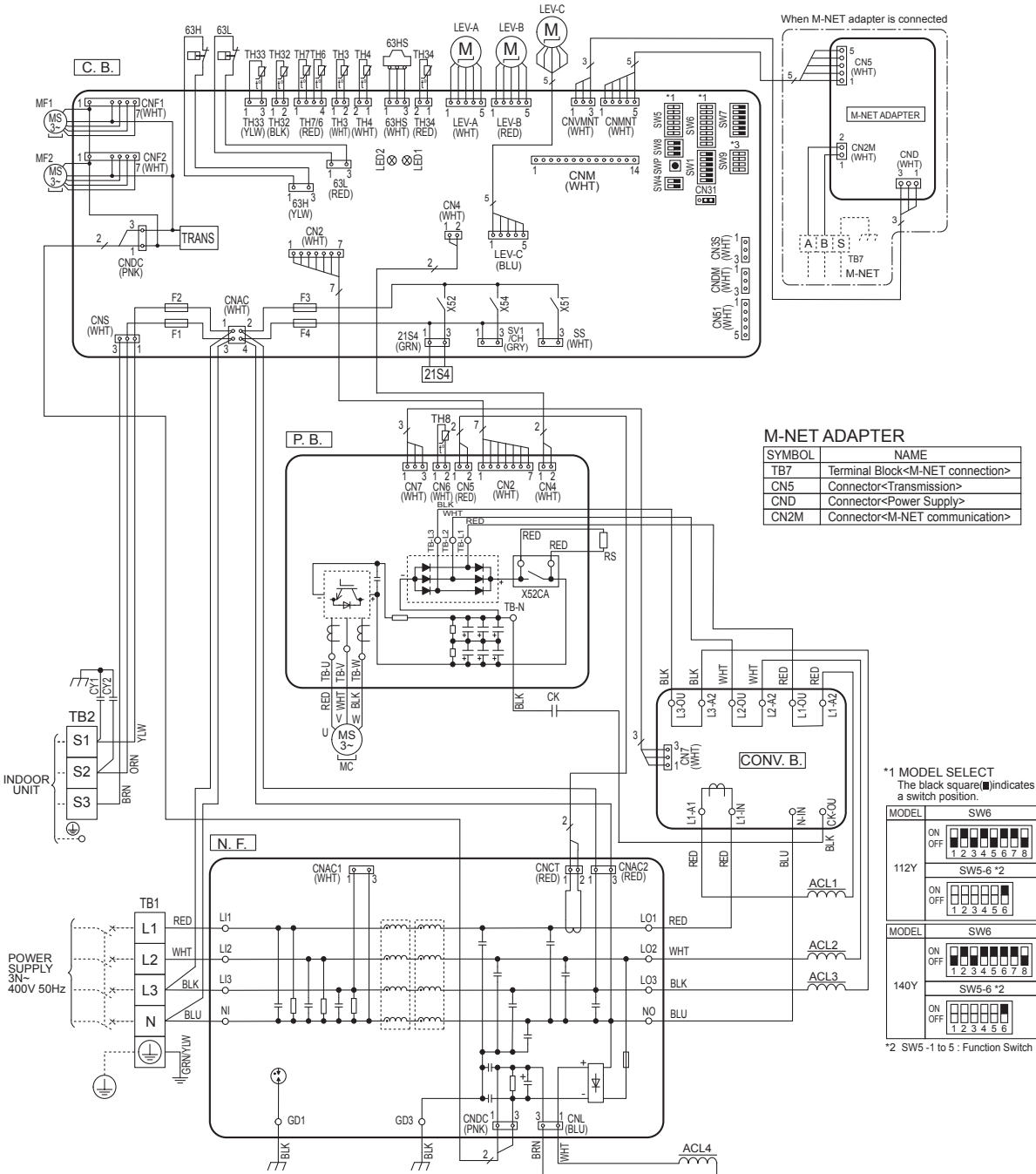

M-NET ADAPTER

SYMBOL	NAME
TB7	Terminal Block<M-NET connection>
CN5	Connector<Transmission>
CND	Connector<Power Supply>
CN2M	Connector<M-NET communication>

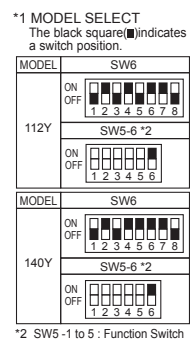

*3 Ambient temp. of ZUBADAN Flash Injection becomes effective. The black square indicates a switch position.

Ambient temp.	SW9-3,4 *4	Ambient temp.	SW9-3,4 *4	Ambient temp.	SW9-3,4 *4	Ambient temp.	SW9-3,4 *4
3°C or less (Initial setting)	ON OFF [1 2 3 4]	0°C or less	ON OFF [1 2 3 4]	-3°C or less	ON OFF [1 2 3 4]	-6°C or less	ON OFF [1 2 3 4]

*4 SW9-1 to 2 : Function Switch

PUHZ-SHW112YHAR1

PUHZ-SHW140YHAR1

SYMBOL	NAME	SYMBOL	NAME	SYMBOL	NAME
TB1	Terminal Block <Power Supply>	CK	Capacitor	C. B.	Controller Circuit Board
TB2	Terminal Block <Indoor/Outdoor>	RS	Rush Current Protect Resistor	SW1	Switch <Manual Defrost, Defect History, Record Reset, Refrigerant Address>
MC	Motor for Compressor	P. B.	Power Circuit Board <L1/L2/L3-Power Supply>	SW4	Switch <Test Operation>
MF1, MF2	Fan Motor	TB-U/W/V	Connection Terminal <U/W/V-Phase>	SW5	Switch <Function Switch, Model Select>
21S4	Solenoid Valve (Four-Way Valve)	TB-L1/L2/L3	Connection Terminal	SW6	Switch <Model Select>
63H	High Pressure Switch	TB-N	Connection Terminal	SW7	Switch <Function Switch>
63L	Low Pressure Switch	X52CA/B	52C Relay	SW8	Switch <Function Switch>
63HS	High Pressure Sensor	N. F.	Noise Filter Circuit Board	SW9	Switch <Function Switch>
TH3	Thermistor <Liquid>	L1, L2, L3, NI	Connection Terminal <L1/L2/L3/N-Power Supply>	SWP	Switch <Pump Down>
TH4	Thermistor <Discharge>	L01, L02, L03, NO	Connection Terminal <L1/L2/L3/N-Power Supply>	CN31	Connector <Emergency Operation>
TH6	Thermistor <2-Phase Pipe>	GD1, GD3	Connection Terminal <Ground>	CNDM	Connector <Connection for Option>
TH7	Thermistor <Ambient>	CONV. B.	Converter Circuit Board	CN51	Connector <Connection for Option>
TH8	Thermistor <Heat Sink>	L1-A1/IN	Connection Terminal <L1-Power Supply>	SV1/CH	Connector <Connection for Option>
TH32	Thermistor <Suction>	L1-A2/OU	Connection Terminal <L1-Power Supply>	SS	Connector <Connection for Option>
TH33	Thermistor <Ref. check>	L2-A2/OU	Connection Terminal <L2-Power Supply>	CNM	Connector <Connection for Option>
TH34	Thermistor <Comp. Surface>	L3-A2/OU	Connection Terminal <L3-Power Supply>	LED1, LED2	LED <Operation Inspection Indicators>
LEV-A, LEV-B, LEV-C	Linear Expansion Valve	N-IN	Connection Terminal	F1, F2, F3, F4	FUSE <T6.3AL250V>
AC1, AC2, AC3, AC4	Reactor	CK-OU	Connection Terminal	X51, X52, X54	Relay
CY1, CY2	Capacitor				

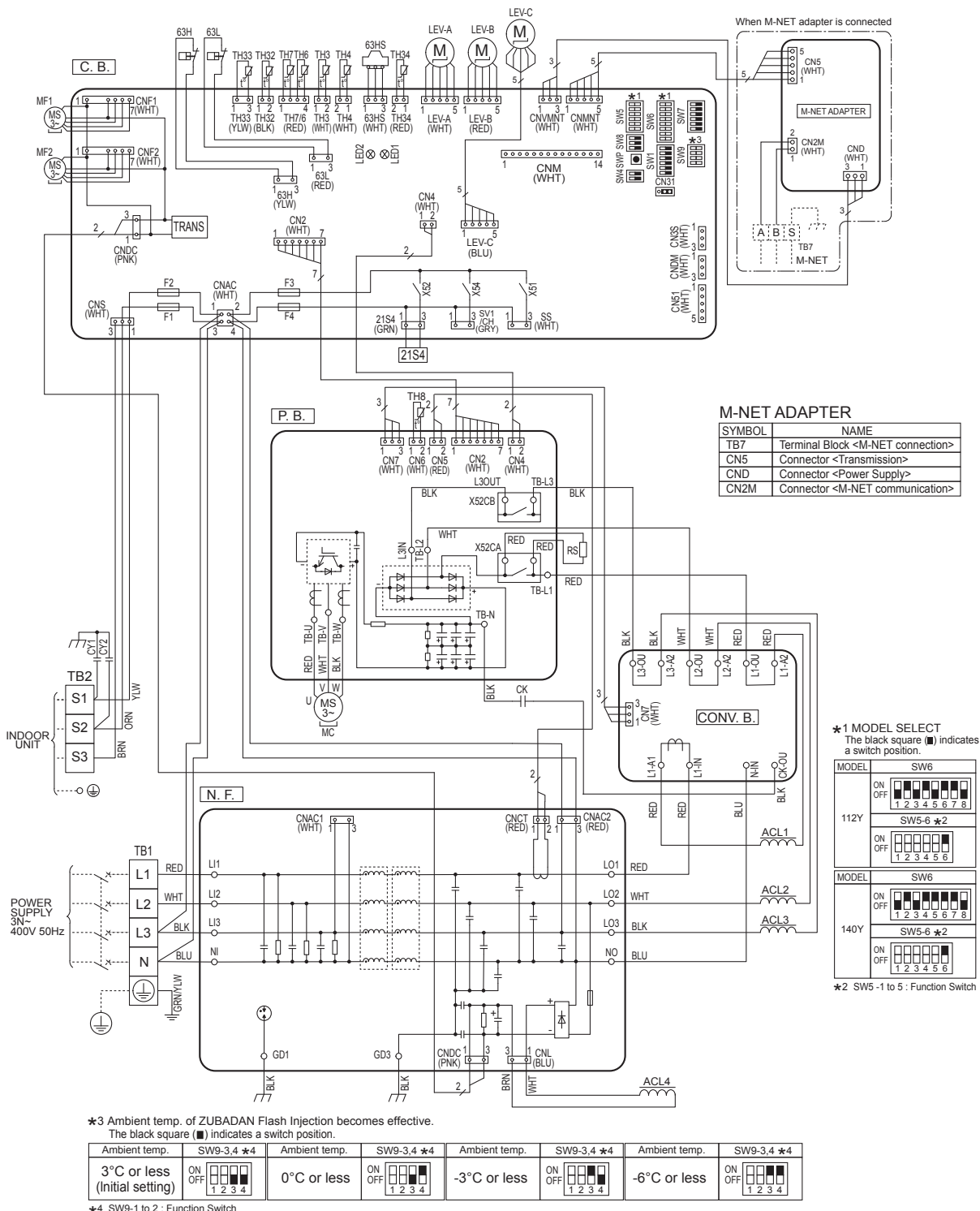

PUHZ-SHW80VHAR2.UK
 PUHZ-SHW80VHAR2-BS.UK
 PUHZ-SHW112VHAR2.UK
 PUHZ-SHW112VHAR2-BS.UK

PUHZ-SHW80VHAR3.UK
 PUHZ-SHW80VHAR3-BS.UK
 PUHZ-SHW112VHAR3.UK
 PUHZ-SHW112VHAR3-BS.UK

SYMBOL	NAME	SYMBOL	NAME	SYMBOL	NAME
TB1	Terminal Block <Power Supply, Indoor/Outdoor>	DCL	Reactor	SW4	Switch <Test Operation>
MC	Motor for Compressor	CB	Main Smoothing Capacitor	SW5	Switch <Function Switch, Model Select>
MF1, MF2	Fan Motor	CY1, CY2	Capacitor	SW6	Switch <Model Select>
21S4	Solenoid Valve (Four-Way Valve)	P. B.	Power Circuit Board	SW7	Switch <Function Switch>
63H	High Pressure Switch	U, V, W	Connection Terminal <U/V/W-Phase>	SW8	Switch <Function Switch>
63L	Low Pressure Switch	LI	Connection Terminal <L-Phase>	SW9	Switch <Function Switch>
63HS	High Pressure Sensor	NI	Connection Terminal <N-Phase>	SWP	Switch <Pump Down>
TH3	Thermistor <Liquid>	P2	Connection Terminal	CN31	Connector <Emergency Operation>
TH4	Thermistor <Discharge>	N2	Connection Terminal	CNDM	Connector <Connection for Option>
TH6	Thermistor <2-Phase Pipe>	DCL1, DCL2	Connection Terminal <Reactor>	CN51	Connector <Connection for Option>
TH7	Thermistor <Ambient>	IGBT	Power Module	SV1/CH	Connector <Connection for Option>
TH8	Thermistor (internal) <Heat Sink>	E1, E2, E3, E4	Connection Terminal <Ground>	SS	Connector <Connection for Option>
TH32	Thermistor <Suction>	52C	52C Relay	CNM	Connector <Connection for Option>
TH33	Thermistor <Ref. check>	C. B.	Controller Circuit Board	LED1, LED2	LED <Operation Inspection Indicators>
TH34	Thermistor <Comp. Surface>	SW1	Switch <Manual Defrost, Defect History, Record Reset, Refrigerant Address>	F1, F2, F3, F4	Fuse <T6.3AL250V>
LEV-A, LEV-B, LEV-C	Linear Expansion Valve			X51, X52, X54	Relay

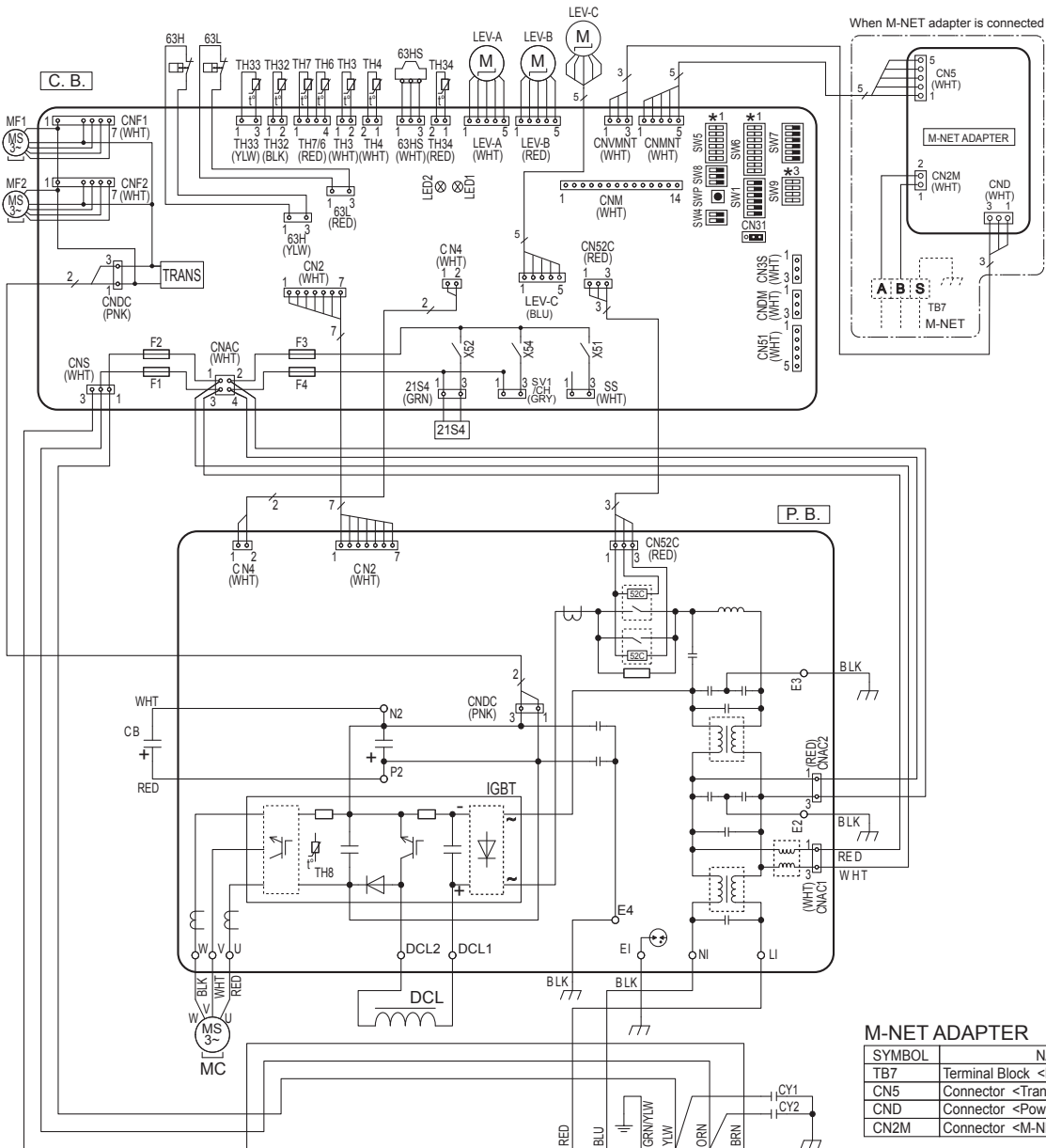

M-NET ADAPTER

SYMBOL	NAME
TB7	Terminal Block <M-NET connection>
CN5	Connector <Transmission>
CND	Connector <Power Supply>
CN2M	Connector <M-NET communication>

*3 Ambient temp. of ZUBADAN Flash Injection becomes effective.
 The black square (■) indicates a switch position.

Ambient temp.	SW9-3,4 *4	Ambient temp.	SW9-3,4 *4
3°C or less (Initial setting)	ON OFF <input type="checkbox"/> <input type="checkbox"/> <input type="checkbox"/> <input type="checkbox"/> 1 2 3 4	-3°C or less	ON OFF <input type="checkbox"/> <input type="checkbox"/> <input type="checkbox"/> <input type="checkbox"/> 1 2 3 4
0°C or less	ON OFF <input type="checkbox"/> <input type="checkbox"/> <input type="checkbox"/> <input type="checkbox"/> 1 2 3 4	-6°C or less	ON OFF <input type="checkbox"/> <input type="checkbox"/> <input type="checkbox"/> <input type="checkbox"/> 1 2 3 4

*4 SW9-1 to 2 : Function Switch

*1 MODEL SELECT
 The black square (■) indicates a switch position.

MODEL	SW6	SW5-6 *2
80V	ON OFF <input type="checkbox"/> <input type="checkbox"/> <input type="checkbox"/> <input type="checkbox"/> <input type="checkbox"/> <input type="checkbox"/> 1 2 3 4 5 6 8	ON OFF <input type="checkbox"/> <input type="checkbox"/> <input type="checkbox"/> <input type="checkbox"/> <input type="checkbox"/> 1 2 3 4 5 6
112V	ON OFF <input type="checkbox"/> <input type="checkbox"/> <input type="checkbox"/> <input type="checkbox"/> <input type="checkbox"/> <input type="checkbox"/> 1 2 3 4 5 6 7 8	ON OFF <input type="checkbox"/> <input type="checkbox"/> <input type="checkbox"/> <input type="checkbox"/> <input type="checkbox"/> 1 2 3 4 5 6

*2 SW5-1 to 5 : Function Switch

PUHZ-SHW80VHAR4.UK
PUHZ-SHW80VHAR4-BS.UK

PUHZ-SHW112VHAR4.UK
PUHZ-SHW112VHAR4-BS.UK

SYMBOL	NAME	SYMBOL	NAME	SYMBOL	NAME
TB1	Terminal Block <Power Supply, Indoor/Outdoor>	TH32	Thermistor <Suction>	SW7	Switch <Function Switch>
MC	Motor for Compressor	TH33	Thermistor <Ref. check>	SW8	Switch <Function Switch>
MF1, MF2	Fan Motor	TH34	Thermistor <Comp. Surface>	SW9	Switch <Function Switch>
21S4	Solenoid Valve (4-Way Valve)	LEV-A, LEV-B, LEV-C	Linear Expansion Valve	SWP	Switch <Pump Down>
63H	High Pressure Switch	DCL	Reactor	CN31	Connector <Emergency Operation>
63L	Low Pressure Switch	CY1, CY2	Capacitor	CNDM	Connector <Connection for Option>
63HS	High Pressure Sensor	P. B.	Power Circuit Board	SV1/CH	Connector <Connection for Option>
TH3	Thermistor <Liquid>	C. B.	Controller Circuit Board	SV3/SS	Connector <Connection for Option>
TH4	Thermistor <Discharge>	SW1	Switch <Manual Defrost, Defect History Record Reset, Refrigerant Address>	CNM	Connector <Connection for Option>
TH6	Thermistor <2-Phase Pipe>	SW4	Switch <Test Operation>	F1, F2, F3, F4	Fuse <T6.3AL250V>
TH7	Thermistor <Ambient>	SW5	Switch <Function Switch, Model Select>		
TH8	Thermistor internal <Heat Sink>	SW6	Switch <Model Select>		

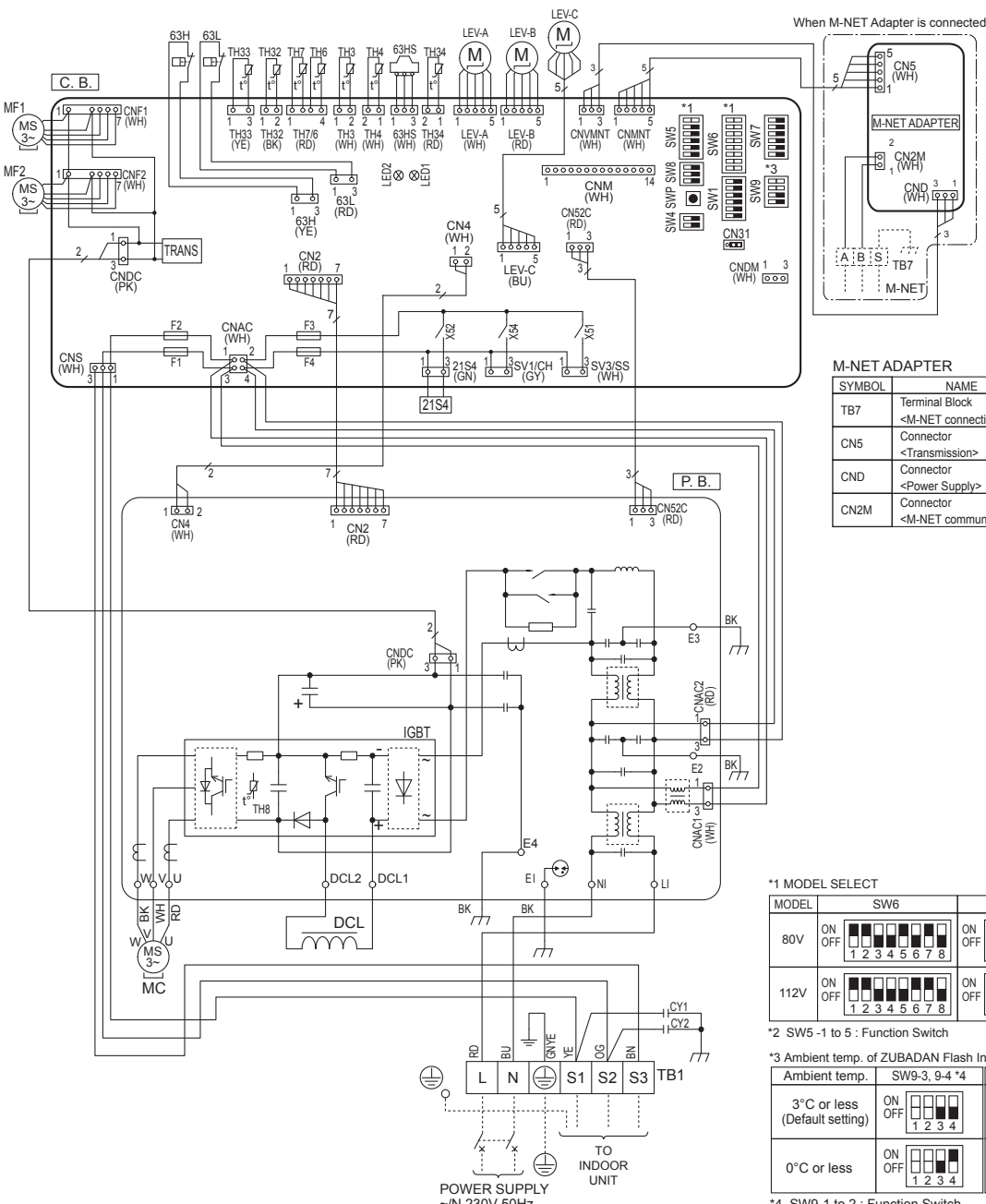

M-NET ADAPTER

SYMBOL	NAME
TB7	Terminal Block <M-NET connection>
CN5	Connector <Transmission>
CND	Connector <Power Supply>
CN2M	Connector <M-NET communication>

***1 MODEL SELECT**

MODEL	SW6	SW5-6 *2
80V	ON OFF <input type="checkbox"/> <input type="checkbox"/> <input type="checkbox"/> <input type="checkbox"/> <input type="checkbox"/> <input type="checkbox"/> <input type="checkbox"/> <input type="checkbox"/>	ON OFF <input type="checkbox"/> <input type="checkbox"/> <input type="checkbox"/> <input type="checkbox"/> <input type="checkbox"/> <input type="checkbox"/>
112V	ON OFF <input type="checkbox"/> <input type="checkbox"/> <input type="checkbox"/> <input type="checkbox"/> <input type="checkbox"/> <input type="checkbox"/> <input type="checkbox"/> <input type="checkbox"/>	ON OFF <input type="checkbox"/> <input type="checkbox"/> <input type="checkbox"/> <input type="checkbox"/> <input type="checkbox"/> <input type="checkbox"/>

*2 SW5 -1 to 5 : Function Switch

*3 Ambient temp. of ZUBADAN Flash Injection becomes effective.

Ambient temp.	SW9-3, 9-4 *4	Ambient temp.	SW9-3, 9-4 *4
3°C or less (Default setting)	ON OFF <input type="checkbox"/> <input type="checkbox"/> <input type="checkbox"/> <input type="checkbox"/>	-3°C or less	ON OFF <input type="checkbox"/> <input type="checkbox"/> <input type="checkbox"/> <input type="checkbox"/>
0°C or less	ON OFF <input type="checkbox"/> <input type="checkbox"/> <input type="checkbox"/> <input type="checkbox"/>	-6°C or less	ON OFF <input type="checkbox"/> <input type="checkbox"/> <input type="checkbox"/> <input type="checkbox"/>

*4 SW9-1 to 2 : Function Switch
 The black square (■) indicates a switch position.

PUHZ-SHW112YHAR2.UK
 PUHZ-SHW112YHAR2-BS.UK
 PUHZ-SHW140YHAR2.UK
 PUHZ-SHW140YHAR2-BS.UK

PUHZ-SHW112YHAR3.UK
 PUHZ-SHW112YHAR3-BS.UK
 PUHZ-SHW140YHAR3.UK
 PUHZ-SHW140YHAR3-BS.UK

SYMBOL	NAME	SYMBOL	NAME	SYMBOL	NAME
TB1	Terminal Block (Power Supply)	CK	Capacitor	C. B.	Controller Circuit Board
TB2	Terminal Block (Indoor/Outdoor)	RS	Rush Current Protect Resistor	SW1	Switch (Manual Defrost, Defect History, Record Reset, Refrigerant Address)
MC	Motor for Compressor	P. B.	Power Circuit Board (L1/L2/L3-Power Supply)	SW4	Switch (Test Operation)
MF1, MF2	Fan Motor	TB-U/V/W	Connection Terminal (U/V/W-Phase)	SW5	Switch (Function Switch, Model Select)
21S4	Solenoid Valve (Four-Way Valve)	TB-L1/L2/L3	Connection Terminal	SW6	Switch (Model Select)
63H	High Pressure Switch	TB-N	Connection Terminal	SW7	Switch (Function Switch)
63L	Low Pressure Switch	X52CA/B	52C Relay	SW8	Switch (Function Switch)
63HS	High Pressure Sensor	N. F.	Noise Filter Circuit Board	SW9	Switch (Function Switch)
TH3	Thermistor (Liquid)	L11, L12, L13, NI	Connection Terminal (L1/L2/L3/N-Power Supply)	SWP	Switch (Pump Down)
TH4	Thermistor (Discharge)	LO1, LO2, LO3, NO	Connection Terminal (L1/L2/L3/N-Power Supply)	CN31	Connector (Emergency Operation)
TH6	Thermistor (2-Phase Pipe)	GD1, GD3	Connection Terminal (Ground)	CNDM	Connector (Connection for Option)
TH7	Thermistor (Ambient)	CONV. B.	Converter Circuit Board	CN51	Connector (Connection for Option)
TH8	Thermistor (Heat Sink)	L1-A1/IN	Connection Terminal (L1-Power Supply)	SV1/CH	Connector (Connection for Option)
TH32	Thermistor (Suction)	L1-A2/OU	Connection Terminal (L1-Power Supply)	SS	Connector (Connection for Option)
TH33	Thermistor (Ref. check)	L2-A2/OU	Connection Terminal (L2-Power Supply)	CNM	Connector (Connection for Option)
TH34	Thermistor (Comp. Surface)	L3-A2/OU	Connection Terminal (L3-Power Supply)	LED1, LED2	LED (Operation Inspection Indicators)
LEV-A, LEV-B, LEV-C	Linear Expansion Valve	N-IN	Connection Terminal	F1, F2, F3, F4	FUSE (T6.3AL250V)
ACL1, ACL2, ACL3, ACL4	Reactor	CK-OU	Connection Terminal	X51, X52, X54	Relay
CY1, CY2	Capacitor				

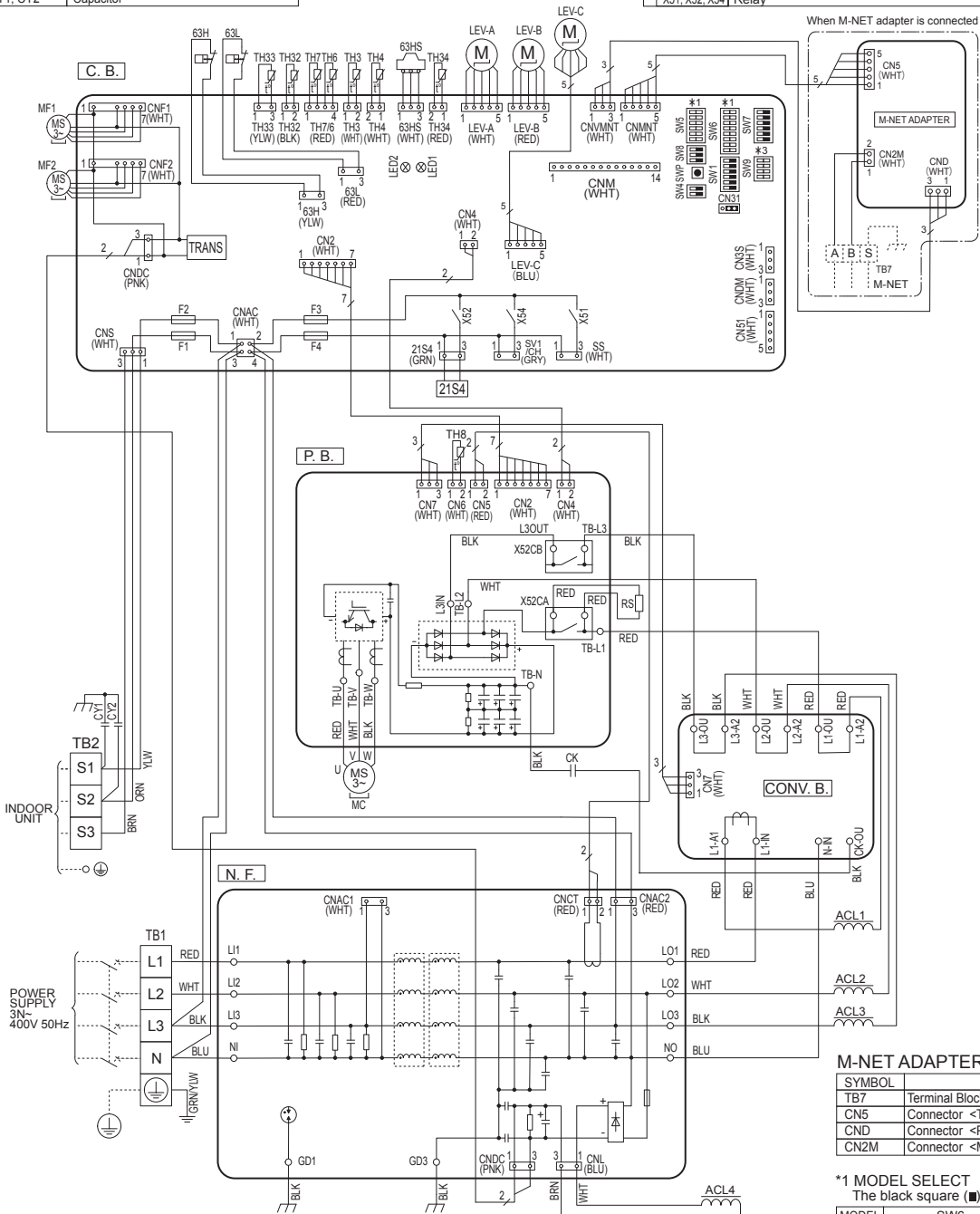

M-NET ADAPTER

SYMBOL	NAME
TB7	Terminal Block <M-NET connection>
CN5	Connector <Transmission>
CND	Connector <Power Supply>
CN2M	Connector <M-NET communication>

*1 MODEL SELECT
 The black square (■) indicates a switch position.

MODEL	SW6	SW5-6 *2
112Y	ON OFF [■] [■] [■] [■] [■] [■] [■] [■] 1 2 3 4 5 6 7 8	ON OFF [■] [■] [■] [■] [■] [■] 1 2 3 4 5 6
140Y	ON OFF [■] [■] [■] [■] [■] [■] [■] [■] 1 2 3 4 5 6 7 8	ON OFF [■] [■] [■] [■] [■] [■] 1 2 3 4 5 6

*2 SW5 -1 to 5 : Function Switch

*3 Ambient temp. of ZUBADAN Flash Injection becomes effective.
 The black square (■) indicates a switch position.

Ambient temp.	SW9-3,4 *4	Ambient temp.	SW9-3,4 *4
3°C or less (Initial setting)	ON OFF [■] [■] [■] [■] 1 2 3 4	-3°C or less	ON OFF [■] [■] [■] [■] 1 2 3 4
0°C or less	ON OFF [■] [■] [■] [■] 1 2 3 4	-6°C or less	ON OFF [■] [■] [■] [■] 1 2 3 4

*4 SW9-1 to 2 : Function Switch

PUHZ-SHW112YHAR4.UK
 PUHZ-SHW112YHAR4-BS.UK

PUHZ-SHW140YHAR4.UK
 PUHZ-SHW140YHAR4-BS.UK

PUHZ-SHW140YHAR5.UK
 PUHZ-SHW140YHAR5-BS.UK

SYMBOL	NAME	SYMBOL	NAME	SYMBOL	NAME
TB1	Terminal Block <Power Supply>	TH33	Thermistor <Ref. check>	SW5	Switch <Function Switch, Model Select>
TB2	Terminal Block <Indoor/Outdoor>	TH34	Thermistor <Comp. Surface>	SW6	Switch <Model Select>
MC	Motor for Compressor	LEV-A, LEV-B, LEV-C	Linear Expansion Valve	SW7	Switch <Function Switch>
MF1, MF2	Fan Motor	ACL1, ACL2, ACL3, ACL4	Reactor	SW8	Switch <Function Switch>
21S4	Solenoid Valve (4-Way Valve)	CY1, CY2	Capacitor	SW9	Switch <Function Switch>
63H	High Pressure Switch	CK	Capacitor	SWP	Switch <Pump Down>
63L	Low Pressure Switch	RS	Rush Current Protect Resistor	CN31	Connector <Emergency Operation>
63HS	High Pressure Sensor	P. B.	Power Circuit Board	CNDM	Connector <Connection for Option>
TH3	Thermistor <Liquid>	N. F.	Noise Filter Circuit Board	SV1/CH	Connector <Connection for Option>
TH4	Thermistor <Discharge>	CONV. B.	Converter Circuit Board	SV3/SS	Connector <Connection for Option>
TH6	Thermistor <2-Phase Pipe>	C. B.	Controller Circuit Board	CNM	Connector <Connection for Option>
TH7	Thermistor <Ambient>	SW1	Switch <Manual Defrost, Defect History Record Reset, Refrigerant Address>	F1, F2, F3, F4	Fuse <T6.3AL250V>
TH8	Thermistor <Heat Sink>	SW4	Switch <Test Operation>		
TH32	Thermistor <Suction>				

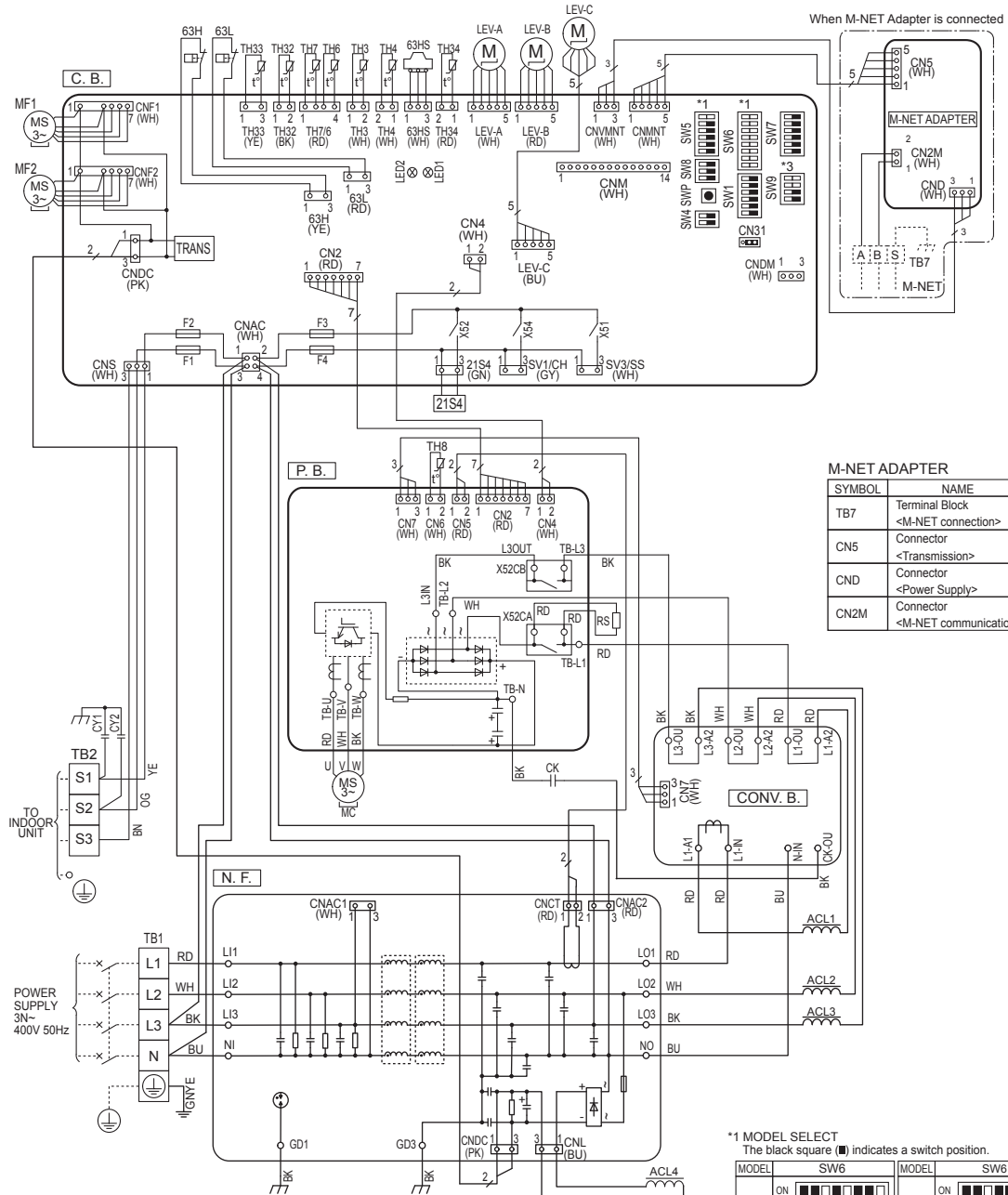

M-NET ADAPTER

SYMBOL	NAME
TB7	Terminal Block <M-NET connection>
CN5	Connector <Transmission>
CND	Connector <Power Supply>
CN2M	Connector <M-NET communication>

*3 Ambient temp. of ZUBADAN Flash Injection becomes effective.
 The black square (■) indicates a switch position.

Ambient temp.	SW9-3, 9-4 *4	Ambient temp.	SW9-3, 9-4 *4	Ambient temp.	SW9-3, 9-4 *4	Ambient temp.	SW9-3, 9-4 *4
3°C or less (Default setting)	ON OFF ■■■■ 1 2 3 4	0°C or less	ON OFF ■■■■ 1 2 3 4	-3°C or less	ON OFF ■■■■ 1 2 3 4	-6°C or less	ON OFF ■■■■ 1 2 3 4

*4 SW9-1 to 2 : Function Switch

*1 MODEL SELECT
 The black square (■) indicates a switch position.

MODEL	SW6	MODEL	SW6
112Y	ON OFF ■■■■ 1 2 3 4 5 6 7 8 SW5-6 *2	140Y	ON OFF ■■■■ 1 2 3 4 5 6 7 8 SW5-6 *2
	ON OFF ■■■■ 1 2 3 4 5 6		ON OFF ■■■■ 1 2 3 4 5 6

*2 SW5 -1 to 5 : Function Switch

FIELD ELECTRICAL WIRING (power wiring specifications)

Outdoor unit model		SHW80V	SHW112V	SHW112, 140Y
Outdoor unit power supply		~N (single), 50 Hz, 230 V	~N (single), 50 Hz, 230 V	3N~ (3 ph 4-wires), 50 Hz, 400 V
Outdoor unit input capacity Main switch (Breaker)		*1 32 A	40 A	16 A
Wiring Wire No. × Wire size (mm ²)	Outdoor unit power supply	3 × Min. 4	3 × Min. 6	5 × Min. 1.5
	Indoor unit-Outdoor unit	*2 3 × 1.5 (Polar)	3 × 1.5 (Polar)	3 × 1.5 (Polar)
	Indoor unit-Outdoor unit earth	*2 1 × Min. 1.5	1 × Min. 1.5	1 × Min. 1.5
	Remote controller-Indoor unit	*3 2 × 0.3 (Non-polar)	2 × 0.3 (Non-polar)	2 × 0.3 (Non-polar)
Circuit rating	Outdoor unit L-N (single)	*4 230 V AC	230 V AC	230 V AC
	Outdoor unit L1-N, L2-N, L3-N (3 phase)			
	Indoor unit-Outdoor unit S1-S2	*4 230 V AC	230 V AC	230 V AC
	Indoor unit-Outdoor unit S2-S3	*4 24 V DC	24 V DC	24 V DC
	Remote controller-Indoor unit	*4 12 V DC	12 V DC	12 V DC

*1. A breaker with at least 3.0 mm contact separation in each pole shall be provided. Use earth leakage breaker (NV).

Make sure that the current leakage breaker is one compatible with higher harmonics.

Always use a current leakage breaker that is compatible with higher harmonics as this unit is equipped with an inverter.

The use of an inadequate breaker can cause the incorrect operation of inverter.

*2. (SHW80-140)

Maximum 45 m

If 2.5 mm² is used, maximum 50 m.

If 2.5 mm² is used and S3 is separated, maximum 80 m.

*3. The 10 m wire is attached in the remote controller accessory.

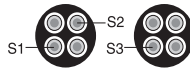

*4. The figures are NOT always against the ground.

S3 terminal has 24 V DC against S2 terminal. However between S3 and S1, these terminals are NOT electrically insulated by the transformer or other device.

Notes: 1. Wiring size must comply with the applicable local and national codes.

2. Power supply cables and the cables between Interface unit/Flow temp. controller and outdoor unit shall not be lighter than polychloroprene sheathed flexible cables. (Design 60245 IEC 57)

3. Be sure to connect the cables between Interface unit/Flow temp. controller and outdoor unit directly to the units (no intermediate connections are allowed).

Intermediate connections may result in communication errors. If water enters at the intermediate connection point, it may cause insufficient insulation to ground or a poor electrical contact.

(If an intermediate connection is necessary, be sure to take measures to prevent water from entering the cables.)

4. Install an earth line longer than power cables.

5. Do not construct a system with a power supply that is turned ON and OFF frequently.

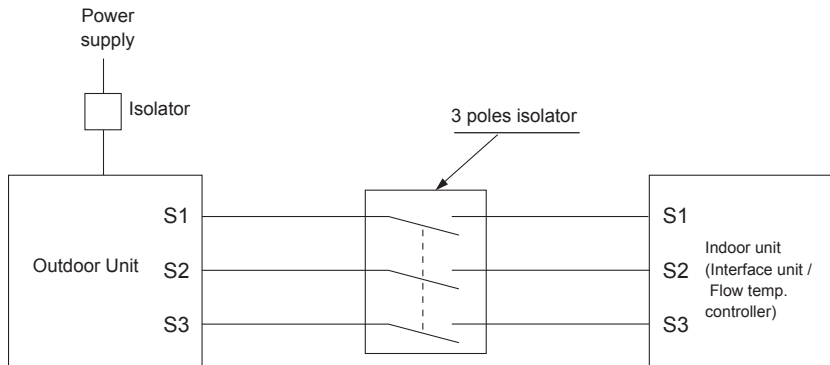

Warning:

- In case of A-control wiring, there is high voltage potential on the S3 terminal caused by electrical circuit design that has no electrical insulation between power line and communication signal line. Therefore, please turn off the main power supply when servicing. And do not touch the S1, S2, S3 terminals when the power is energized. If isolator should be used between indoor unit and outdoor unit, please use 3-pole type.

Never splice the power cable or the indoor-outdoor connection cable, otherwise it may result in smoke emission, a fire or communication failure.

9

REFRIGERANT SYSTEM DIAGRAM

- | | | | |
|------------------------|------------------------|------------------------|------------------------|
| PUHZ-SHW80VHA | PUHZ-SHW80VHAR2.UK | PUHZ-SHW80VHAR3.UK | PUHZ-SHW80VHAR4.UK |
| PUHZ-SHW112VHA | PUHZ-SHW112VHAR2.UK | PUHZ-SHW112VHAR3.UK | PUHZ-SHW112VHAR4.UK |
| PUHZ-SHW112YHA | PUHZ-SHW112YHAR2.UK | PUHZ-SHW112YHAR3.UK | PUHZ-SHW112YHAR4.UK |
| PUHZ-SHW112YHAR1 | PUHZ-SHW112YHAR2-BS.UK | PUHZ-SHW112YHAR3-BS.UK | PUHZ-SHW112YHAR4-BS.UK |
| PUHZ-SHW140YHA | PUHZ-SHW140YHAR2.UK | PUHZ-SHW140YHAR3.UK | PUHZ-SHW140YHAR4.UK |
| PUHZ-SHW140YHAR1 | PUHZ-SHW140YHAR2-BS.UK | PUHZ-SHW140YHAR3-BS.UK | PUHZ-SHW140YHAR4-BS.UK |
| PUHZ-SHW140YHAR5.UK | | | |
| PUHZ-SHW140YHAR5-BS.UK | | | |

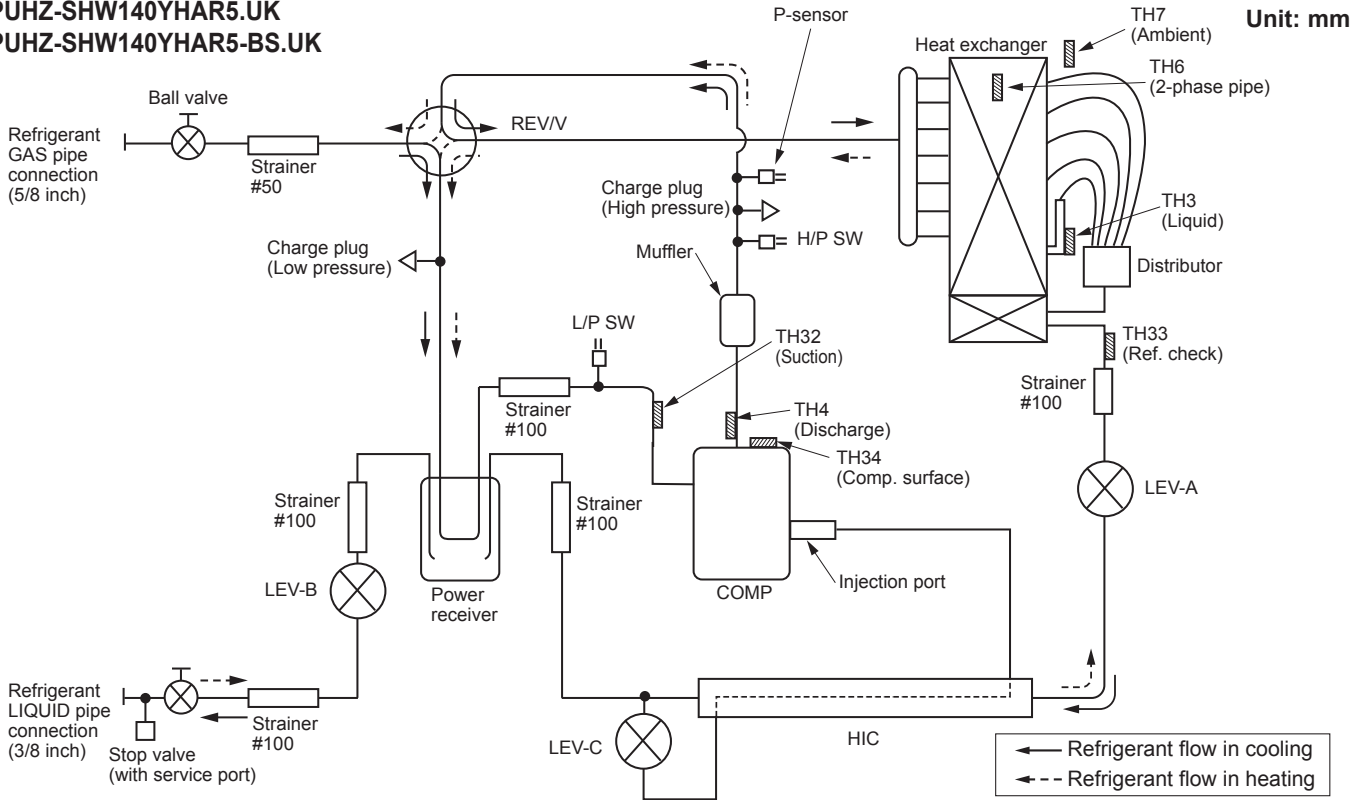

Symbol	Parts name	Detail
COMP	Compressor	DC inverter scroll compressor (Mitsubishi Electric Corporation)
H/P SW	High pressure switch (63H)	For protection (OFF: 4.15MPa)
L/P SW	Low pressure switch (63L)	For protection (OFF: -0.03MPa)
REV/V	Reversing (4-way) valve (21S4)	Change the refrigerant circuit (Heating / Cooling) and for Defrosting
Charge plug	Charge plug	High pressure/Low pressure/For production test use
P-Sensor	Pressure sensor (63HS)	For calculation of the condensing temperature from high pressure
LEV-A	Linear expansion valve -A	Heating:Secondary LEV Cooling:Primary LEV
LEV-B	Linear expansion valve -B	Heating:Primary LEV Cooling:Secondary LEV
LEV-C	Linear expansion valve -C	For HIC (heating only)
TH32	Suction temperature thermistor	For LEV control
TH33	Refrigerant leakage detection (Ref. check) thermistor	For refrigerant leakage detection
TH3	Liquid temperature thermistor	Heating:Evaporating temperature Cooling:Sub cool liquid temperature
TH4	Discharge temperature thermistor	For LEV control and for compressor protection
TH6	2-phase pipe temperature thermistor	Outdoor 2-phase pipe temperature
TH7	Ambient temperature thermistor	For fan control and for compressor frequency control
TH34	Comp. surface temperature thermistor	For protection
Power Receiver	Power Receiver	For accumulation of refrigerant
HIC	Heat interchange circuit	For high heating capacity
Plate HEX	Plate Heat Exchanger	MWA2-38PA (MITSUBISHI)
TH1	Outlet water temperature thermistor	For flow temp. controller
TH2	Liquid pipe temperature thermistor	For flow temp. controller

<Reference>
System example

9-1. REFRIGERANT COLLECTING (PUMP DOWN)

When relocating or disposing of the indoor/outdoor unit, pump down the system following the procedure below so that no refrigerant is released into the atmosphere.

- ① Turn off the power supply (circuit breaker).
- ② Connect the low pressure valve on the gauge manifold to the charge plug (low pressure side) on the outdoor unit.
- ③ Close the liquid stop valve completely.
- ④ Supply power (circuit breaker).
 - When power is supplied, make sure that “CENTRALLY CONTROLLED” is not displayed on the remote controller. If “CENTRALLY CONTROLLED” is displayed, the refrigerant collecting (pump down) cannot be completed normally.
 - Startup of the indoor-outdoor communication takes about 3 minutes after the power (circuit breaker) is turned on. Start the pump-down operation 3 to 4 minutes after the power (circuit breaker) is turned on.
- ⑤ Perform the refrigerant collecting operation (cooling test run).
 - Push the pump-down SWP switch (push-button type) on the control board of the outdoor unit. The compressor and ventilators (indoor and outdoor units) start operating (refrigerant collecting operation begins). (LED1 and LED2 on the control board of the outdoor unit are lit.)
 - Only push the pump-down SWP switch if the unit is stopped. However, even if the unit is stopped and the pump-down SWP switch is pushed less than 3 minutes after the compressor stops, the refrigerant collecting operation cannot be performed. Wait until the compressor has been stopped for 3 minutes and then push the pump-down SWP switch again.
- ⑥ Fully close the ball valve on the gas pipe side of the outdoor unit when the pressure gauge on the gauge manifold shows 0.05 to 0 MPa [Gauge] (approx. 0.5 to 0 kgf/cm²) and quickly stop the air conditioner.
 - Because the unit automatically stops in about 3 minutes when the refrigerant collecting operation is completed (LED1 off, LED2 lit), be sure to quickly close the gas ball valve. However, if LED1 is lit, LED2 is off, and the unit is stopped, open the liquid stop valve completely, close the valve completely after 3 minutes or more have passed, and then repeat step ⑤. (Open the gas ball valve completely.)
 - If the refrigerant collecting operation has been completed normally (LED1 off, LED2 lit), the unit will remain stopped until the power supply is turned off.
 - Note that when the extension piping is very long with a large refrigerant amount, it may not be possible to perform a pump-down operation. In this case, use refrigerant recovery equipment to collect all of the refrigerant in the system.
- ⑦ Turn off the power supply (circuit breaker), remove the gauge manifold, and then disconnect the refrigerant pipes.

⚠ Warning:

When pumping down the refrigerant, stop the compressor before disconnecting the refrigerant pipes.

- **If the refrigerant pipes are disconnected while the compressor is operating and the stop valve (ball valve) is open, the pressure in the refrigeration cycle could become extremely high if air is drawn in, causing the pipes to burst, personal injury, etc.**

9-2. UNIT REPLACEMENT OPERATION

When reusing the existing pipes that carried R22 refrigerant for the SW75/100/120 models, replacement operation must be performed before performing a test run.

- ① If new pipes are used, these procedures are not necessary.
- ② If existing pipes that carried R22 refrigerant are used for the SW75/100/120 models, these procedures are not necessary. (The replacement operation cannot be performed.)
- ③ During replacement operation, “C5” is displayed on “A-Control Service Tool (PAC-SK52ST)”. (This is applied to only SW75/100/120 models.)

9-3. START AND FINISH OF TEST RUN

- Operation from the indoor unit
Execute the test run using the installation manual for the indoor unit.
- Operation from the outdoor unit
By using the DIP switch SW4 on the control board of outdoor unit, test run can be started and finished, and its operation mode (cooling/heating) can be set up.

- ① Set the operation mode (cooling/heating) using SW4-2.
- ② Turn on SW4-1 to start test run with the operation mode set by SW4-2.
- ③ Turn off SW4-1 to finish the test run.

- There may be a faint knocking sound around the machine room after power is supplied, but this is no problem with product because the linear expansion pipe is just moving to adjust opening pulse.
- There may be a knocking sound around the machine room for several seconds after compressor starts operating. However, this is not a problem with product because it is generated by the check valve itself due to a small pressure difference in the refrigerant circuit.

Note:
The operation mode cannot be changed by SW4-2 during test run. (To change test run mode, stop the unit by SW4-1, change the operation mode and restart the test run by SW4-1.)

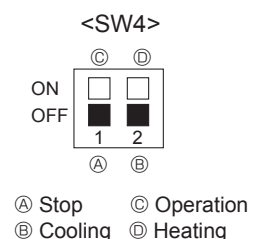

10-1. TROUBLESHOOTING

<Check code displayed by self-diagnosis and actions to be taken for service (summary)>

Present and past check codes are logged, and they can be displayed on the control board of outdoor unit. Actions to be taken for service, which depends on whether or not the trouble is reoccurring in the field, are summarized in the table below. Check the contents below before investigating details.

Unit conditions at service	Check code	Actions to be taken for service (summary)
The trouble is reoccurring.	Displayed	Judge what is wrong and take a corrective action according to "10-4. SELF-DIAGNOSIS ACTION TABLE".
	Not displayed	Conduct troubleshooting and ascertain the cause of the trouble according to "10-5. TROUBLESHOOTING OF PROBLEMS".
The trouble is not reoccurring.	Logged	①Consider the temporary defects such as the work of protection devices in the refrigerant circuit including compressor, poor connection of wiring, noise, etc. Re-check the symptom, and check the installation environment, refrigerant amount, weather when the trouble occurred, matters related to wiring, etc. ②Reset check code logs and restart the unit after finishing service. ③There is no abnormality in electrical component, controller board, remote controller, etc.
	Not logged	①Re-check the abnormal symptom. ②Conduct troubleshooting and ascertain the cause of the trouble according to "10-5. TROUBLESHOOTING OF PROBLEMS". ③Continue to operate unit for the time being if the cause is not ascertained. ④There is no abnormality concerning of parts such as electrical component, controller board, remote controller, etc.

10-2. CHECK POINT UNDER TEST RUN

10-2-1. Before test run

(1) Before test run

- After installation of indoor and outdoor units, piping work and electric wiring work, re-check that there is no refrigerant leakage, loosened connections and incorrect polarity.
- Measure impedance between the ground and the power supply terminal block (L, N) on the outdoor unit by 500 V Megger and check that it is 1.0 MΩ or over.
- Do not use 500V Megger to indoor/outdoor connecting wire terminal block (S1, S2, S3) and remote controller terminal block (1, 2). This may cause malfunction.
- Make sure that test run switch (SW4) is set to OFF before turning on power supply.
- Turn on power supply for 12 hours before test run in order to protect compressor.
- For specific models which requires higher ceiling settings or power failure automatic recovery, make proper changes of settings referring to the description of "Selection of Functions through Remote Controller".
Make sure to read operation manual before test run. (Especially items to secure safety.)

10-2-2. Test run for wired remote controller<PAR-3xMAA ("x" represents 0 or later)>

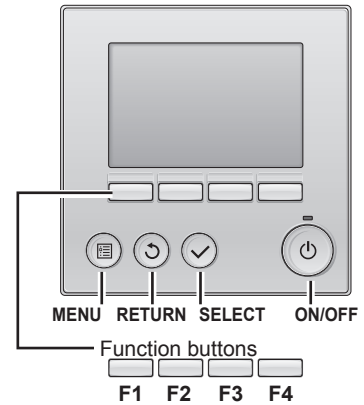

① Select "Service" from the Main menu, and press the button.



Select "Test run" with the **F1** or **F2** button, and press the button.

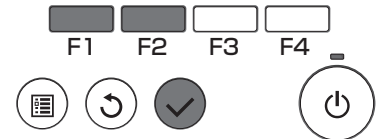
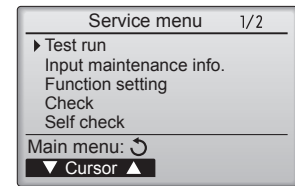

② Select "Test run" with the **F1** or **F2** button, and press the button.

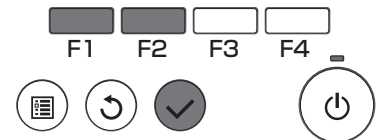
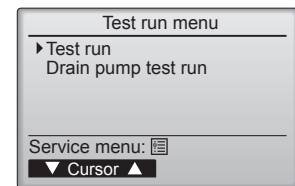

Test run operation

Press the **F1** button to go through the operation modes in the order of "Cool and Heat".

Cool mode: Check the cold air blow off.
Heat mode: Check the heat blow off.



Press the button and open the Vane setting screen.

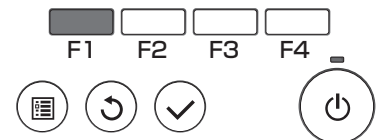
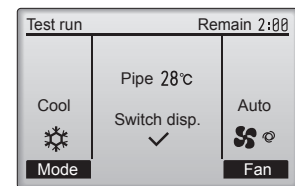

Auto vane check

Check the auto vane with the **F1** **F2** buttons.
• Check the operation of the outdoor unit's fan.



Press the button to return to "Test run operation".



Press the button.

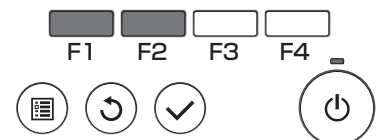
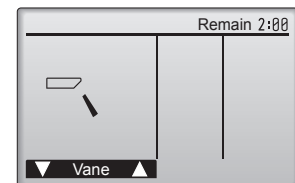

When the test run is completed, the "Test run menu" screen will appear.
• The test run will automatically stop after 2 hours.

<Error information>

**When an error occurs, the following screen will appear.
Check the error status, stop the operation, and consult your dealer.**

- ① Check code, error unit, refrigerant address, unit model name, and serial number will appear.
The model name and serial number will appear only if the information have been registered.

Press the **F1** or **F2** button to go to the next page.

Contact information (dealer's phone number) will appear if the information have been registered.

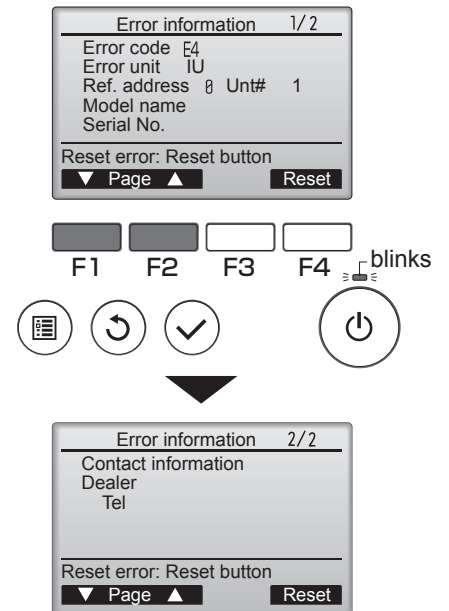

- ② Press the **F4** button or the  button to reset the error that is occurring.

Errors cannot be reset while the ON/OFF operation is prohibited.

Select "OK" with the **F4** button.

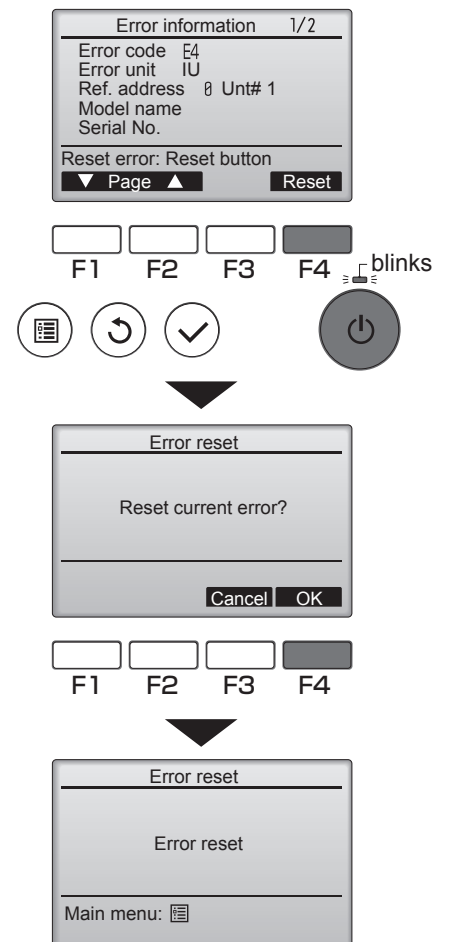

Navigating through the screens

- To go back to the Main menu  button

<Checking the error information>

While no errors are occurring, page 2/2 of the error information can be viewed by selecting "Error information" from the Main menu. Errors cannot be reset from this screen.

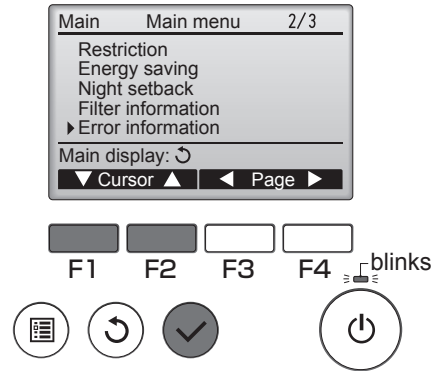

<Error history>

① Select "Service" from the Main menu, and press the button.



Select "Check" with the **F1** or **F2** button, and press the button.

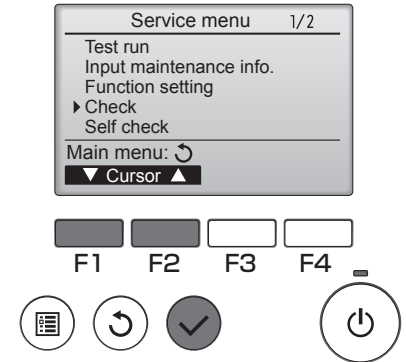

② Select "Error history" with the **F1** or **F2** button, and press the button.

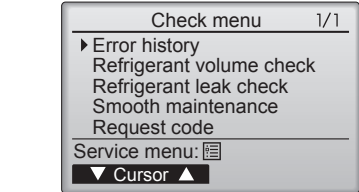

Error history

③ Select "Error history" from the Check menu, and press the button to view up to 16 error history records.

Four records are shown per page, and the top record on the first page indicates the latest error record.

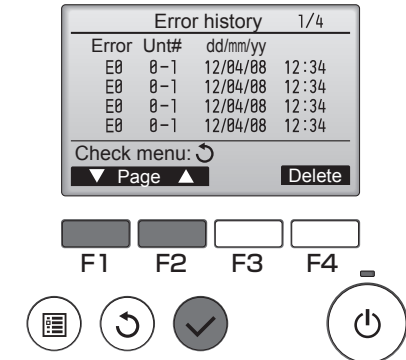

Deleting the error history

④ To delete the error history, press the **F4** button (Delete) on the screen that shows error history.

A confirmation screen will appear asking if you want to delete the error history.



Press the **F4** button (OK) to delete the history.



"Error history deleted" will appear on the screen.

Press the button to go back to the Check menu screen.

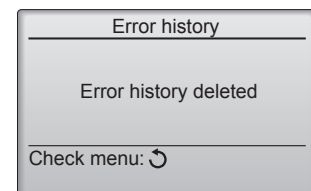
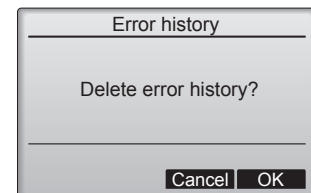

10-2-3. Test run for wired remote controller <PAR-21MAA>

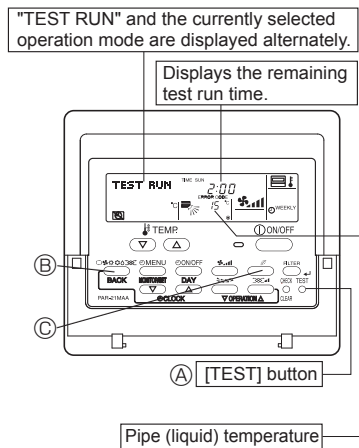

Operating procedures	
1. Turn on the main power supply.	While the room temperature display on the remote controller is "PLEASE WAIT", the remote controller is disabled. Wait until "PLEASE WAIT" disappears before using remote controller. "PLEASE WAIT" appears for about 2 minutes after power supply is turned on. *
2. Press (A) [TEST] button twice.	The [TEST RUN] appears on the screen.
3. Press (B) [OPERATION SWITCH] button.	Cooling mode: Check if cool air blows and water is drained. Heating mode: Check if warm air blows. (It takes a little while until warm air blows.)
4. Press (C) [AIR DIRECTION] button.	Check for correct motion of auto-vanes.
5. Check the outdoor unit fan for correct running.	The outdoor unit features automatic capacity control to provide optimum fan speeds. Therefore, the fan keeps running at a low speed to meet the current outside air condition unless it exceeds its available maximum power. Then, in actuality, the fan may stop or run in the reverse direction depending on the outside air, but this does not mean malfunction.
6. Press the [ON/OFF] button to reset the test run in progress.	
7. Register the contact number.	

- In case of test run, the OFF timer will be activated, and the test run will automatically stop after 2 hours.
- The room temperature display section shows the pipe temperature of indoor units during the test run.
- Check that all the indoor units are running properly in case of simultaneous twin operation. Malfunctions may not be displayed regardless of incorrect wiring.
 - *After turning on the power supply, the system will go into startup mode, "PLEASE WAIT" will blink on the display section of the room temperature, and lamp (green) of the remote controller will flash.
 - As to INDOOR BOARD LED, LED1 will be lit up, LED2 will either be lit up in case the address is 0 or turned off in case the address is not 0. LED3 will blink.
 - As to OUTDOOR BOARD LED, LED1 (green) and LED2 (red) will be lit up. (After the startup mode of the system finishes, LED2 (red) will be turned off.)
 - In case OUTDOOR BOARD LED is digital display, [] and [] will be displayed alternately every second.
- If one of the above operations does not function correctly, the causes written below should be considered. Find causes from the symptoms.
 - The below symptoms are under test run mode. "startup" in the table means the display status of (*) written above.

Symptoms in test run mode		Cause
Remote Controller Display	OUTDOOR BOARD LED Display < > indicates digital display.	
Remote controller displays "PLEASE WAIT", and cannot be operated.	After "startup" is displayed, only green lights up. <00>	• After power is turned on, "PLEASE WAIT" is displayed for 2 minutes during system startup. (Normal)
After power is turned on, "PLEASE WAIT" is displayed for 3 minutes, then check code is displayed.	After "startup" is displayed, green(once) and red(once) blink alternately. <F1>	• Incorrect connection of outdoor terminal block (L1, L2, L3 and S1, S2, S3.)
	After "startup" is displayed, green(once) and red(twice) blink alternately. <F3, F5, F9>	• Outdoor unit's protection device connector is open.
No display appears even when remote controller operation switch is turned on. (Operation lamp does not light up.)	After "startup" is displayed, green(twice) and red(once) blink alternately. <EA, Eb>	• Incorrect wiring between the indoor and outdoor unit (Polarity is wrong for S1, S2, S3.)
	After "startup" is displayed, only green lights up. <00>	• Remote controller transmission wire is short. • There is no outdoor unit of address 0. (Address is other than 0.) • Remote controller transmission wire is open.
Display appears but soon disappears even when remote controller is operated.	After "startup" is displayed, only green lights up. <00>	• After canceling function selection, operation is not possible for about 30 seconds. (Normal)

Note: Press the remote controller's [CHECK] button twice to perform self-diagnosis. See the table below for the contents of LCD display.











LCD	Contents of inferior phenomena	LCD	Contents of inferior phenomena
P1	Abnormality of room temperature thermistor	U1-UP	Malfunction outdoor unit
P2	Abnormality of pipe temperature thermistor/Liquid	F3-F9	Malfunction outdoor unit
P4	Abnormality of drain sensor/ Float switch connector open	E0-E5	Remote controller transmitting error
P5	Drain overflow protection is operating.	E6-EF	Indoor/outdoor unit communication error
P6	Freezing/overheating protection is operating.	----	No error history
P8	Abnormality of pipe temperature	FFFF	No applied unit
P9	Abnormality of pipe temperature thermistor/Cond./Eva	PA	Forced compressor stop(due to water leakage abnormality)
Fb	Abnormality of indoor controller board	PL	Abnormality of refrigerant

See the table below for details of the LED display (LED 1, 2, 3) on the indoor controller board.

LED1 (microprocessor power supply)	Lights when power is supplied.
LED2 (remote controller)	Lights when power is supplied for wired remote controller. The indoor unit should be connected to the outdoor unit with address "0" setting.
LED3 (indoor/outdoor communication)	Flashes when indoor and outdoor unit are communicating.

10-2-4. Test run for wireless remote controller

Measure an impedance between the power supply terminal block on the outdoor unit and ground with a 500 V Megger and check that it is equal to or greater than 1.0 MΩ.

- ① Turn on the main power to the unit.
- ② Press the  button twice continuously.
(Start this operation from the status of remote controller display turned off.)
A  and current operation mode are displayed.
- ③ Press the  () button to activate  mode, then check whether cool air blows out from the unit.
- ④ Press the  () button to activate  mode, then check whether warm air blows out from the unit.
- ⑤ Press the  button and check whether strong air blows out from the unit.
- ⑥ Press the  button and check whether the auto vane operates properly.
- ⑦ Press the ON/OFF button to stop the test run.

Note:

- Point the remote controller towards the indoor unit receiver while following steps ② to ⑦.
- It is not possible to run in FAN, DRY or AUTO mode.

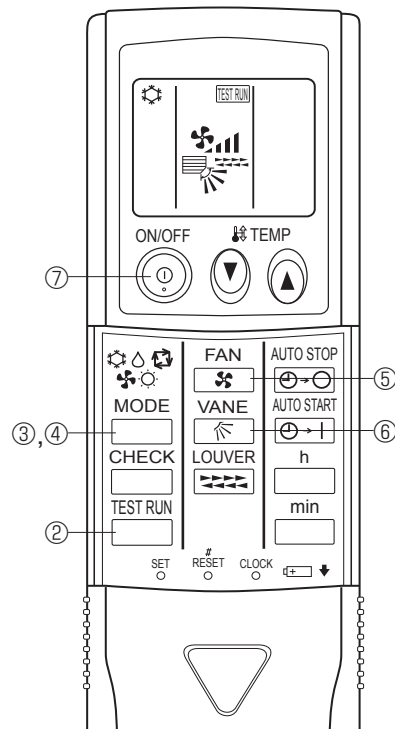

10-3. HOW TO PROCEED "SELF-DIAGNOSIS"

10-3-1. Self-diagnosis <PAR-3xMAA ("x" represents 0 or later)>

① Select "Service" from the Main menu, and press the  button.



Select "Self check" with the **F1** or **F2** button, and press the  button.

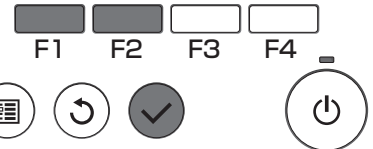
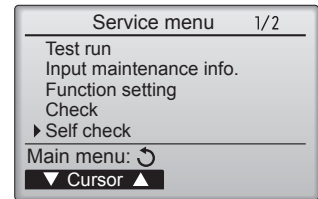

② With the **F1** or **F2** button, enter the refrigerant address, and press the  button.

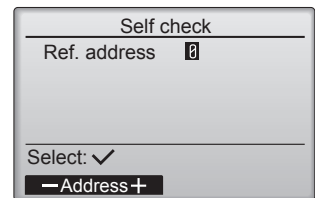

③ Check code, unit number, attribute will appear.
"-" will appear if no error history is available.

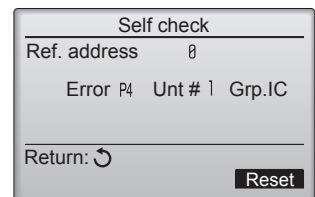

When there is no error history

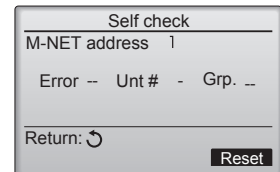

④ Resetting the error history.

Press the **F4** button (Reset) on the screen that shows the error history.



A confirmation screen will appear asking if you want to delete the error history.



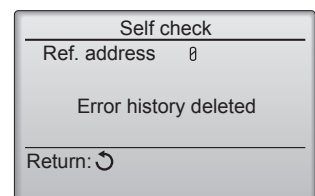
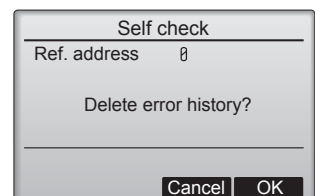

Press the **F4** button (OK) to delete the error history.

If deletion fails, "Request rejected" will appear.
"Unit not exist" will appear if no indoor units that are correspond to the entered address are found.





Navigating through the screens

- To go back to the Service menu  button
- To return to the previous screen  button

10-3-2. Remote controller check <PAR-3xMAA ("x" represents 0 or later)>



If operations cannot be completed with the remote controller, diagnose the remote controller with this function.

- ① Select "Service" from the Main menu, and press the  button.

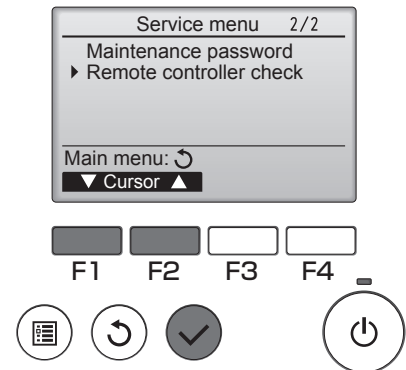
Select "Remote controller check" with the **F1** or **F2** button, and press the  button.



- ② Select "Remote controller check" from the Service menu, and press the  button to start the remote controller check and see the check results.

To cancel the remote controller check and exit the Remote controller check menu screen, press the  or the  button.

The remote controller will not reboot itself.

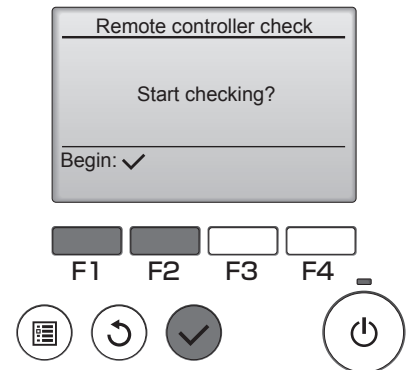

- ③
- OK: No problems are found with the remote controller. Check other parts for problems.
 - E3, 6832: There is noise on the transmission line, or the indoor unit or another remote controller is faulty. Check the transmission line and the other remote controllers.
 - NG (ALL0, ALL1): Send-receive circuit fault. Remote controller needs replacing.
 - ERC: The number of data errors is the discrepancy between the number of bits in the data transmitted from the remote controller and that of the data that was actually transmitted over the transmission line. If data errors are found, check the transmission line for external noise interference.

Remote controller check results screen

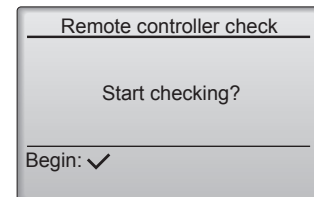

If the  button is pressed after the remote controller check results are displayed, remote controller check will end, and the remote controller will automatically reboot itself.

Check the remote controller display and see if anything is displayed (including lines). Nothing will appear on the remote controller display if the correct voltage (8.5–12 V DC) is not supplied to the remote controller. If this is the case, check the remote controller wiring and indoor units.

10-3-3. Self-diagnosis <PAR-21MAA>

If a problem occurs in the air conditioner, the indoor and outdoor units will stop, and the problem is shown in the remote controller display.

- ① [CHECK] and the refrigerant address are displayed on the temperature display, and the check code and unit number are displayed alternately as shown below. (If the outdoor unit is malfunctioning, the unit number will be "00".)
- ② In the case of group control, for which one remote controller controls multiple refrigerant systems, the refrigerant address and check code of the unit that first experienced trouble (i.e., the unit that transmitted the check code) will be displayed.
- ③ To clear the check code, press the **ON/OFF** button.

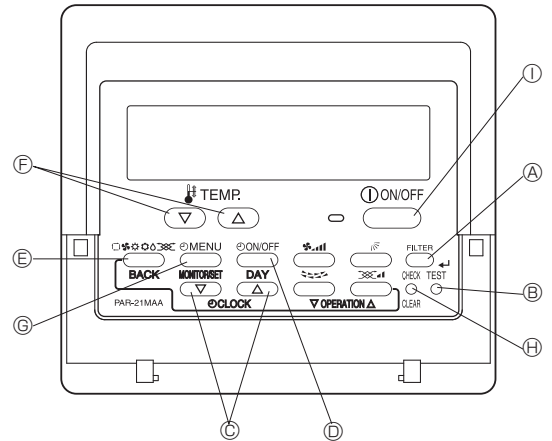

(Alternating Display)

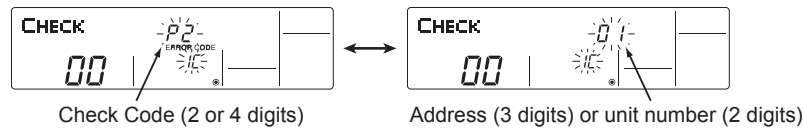

When using remote-/local-controller combined operation, cancel the check code after turning off remote operation. During central control by a MELANS controller, cancel the check code by pressing the **ON/OFF** button.

10-3-4. Self-diagnosis during maintenance or service <PAR-21MAA>

Since each unit has a function that stores check codes, the latest check code can be recalled even if it is cancelled by the remote controller or power is turned off.

Check the error history for each unit using the remote controller.

- ① Switch to self-diagnosis mode.

- ② Press the **CHECK** button twice within 3 seconds. The display content will change as shown below.

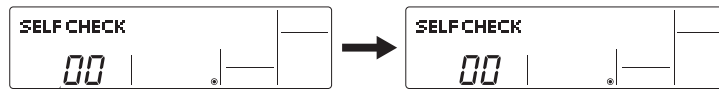

Unit number or refrigerant address to be diagnosed

- ② Set the unit number or refrigerant address you want to diagnose.

- ③ Press the [TEMP] buttons (**TEMP** and **TEMP**) to select the desired number or address. The number (address) changes between [01] and [50] or [00] and [15].

The refrigerant address will begin to blink approximately 3 seconds after being selected and the self-diagnosis process will begin.

- ③ Display self-diagnosis results.

<When there is error history>

(For the definition of each check code, refer to the indoor unit's installation manual or service handbook.)

(Alternating Display)

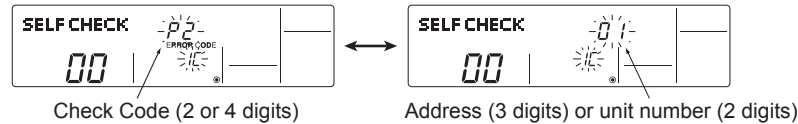

<When there is no error history>

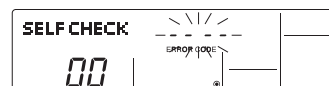

<When there is no corresponding unit>

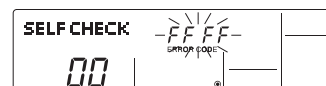

- ④ Reset the error history.

Display the error history in the diagnosis result display screen (see step ③).



- ④ Press the **ON/OFF** button twice within 3 seconds. The self-diagnosis address or refrigerant address will blink.

When the error history is reset, the display will look like the one shown below. However, if you fail to reset the error history, the error content will be displayed again.

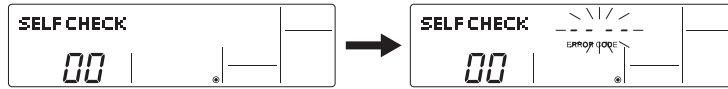

- ⑤ Cancel self-diagnosis.

Self-diagnosis can be cancelled by the following 2 methods.

- ⑥ Press the **CHECK** button twice within 3 seconds. → Self-diagnosis will be cancelled and the screen will return to the previous state in effect before the start of self-diagnosis.
- ⑦ Press the **ON/OFF** button. → Self-diagnosis will be cancelled and the indoor unit will stop.

10-3-5. Remote controller check <PAR-21MAA>

If the air conditioner cannot be operated from the remote controller, diagnose the remote controller as explained below.

- ① First, check that the power-on indicator is lit.
If the correct voltage (12 V DC) is not supplied to the remote controller, the indicator will not light.
If this occurs, check the remote controller's wiring and the indoor unit.

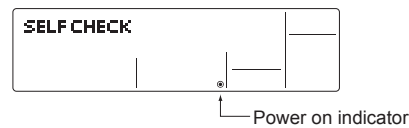

- ② Switch to the remote controller self-diagnosis mode.

- ⑥ Press the **CHECK** button for 5 seconds or more. The display content will change as shown below.

- ⑦ Press the **FILTER** button to start self-diagnosis.

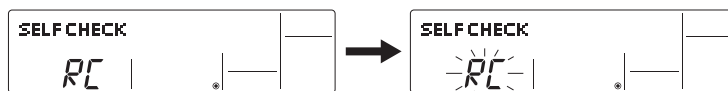

- ③ Remote controller self-diagnosis result

[When the remote controller is functioning correctly]



Check for other possible causes, as there is no problem with the remote controller.

[When the remote controller malfunctions]
(Error display 1) "NG" blinks. The remote controller's transmitting-receiving circuit is defective.

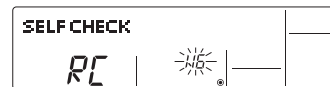

The remote controller must be replaced with a new one.

[Where the remote controller is not defective, but cannot be operated.]
(Error display 2) [E3], [6833] or [6832] blinks. Transmission is not possible.

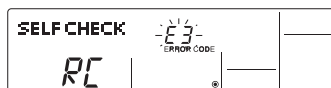

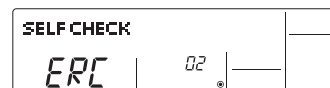

There might be noise or interference on the transmission path, or the indoor unit or other remote controllers are defective. Check the transmission path and other controllers.

(Error display 3) "ERC" and the number of data errors are displayed.
→ Data error has occurred.



The number of data errors is the difference between the number of bits sent from the remote controller and the number actually transmitted through the transmission path. If such a problem is occurring, the transmitted data is affected by noise, etc. Check the transmission path.

When the number of data errors is "02":
Transmission data from remote controller 
Transmission data on transmission path 

- ④ To cancel remote controller diagnosis

- ⑥ Press the **CHECK** button for 5 seconds or more. Remote controller diagnosis will be cancelled, "PLEASE WAIT" and operation lamp will blink. After approximately 30 seconds, the state in effect before the diagnosis will be restored.

10-3-6. Self-diagnosis <Wireless remote controller>

<In case of trouble during operation>

When a malfunction occurs to air conditioner, both indoor unit and outdoor unit will stop and operation lamp blinks to inform unusual stop.

<Malfunction-diagnosis method at maintenance service>

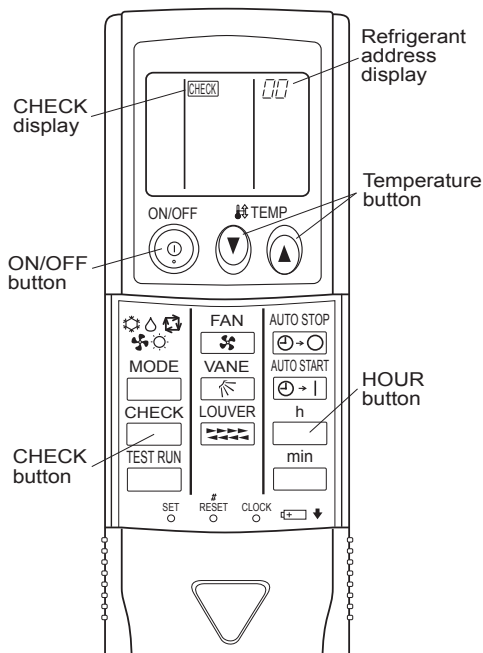

[Procedure]

1. Press the CHECK button twice.

- "CHECK" lights, and refrigerant address "00" blinks.
- Check that the remote controller's display has stopped before continuing.

2. Press the TEMP buttons.

- Select the refrigerant address of the indoor unit for the self-diagnosis.
- Note: Set refrigerant address using the outdoor unit's DIP switch (SW1). (For more information, see the outdoor unit installation manual.)

3. Point the remote controller at the sensor on the indoor unit and press the HOUR button.

- If an air conditioner error occurs, the indoor unit's sensor emits an intermittent buzzer sound, the operation lamp blinks, and the check code is output. (It takes 3 seconds at most for check code to appear.)

4. Point the remote controller at the sensor on the indoor unit and press the ON/OFF button.

- The check mode is cancelled.

- Refer to the following tables for details on the check codes.

[Output pattern A]

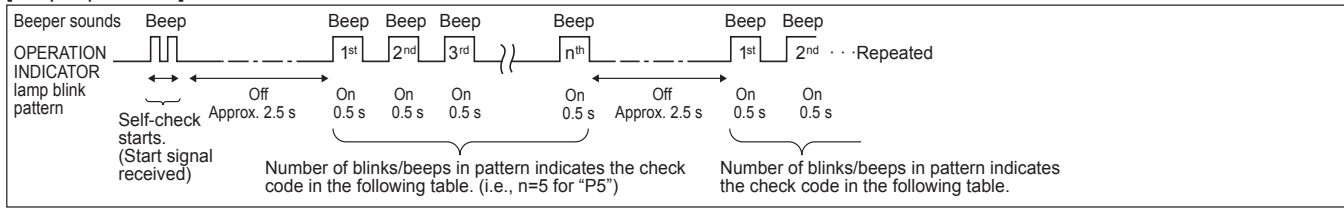

[Output pattern B]

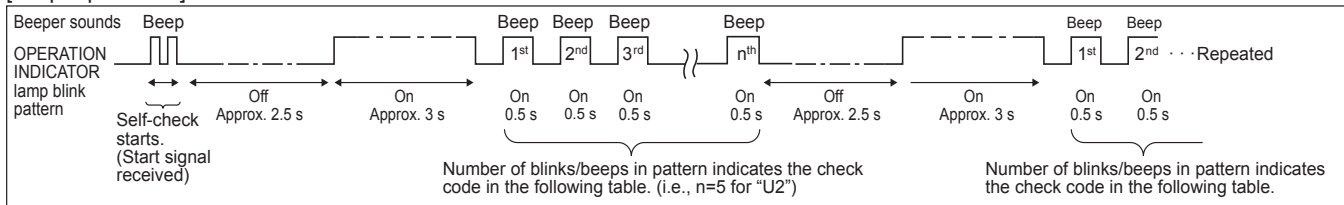

[Output pattern A] Errors detected by indoor unit

Wireless remote controller Beeper sounds/OPERATION INDICATOR lamp blinks (Number of times)	Wired remote controller Check code	Symptom	Remarks
1	P1	Intake sensor error	As for indoor unit, refer to indoor unit's service manual.
2	P2	Pipe (TH2) sensor error	
	P9	Pipe (TH5) sensor error	
3	E6, E7	Indoor/outdoor unit communication error	
4	P4	Drain sensor error/Float switch connector open	
5	P5	Drain pump error	
	PA	Forced compressor stop(due to water leakage abnormality)	
6	P6	Freezing/Overheating protection operation	
7	EE	Combination error between indoor and outdoor units	
8	P8	Pipe temperature error	
9	E4, E5	Remote controller signal receiving error	
10	-	-	
11	-	-	
12	Fb	Indoor unit control system error (memory error, etc.)	
14	PL	Abnormality of refrigerant circuit	
-	E0, E3	Remote controller transmission error	
-	E1, E2	Remote controller control board error	

[Output pattern B] Errors detected by unit other than indoor unit (outdoor unit, etc.)

Wireless remote controller Beeper sounds/OPERATION INDICATOR lamp blinks (Number of times)	Wired remote controller Check code	Symptom	Remarks
1	E9	Indoor/outdoor unit communication error (Transmitting error) (Outdoor unit)	For details, check the LED display of the outdoor controller board.
2	UP	Compressor overcurrent interruption	
3	U3, U4	Open/short of outdoor unit thermistors	
4	UF	Compressor overcurrent interruption (When compressor locked)	
5	U2	Abnormal high discharging temperature/insufficient refrigerant	
6	U1, Ud	Abnormal high pressure (63H operated)/Overheating protection operation	
7	U5	Abnormal temperature of heat sink	
8	U8	Outdoor unit fan protection stop	
9	U6	Compressor overcurrent interruption/Abnormal of power module	
10	U7	Abnormality of superheat due to low discharge temperature	
11	U9, UH	Abnormality such as overvoltage or voltage shortage and abnormal synchronous signal to main circuit/Current sensor error	
12	-	-	
13	-	-	
14	Others	Other errors (Refer to the technical manual for the outdoor unit.)	

- Notes: 1. If the beeper does not sound again after the initial 2 beeps to confirm the self-check start signal was received and the OPERATION INDICATOR lamp does not come on, there are no error records.
 2. If the beeper sounds 3 times continuously "beep, beep, beep (0.4 + 0.4 + 0.4 seconds)" after the initial 2 beeps to confirm the self-check start signal was received, the specified refrigerant address is incorrect.

10-4. SELF-DIAGNOSIS ACTION TABLE

<Abnormalities detected when the power is turned on>

Note: Refer to indoor unit section for code P and code E.

Check code	Abnormal point and detection method	Case	Judgment and action
None		<p>① No voltage is supplied to terminal block (TB1) of outdoor unit. a) Power supply breaker is turned off. b) Contact failure or disconnection of power supply terminal c) Open phase (L or N phase)</p> <p>② Electric power is not charged to power supply terminal of outdoor power circuit board. a) Contact failure of power supply terminal b) Open phase on the outdoor power circuit board</p> <p>③ Electric power is not supplied to outdoor controller circuit board. a) Disconnection of connector (CNDC)</p> <p>④ Disconnection of reactor (DCL or ACL)</p> <p>⑤ Disconnection of outdoor noise filter circuit board or parts failure in outdoor noise filter circuit board</p> <p>⑥ Defective outdoor power circuit board</p> <p>⑦ Defective outdoor controller circuit board</p>	<p>① Check following items. a) Power supply breaker b) Connection of power supply terminal block (TB1) c) Connection of power supply terminal block (TB1)</p> <p>② Check following items. a) Connection of power supply terminal block (TB1) b) Connection of terminal on outdoor power circuit board Check connection of the connector LI or NI. Refer to "10-9.TEST POINT DIAGRAM".</p> <p>③ Check connection of the connector (CNDC) on the outdoor controller circuit board. Check connection of the connector, CNDC on the outdoor power circuit board(V)/the noise filter(Y). Refer to "10-9.TEST POINT DIAGRAM".</p> <p>④ Check connection of reactor. (DCL or ACL) Refer to "10-9.TEST POINT DIAGRAM".</p> <p>⑤ a) Check connection of outdoor noise filter circuit board. b) Replace outdoor noise filter circuit board. Refer to "10-9.TEST POINT DIAGRAM".</p> <p>⑥ Replace outdoor power circuit board.</p> <p>⑦ Replace controller board (When items above are checked but the units cannot be repaired).</p>
F3 (5202)	<p>63L connector open Abnormal if 63L connector circuit is open for 3 minutes continuously after power supply.</p> <p>63L: Low pressure switch</p>	<p>① Disconnection or contact failure of 63L connector on outdoor controller circuit board</p> <p>② Disconnection or contact failure of 63L</p> <p>③ 63L is working due to refrigerant leakage or defective parts.</p> <p>④ Defective outdoor controller circuit board</p>	<p>① Check connection of 63L connector on outdoor controller circuit board. Refer to "10-9.TEST POINT DIAGRAM".</p> <p>② Check the 63L side of connecting wire.</p> <p>③ Check refrigerant pressure. Charge additional refrigerant. Check continuity by tester. Replace the parts if the parts are defective.</p> <p>④ Replace outdoor controller circuit board.</p>
F5 (5201)	<p>63H connector open Abnormal if 63H connector circuit is open for 3 minutes continuously after power supply.</p> <p>63H: High pressure switch</p>	<p>① Disconnection or contact failure of 63H connector on outdoor controller circuit board</p> <p>② Disconnection or contact failure of 63H</p> <p>③ 63H is working due to defective parts.</p> <p>④ Defective outdoor controller circuit board</p>	<p>① Check connection of 63H connector on outdoor controller circuit board. Refer to "10-9.TEST POINT DIAGRAM".</p> <p>② Check the 63H side of connecting wire.</p> <p>③ Check continuity by tester. Replace the parts if the parts are defective.</p> <p>④ Replace outdoor controller circuit board.</p>



Check Code	Abnormal point and detection method	Case	Judgment and action
F9 (4119)	<p>2 connector open Abnormal if both 63H and 63L connector circuits are open for three minutes continuously after power supply.</p> <p>63H: High pressure switch 63L: Low pressure switch</p>	<p>① Disconnection or contact failure of connector (63H,63L) on outdoor controller circuit board</p> <p>② Disconnection or contact failure of 63H, 63L</p> <p>③ 63H and 63L are working due to defective parts.</p> <p>④ Defective outdoor controller board</p>	<p>① Check connection of connector (63H,63L) on outdoor controller circuit board. Refer to "10-9.TEST POINT DIAGRAM".</p> <p>② Check the 63H and 63L side of connecting wire.</p> <p>③ Check continuity by tester. Replace the parts if the parts are defective.</p> <p>④ Replace outdoor controller circuit board.</p>
EA (6844)	<p>Indoor/outdoor unit connector miswiring, excessive number of units (4 units or more)</p> <p>1. Outdoor controller circuit board can automatically check the number of connected indoor units. Abnormal if the number cannot be checked automatically due to miswiring of indoor/outdoor unit connecting wire and etc. after power is turned on for 4 minutes.</p> <p>2. Abnormal if outdoor controller circuit board recognizes the number of connected indoor units as "4 units or more".</p>	<p>① Contact failure or miswiring of indoor/outdoor unit connecting wire</p> <p>② Diameter or length of indoor/outdoor unit connecting wire is out of specified capacity.</p> <p>③ 4 or more indoor units are connected to one outdoor unit.</p> <p>④ Defective transmitting receiving circuit of outdoor controller circuit board</p> <p>⑤ Defective transmitting receiving circuit of indoor controller board</p> <p>⑥ Defective indoor power board</p> <p>⑦ 2 or more outdoor units have refrigerant address "0" . (In case of group control)</p> <p>⑧ Noise has entered into power supply or indoor / outdoor unit connecting wire.</p>	<p>① Check disconnection or looseness or polarity of indoor/outdoor unit connecting wire of indoor and outdoor units.</p> <p>② Check diameter and length of indoor/outdoor unit connecting wire. Total wiring length: 80 m (including wiring connecting each indoor unit and between indoor and outdoor unit) Also check if the connection order of flat cable is S1, S2, S3.</p> <p>③ Check the number of indoor units that are connected to one outdoor unit. (If EA is detected)</p> <p>④-⑥ Turn the power off once, and on again to check. Replace outdoor controller circuit board, indoor controller board or indoor power board if abnormality occurs again.</p> <p>⑦ Check if refrigerant addresses (SW1-3 to SW1-6 on outdoor controller circuit board) are overlapping in case of group control system.</p> <p>⑧ Check transmission path, and remove the cause.</p>
Eb (6845)	<p>Miswiring of indoor/outdoor unit connecting wire (converse wiring or disconnection)</p> <p>Outdoor controller circuit board can automatically set the unit number of indoor units. Abnormal if the indoor unit number cannot be set within 4 minutes after power on because of miswiring (converse wiring or disconnection) of indoor/outdoor unit connecting wire.</p>	<p>① Contact failure or miswiring of indoor/outdoor unit connecting wire</p> <p>② Diameter or length of indoor/outdoor unit connecting wire is out of specified capacity.</p> <p>④ Defective transmitting receiving circuit of outdoor controller circuit board</p> <p>⑤ Defective transmitting receiving circuit of indoor controller board</p> <p>⑥ Defective indoor power board</p> <p>⑦ 2 or more outdoor units have refrigerant address "0" . (In case of group control)</p> <p>⑧ Noise has entered into power supply or indoor/outdoor unit connecting wire.</p>	<p>Note: The descriptions above, ①-⑧, are for EA, Eb and EC.</p>
EC (6846)	<p>Startup time over The unit cannot finish startup process within 4 minutes after power on.</p>	<p>① Contact failure of indoor/outdoor unit connecting wire</p> <p>② Diameter or length of indoor/outdoor unit connecting wire is out of specified capacity.</p> <p>⑦ 2 or more outdoor units have refrigerant address "0" . (In case of group control)</p> <p>⑧ Noise has entered into power supply or indoor/outdoor unit connecting wire.</p>	

<Abnormalities detected while unit is operating>

Check Code	Abnormal point and detection method	Case	Judgment and action
U1 (1302)	<p>High pressure (High pressure switch 63H operated) Abnormal if high pressure switch 63H operated (4.15 MPa) during compressor operation. 63H: High pressure switch</p>	<p>① Short cycle of indoor unit ② Clogged filter of indoor unit ③ Decreased airflow caused by dirt of indoor fan ④ Dirt of indoor heat exchanger ⑤ Locked indoor fan motor ⑥ Malfunction of indoor fan motor ⑦ Defective operation of stop valve (Not full open) ⑧ Clogged or broken pipe ⑨ Locked outdoor fan motor ⑩ Malfunction of outdoor fan motor ⑪ Short cycle of outdoor unit ⑫ Dirt of outdoor heat exchanger ⑬ Decreased airflow caused by defective inspection of outside temperature thermistor (It detects lower temperature than actual temperature.) ⑭ Disconnection or contact failure of connector (63H) on outdoor controller board ⑮ Disconnection or contact failure of 63H connection ⑯ Defective outdoor controller board ⑰ Defective action of linear expansion valve ⑱ Malfunction of fan driving circuit</p>	<p>①-⑥ Check indoor unit and repair defect. ⑦ Check if stop valve is fully open. ⑧ Check piping and repair defect. ⑨-⑫ Check outdoor unit and repair defect. ⑬ Check the detected temperature of outside temperature thermistor on LED display. (SW2 on A-Control Service Tool : Refer to "10-10. FUNCTION OF SWITCHES, CONNECTORS AND JUMPERS".) ⑭-⑯ Turn the power off and check F5 is displayed when the power is turned again. When F5 is displayed, refer to "Judgment and action" for F5. ⑰ Check linear expansion valve. Refer to "10-6. HOW TO CHECK THE PARTS". ⑱ Replace outdoor controller board.</p>
U2 (1102)	<p>High discharge temperature (1) Abnormal if TH4 exceeds 125°C or 110°C continuously for 5 minutes. Abnormal if TH4 exceeds 110°C (115 °C for R3/R4/R5 models) or more continuously for 30 seconds after 90 seconds have passed since the defrosting operation started. (2) Abnormal if discharge superheat (Cooling: TH4-T_{63HS} / Heating: TH4-T_{63HS}) exceeds 70°C continuously for 10 minutes. TH4: Thermistor <Discharge></p> <p>High comp. surface temperature Abnormal if TH34 exceeds 125°C (175 °C for R3/R4/R5 models) . In the case of high comp. surface temperature error, compressor does not restart unless the thermistor (TH34) becomes less than 95°C . TH34: Thermistor <Comp. surface></p>	<p>① Overheated compressor operation caused by shortage of refrigerant ② Defective operation of stop valve ③ Defective thermistor ④ Defective outdoor controller board ⑤ Defective action of linear expansion valve ⑥ Clogging with foreign objects in refrigerant circuit * Clogging occur in the parts which become below freezing point when water enters in refrigerant circuit. ⑦ In the case of the unit does not restart: Detection temp. of thermistor (TH34) ≥ 95°C</p>	<p>① Check intake superheat. Check leakage of refrigerant. Charge additional refrigerant. ② Check if stop valve is fully open. ③④ Turn the power off and check if U3 is displayed when the power is turned on again. When U3 is displayed, refer to "Judgment and action" for U3. ⑤ Check linear expansion valve. Refer to "10-6. HOW TO CHECK THE PARTS". ⑥ After recovering refrigerant, remove water from entire refrigerant circuit under vacuum more than 1 hour.</p>
U3 (5104)	<p>Open/short circuit of outdoor unit temperature thermistor (TH4, TH34) Abnormal if open (3°C or less) or short (217°C or more) is detected during compressor operation. (Detection is inoperative for 10 minutes of compressor starting process and for 10 minutes after and during defrosting.) TH4: Thermistor <Discharge> TH34: Thermistor <Comp. surface></p>	<p>① Disconnection or contact failure of connectors (TH4, TH34) on the outdoor controller circuit board ② Defective thermistor ③ Defective outdoor controller circuit board</p>	<p>① Check connection of connector (TH4, TH34) on the outdoor controller circuit board. Check breaking of the lead wire for TH4, TH34. Refer to "10-9.TEST POINT DIAGRAM". ② Check resistance value of TH4, TH34 or temperature by microprocessor. (Thermistor/TH4, TH34: Refer to "10-6. HOW TO CHECK THE PARTS".) (SW2 on A-Control Service Tool: Refer to "10-10. FUNCTION OF SWITCHES, CONNECTORS AND JUMPERS".) ③ Replace outdoor controller board.</p>

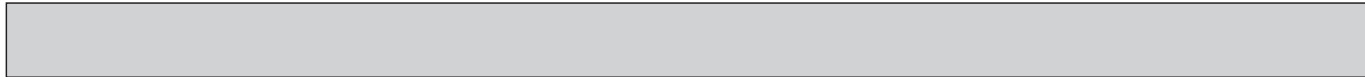

Check code	Abnormal point and detection method	Case	Judgment and action																									
U4 (TH3:5105) (TH6:5107) (TH7:5106) (TH8:5110) (TH32:5105) (TH33:5105)	Open/short of outdoor unit thermistors (TH3, TH32, TH33, TH6, TH7, and TH8) Abnormal if open or short is detected during compressor operation. Open detection of TH3, TH32, TH33 and TH6 is inoperative for 10 seconds to 10 minutes after compressor starting and 10 minutes after and during defrosting. Note: Check which unit has abnormality in its thermistor by switching the mode of SW2. (PAC-SK52ST) (Refer to "10-10. FUNCTION OF SWITCHES, CONNECTORS AND JUMPERS".)	① Disconnection or contact failure of connectors Outdoor controller circuit board: (TH3, TH32, TH33, TH7/6) Outdoor power circuit board: CN3 ② Defective thermistor ③ Defective outdoor controller circuit board	① Check connection of connector (TH3, TH32, TH33, TH7/6) on the outdoor controller circuit board. Check connection of connector (CN3) on the outdoor power circuit board. Check breaking of the lead wire for TH3, TH32, TH33, TH6, TH7, TH8. Refer to "10-9.TEST POINT DIAGRAM". ② Check resistance value of TH3, TH32, TH33, TH6,TH7,TH8 or check temperature by microprocessor. (TH3,TH6,TH7,TH8: Refer to "10-9.TEST POINT DIAGRAM".) (SW2 on A-Control Service Tool: Refer to "10-10. FUNCTION OF SWITCHES, CONNECTORS AND JUMPERS".) ③ Replace outdoor controller circuit board. Note: Emergency operation is available in case of abnormalities of TH3, TH32, TH33, TH6 and TH7. Refer to "10-8. EMERGENCY OPERATION".																									
					<table border="1"> <thead> <tr> <th colspan="2">Thermistors</th> <th>Open detection</th> <th>Short detection</th> </tr> <tr> <th>Symbol</th> <th>Name</th> <th></th> <th></th> </tr> </thead> <tbody> <tr> <td>TH3,TH32,TH33</td> <td>Thermistor <Liquid>, <Suction>, <Ref. check></td> <td>-40 °C or below</td> <td>90 °C or above</td> </tr> <tr> <td>TH6</td> <td>Thermistor <2-phase pipe></td> <td>-40 °C or below</td> <td>90 °C or above</td> </tr> <tr> <td>TH7</td> <td>Thermistor <Ambient></td> <td>-40 °C or below</td> <td>90 °C or above</td> </tr> <tr> <td>TH8</td> <td>Thermistor <Heat sink> SHW112, 140Y</td> <td>-35 °C or below</td> <td>102 °C or above</td> </tr> <tr> <td>TH8</td> <td>Internal thermistor SHW80, 112V</td> <td>-35 °C or below</td> <td>170 °C or above</td> </tr> </tbody> </table>	Thermistors		Open detection	Short detection	Symbol	Name			TH3,TH32,TH33	Thermistor <Liquid>, <Suction>, <Ref. check>	-40 °C or below	90 °C or above	TH6	Thermistor <2-phase pipe>	-40 °C or below	90 °C or above	TH7	Thermistor <Ambient>	-40 °C or below	90 °C or above	TH8	Thermistor <Heat sink> SHW112, 140Y	-35 °C or below
Thermistors		Open detection	Short detection																									
Symbol	Name																											
TH3,TH32,TH33	Thermistor <Liquid>, <Suction>, <Ref. check>	-40 °C or below	90 °C or above																									
TH6	Thermistor <2-phase pipe>	-40 °C or below	90 °C or above																									
TH7	Thermistor <Ambient>	-40 °C or below	90 °C or above																									
TH8	Thermistor <Heat sink> SHW112, 140Y	-35 °C or below	102 °C or above																									
TH8	Internal thermistor SHW80, 112V	-35 °C or below	170 °C or above																									
U5 (4230)	Temperature of heat sink Abnormal if TH8 detects temperature indicated below. SHW80V95°C SHW112V95°C SHW112Y84°C SHW140Y84°C TH8: Internal thermistor (80/112V) TH8: Thermistor <Heat sink> (112/140Y)	① The outdoor fan motor is locked. ② Failure of outdoor fan motor ③ Air flow path is clogged. ④ Rise of ambient temperature ⑤ Defective thermistor ⑥ Defective input circuit of outdoor power circuit board ⑦ Failure of outdoor fan drive circuit	①② Check outdoor fan. ③ Check air flow path for cooling. ④ Check if there is something which causes temperature rise around outdoor unit. (Upper limit of ambient temperature is 46°C.) Turn off power, and on again to check if U5 is displayed within 30 minutes. If U4 is displayed instead of U5, follow the action to be taken for U4. ⑤ Check resistance value of TH8 or temperature by microprocessor. (TH8: Refer to "10-6. HOW TO CHECK THE PARTS".) (SW2 on A-Control Service Tool: Refer to "10-10. FUNCTION OF SWITCHES, CONNECTORS AND JUMPERS".) ⑥ Replace outdoor power circuit board. ⑦ Replace outdoor controller circuit board.																									
U6 (4250)	Power module Check abnormality by driving power module in case overcurrent is detected. (UF or UP error condition)	① Outdoor stop valve is closed. ② Decrease of power supply voltage ③ Looseness, disconnection or converse of compressor wiring connection ④ Defective compressor ⑤ Defective outdoor power circuit board	① Open stop valve. ② Check facility of power supply. ③ Correct the wiring (U-V-W phase) to compressor. Refer to "10-9.TEST POINT DIAGRAM" (Outdoor power circuit board). ④ Check compressor referring to "10-6. HOW TO CHECK THE PARTS". ⑤ Replace outdoor power circuit board.																									
U7 (1520)	Too low superheat due to low discharge temperature Abnormal if discharge superheat is continuously detected less than or equal to -15°C for 3 minutes even though linear expansion valve has minimum open pulse after compressor starts operating for 10 minutes.	① Disconnection or loose connection of discharge temperature thermistor (TH4) ② Defective holder of discharge temperature thermistor ③ Disconnection or loose connection of linear expansion valve's coil ④ Disconnection or loose connection of linear expansion valve's connector ⑤ Defective linear expansion valve	①② Check the installation conditions of discharge temperature thermistor (TH4). ③ Check the coil of linear expansion valve. Refer to "10-7. HOW TO CHECK THE COMPONENTS". ④ Check the connection or contact of LEV-A and LEV-B on outdoor controller circuit board. ⑤ Check linear expansion valve. Refer to "10-6. HOW TO CHECK THE PARTS".																									
U8 (4400)	Outdoor fan motor Abnormal if rotational frequency of the fan motor is not detected during DC fan motor operation. Fan motor rotational frequency is abnormal if; • 100 rpm or below detected continuously for 15 seconds at 20°C or more outside air temperature. • 50 rpm or below or 1500 rpm or more detected continuously for 1 minute.	① Failure in the operation of the DC fan motor ② Failure in the outdoor circuit controller board	① Check or replace the DC fan motor. ② Check the voltage of the outdoor circuit controller board during operation. ③ Replace the outdoor circuit controller board. (When the failure is still indicated even after performing the action ① above.)																									

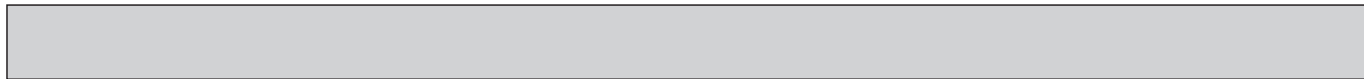

Check code	Abnormal point and detection method	Case	Judgment and action	
U9 (4220)	Detailed codes	To find out the details about U9 error, turn ON SW2-1, 2-2, 2-3, 2-4, 2-5 and 2-6 when U9 error occurs. To find out the detail history (latest) about U9 error, turn ON SW2-1, 2-2 and 2-6. Refer to "10-10. FUNCTION OF SWITCHES, CONNECTORS AND JUMPERS".		
	01	Overvoltage error • Increase in DC bus voltage to SHW80, 112VHA: 400V SHW112, 140YHA: 760V	① Abnormal increase in power source voltage ② Disconnection of compressor wiring ③ Defective outdoor power circuit board ④ Compressor has a ground fault.	① Check the field facility for the power supply. ② Correct the wiring (U·V·W phase) to compressor. Refer to "10-10. FUNCTION OF SWITCHES, CONNECTORS AND JUMPERS". (Outdoor power circuit board). ③ Replace outdoor power circuit board. ④ Check compressor for electrical insulation. Replace compressor.
	02	Undervoltage error • Instantaneous decrease in DC bus voltage to SHW80, 112VHA: 200V SHW112, 140YHA: 350V	① Decrease in power source voltage, instantaneous stop ② Disconnection or loose connection of CN52C on the outdoor power circuit board/controller circuit board (SHW·VHA) ③ Defective converter drive circuit in outdoor power circuit board (SHW·VHA) ④ Defective 52C drive circuit in outdoor power circuit board ⑤ Defective outdoor converter circuit board (SHW·YHA) ⑥ Disconnection or loose connection of rush current protect resistor RS (SHW·YHA) ⑦ Defective rush current protect resistor RS (SHW·YHA) ⑧ Disconnection or loose connection of main smoothing capacitor CB (SHW·VHA) ⑨ Disconnection or loose connection of CN2 on the outdoor power circuit board /controller circuit board (SHW·VHA) ⑩ Power circuit failure on DC supply for 18 V DC output on outdoor controller circuit board (SHW·VHA)	① Check the field facility for the power supply. ② Check CN52C wiring. (SHW·VHA) ③ Replace outdoor power circuit board. (SHW·VHA) ④ Replace outdoor power circuit board. ⑤ Replace outdoor converter circuit board. (SHW·YHA) ⑥ Check RS wiring. (SHW·YHA) ⑦ Replace RS. (SHW·YHA) ⑧ Check CB wiring. (SHW·VHA) ⑨ Check CN2 wiring. (SHW·VHA) ⑩ Replace outdoor controller circuit board. (SHW·VHA)
	04	Input current sensor error/ L1-phase open error • Decrease in input current through outdoor unit to 0.1A only if operation frequency is more than or equal to 40Hz or compressor current is more than or equal to 6A.	① L1-phase open (SHW·YHA) ② Disconnection or loose connection between TB1 and outdoor noise filter circuit board (SHW·YHA) ③ Disconnection or loose connection of CN5 on the outdoor power circuit board/CNCT on the outdoor noise filter board ④ Defective ACCT (AC current trans) on the outdoor noise filter circuit board (SHW·YHA) ⑤ Defective input current detection circuit in outdoor power circuit board ⑥ Defective outdoor controller circuit board	① Check the field facility for the power supply. (SHW·YHA) ② Check the wiring between TB1 and outdoor noise filter circuit board. (SHW·YHA) ③ Check CN5/CNCT wiring. (SHW·YHA) ④ Replace outdoor noise filter circuit board. (SHW·YHA) ⑤ Replace outdoor power circuit board. ⑥ Replace outdoor controller circuit board.
08	Abnormal power synchronous signal • No input of power synchronous signal to power circuit board • Power synchronous signal of 44 Hz or less, or 65 Hz or more is detected on power circuit board.	① Distortion of power source voltage, noise superimposition. ② Disconnection or loose connection of earth wiring ③ Disconnection or loose connection of CN2 on the outdoor power circuit board /controller circuit board ④ Defective power synchronous signal circuit in outdoor controller circuit board ⑤ Defective power synchronous signal circuit in outdoor power circuit board	① Check the field facility for the power supply. ② Check earth wiring. ③ Check CN2 wiring. ④ Replace outdoor controller circuit board. ⑤ Replace outdoor power circuit board.	

Continue to the next page

From the previous page.

Check code	Abnormal point and detection method	Case	Judgment and action	
U9 (4220)	Detailed codes	Not applicable for SHW80, 112VHA and SHW112, 140YHA models.	Check for the switch settings for Model Select on the outdoor controller circuit board.	
	10			PFC error (Overvoltage/Undervoltage/Overcurrent) <ul style="list-style-type: none"> PFC detected any of the following <ol style="list-style-type: none"> Increase of DC bus voltage to 420 V. Decrease in PFC control voltage to 12 V DC or lower Increase in input current to 50A peak (For models equipped with single-phase PFC only)
	20	PFC/IGBT error (Undervoltage) <ul style="list-style-type: none"> When Compressor is running, DC bus voltage stays at 310 V or lower for consecutive 10 seconds (SHW80, 112VHA only) 	<ol style="list-style-type: none"> Incorrect switch settings on the outdoor controller circuit board for model select Defective outdoor power circuit board Defective outdoor controller circuit board 	<ol style="list-style-type: none"> Correction of a model select Replace outdoor power circuit board. Replace outdoor controller circuit board.
Ud (1504)	Overheat protection Abnormal if TH3, condensing temperature T _{63HS} detects 70°C or more during compressor operation. TH3: Thermistor <Liquid>	<ol style="list-style-type: none"> Defective outdoor fan (fan motor) or short cycle of outdoor unit during cooling operation Defective TH3, condensing temperature T_{63HS} Defective outdoor controller board 	<ol style="list-style-type: none"> Check outdoor unit air passage. Turn the power off and on again to check the check code. If U4 is displayed, follow the U4 processing direction. 	
UE (1302)	Abnormal pressure of 63HS Abnormal if 63HS detects 0.1 MPa or less. Detection is inoperative for 3 minutes after compressor starting and 3 minutes after and during defrosting. 63HS: High pressure sensor	<ol style="list-style-type: none"> Disconnection or contact failure of connector (63HS) on the outdoor controller circuit board Defective pressure sensor Defective outdoor controller circuit board 	<ol style="list-style-type: none"> Check connection of connector (63HS) on the outdoor controller circuit board. Check breaking of the lead wire for 63HS. Check pressure by microprocessor. (Pressure sensor/ 63HS) (SW2: Refer to "10-10. FUNCTION OF SWITCHES, CONNECTORS AND JUMPERS".) Replace outdoor controller board. 	
UF (4100)	Compressor overcurrent interruption (When compressor locked) Abnormal if overcurrent of DC bus or compressor is detected within 30 seconds after compressor starts operating.	<ol style="list-style-type: none"> Stop valve is closed. Decrease of power supply voltage Looseness, disconnection or converse of compressor wiring connection Defective compressor Defective outdoor power board 	<ol style="list-style-type: none"> Open stop valve. Check facility of power supply. Correct the wiring (U·V·W phase) to compressor. Refer to "10-9.TEST POINT DIAGRAM". (Outdoor power circuit board). Check compressor. Refer to "10-6. HOW TO CHECK THE PARTS". Replace outdoor power circuit board. 	
UH (5300)	Current sensor error or input current error <ul style="list-style-type: none"> Abnormal if current sensor detects -1.0A to 1.0A during compressor operation. (This error is ignored in case of test run mode.) Abnormal if 40A (SHW80,112V) of input current is detected or 37A (SHW80,112V) or more of input current is detected for 10 seconds continuously. 	<ol style="list-style-type: none"> Disconnection of compressor wiring Defective circuit of current sensor on outdoor power circuit board Decrease of power supply voltage Leakage or shortage of refrigerant 	<ol style="list-style-type: none"> Correct the wiring (U·V·W phase) to compressor. Refer to "10-9.TEST POINT DIAGRAM" (Outdoor power circuit board). Replace outdoor power circuit board. Check the facility of power supply. Check leakage of refrigerant. 	
UL (1300)	Low pressure (63L operated) Abnormal if 63L is operated (under -0.03MPa) during compressor operation. 63L: Low pressure switch	<ol style="list-style-type: none"> Stop valve of outdoor unit is closed during operation. Disconnection or loose connection of connector (63L) on outdoor controller board Disconnection or loose connection of 63L Defective outdoor controller board Leakage or shortage of refrigerant Malfuction of linear expansion valve 	<ol style="list-style-type: none"> Check stop valve. Turn the power off and on again to check if F3 is displayed on restarting. If F3 is displayed, follow the F3 processing direction. Correct to proper amount of refrigerant. Check linear expansion valve. Refer to "10-6. HOW TO CHECK THE PARTS". 	

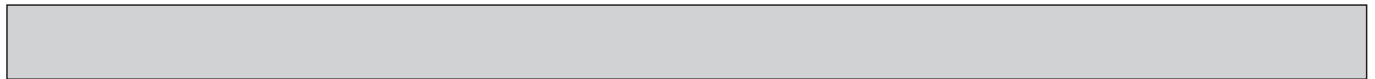

Check code	Abnormal point and detection method	Case	Judgment and action
UP (4210)	Compressor overcurrent interruption Abnormal if overcurrent DC bus or compressor is detected after compressor starts operating for 30 seconds.	① Stop valve of outdoor unit is closed. ② Decrease of power supply voltage ③ Looseness, disconnection or converse of compressor wiring connection ④ Defective fan of indoor/outdoor units ⑤ Short cycle of indoor/outdoor units ⑥ Defective input circuit of outdoor controller board ⑦ Defective compressor ⑧ Defective outdoor power circuit board ⑨ DIP switch setting difference of outdoor controller circuit board	① Open stop valve. ② Check facility of power supply. ③ Correct the wiring (U-V-W phase) to compressor. Refer to "10-9.TEST POINT DIAGRAM" (Outdoor power circuit board). ④ Check indoor/outdoor fan. ⑤ Solve short cycle. ⑥ Replace outdoor controller circuit board. Note: Before the replacement of the outdoor controller circuit board, disconnect the wiring to compressor from the outdoor power circuit board and check the output voltage among phases, U, V, W, during test run. No defect on board if voltage among phases (U-V, V-W and W-U) is same. Make sure to perform the voltage check with same performing frequency. ⑦ Check compressor. Refer to "10-6. HOW TO CHECK THE PARTS". ⑧ Replace outdoor power circuit board. ⑨ Check the DIP switch setting of outdoor controller circuit board.
E0 or E4 (6831 or 6834)	Remote controller transmission error (E0)/ signal receiving error (E4) ① Abnormal if main or sub remote controller cannot receive normally any transmission from indoor unit of refrigerant address "0" for 3 minutes. (Check code : E0) ② Abnormal if sub remote controller could not receive any signal for 2 minutes. (Check code: E0) ③ Abnormal if indoor controller board cannot receive normally any data from remote controller board or from other indoor controller board for 3 minutes. (Check code: E4) ④ Indoor controller board cannot receive any signal from remote controller for 2 minutes. (Check code: E4)	① Contact failure at transmission wire of remote controller ② All remote controllers are set as "sub" remote controller. In this case, E0 is displayed on remote controller, and E4 is displayed at LED (LED1, LED2) on the outdoor controller circuit board. ③ Miswiring of remote controller ④ Defective transmitting receiving circuit of remote controller ⑤ Defective transmitting receiving circuit of indoor controller board of refrigerant address "0" ⑥ Noise has entered into the transmission wire of remote controller.	① Check disconnection or looseness of indoor unit or transmission wire of remote controller. ② Set one of the remote controllers "main" if there is no problem with the action above. ③ Check wiring of remote controller. • Total wiring length: Max. 500 m (Do not use cable × 3 or more.) • The number of connecting indoor units: Max. 16 units • The number of connecting remote controller: Max. 2 units If the cause of trouble is not in above ①-③, ④ Diagnose remote controllers. a) When "RC OK" is displayed, Remote controllers have no problem. Turn the power off, and on again to check. If abnormality generates again, replace indoor controller board. b) When "RC NG" is displayed, Replace remote controller. c) When "RCE3" or "ERC00-66" is displayed, noise may be causing abnormality. Note: If the unit is not normal after replacing indoor controller board in group control, indoor controller board of address "0" may be abnormal.
E1 or E2 (6201 or 6202)	Remote controller control board ① Abnormal if data cannot be normally read from the nonvolatile memory of the remote controller control board. (Check code: E1) ② Abnormal if the clock function of remote controller cannot be normally operated. (Check code: E2)	Defective remote controller	Replace remote controller.



Check code	Abnormal point and detection method	Case	Judgment and action
E3 or E5 (6832 or 6833)	<p>Remote controller transmission error (E3)/ signal receiving error (E5)</p> <p>① Abnormal if remote controller could not find blank of transmission path for 6 seconds and could not transmit. (Check code: E3)</p> <p>② Remote controller receives transmitted data at the same time, compares the data, and when detecting it, judges different data to be abnormal 30 continuous times. (Check code: E3)</p> <p>① Abnormal if indoor controller board could not find blank of transmission path. (Check code: E5)</p> <p>② Indoor controller board receives transmitted data at the same time, compares the data, and when detecting it, judges different data to be abnormal 30 continuous times. (Check code: E5)</p>	<p>① 2 remote controllers are set as "main." (In case of 2 remote controllers)</p> <p>② Remote controller is connected with 2 indoor units or more.</p> <p>③ Repetition of refrigerant address</p> <p>④ Defective transmitting receiving circuit of remote controller</p> <p>⑤ Defective transmitting receiving circuit of indoor controller board</p> <p>⑥ Noise has entered into transmission wire of remote controller.</p>	<p>① Set a remote controller to main, and the other to sub.</p> <p>② Remote controller is connected with only one indoor unit.</p> <p>③ The address changes to a separate setting.</p> <p>④–⑥ Diagnose remote controller.</p> <p>a) When "RC OK" is displayed, remote controllers have no problem. Turn the power off, and on again to check. When becoming abnormal again, replace indoor controller board.</p> <p>b) When "RC NG" is displayed, replace remote controller.</p> <p>c) When "RC E3" or "ERC 00-66" is displayed, noise may be causing abnormality.</p>
E8 (6840)	<p>Indoor/outdoor unit communication error (Signal receiving error) (Outdoor unit)</p> <p>Abnormal if outdoor controller circuit board could not receive anything normally for 3 minutes.</p>	<p>① Contact failure of indoor/outdoor unit connecting wire</p> <p>② Defective communication circuit of outdoor controller circuit board</p> <p>③ Defective communication circuit of indoor controller board</p> <p>④ Noise has entered into indoor/outdoor unit connecting wire.</p>	<p>① Check disconnection or looseness of indoor/outdoor unit connecting wire of indoor or outdoor units.</p> <p>②–④ Turn the power off, and on again to check. Replace indoor controller board or outdoor controller circuit board if abnormality is displayed again.</p>
E9 (6841)	<p>Indoor/outdoor unit communication error (Transmitting error) (Outdoor unit)</p> <p>① Abnormal if "0" receiving is detected 30 times continuously though outdoor controller circuit board has transmitted "1".</p> <p>② Abnormal if outdoor controller circuit board could not find blank of transmission path for 3 minutes.</p>	<p>① Indoor/ outdoor unit connecting wire has contact failure.</p> <p>② Defective communication circuit of outdoor controller circuit board</p> <p>③ Noise has entered power supply.</p> <p>④ Noise has entered indoor/outdoor unit connecting wire.</p>	<p>① Check disconnection or looseness of indoor/outdoor unit connecting wire.</p> <p>②–④ Turn the power off, and on again to check. Replace outdoor controller circuit board if abnormality is displayed again.</p>
EF (6607 or 6608)	<p>Non defined check code</p> <p>This code is displayed when non defined check code is received.</p>	<p>① Noise has entered transmission wire of remote controller.</p> <p>② Noise has entered indoor/outdoor unit connecting wire.</p> <p>③ Outdoor unit is not inverter models.</p>	<p>①② Turn the power off, and on again to check. Replace indoor controller board or outdoor controller circuit board if abnormality is displayed again.</p> <p>③ Replace outdoor unit with inverter type outdoor unit.</p>
Ed (0403)	<p>Serial communication error</p> <p>① Abnormal if serial communication between outdoor controller circuit board and outdoor power circuit board is defective.</p> <p>② Abnormal if communication between outdoor controller circuit board and M-NET board is not available.</p>	<p>① Breaking of wire or contact failure of connector CN2 between the outdoor controller circuit board and the outdoor power circuit board</p> <p>② Breaking of wire or contact failure of connector CN4 between the outdoor controller circuit board and the outdoor power circuit board</p> <p>③ Defective communication circuit of outdoor power circuit board</p> <p>④ Defective communication circuit of outdoor controller circuit board for outdoor power circuit board</p> <p>① Breaking of wire or contact failure of connector between outdoor controller circuit board and M-NET board</p> <p>② Contact failure of M-NET board power supply line</p> <p>③ Noise has entered into M-NET transmission wire.</p>	<p>①② Check connection of each connector CN2 and CN4 between the outdoor controller circuit board and the outdoor power circuit board.</p> <p>③ Replace outdoor power circuit board.</p> <p>④ Replace outdoor controller circuit board.</p> <p>① Check disconnection, looseness, or breaking of connection wire between outdoor controller circuit board (CNMNT) and M-NET board (CN5).</p> <p>② Check disconnection, looseness, or breaking of connection wire between outdoor controller circuit board (CNMNT) and M-NET board (CND).</p> <p>③ Check M-NET transmission wiring method.</p>

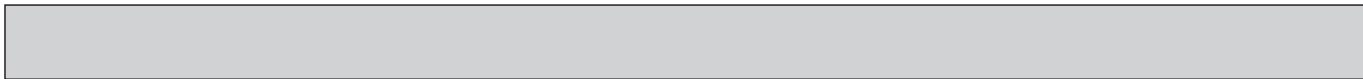

Check code	Abnormal point and detection method	Case	Judgment and action																		
P6	<p>Freezing/overheating protection is working Overheating protection <Heating mode> Abnormal if condensing temperature of 63HS detects Tcond. °C or more and compressor operation frequency is less than or equal to 25 Hz. Detection is inoperative during defrosting.</p> <p>63HS: High pressure sensor</p>	<p>① Overcharge of refrigerant ② Defective refrigerant circuit (clogs) ③ Malfunction of linear expansion valve ④ Reduced water flow · Clogged filter · Leakage of water ⑤ High temperature · Over-load · Inlet water is too warm. ⑥ Defective water pump Note: ④-⑥ is in the case that the unit is used as Air to water.</p>	<p>①② Check operating condition of refrigerant circuit. ③ Check linear expansion valve. ④⑤ Check water piping. ⑥ Check water pump.</p>																		
	<p>Tcond</p> <table border="1"> <thead> <tr> <th></th> <th>stage-a</th> <th>stage-b</th> <th>stage-c</th> <th>stage-d</th> <th>stage-e</th> <th>stage-f</th> <th>stage-g</th> <th>stage-s</th> </tr> </thead> <tbody> <tr> <td>Tcond</td> <td>63</td> <td>62</td> <td>61</td> <td>60</td> <td>59</td> <td>57</td> <td>51</td> <td>61</td> </tr> </tbody> </table>		stage-a	stage-b	stage-c	stage-d	stage-e	stage-f	stage-g	stage-s	Tcond	63	62	61	60	59	57	51	61		
	stage-a	stage-b	stage-c	stage-d	stage-e	stage-f	stage-g	stage-s													
Tcond	63	62	61	60	59	57	51	61													
P8	<p>Pipe temperature <Cooling mode> Detected as abnormal when the pipe temperature is not in the cooling range 3 minutes after compressor start and 6 minutes after the liquid or condenser/evaporator pipe is out of cooling range. Note 1: It takes at least 9 minutes to detect. Note 2: Abnormality P8 is not detected in drying mode. Cooling range: Indoor pipe temperature (TH2 or TH5) - room temperature (TH1) ≤ -3 °C TH: Lower temperature between liquid pipe temperature and condenser/evaporator temperature</p> <p><Heating mode> When 10 seconds have passed after the compressor starts operation and the hot adjustment mode has finished, the unit is detected as abnormal when condenser/evaporator pipe temperature is not in heating range within 20 minutes.</p> <p>Note 3: It takes at least 27 minutes to detect abnormality. Note 4: It excludes the period of defrosting (Detection restarts when defrosting mode is over) Heating range : 3°C ≤ (Condenser/ Evaporator temperature(TH5)- room temperature(TH1))</p>	<p>① Slight temperature difference between indoor room temperature and pipe <liquid or condenser/evaporator> temperature thermistor · Shortage of refrigerant · Disconnected holder of pipe <liquid or condenser/evaporator> thermistor · Defective refrigerant circuit ② Converse connection of extension pipe (on plural units connection) ③ Converse wiring of indoor/outdoor unit connecting wire (on plural units connection) ④ Defective detection of indoor room temperature and pipe <condenser/evaporator> temperature thermistor ⑤ Stop valve is not opened completely.</p>	<p>①-④ Check pipe <liquid or condenser/evaporator> temperature with room temperature display on remote controller and outdoor controller circuit board. Pipe <liquid or condenser/ evaporator> temperature display is indicated by setting SW2 of outdoor controller circuit board as follows.</p> <p>(Conduct temperature check with outdoor controller circuit board after connecting 'A-Control Service Tool (PAC-SK52ST)').</p> <p>②③ Check converse connection of extension pipe or converse wiring of indoor/outdoor unit connecting wire.</p>																		
PL	<p>Abnormal refrigerant circuit During Cooling, Dry, or Auto Cooling operation, the following conditions are regarded as failures when detected for 1 second. a)The compressor continues to run for 30 or more seconds. b)The liquid pipe temperature or the condenser/evaporator temperature is 75°C or more. <u>These detected errors will not be cancelled until the power source is reset.</u></p>	<p>① Abnormal operation of 4-way valve ② Disconnection of or leakage in refrigerant pipes ③ Air into refrigerant piping ④ Abnormal operation (no rotation) of indoor fan · Defective fan motor · Defective indoor control board. ⑤ Defective refrigerant circuit (clogging)</p>	<p>① <u>When this error occurs, be sure to replace the 4-way valve.</u> ② Check refrigerant pipes for disconnection or leakage. ③ After the recovery of refrigerant, vacuum dry the whole refrigerant circuit. ④ Refer to "10-6. HOW TO CHECK THE PARTS". ⑤ Check refrigerant circuit for operation. <u>To avoid entry of moisture or air into refrigerant circuit which could cause abnormal high pressure, purge air in refrigerant circuit or replace refrigerant.</u></p>																		

<M-NET communication error>

Note: "Indoor unit" in the text indicates M-NET board in outdoor unit.

Check code	Abnormal point and detection method	Case	Judgment and action
A0 (6600)	Address duplicate definition This error is displayed when transmission from the units of same address is detected. Note: The address and attribute displayed at remote controller indicate the controller that detected abnormality.	① There are 2 or more same address of controller of outdoor unit, indoor unit, FRESH MASTER, or LOSSNAY. ② Noise has entered into transmission signal and signal was transformed.	Search the unit with same address as abnormality occurred. If the same address is found, turn off the power supply of outdoor unit and indoor unit and FRESH MASTER or LOSSNAY at the same time for 2 minutes or more after the address is corrected, and turn the power on again. Check transmission waveform or noise on transmission wire.
A2 (6602)	Hard ware error of transmission processor Transmission processor intended to transmit "0", but "1" appeared on transmission wire. Note: The address and attribute display at remote controller indicate the controller that detected abnormality.	① Error is detected if waveform is transformed when wiring works of transmission wire of outdoor unit, indoor unit, FRESH MASTER or LOSSNAY are done, or polarity is changed with the power on and transmission data collides each other. ② Defective transmitting receiving circuit of transmission processor ③ Transmission data is changed by the noise on transmission.	① If the works of transmission wire is done with the power on, turn off the power supply of outdoor unit and indoor unit and FRESH MASTER or LOSSNAY at the same time for 2 minutes or more, and turn the power on again. ② Check transmission waveform or noise on transmission wire.
A3 (6603)	BUS BUSY 1. Overtime error by signal collision damage Abnormal if transmitting signal is not possible for 8-10 minutes continuously because of collision of transmission. 2. Data could not reach transmission wire for 8-10 minutes continuously because of noise or, etc. Note: The address and attribute displayed at remote controller indicate the controller that detected abnormality.	① Transmission processor could not transmit signal because short cycle voltage of noise and the like have entered into transmission wire continuously. ② Transmission quantity has increased and transmission of signal is not possible because there was wiring mistake of terminal block for transmission wire (TB3) and terminal block for central control (TB7) in outdoor unit. ③ Transmission are mixed with others and occupation rate on transmission wire rose because of defective repeater (a function to connector or disconnect transmission of control and central control system) of outdoor unit, then abnormality is detected.	① Check if transmission wire of indoor unit, FRESH MASTER, LOSSNAY, or remote controller is not connected to terminal block for central control (TB7) of outdoor unit. ② Check if transmission wire of indoor unit, FRESH MASTER or LOSSNAY is not connected to terminal block for transmission wire of outdoor unit. ③ Check if terminal block for transmission wire (TB3) and terminal block for central control (TB7) is not connected. ④ Check transmission waveform or noise on transmission wire.
A6 (6606)	Communication error with communication processor Defective communication between unit processor and transmission processor Note: The address and attribute display at remote controller indicate the controller that detected abnormality.	① Data of transmission processor or unit processor is not transmitted normally because of accidental trouble such as noise or thunder surge. ② Address forwarding from unit processor is not transmitted normally because of defective transmission processor hardware.	Turn off the power supply of outdoor unit, indoor unit and FRESH MASTER or LOSSNAY at the same time for 2 minutes or more, and turn the power on again. System returns normally if abnormality was accidental malfunction. If the same abnormality generates again, abnormality-generated controller may be defective.

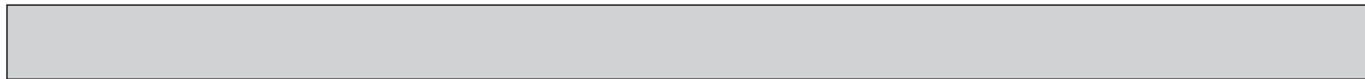

Check code	Abnormal point and detection method	Case	Judgment and action
<p style="text-align: center;">A7 (6607)</p>	<p>NO ACK signal</p> <p>1. Transmitting side controller detects abnormal if a message was transmitted but there is no reply (ACK) that a message was received. Transmitting side detects abnormality every 30 seconds, 6 times continuously.</p> <p>Note: The address and attribute displayed at remote controller indicate the controller that did not reply (ACK).</p>	<p>Common factor that has no relation with abnormality source</p> <p>① The unit of former address does not exist as address switch has changed while the unit was energized.</p> <p>② Extinction of transmission wire voltage and signal is caused by over-range transmission wire.</p> <ul style="list-style-type: none"> • Maximum distance……200 m • Remote controller line (12 m) <p>③ Extinction of transmission wire voltage and signal is caused by type-unmatched transmission wire.</p> <p>Type……</p> <ul style="list-style-type: none"> With shield wire- CVVS, CPEVS With normal wire (no shield)- VCTF, VCTFK, CVV CVS, VVR, VVF, VCT <p>Diameter……1.25 mm² or more</p> <p>④ Extinction of transmission wire voltage and signal is caused by over-numbered units.</p> <p>⑤ Accidental malfunction of abnormality-detected controller (noise, thunder surge)</p> <p>⑥ Defective of abnormality-generated controller</p>	<p>Always try the followings when the error “A7” occurs.</p> <p>① Turn off the power supply of outdoor unit, indoor unit and FRESH MASTER or LOSSNAY at the same time for 2 minutes or more, and turn the power on again. If malfunction was accidental, the unit returns to normal.</p> <p>② Check address switch of abnormality-generated address.</p> <p>③ Check disconnection or looseness of abnormality-generated or abnormality-detected transmission wire (terminal block and connector)</p> <p>④ Check if tolerance range of transmission wire is not exceeded.</p> <p>⑤ Check if type of transmission wire is correct or not.</p> <p>If the cause of trouble is in ①–⑤ above, repair the defect, then turn off the power supply of outdoor unit, indoor unit and FRESH MASTER or LOSSNAY at the same time for 2 minutes or more, and turn the power on again.</p> <ul style="list-style-type: none"> • If the cause of trouble is not in ①–⑤ above in single refrigerant system (1 outdoor unit), controller of displayed address or attribute is defective. • If the cause of trouble is not in ①–⑤ above in different refrigerant system (2 or more outdoor units), judge with ⑥. <p>⑥ If address of abnormality source is the address that should not exist, there is the unit that memorizes nonexistent address information. Delete useless address information with manual setting function of remote controller.</p> <p>Only the system FRESH MASTER or LOSSNAY are connected to, or the system that is equipped with group setting of different refrigerant system.</p>
	<p>2. If displayed address or attribute is outdoor unit, indoor unit detects abnormality when indoor unit transmits signal to outdoor unit and there was no reply (ACK).</p>	<p>① Contact failure of transmission wire of outdoor unit or indoor unit</p> <p>② Disconnection of transmission connector (CN2M) of outdoor unit</p> <p>③ Defective transmitting receiving circuit of outdoor unit or indoor unit</p>	<p>If the cause of trouble is not any of ①–⑥ above, replace the controller board of displayed address or attribute.</p> <p>If the unit does not return normally, multi controller board of outdoor unit may be defective (repeater circuit). Replace multi-controller board one by one to check if the unit returns normally.</p>
	<p>3. If displayed address or attribute is indoor unit, remote controller detects abnormality when remote controller transmits signal to indoor unit and there was no reply (ACK).</p>	<p>① During group operation with indoor unit of multi-refrigerant system, if remote controller transmits signal to indoor unit while outdoor unit power supply of one refrigerant system is turned off or within 2 minutes of restart, abnormality is detected.</p> <p>② Contact failure of transmission wire of remote controller or indoor unit</p> <p>③ Disconnection of transmission connector (CN2M) of indoor unit</p> <p>④ Defective transmitting receiving circuit of indoor unit or remote controller</p>	<p>If the cause of trouble is not any of ①–⑥ above, replace the controller board of displayed address or attribute.</p> <p>If the unit does not return normally, multi controller board of outdoor unit may be defective (repeater circuit). Replace multi-controller board one by one to check if the unit returns normally.</p>

From the previous page.

Check code	Abnormal point and detection method	Case	Judgment and action
A7 (6607)	4. If displayed address or attribute is remote controller, indoor unit detects abnormality when indoor unit transmits signal to remote controller and there was no reply (ACK).	① During group operation with indoor unit of multi-refrigerant system, if indoor unit transmit signal to remote controller while outdoor unit power supply of one refrigerant system is turned off or within 2 minutes of restart, abnormality is detected. ② Contact failure of transmission wire of remote controller or indoor unit ③ Disconnection of transmission connector (CN2M) of indoor unit ④ Defective transmitting receiving circuit of indoor unit or remote controller	Same as mentioned in "A7" of the previous page.
	5. If displayed address or attribute is FRESH MASTER, indoor unit detects abnormality when indoor unit transmits signal to FRESH MASTER and there was no reply (ACK).	① During sequential operation of indoor unit and FRESH MASTER of other refrigerant system, if indoor unit transmits signal to FRESH MASTER while outdoor unit power supply of same refrigerant system with FRESH MASTER is turned off or within 2 minutes of restart, abnormality is detected. ② Contact failure of transmission wire of indoor unit or FRESH MASTER ③ Disconnection of transmission connector (CN2M) of indoor unit or FRESH MASTER ④ Defective transmitting receiving circuit of indoor unit or FRESH MASTER	
	6. If displayed address or attribute is LOSSNAY, indoor unit detects abnormality when indoor unit transmits signal to LOSSNAY and there was no reply (ACK).	① If the power supply of LOSSNAY is off, indoor unit detects abnormality when it transmits signal to LOSSNAY. ② During sequential operation of indoor unit and LOSSNAY of other refrigerant system, if indoor unit transmits signal to LOSSNAY while outdoor unit power supply of same refrigerant system with LOSSNAY is turned off or within 2 minutes of restart, abnormality is detected. ③ Contact failure of transmission wire of indoor unit of LOSSNAY ④ Disconnection of transmission connector (CN2M) of indoor unit ⑤ Defective transmitting receiving circuit of indoor unit or LOSSNAY	
	7. If displayed address or attribute is nonexistent.	① The unit of former address does not exist as address switch has changed while the unit was energized. ② Abnormality is detected when indoor unit transmits signal because the address of FRESH MASTER and LOSSNAY are changed after sequential operation of FRESH MASTER and LOSSNAY by remote controller.	



Check code	Abnormal point and detection method	Case	Judgment and action
A8 (6608)	<p>M-NET NO RESPONSE</p> <p>Abnormal if a message was transmitted and there were reply (ACK) that message was received, but response command does not return. Transmitting side detects abnormality every 30 seconds, 6 times continuously.</p> <p>Note: The address and attribute displayed at remote controller indicate the controller that did not reply (ACK).</p>	<p>① Transmitting condition is repeated fault because of noise and the like.</p> <p>② Extinction of transmission wire voltage and signal is caused by over-range transmission wire.</p> <ul style="list-style-type: none"> • Maximum distance....200 m • Remote controller line (12 m) <p>③ Extinction of transmission wire voltage and signal is caused by type-unmatched transmission wire.</p> <p>Type....</p> <ul style="list-style-type: none"> With shield wire- CVVS, CPEVS With normal wire (no shield)- VCTF, VCTFK, CVV CVS, VVR, VVF, VCT <p>Diameter....1.25 mm² or more</p> <p>④ Accidental malfunction of abnormality-generated controller</p>	<p>① Check transmission waveform or noise on transmission wire.</p> <p>② Turn off the power supply of outdoor unit and indoor unit and FRESH MASTER or LOSSNAY at the same time for 2 minutes or more, and turn the power on again. If malfunction was accidental, the unit returns to normal. If the same abnormality generates again, controller of displayed address and attribute may be defective.</p>

10-5. TROUBLESHOOTING OF PROBLEMS

Phenomena	Factor	Countermeasure
1. Remote controller display does not work.	<p>① 12 V DC is not supplied to remote controller. (Power supply display ● is not indicated on LCD.)</p> <p>② 12–15 V DC is supplied to remote controller, however, no display is indicated.</p> <ul style="list-style-type: none"> • “PLEASE WAIT” is not displayed. • “PLEASE WAIT” is displayed. 	<p>① Check LED2 on indoor controller board.</p> <p>(1) When LED2 is lit. Check the remote controller wiring for breaking or contact failure.</p> <p>(2) When LED2 is blinking. Check short circuit of remote controller wiring.</p> <p>(3) When LED2 is not lit. Refer to No.3 below.</p> <p>② Check the following.</p> <ul style="list-style-type: none"> • Failure of remote controller if “PLEASE WAIT” is not displayed • Refer to No.2 below if “PLEASE WAIT” is displayed.
2. “PLEASE WAIT” display is remained on the remote controller.	<p>① At longest 2 minutes after the power supply “PLEASE WAIT” is displayed to start up.</p> <p>② Communication error between the remote controller and indoor unit</p> <p>③ Communication error between the indoor and outdoor unit</p> <p>④ Outdoor unit protection device connector is open.</p>	<p>① Normal operation</p> <p>② Self-diagnosis of remote controller</p> <p>③ “PLEASE WAIT” is displayed for 6 minutes at most in case of indoor/outdoor unit communication error. Check LED3 on indoor controller board.</p> <p>(1) When LED3 is not blinking. Check indoor/outdoor connecting wire for miswiring. (Converse wiring of S1 and S2, or break of S3 wiring.)</p> <p>(2) When LED3 is blinking. Indoor/outdoor connecting wire is normal.</p> <p>④ Check LED display on outdoor controller circuit board. Refer to “10-9.TEST POINT DIAGRAM”. Check protection device connector (63L and 63H) for contact failure. Refer to “10-8. EMERGENCY OPERATION”.</p>
3. When pressing the remote controller operation switch, the OPERATION display is appeared but it will be turned off soon.	After cancelling to select function from the remote controller, the remote controller operation switch will be not accepted for approx. 30 seconds.	Normal operation



Phenomena	Factor	Countermeasure
4. Even controlling by the wireless remote controller, no beep is heard and the unit does not start operating. Operation display is indicated on wireless remote controller.	The pair number settings of the wireless remote controller and indoor controller board are mismatched.	Check the pair number settings.
5. When operating by the wireless remote controller, beep sound is heard, however, unit does not start operating.	① No operation for 2 minutes at most after the power supply ON. ② Local remote controller operation is prohibited. • Remote controlling adaptor is connected to CN32 on the indoor controller board. • Local remote controller operation is prohibited by centralized controller etc. since it is connected to MELANS. ③ Factor of No.2.	① Normal operation ② Normal operation ③ Check the phenomena of No.2.
6. Remote controller display works normally and the unit performs cooling operation, however, the capacity cannot be fully obtained. (The air does not cool well.)	① Refrigerant shortage ② Filter clogging ③ Heat exchanger clogging ④ Air duct short cycle	① If refrigerant leaks, discharging temperature rises and LEV opening increases. Inspect leakage by checking the temperature and opening. Check pipe connections for gas leakage. ② Open suction grille and check the filter. Clean the filter by removing dirt or dust on it. ③ If the filter is clogged, indoor pipe temperature rises and discharging pressure increases. Check if heat exchanger is clogged by inspecting discharging pressure. • Clean the heat exchanger. ④ Remove the blockage.
7. Remote controller display works normally and the unit performs heating operation, however, the capacity cannot be fully obtained.	① Linear expansion valve fault Opening cannot be adjusted well due to linear expansion valve fault. ② Refrigerant shortage ③ Lack of insulation for refrigerant piping ④ Filter clogging ⑤ Heat exchanger clogging ⑥ Air duct short cycle ⑦ Bypass circuit of outdoor unit fault	① Discharging temperature and indoor heat exchanger temperature does not rise. Inspect the failure by checking discharging pressure. Replace linear expansion valve. ② If refrigerant leaks, discharging temperature rises and LEV opening increases. Inspect leakage by checking the temperature and opening. Check pipe connections for gas leakage. ③ Check the insulation. ④ Open suction grille and check the filter. Clean the filter by removing dirt or dust on it. ⑤ If the filter is clogged, indoor pipe temperature rises and discharging pressure increases. Check if heat exchanger is clogged by inspecting discharging pressure. Clean the heat exchanger. ⑥ Remove the blockage. ⑦ Check refrigerant system during operation.
8. ① For 3 minutes after temperature adjuster turns off, the compressor will not start operating even if temperature adjuster is turned on. ② For 3 minutes after temperature adjuster turns on, the compressor will not stop operating even if temperature adjuster is turned off. (Compressor stops operating immediately when turning off by the remote controller.)	①② Normal operation (For protection of compressor)	①② Normal operation



Phenomena	Countermeasure
A flowing water sound or occasional hissing sound is heard.	<ul style="list-style-type: none"> These sounds can be heard when refrigerant and/or water is (are) flowing in the indoor unit or refrigerant pipe, or when the refrigerant and/or water is (are) chugging.
Water does not heat or cool well.	<ul style="list-style-type: none"> Clean the filter of water piping. (Flow is reduced when the filter is dirty or clogged.) Check the temperature adjustment and adjust the set temperature. Make sure that there is plenty of space around the outdoor unit.
Water or vapour is emitted from the outdoor unit.	<ul style="list-style-type: none"> During cooling mode, water may form and drip from the cool pipes and joints. During heating mode, water may form and drip from the heat exchanger of outdoor unit. During defrosting mode, water on the heat exchanger of outdoor unit evaporates and water vapour may be emitted.
The operation indicator does not appear in the remote controller display.	<ul style="list-style-type: none"> Turn on the power switch. "●" will appear in the remote controller display.
"☒" appears in the remote controller display.	<ul style="list-style-type: none"> During external signal control, "☒" appears in the remote controller display and FTC operation cannot be started or stopped using the remote controller.
When restarting the outdoor unit soon after stopping it, it does not operate even though the ON/OFF button is pressed.	<ul style="list-style-type: none"> Wait approximately 3 minutes. (Operation has stopped to protect the outdoor unit.)
FTC operates without the ON/OFF button being pressed.	<ul style="list-style-type: none"> Is the on timer set? Press the ON/OFF button to stop operation. Is the FTC connected to a external signal? Consult the concerned people who control the FTC. Does "☒" appear in the remote controller display? Consult the concerned people who control the FTC. Has the auto recovery feature from power failures been set? Press the ON/OFF button to stop operation.
FTC stops without the ON/OFF button being pressed.	<ul style="list-style-type: none"> Is the off timer set? Press the ON/OFF button to restart operation. Is the air conditioner connected to a central remote controller? Consult the concerned people who control the FTC. Does "☒" appear in the remote controller display? Consult the concerned people who control the FTC.
Remote controller timer operation cannot be set.	<ul style="list-style-type: none"> Are timer settings invalid? If the timer can be set, (WEEKLY), (SIMPLE), or (AUTO OFF) appears in the remote controller display.
"PLEASE WAIT" appears in the remote controller display.	<ul style="list-style-type: none"> The initial settings are being performed. Wait approximately 3 minutes. If the remote controller is not only for FTC, change it.
A check code appears in the remote controller display.	<ul style="list-style-type: none"> The protection devices have operated to protect the FTC and outdoor unit. Do not attempt to repair this equipment by yourself. Turn off the power switch immediately and consult your dealer. Be sure to provide the dealer with the model name and information that appeared in the remote controller display.

• If the unit cannot be operated properly after test run, refer to the following table to find the cause.

Symptom		Cause
Wired remote controller	LED 1, 2 (PCB in outdoor unit)	
PLEASE WAIT	For about 2 minutes after power-on After LED 1, 2 are lit, LED 2 is turned off, then only LED 1 is lit. (Correct operation)	• For about 2 minutes following power-on, operation of the remote controller is not possible due to system startup. (Correct operation)
PLEASE WAIT → Check code	Subsequent to about 2 minutes after power-on	<ul style="list-style-type: none"> Connector for the outdoor unit's protection device is not connected. Reverse or open phase wiring for the outdoor unit's power terminal block (L1, L2, L3)
Display messages do not appear even when operation switch is turned ON (operation lamp does not light up).		

Note: Operation is not possible for about 30 seconds after cancellation of function selection. (Correct operation)

For description of each LED (LED1, 2, 3) provided on the FTC, refer to the following table.

LED1 (power for microprocessor)	Indicates whether control power is supplied. Make sure that this LED is always lit.
LED2 (power for remote controller)	Indicates whether power is supplied to the remote controller. This LED lights only in the case of the FTC which is connected to the outdoor unit refrigerant addresses "0".
LED3 (communication between FTC and outdoor units)	Indicates state of communication between the FTC and outdoor units. Make sure that this LED is always blinking.

Symptoms: "PLEASE WAIT" is kept being displayed on the remote controller.





Diagnosis flow	Cause	Inspection method and troubleshooting
<pre> graph TD Start[Check the display time of "PLEASE WAIT" after turning on the main power.] --> D1{How long is "PLEASE WAIT" kept being displayed on the remote controller?} D1 -- "6 minutes or more" --> Step1[Check the LED display of the outdoor controller circuit board.] D1 -- "2 to 6 minutes" --> D2{Are any check codes displayed on the remote controller?} D1 -- "2 minutes or less" --> Cause1["PLEASE WAIT" will be displayed during the startup diagnosis after turning on the main power.] D2 -- NO --> Cause1 D2 -- YES --> Step2[Check the LED display of the outdoor controller circuit board.] Step1 --> D3{Are any check codes displayed on the LED?} D3 -- NO --> Cause2["Defective indoor controller board", "Defective remote controller"] D3 -- YES --> Cause3["Miswiring of indoor/outdoor connecting wire", "Breaking of indoor/outdoor connecting wire (S3)", "Defective indoor controller board", "Defective outdoor controller circuit board"] </pre>	<ul style="list-style-type: none"> • "PLEASE WAIT" will be displayed during the startup diagnosis after turning on the main power. • Miswiring of indoor/outdoor connecting wire • Breaking of indoor/outdoor connecting wire (S3) • Defective indoor controller board • Defective outdoor controller circuit board • Defective indoor controller board • Defective remote controller 	<ul style="list-style-type: none"> • Normal. The startup diagnosis will be over in around 2 minutes. • Refer to "Self-diagnosis action table" in order to solve the trouble. • In case of communication errors, the display of remote controller may not match the LED display of the outdoor unit.

Symptoms: Nothing is displayed on the remote controller. ①

LED display of the indoor controller board
 LED1 : ○
 LED2 : ○
 LED3 : ○

Diagnosis flow	Cause	Inspection method and troubleshooting
<pre> graph TD Start[Check the voltage between S1 and S2 on the terminal block (TB4) of the indoor unit which is used to connect the indoor unit and the outdoor unit.] --> D1{198 to 264 V AC?} D1 -- NO --> S1[Check the voltage among L(L3) and N on the terminal block (TB1) of the outdoor power circuit board.] D1 -- YES --> S2[Check the voltage of indoor controller board (CN2D).] S1 --> D2{198 to 264 V AC?} D2 -- NO --> C1[• Troubles concerning power supply] D2 -- YES --> S3[Check the voltage between S1 and S2 on the terminal block (TB1) of the outdoor unit which is used to connect the indoor unit and the outdoor unit.] S3 --> D3{198 to 264 V AC?} D3 -- NO --> C2[• Bad wiring of the outdoor controller board • The fuses on the outdoor controller circuit board are melting.] D3 -- YES --> S4[Check the voltage of indoor controller board (CN2D).] S4 --> D4{12 V to 16 V DC?} D4 -- YES --> C3[• Bad wiring of the outdoor controller board • The fuses on the outdoor controller circuit board are melting.] D4 -- NO --> S5[Check the voltage of the unit after removing the indoor power board (CN2S).] S5 --> D5{12 V to 16 V DC?} D5 -- YES --> C4[• Miswiring, breaking or poor connection of indoor/outdoor connecting wire] D5 -- NO --> C5[• Defective indoor power board] </pre>	<ul style="list-style-type: none"> • Troubles concerning power supply • Bad wiring of the outdoor controller board • The fuses on the outdoor controller circuit board are melting. • Bad wiring of the outdoor controller board • The fuses on the outdoor controller circuit board are melting. • Defective indoor controller board • Miswiring, breaking or poor connection of indoor/outdoor connecting wire • Defective indoor power board 	<ul style="list-style-type: none"> • Check the power wiring to the outdoor unit. • Check the breaker. • Check the wiring of the outdoor unit. • Check if the wiring is bad. The fuses on the outdoor controller circuit board will be melting when the indoor /outdoor connecting wire short-circuits. • Check if miswiring, breaking or poor contact is causing this problem. Indoor/outdoor connecting wire is polarized 3-core type. Connect the indoor unit and the outdoor unit by wiring each pair of S1, S2 and S3 on the both side of indoor/outdoor terminal blocks. • Replace the indoor controller board. • Check if there is miswiring or breaking of wire. • Replace the indoor power board.

Symptoms: Nothing is displayed on the remote controller. ②

LED display of the indoor controller board
 LED1 : 
 LED2 : 
 LED3 :  or 

Diagnosis flow	Cause	Inspection method and troubleshooting
<p>Check the voltage between S1 and S2 on the terminal block (TB4) of the indoor unit which is used to connect the indoor unit and the outdoor unit.</p> <p>198 to 264 V AC?</p> <p>NO → Check the looseness or disconnection of the indoor/outdoor connecting wire.</p> <p>YES → Check the status of the indoor controller board LED3 display.</p> <p>Not lighting. → Check the looseness or disconnection of the indoor/outdoor connecting wire.</p> <p>Blinking. → Are there looseness or disconnection of the indoor/outdoor connecting wire?</p> <p>NO → Check the refrigerant address of the outdoor unit. (SW1-3 to 1-6)</p> <p>YES → Is the refrigerant address "0"?</p> <p>NO → Normal Only the unit which has the refrigerant address "0" supplies power to the remote controller</p> <p>YES → Check the LED display of the outdoor unit after turning on the main power again.</p> <p>Is anything displayed?</p> <p>Not displayed. → Defective outdoor controller circuit board</p> <p>Displayed. → Is "EA" or "Eb" displayed?</p> <p>NO → Is "E8" displayed?</p> <p>YES → Defective outdoor controller circuit board</p> <p>NO → Can the unit be restarted?</p> <p>Can all the indoor unit be operated?</p> <p>NO → Defective indoor controller board</p> <p>YES → Influence of electromagnetic noise</p> <p>Check the voltage between S2 and S3 on the terminal block of the outdoor unit.</p> <p>17 to 28 V DC?</p> <p>NO → Defective outdoor power circuit board</p> <p>YES → Defective indoor power board</p>	<ul style="list-style-type: none"> • Breaking or poor contact of the indoor/outdoor connecting wire • Normal Only the unit which has the refrigerant address "0" supplies power to the remote controller • Defective outdoor controller circuit board • Defective outdoor controller circuit board • Defective indoor controller board • Influence of electromagnetic noise • Defective outdoor power circuit board • Defective indoor power board 	<ul style="list-style-type: none"> • Fix the breaking or poor contact of the indoor/outdoor connecting wire. • Set the refrigerant address to "0". In case of the multiple grouping system, recheck the refrigerant address again. • Replace the outdoor controller circuit board. • Replace the outdoor controller circuit board. • Replace the indoor controller board of the indoor unit which does not operate. • Not abnormal. There may be the influence of electromagnetic noise. Check the transmission wire and get rid of the causes. • Replace the outdoor power circuit board. • Replace the indoor power board.

Symptoms: Nothing is displayed on the remote controller. ③

LED display of the indoor controller board
 LED1 : ●
 LED2 : ● or ●
 LED3 : —

Diagnosis flow	Cause	Inspection method and troubleshooting
<pre> graph TD A[Check the voltage of the terminal block (TB6) of the remote controller.] --> B{10 to 16 V DC?} B -- YES --> C[Defective remote controller] B -- NO --> D{Check the status of the LED2.} D -- Lighting --> E[Breaking or poor contact of the remote controller wire] D -- Blinking --> F[Check the status of the LED2 after disconnecting the remote controller wire from the terminal block (TB5) of the indoor unit.] F -- Lighting --> G[The remote controller wire short-circuits] F -- Blinking --> H[Defective indoor controller board] </pre>	<ul style="list-style-type: none"> • Defective remote controller • Breaking or poor contact of the remote controller wire • The remote controller wire short-circuits • Defective indoor controller board 	<ul style="list-style-type: none"> • Replace the remote controller. • Check if there is breaking or poor contact of the remote controller wire. Check the voltage of the terminal block (TB5) connecting the remote controller wire. If it is not between DC 10V and DC16V, the indoor controller board must be defective. • Check if the remote controller wire is short-circuited. • Replace the indoor controller board.

• Before repair

Frequent calling from customers

Phone Calls From Customers		How to Respond	Note
Unit does not operate at all.	① The operating display of remote controller does not come on.	① Check if power is supplied to air conditioner. Nothing appears on the display unless power is supplied.	_____
	② Unit cannot be restarted for a while after it has stopped.	② Wait around 3 minutes to restart unit. The air conditioner is in a state of being protected by the microcomputer's directive. Once the compressor is stopped, the unit cannot be restarted for 3 minutes. This control is also applied when the unit is turned on and off by remote controller.	_____
	③ Check code appears and blinks on the display of remote controller.	③ Check code will be displayed if any protection devices of the air conditioner are actuated. What is check code?-----	Refer to "SELF-DIAGNOSIS ACTION TABLE". ▶ Check if servicing is required for the error.
Remote controller	① "PLEASE WAIT" is displayed on the screen.	① Wait around 2 minutes. An automatic startup test will be conducted for 2 minutes when power is supplied to the air conditioner. "PLEASE WAIT" will be kept being displayed while that time.	_____
	② "FILTER" is displayed on the screen.	② This indicates that it is time to clean the air filters. Clean the air filters. Press the FILTER button on the remote controller twice to clear "FILTER" from the display. See the operation manual that came with the product for how to clean the filters.	Display time of "FILTER" depends on the model. Long life filter: 2500 hrs. Regular filter: 100 hrs.
	③ "STANDBY" is displayed on the screen.	③ This is displayed when the unit starts HEAT operation, when the thermostat puts the compressor in operation mode, or when the outdoor unit ends DEFROST operation and returns to HEAT operation. The display will automatically disappear around 10 minutes later. While "STANDBY" is displayed on the remote controller, the airflow amount will be restricted because the indoor unit's heat exchanger is not fully heated up. In addition to that, the up/down vane will be automatically set to horizontal blow in order to prevent cold air from directly blowing out to human body. The up/down vane will return to the setting specified by the remote controller when "STANDBY" is released.	_____
	④ "DEFROST" is displayed on the screen. (No air comes out of the unit.)	④ The outdoor unit gets frosted when the outside temperature is low and the humidity is high. "DEFROST" indicates the DEFROST operation is being performed to melt this frost. The DEFROST operation ends in around 10 minutes (at most 15 minutes). During the DEFROST operation, the indoor unit's heat exchanger becomes cold, so the fan is stopped. The up/down vane will be automatically set to horizontal blow in order to prevent cold air from directly blowing out to human body. The display will turn into "STANDBY" when DEFROST operation ends.	_____

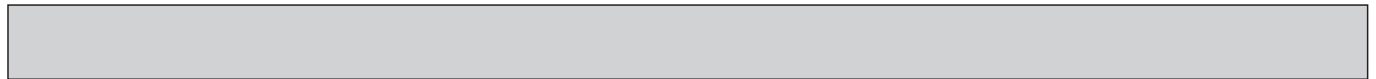

Phone Calls From Customers		How to Respond	Note
The room cannot be cooled or heated sufficiently.	① Check the set temperature of remote controller. The outdoor unit cannot be operated if the set temperature is not appropriate. The outdoor unit operates in the following modes. COOL: When the set temperature is lower than the room temperature. HEAT: When the set temperature is higher than the room temperature.	_____	
	② Check if filters are not dirty and clogged. If filters are clogged, the airflow amount will be reduced and the unit capacity will be lowered. See the instruction manual that came with the product for how to clean the filters.	_____	
	③ Check there is enough space around the air conditioner. If there are any obstacles in the air intake or air outlet of indoor/outdoor units, they block the airflow direction so that the unit capacity will be lowered.	_____	
Sound comes out from the air conditioner.	① A gas escaping sound is heard sometimes.	① This is not a malfunction. This is the sound which is heard when the flow of refrigerant in the air conditioner is switched.	_____
	② A cracking sound is heard sometimes.	② This is not a malfunction. This is the sound which is heard when internal parts of units expand or contract when the temperature changes.	_____
	③ A buzzing sound is heard sometimes.	③ This is not a malfunction. This is the sound which is heard when the outdoor unit starts operating.	_____
	④ A ticking sound is heard from the outdoor unit sometimes.	④ This is not a malfunction. This is the sound which is heard when the fan of the outdoor unit is controlling the airflow amount in order to keep the optimum operating condition.	_____
	⑤ A sound, similar to water flowing, is heard from the unit.	⑤ This is not a malfunction. This is the sound which is heard when the refrigerant is flowing inside the indoor unit.	_____
Something is wrong with the blower.....	① The fan speed does not match the setting of the remote controller during DRY operation.(No air comes out sometimes during DRY operation.)	① This is not a malfunction. During the DRY operation, the blower's ON/OFF is controlled by the microprocessor to prevent overcooling and to ensure efficient dehumidification. The fan speed cannot be set by the remote controller during DRY operation.	_____
	② The fan speed does not match the setting of the remote controller in HEAT operation.	② This is not a malfunction. 1) When the HEAT operation starts, to prevent the unit from blowing cold air, the fan speed is gradually increased from zero to the set speed, in proportion to the temperature rise of the discharged air. 2) When the room temperature reaches the set temperature and the outdoor unit stops, the unit starts the LOW AIR operation. 3) During the HEAT operation, the DEFROST operation is performed to defrost the outdoor unit. During the DEFROST operation, the blower is stopped to prevent cold air coming out of the indoor unit.	The up/down vane will be automatically set to horizontal blow in these cases listed up on the left (1)~3)). After a while, the up/down vane will be automatically moved according to the setting of the remote controller.



Phone Calls From Customers		How to Respond	Note
Something is wrong with the blower.....	③ Air blows out for a while after HEAT operation is stopped.	③ This is not a malfunction. The blower is operating just for cooling down the heated-up air conditioner. This will be done within 1 minute. This control is conducted only when the HEAT operation is stopped with the electric heater ON.	However, this control is also applied to the models which has no electric heater.
Something is wrong with the airflow direction....	① The airflow direction is changed during COOL operation.	① If the up/down vane is set to downward in COOL operation, it will be automatically set to horizontal blow by the microprocessor in order to prevent water from dropping down. "1 Hr." will be displayed on the remote controller if the up/down vane is set to downward with the fan speed set to be less than "LOW".	_____
	② The airflow direction is changed during HEAT operation. (The airflow direction cannot be set by remote controller.)	② In HEAT operation, the up/down vane is automatically controlled according to the temperature of the indoor unit's heat exchanger. In the following cases written below, the up/down vane will be set to horizontal blow, and the setting cannot be changed by remote controller. 1) At the beginning of the HEAT operation 2) While the outdoor unit is being stopped by thermostat or when the outdoor unit gets started to operate. 3) During DEFROST operation The airflow direction will be back to the setting of remote controller when the above situations are released.	"STANDBY" will be displayed on the remote controller in case of 1) and 2). "DEFROST" will be displayed on the screen in case of 3).
	③ The airflow direction does not change. (Up/down vane, left/right louver)	③ 1) Check if the vane is set to a fixed position. (Check if the vane motor connector is removed.) 2) Check if the air conditioner has a function for switching the air direction. 3) If the air conditioner does not have that function, "NOT AVAILABLE" will be displayed on the remote controller when "AIR DIRECTION" or "LOUVER" button is pressed.	_____
The air conditioner starts operating even though any buttons on the remote controller are not pressed.	① Check if you set ON/OFF timer. The air conditioner starts operating at the time designated if ON timer has been set before.	_____	
	② Check if any operations are ordered by distant control system or the central remote controller. While "CENTRALLY CONTROLLED INDICATOR" is displayed on the remote controller, the air conditioner is under the control of external directive.	There might be a case that "CENTRALLY CONTROLLED INDICATOR" will not be displayed.	
	③ Check if power is recovered from power failure (black out). The units will automatically start operating when power is recovered after power failure (black out) occurs. This function is called "power failure automatic recovery".	_____	
The air conditioner stops even though any buttons on the remote controller are not pressed.	① Check if you set ON/OFF timer. The air conditioner stops operating at the time designated if OFF timer has been set before.	There might be a case that "CENTRALLY CONTROLLED INDICATOR" will not be displayed.	
	② Check if any operations are ordered by distant control system or the central remote controller. While "CENTRALLY CONTROLLED INDICATOR" is displayed on the remote controller, the air conditioner is under the control of external directive.		

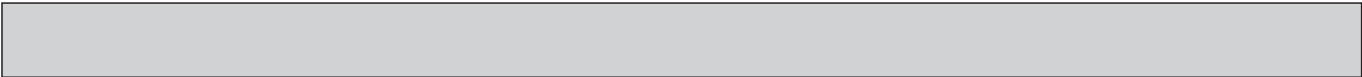

Phone Calls From Customers	How to Respond	Note
A white mist is expelled from the indoor unit.	This is not a malfunction. This may occur when the operation gets started in the room of high humidity.	_____
Water or moisture is expelled from the outdoor unit.	COOL: when pipes or piping joints are cooled, they get sweated and water drips down. HEAT: water drips down from the heat exchanger. Note: Make use of optional parts "Drain Socket" and "Drain pan" if these water needs to be recovered and drained out for once.	_____
The display of wireless remote controller gets dim or does not come on. The indoor unit does not receive a signal from remote controller at a long distance.	Batteries are being exhausted. Replace them and press the reset button of remote controller.	_____

10-6. HOW TO CHECK THE PARTS

PUHZ-SHW80VHA	PUHZ-SHW80VHAR2.UK	PUHZ-SHW80VHAR3.UK	PUHZ-SHW80VHAR4.UK
	PUHZ-SHW80VHAR2-BS.UK	PUHZ-SHW80VHAR3-BS.UK	PUHZ-SHW80VHAR4-BS.UK
PUHZ-SHW112VHA	PUHZ-SHW112VHAR2.UK	PUHZ-SHW112VHAR3.UK	PUHZ-SHW112VHAR4.UK
	PUHZ-SHW112VHAR2-BS.UK	PUHZ-SHW112VHAR3-BS.UK	PUHZ-SHW112VHAR4-BS.UK
PUHZ-SHW112YHA	PUHZ-SHW112YHAR2.UK	PUHZ-SHW112YHAR3.UK	PUHZ-SHW112YHAR4.UK
PUHZ-SHW112YHAR1	PUHZ-SHW112YHAR2-BS.UK	PUHZ-SHW112YHAR3-BS.UK	PUHZ-SHW112YHAR4-BS.UK
PUHZ-SHW140YHA	PUHZ-SHW140YHAR2.UK	PUHZ-SHW140YHAR3.UK	PUHZ-SHW140YHAR4.UK
PUHZ-SHW140YHAR1	PUHZ-SHW140YHAR2-BS.UK	PUHZ-SHW140YHAR3-BS.UK	PUHZ-SHW140YHAR4-BS.UK
PUHZ-SHW140YHAR5.UK			
PUHZ-SHW140YHAR5-BS.UK			

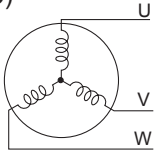
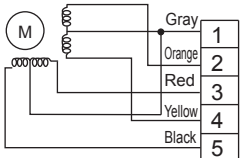
Parts name	Check points														
Thermistor (TH3) <Liquid> Thermistor (TH4) <Discharge> Thermistor (TH6) <2-phase pipe> Thermistor (TH7) <Ambient> Thermistor (TH8) <Heat sink> (SHW112/140Y only) Thermistor (TH32) <Suction> Thermistor (TH33) <Ref. check> Thermistor (TH34) <Comp. surface>	Disconnect the connector then measure the resistance with a tester. (At the ambient temperature 10 to 30 °C) <table border="1" style="margin-top: 10px;"> <thead> <tr> <th></th> <th>Normal</th> <th>Abnormal</th> </tr> </thead> <tbody> <tr> <td>TH4 TH34</td> <td>160 to 410 kΩ</td> <td rowspan="4">Open or short</td> </tr> <tr> <td>TH3 TH6 TH7 TH32 TH33</td> <td>4.3 to 9.6 kΩ</td> </tr> <tr> <td>TH8</td> <td>39 to 105 kΩ</td> </tr> </tbody> </table>		Normal	Abnormal	TH4 TH34	160 to 410 kΩ	Open or short	TH3 TH6 TH7 TH32 TH33	4.3 to 9.6 kΩ	TH8	39 to 105 kΩ				
	Normal	Abnormal													
TH4 TH34	160 to 410 kΩ	Open or short													
TH3 TH6 TH7 TH32 TH33	4.3 to 9.6 kΩ														
TH8	39 to 105 kΩ														
Fan motor (MF1, MF2)	Refer to the next page.														
Solenoid valve coil <4-way valve> (21S4)	Measure the resistance between the terminals with a tester. (At the ambient temperature 20 °C) <table border="1" style="margin-top: 10px;"> <thead> <tr> <th>Normal</th> <th>Abnormal</th> </tr> </thead> <tbody> <tr> <td>1435 ± 150 Ω</td> <td>Open or short</td> </tr> </tbody> </table>	Normal	Abnormal	1435 ± 150 Ω	Open or short										
Normal	Abnormal														
1435 ± 150 Ω	Open or short														
Motor for compressor (MC) 	Measure the resistance between the terminals with a tester. (Winding temperature 20 °C) <table border="1" style="margin-top: 10px;"> <thead> <tr> <th colspan="3">Normal</th> <th>Abnormal</th> </tr> </thead> <tbody> <tr> <td>80/112VHA</td> <td>112/140YHA(R1)</td> <td>112/140YHAR2(R3/R4/R5)</td> <td rowspan="2">Open or short</td> </tr> <tr> <td>0.188 Ω</td> <td>0.302 Ω</td> <td>0.305 Ω</td> </tr> </tbody> </table>	Normal			Abnormal	80/112VHA	112/140YHA(R1)	112/140YHAR2(R3/R4/R5)	Open or short	0.188 Ω	0.302 Ω	0.305 Ω			
Normal			Abnormal												
80/112VHA	112/140YHA(R1)	112/140YHAR2(R3/R4/R5)	Open or short												
0.188 Ω	0.302 Ω	0.305 Ω													
Linear expansion valve (LEV-A/LEV-B/LEV-C) 	Disconnect the connector then measure the resistance with a tester. (Winding temperature 20 °C) <table border="1" style="margin-top: 10px;"> <thead> <tr> <th colspan="4">Normal</th> <th>Abnormal</th> </tr> </thead> <tbody> <tr> <td>Gray - Black</td> <td>Gray - Red</td> <td>Gray - Yellow</td> <td>Gray - Orange</td> <td rowspan="2">Open or short</td> </tr> <tr> <td colspan="4" style="text-align: center;">46 ± 3Ω</td> </tr> </tbody> </table>	Normal				Abnormal	Gray - Black	Gray - Red	Gray - Yellow	Gray - Orange	Open or short	46 ± 3Ω			
Normal				Abnormal											
Gray - Black	Gray - Red	Gray - Yellow	Gray - Orange	Open or short											
46 ± 3Ω															

Check method of DC fan motor (fan motor/outdoor controller circuit board)

① Notes

- High voltage is applied to the connector (CNF1, 2) for the fan motor. Pay attention to the service.
- Do not pull out the connector (CNF1, 2) for the motor with the power supply on.
(It causes trouble of the outdoor controller circuit board and fan motor.)

② Self check

Symptom: The outdoor fan cannot rotate.

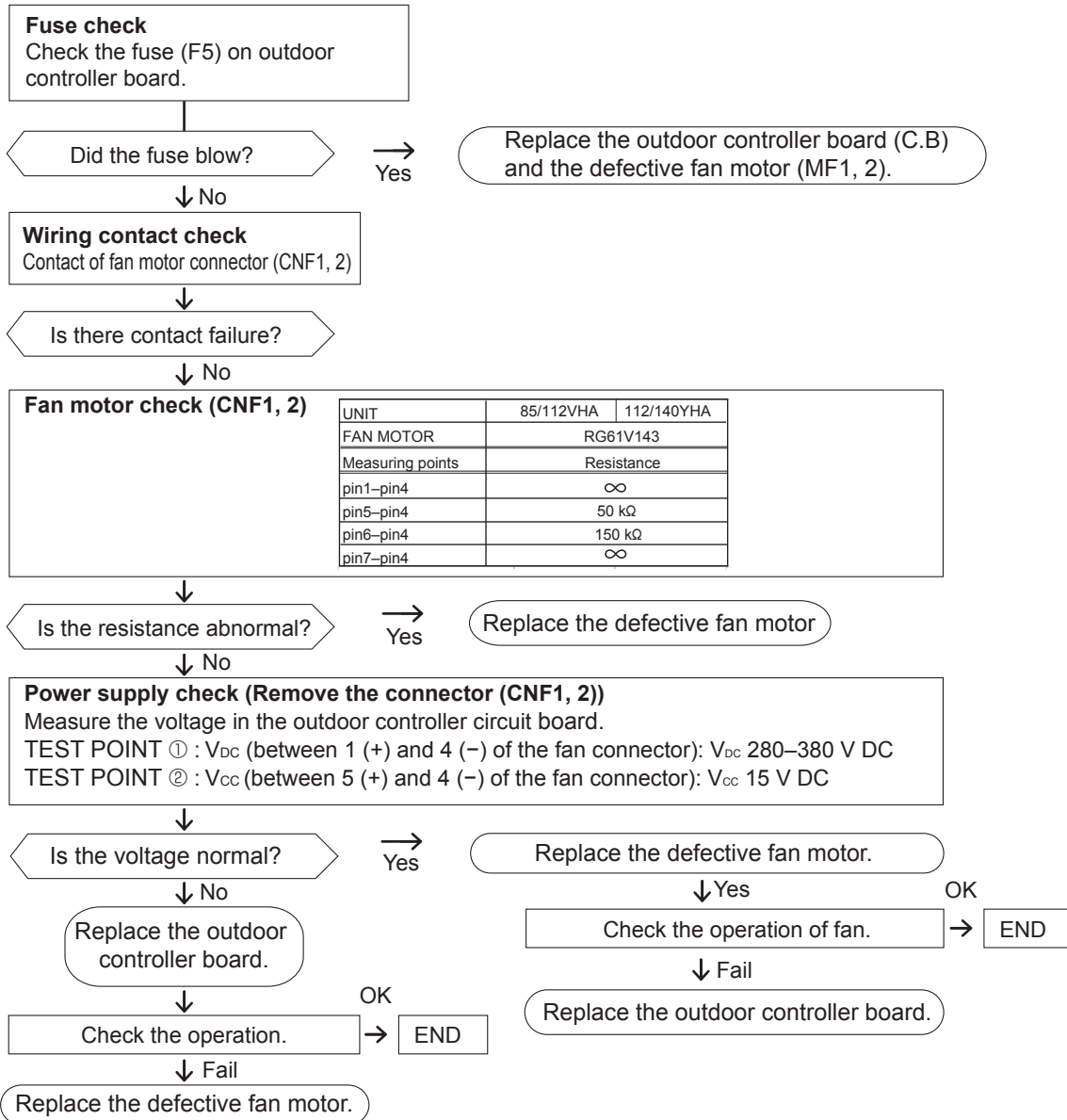

10-7. HOW TO CHECK THE COMPONENTS

<HIGH PRESSURE SENSOR>

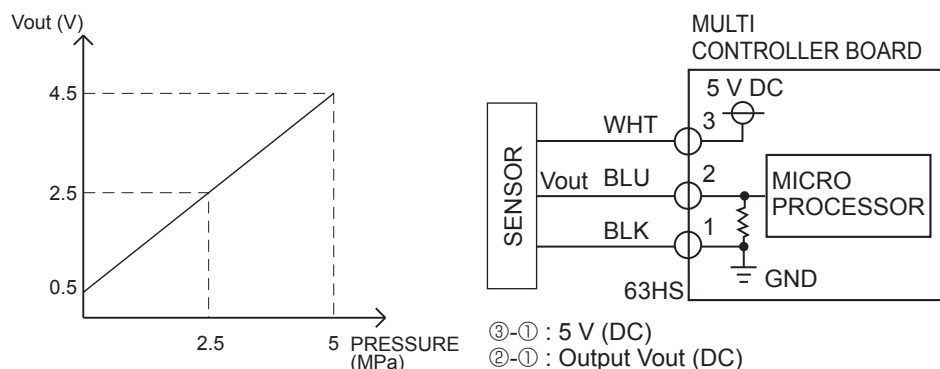

<Thermistor feature chart>

Low temperature thermistors

- Thermistor <Liquid> (TH3)
- Thermistor <2-phase pipe> (TH6)
- Thermistor <Ambient> (TH7)
- Thermistor <Suction> (TH32)
- Thermistor <Ref. check> (TH33)

Thermistor R0 = 15 kΩ ± 3 %
 B constant = 3480 ± 2 %

$$R_t = 15 \exp\left\{3480 \left(\frac{1}{273+t} - \frac{1}{273} \right)\right\}$$

0 °C	15 kΩ	30 °C	4.3 kΩ
10 °C	9.6 kΩ	40 °C	3.0 kΩ
20 °C	6.3 kΩ		
25 °C	5.2 kΩ		

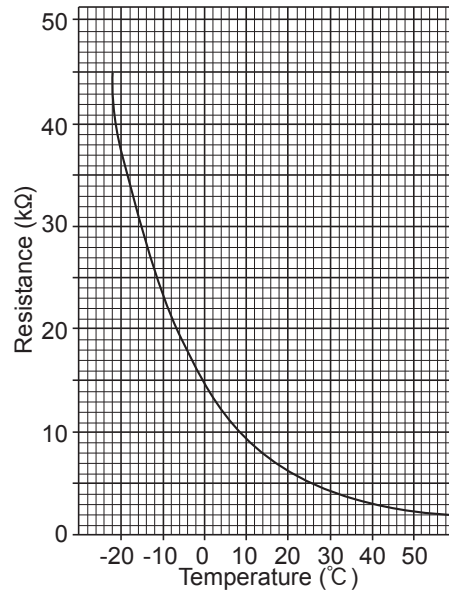

Medium temperature thermistor

- Thermistor <Heat sink> (TH8)
 (SHW112/140Y only)

Thermistor R50 = 17 kΩ ± 2 %
 B constant = 4150 ± 3 %

$$R_t = 17 \exp\left\{4150 \left(\frac{1}{273+t} - \frac{1}{323} \right)\right\}$$

0 °C	180 kΩ
25 °C	50 kΩ
50 °C	17 kΩ
70 °C	8 kΩ
90 °C	4 kΩ

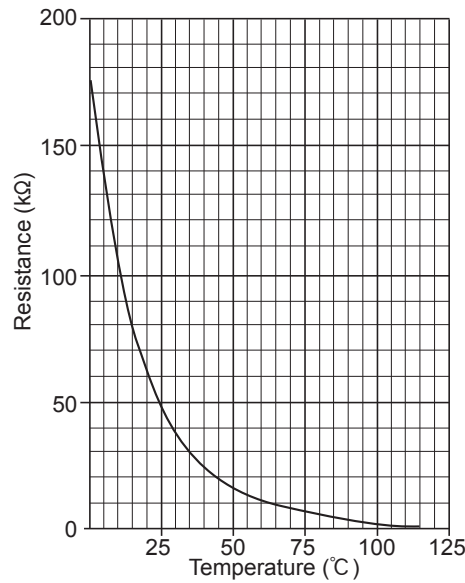

High temperature thermistor

- Thermistor <Discharge> (TH4)
- Thermistor <Comp. surface> (TH34)

Thermistor R120 = 7.465 kΩ ± 2 %
 B constant = 4057 ± 2 %

$$R_t = 7.465 \exp\left\{4057 \left(\frac{1}{273+t} - \frac{1}{393} \right)\right\}$$

20 °C	250 kΩ	70 °C	34 kΩ
30 °C	160 kΩ	80 °C	24 kΩ
40 °C	104 kΩ	90 °C	17.5 kΩ
50 °C	70 kΩ	100 °C	13.0 kΩ
60 °C	48 kΩ	110 °C	9.8 kΩ

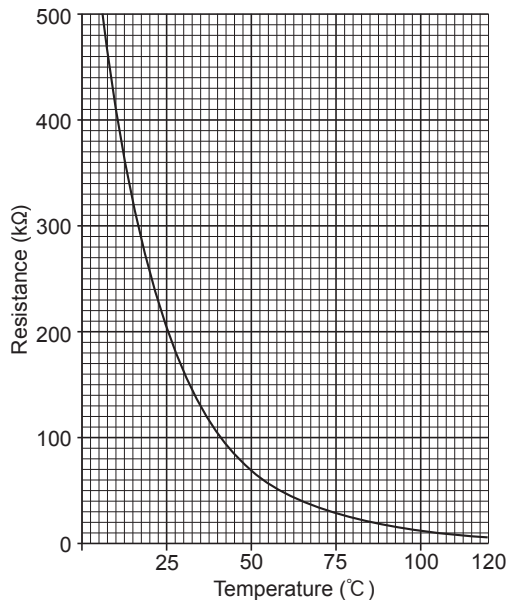

Linear expansion valve

(1) Operation summary of the linear expansion valve

- Linear expansion valve opens/closes through stepping motor after receiving the pulse signal from the outdoor controller board.
- Valve position can be changed in proportion to the number of pulse signal.

<Connection between the outdoor controller board and the linear expansion valve>

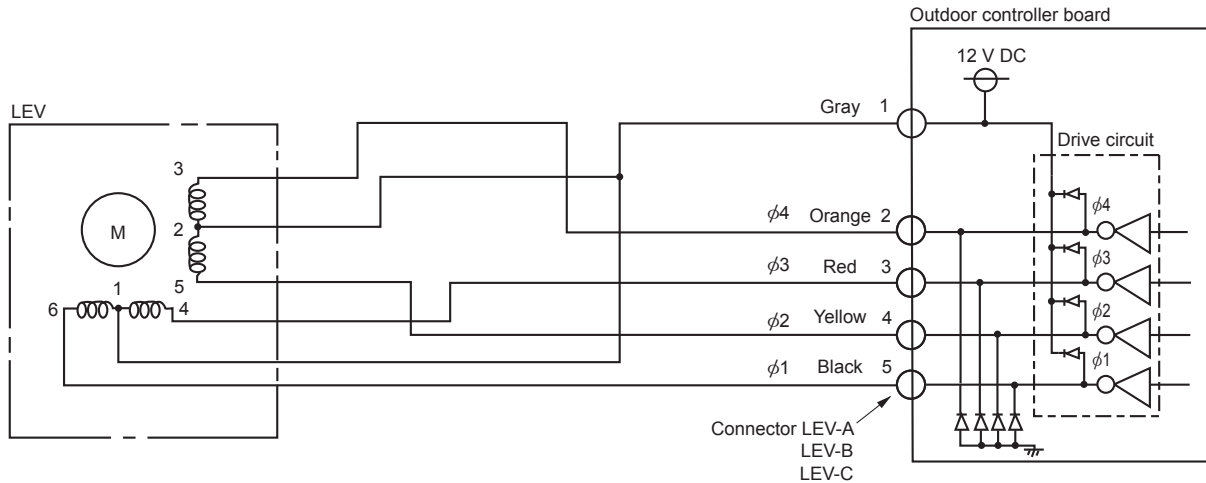

<Output pulse signal and the valve operation>

Output (Phase)	Output							
	1	2	3	4	5	6	7	8
$\phi 1$	ON	ON	OFF	OFF	OFF	OFF	OFF	ON
$\phi 2$	OFF	ON	ON	ON	OFF	OFF	OFF	OFF
$\phi 3$	OFF	OFF	OFF	ON	ON	ON	OFF	OFF
$\phi 4$	OFF	OFF	OFF	OFF	OFF	ON	ON	ON

Opening a valve : 8 → 7 → 6 → 5 → 4 → 3 → 2 → 1 → 8

Closing a valve : 1 → 2 → 3 → 4 → 5 → 6 → 7 → 8 → 1

The output pulse shifts in above order.

- When linear expansion valve operation stops, all output phases become OFF.
- When the power is turned on, 700 pulse closing valve signal will be sent till it goes to ㉞ point in order to define the valve position. (The pulse signal is being sent for about 20 seconds.)

(2) Linear expansion valve operation

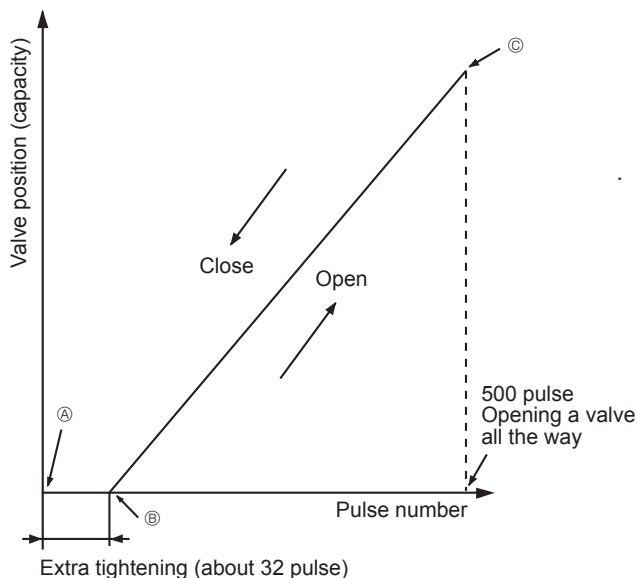

When the valve moves smoothly, there is no sound or vibration occurring from the linear expansion valve : however, when the pulse number moves from ㉞ to ㉟ or when the valve is locked, sound can be heard.

No sound is heard when the pulse number moves from ㉞ to ㉟ in case coil is burnt out or motor is locked by open-phase.

- Sound can be detected by placing the ear against the screw driver handle while putting the screw driver to the linear expansion valve.

(3) How to attach and detach the coil of linear expansion valve

<Composition>

Linear expansion valve is separable into the main body and the coil as shown in the diagram below.

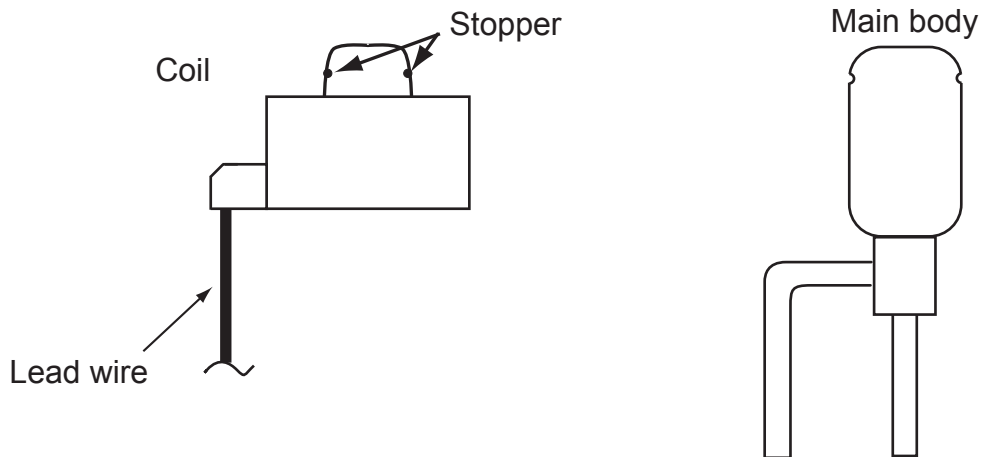

<How to detach the coil>

Hold the lower part of the main body (shown as A) firmly so that the main body does not move and detach the coil by pulling it upward.

Be sure to detach the coil holding main body firmly. Otherwise pipes can bend due to stress.

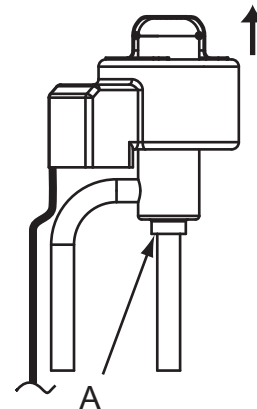

<How to attach the coil>

Hold the lower part of the main body (shown as A) firmly so that the main body does not move and attach the coil by inserting it downward into the main body. Then securely attach the coil stopper to main body. (At this time, be careful that stress is not added to lead wire and main body is not wound by lead wire.) If the stopper is not firmly attached to main body, coil may be detached from the main body and that can cause defective operation of linear expansion valve.

To prevent piping stress, be sure to attach the coil holding the main body of linear expansion valve firmly. Otherwise pipe may break.

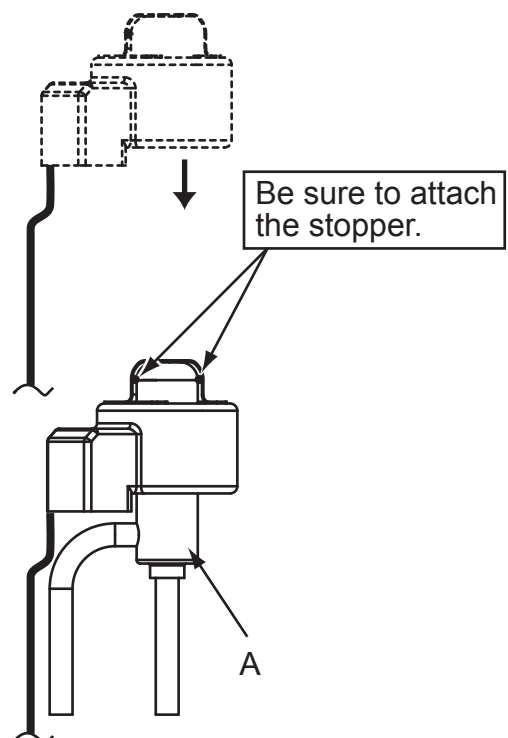

10-8. EMERGENCY OPERATION (FOR AIR-CONDITIONERS)

- (1) When any check codes shown below is displayed on outdoor unit, or microcomputer for wired remote controller or indoor unit has a failure while no other problems are found, emergency operation will be available by setting the emergency operation switch (SWE) ON and short-circuiting the connector (CN31) on outdoor controller board.

When following abnormalities occur, emergency operation will be available.

Check code	Inspected content
U4	Open/short of pipe thermistors (TH3/TH6/TH7/TH32/TH33/TH8)
UE	Open of pressure sensor (T _{63HS})
E8	Indoor/outdoor unit communication error •Signal receiving error (Outdoor unit)
E9	Indoor/outdoor unit communication error •Transmitting error (Indoor unit)
E0–E7	Communication error other than outdoor unit
Ed	Communication error between outdoor controller board and M-NET board (Serial communication error)

(2) Check the following items and cautions for emergency operation

- ① Make sure that there is no abnormality in outdoor unit other than the above abnormalities. (Emergency operation will not be available when check code other than the above are indicated.)
- ② For emergency operation, it is necessary to set the emergency operation switch (SWE) on indoor controller board. Refer to the electrical wiring diagram of indoor unit for how to set the indoor unit.
- ③ During emergency operation, the air-conditioner will continuously be operated by supplying power and stopping it: It cannot be turned on or off by remote control, and temperature control is not possible.
- ④ Do not perform emergency heating operation for an extended period of time: If the outdoor unit starts defrosting during this period, cold air will blow out from the indoor unit.
- ⑤ Do not perform emergency cooling operation for more than 10 hours: Neglecting this could result in freezing the heat exchanger in indoor unit.

(3) Emergency operation procedure

- ① Turn the main power supply off.
- ② Turn on the emergency operation switch (SWE) on indoor controller board.
- ③ Set the shorting pins of emergency operation connector (CN31) on outdoor controller board to ON.
- ④ Use SW4-2 on outdoor controller board to set the operation mode (cooling or heating). (SW4-1 is not used.)

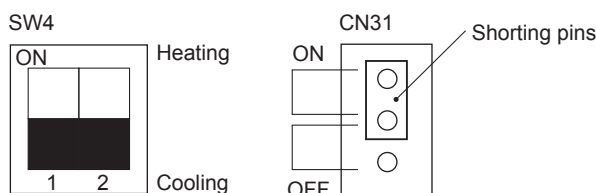

- ⑤ Turning the main power supply on will start the emergency operation.

(4) Releasing emergency operation

- ① Turn the main power supply off.
- ② Set the emergency operation switch (SWE) on indoor controller board to OFF.
- ③ Set the shorting pins of emergency operation connector (CN31) on outdoor controller board to OFF.
- ④ Set SW4-2 on outdoor controller board as shown in the right.



Note: If shorting pins are not set on emergency operation connector (CN31), the setting remains OFF.

(5) Operation data during emergency operation

During emergency operation, no communication is performed with the indoor unit, so the data items needed for operation are set to the following values:

Operation data	Operation mode		Remarks
	COOL	HEAT	
Intake temperature (TH1)	27°C	20.5°C	—
Indoor pipe temperature (TH2)	5°C	45°C	—
Indoor 2-phase pipe temperature (TH5)	5°C	50°C	—
Set temperature	25°C	22°C	—
Pressure saturation temperature (T _{63HS})	50°C	50°C	(*1)
Liquid temperature (TH3)	45°C	5°C	(*1)
Discharge pipe temperature (TH4)	80°C	80°C	(*1)
2-phase pipe temperature (TH6)	50°C	5°C	(*1)
Ambient temperature (TH7)	35°C	7°C	(*1)
Temperature difference code (intake temperature-set temperature) (Tj)	5	5	—
Discharge superheat (SHd)	30°C	30°C	(*2)
Sub-cool (SC)	5°C	5°C	(*2)

*1: If the thermistor temperature data is normal (not open/short), that data is loaded into the control as valid data.

When the unit enters emergency operation and TH values are mismatched, set the thermistors to open/short. And the unit runs emergency operation with the values listed above.

*2: If one thermistor is set to open/short, the values for each will be different from the list above.

[Example] When liquid pipe temperature thermistor (TH3) has an open or short circuit.

Thermistor	COOL	HEAT
TH3	45°C	5°C
TH6	Ta	Tb
	Regard normal figure as effective data.	
TH4	Tc	Td
	Regard normal figure as effective data.	
TH5	5°C	50°C
TH2	5°C	45°C
T _{63HS}	Te	Tf
	Regard normal figure as effective data.	

Discharge superheat (SHd)
Cooling = TH4 - T_{63HS} = Tc - Te
Heating = TH4 - T_{63HS} = Td - Tf

Degree of subcooling (SC)
Cooling = T_{63HS} - TH3 = Te - 45
Heating = T_{63HS} - TH2 = Tf - 45

10-9. TEST POINT DIAGRAM

Outdoor controller circuit board

PUHZ-SHW80VHA

PUHZ-SHW112VHA

PUHZ-SHW112YHA

PUHZ-SHW112YHAR1

PUHZ-SHW140YHA

PUHZ-SHW140YHAR1

PUHZ-SHW80VHAR2.UK

PUHZ-SHW80VHAR2-BS.UK

PUHZ-SHW112VHAR2.UK

PUHZ-SHW112VHAR2-BS.UK

PUHZ-SHW112YHAR2.UK

PUHZ-SHW112YHAR2-BS.UK

PUHZ-SHW140YHAR2.UK

PUHZ-SHW140YHAR2-BS.UK

PUHZ-SHW80VHAR3.UK

PUHZ-SHW80VHAR3-BS.UK

PUHZ-SHW112VHAR3.UK

PUHZ-SHW112VHAR3-BS.UK

PUHZ-SHW112YHAR3.UK

PUHZ-SHW112YHAR3-BS.UK

PUHZ-SHW140YHAR3.UK

PUHZ-SHW140YHAR3-BS.UK

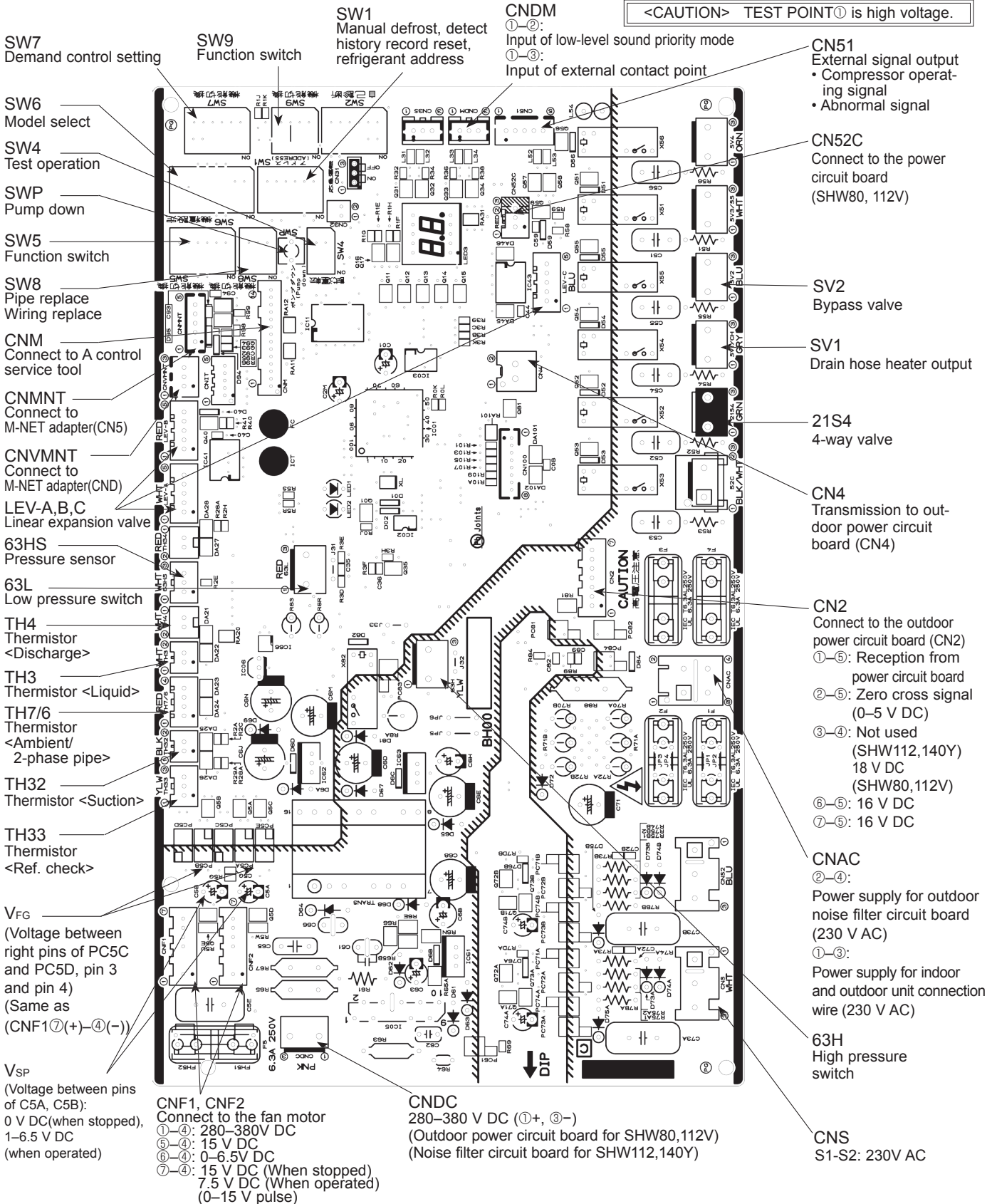

Outdoor controller circuit board

PUHZ-SHW80VHAR4.UK

PUHZ-SHW112VHAR4.UK

PUHZ-SHW140YHAR5.UK

PUHZ-SHW80VHAR4-BS.UK

PUHZ-SHW112VHAR4-BS.UK

PUHZ-SHW140YHAR5-BS.UK

PUHZ-SHW112YHAR4.UK

PUHZ-SHW140YHAR4.UK

PUHZ-SHW112YHAR4-BS.UK

PUHZ-SHW140YHAR4-BS.UK

<CAUTION> TEST POINT ① is high voltage.

CNDC
280-380 V DC Connect from outdoor power circuit board for VHA, connect from noise filter board for YHA(CNDC)

V_{DC} (TEST POINT ①)
(voltage between pins of C5E)
: 250-380 V DC

V_{CC} (TEST POINT ②)
(voltage between pins of C821): 15 V DC

V_{SP} (TEST POINT ③)
(voltage between pins of C5A, C5B): 0 V DC (when stopped), 1-6.5 V DC (when operated)

V_{FG} (TEST POINT ④)
(voltage between right pins of PC5C and PC5D, pin 3 and pin 4)

CNS
(Indoor/outdoor unit connecting wire)

63H
High pressure switch

CNAC
②-④: Power supply for outdoor controller circuit board (230 V AC)
①-③: Power supply for indoor and outdoor unit connection wire (230 V AC)

CN2
Connect to the outdoor power circuit board (CN2)
①-⑤: Power circuit board → Transmitting signal to the controller circuit board (0-5 V DC)
②-⑤: Zero cross signal (0-5V DC)
③-④: Not used. (SW75V,100/120Y) 18 V DC (SW100/120V)

⑥-⑤: 16 V DC
⑦-⑤: 16 V DC
[⑤: - ①,②,⑥,⑦: +]

21S4
4-way valve

CN4
Transmission to outdoor power circuit board (CN4)

CN52C
(Connect to the outdoor power circuit board (SHW80/112V))

CN51
External signal output
• Compressor operating signal
• Abnormal signal

CNDM
①-②: Input of low-level sound priority mode
①-③: Input of external contact point

TH6
Thermistor <2-phase pipe>
TH7
Thermistor <Ambient>

TH3
Thermistor <Liquid>
TH4
Thermistor <Discharge>
63L
Low pressure switch

63HS
High pressure sensor
TH34
Thermistor <Comp. surface>

LEV-A,-B,-C
Linear expansion valve

SW4
Test operation

SW5
Function switch, Model select

SW6
Model select

SW1
Manual defrost, detect history record reset, refrigerant address

SW7
Demand control setting

SW9
Function switch

SWP
Pump down

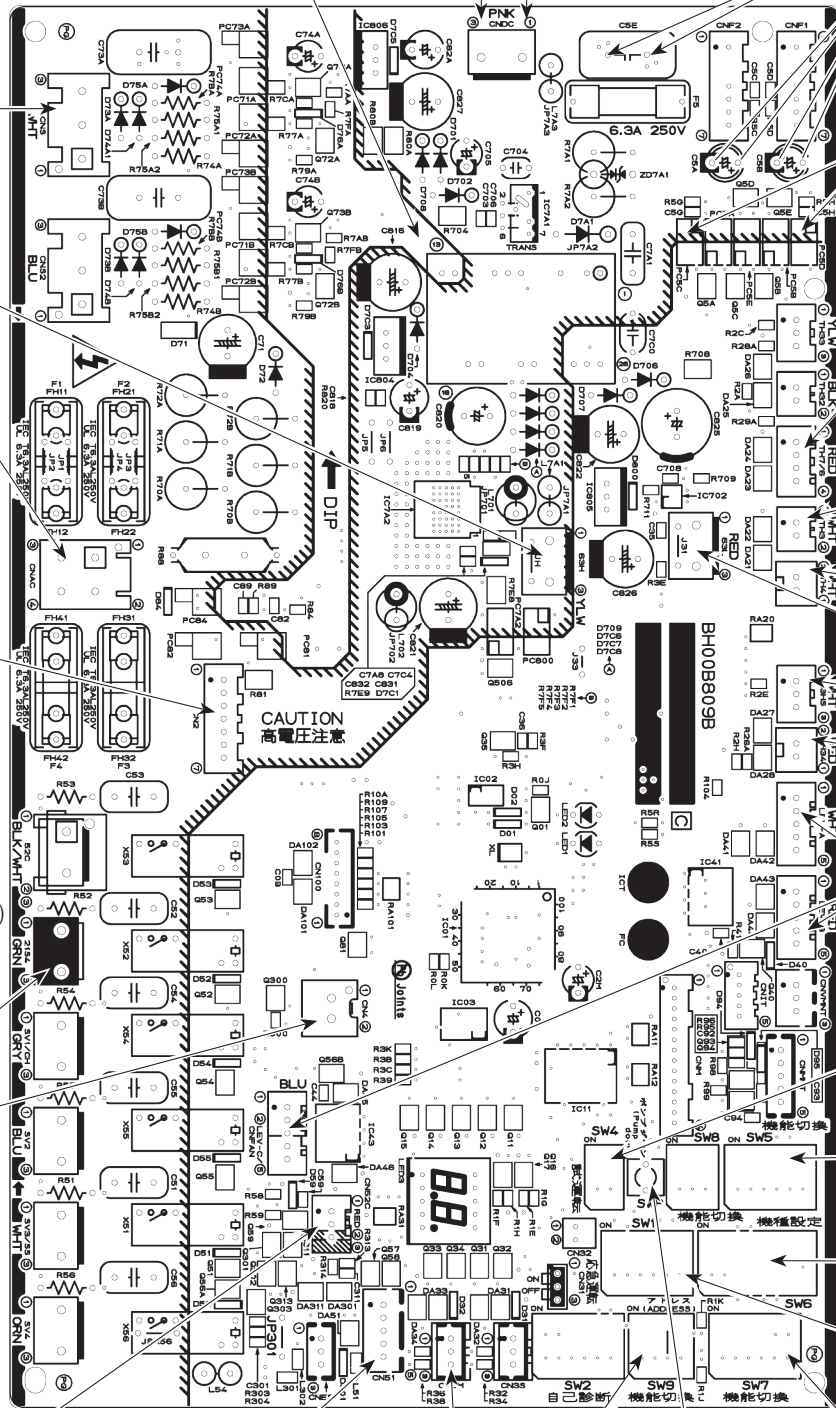

Outdoor noise filter circuit board

PUHZ-SHW112YHA

PUHZ-SHW112YHAR2-BS.UK

PUHZ-SHW140YHA

PUHZ-SHW140YHAR2-BS.UK

PUHZ-SHW112YHAR1

PUHZ-SHW112YHAR3.UK

PUHZ-SHW140YHAR1

PUHZ-SHW140YHAR3.UK

PUHZ-SHW112YHAR2.UK

PUHZ-SHW112YHAR3-BS.UK

PUHZ-SHW140YHAR2.UK

PUHZ-SHW140YHAR3-BS.UK

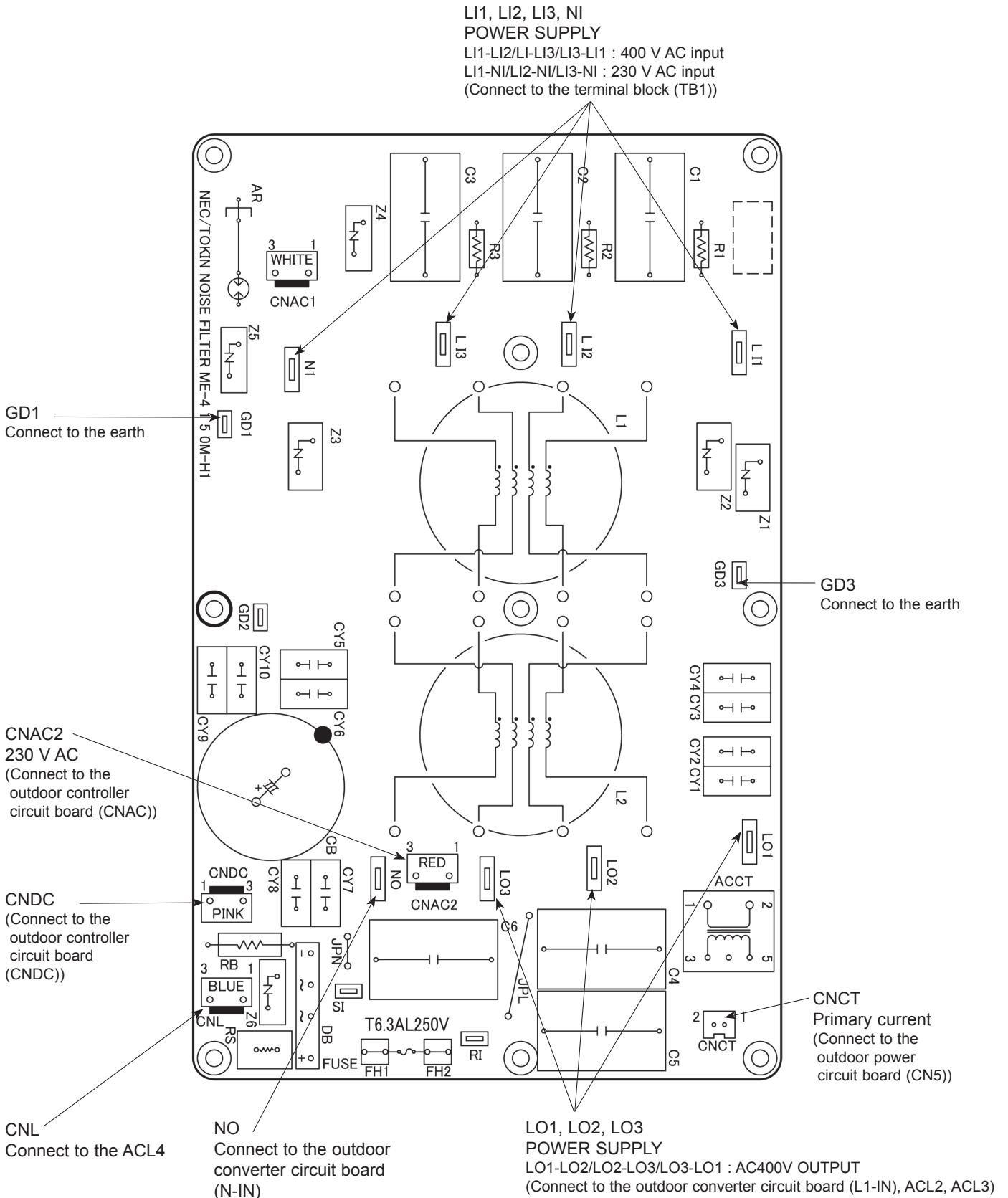

Outdoor noise filter circuit board

PUHZ-SHW112YHAR4.UK

PUHZ-SHW140YHAR4.UK

PUHZ-SHW140YHAR5.UK

PUHZ-SHW112YHAR4-BS.UK

PUHZ-SHW140YHAR4-BS.UK

PUHZ-SHW140YHAR5-BS.UK

LI1, LI2, LI3, NI
POWER SUPPLY
LI1-LI2/LI-LI3/LI3-LI1 : 400 V AC input
LI1-NI/LI2-NI/LI3-NI : 230 V AC input
(Connect to the terminal block (TB1))

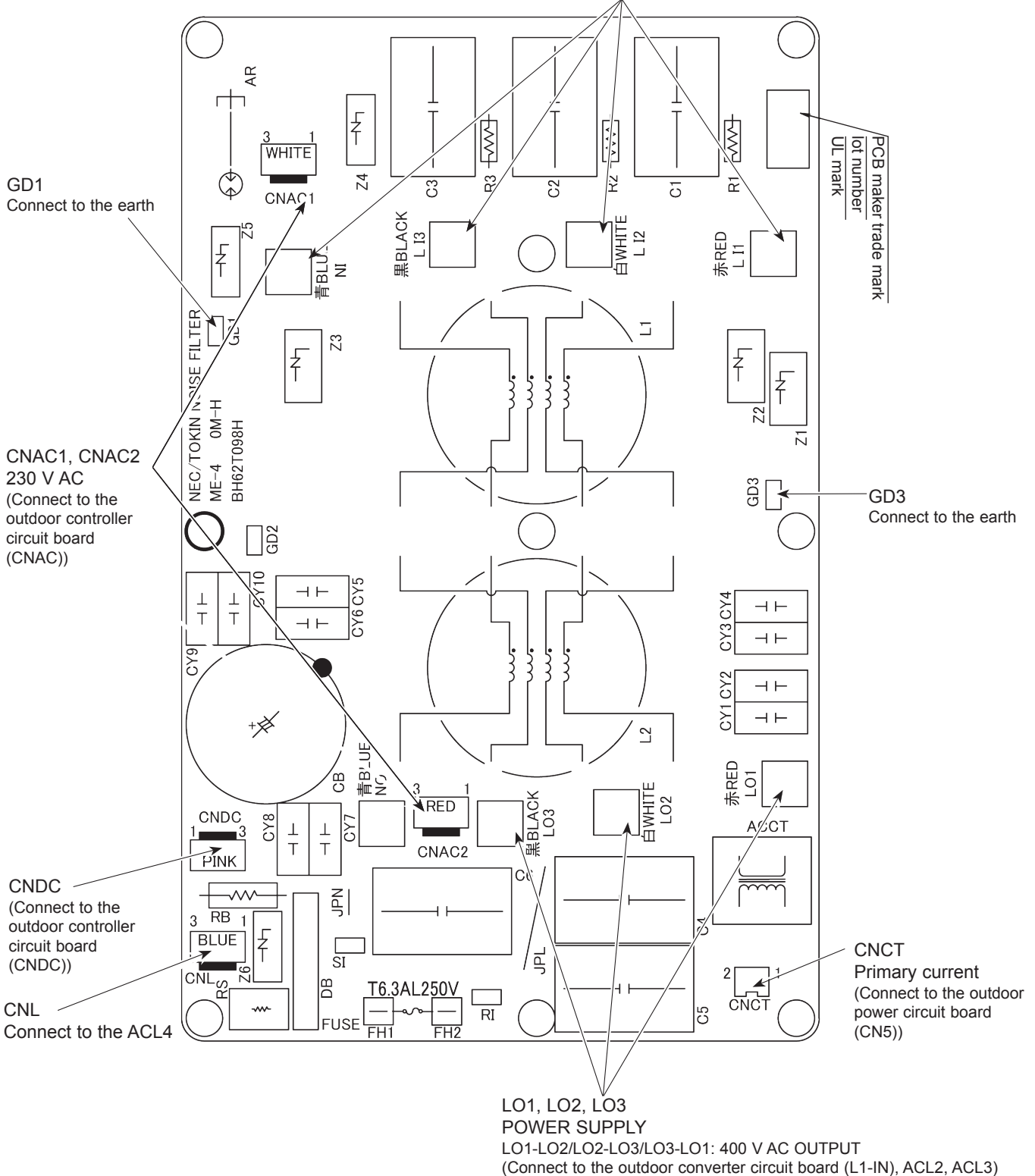

Outdoor power circuit board
PUHZ-SHW80VHA
PUHZ-SHW80VHAR2.UK
PUHZ-SHW80VHAR3.UK
PUHZ-SHW112VHA
PUHZ-SHW112VHAR2.UK
PUHZ-SHW112VHAR3.UK
PUHZ-SHW80VHAR2-BS.UK
PUHZ-SHW80VHAR3-BS.UK
PUHZ-SHW112VHAR2-BS.UK
PUHZ-SHW112VHAR3-BS.UK

Brief Check of POWER MODULE

• Usually, they are in a state of being short-circuited if they are broken. Measure the resistance in the following points (connectors, etc.). If they are short-circuited, it means that they are broken.

1. Check of POWER MODULE

① Check of DIODE circuit

R-**L1**, **S**-**L1**, **R**-**N1**, **S**-**N1**

② Check of IGBT circuit

L2-**N1**

③ Check of INVERTER circuit

P-**U**, **P**-**V**, **P**-**W**, **N1**-**U**, **N1**-**V**, **N1**-**W**

Note: The marks **R**, **S**, **L1**, **L2**, **P**, **N1**, **U**, **V** and **W** shown in the diagram are not actually printed on the board.

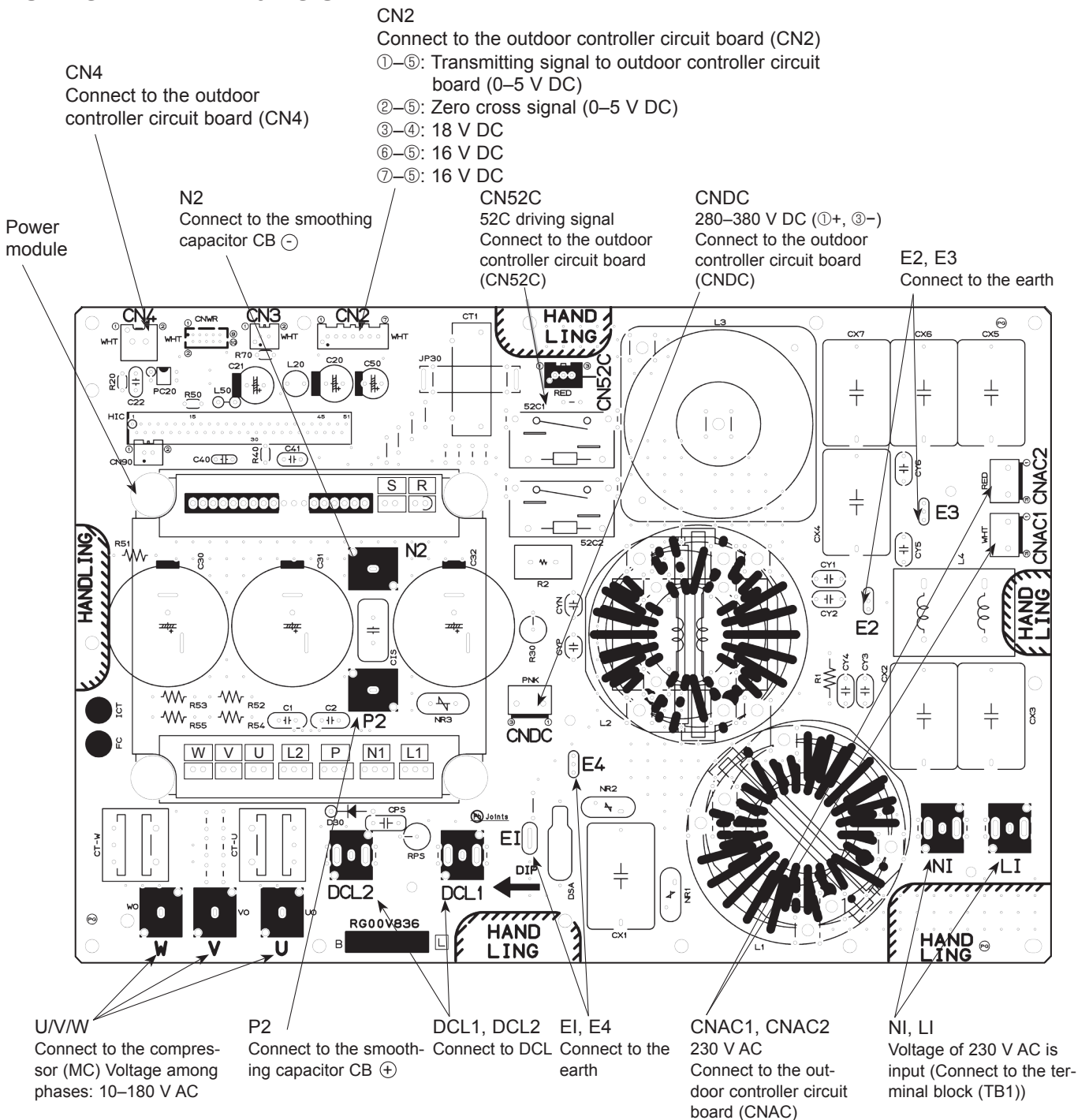

Outdoor power circuit board
PUHZ-SHW80VHAR4.UK
PUHZ-SHW112VHAR4.UK
PUHZ-SHW80VHAR4-BS.UK
PUHZ-SHW112VHAR4-BS.UK

Brief Check of POWER MODULE

Usually, they are in a state of being short-circuited if they are broken. Measure the resistance in the following points (connectors, etc.). If they are short-circuited, it means that they are broken.

1. Check of POWER MODULE

① Check of DIODE circuit

[R]-L1, [S]-L1, [R]-N1, [S]-N1

② Check of IGBT circuit

[L2]- N1

③ Check of INVERTER circuit

[P]-U, [P]-V, [P]-W, [N1]-U, [N1]-V, [N1]-W

Note: The marks **[R], [S], [L1], [L2], [P], [N1], [U], [V]** and **[W]** shown in the diagram are not actually printed on the board.

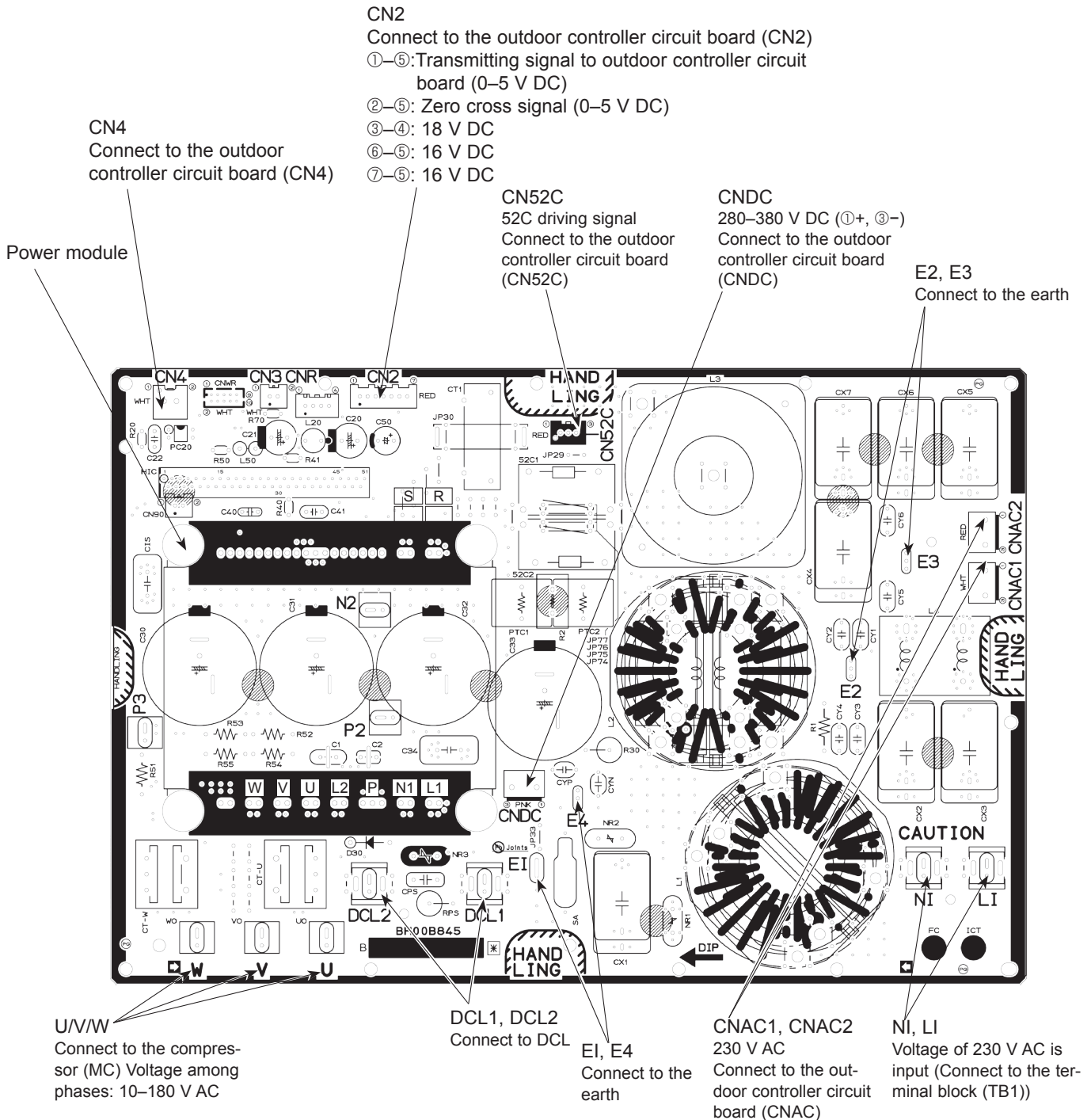

Outdoor power circuit board
PUHZ-SHW112YHA
PUHZ-SHW140YHA

Brief Check of POWER MODULE

- Usually, they are in a state of being short-circuited if they are broken. Measure the resistance in the following points (connectors, etc.). If they are short-circuited, it means that they are broken.

1. Check of DIODE MODULE
L1-P1, L2-P1, L3-P1, L1-N1, L2-N1, L3-N1
2. Check of DIP-IPM
P2-U, P2-V, P2-W, N2-U, N2-V, N2-W

Note: The marks L1, L2, L3, N1, N2, P1, P2, U, V and W shown in the diagram are not actually printed on the board.

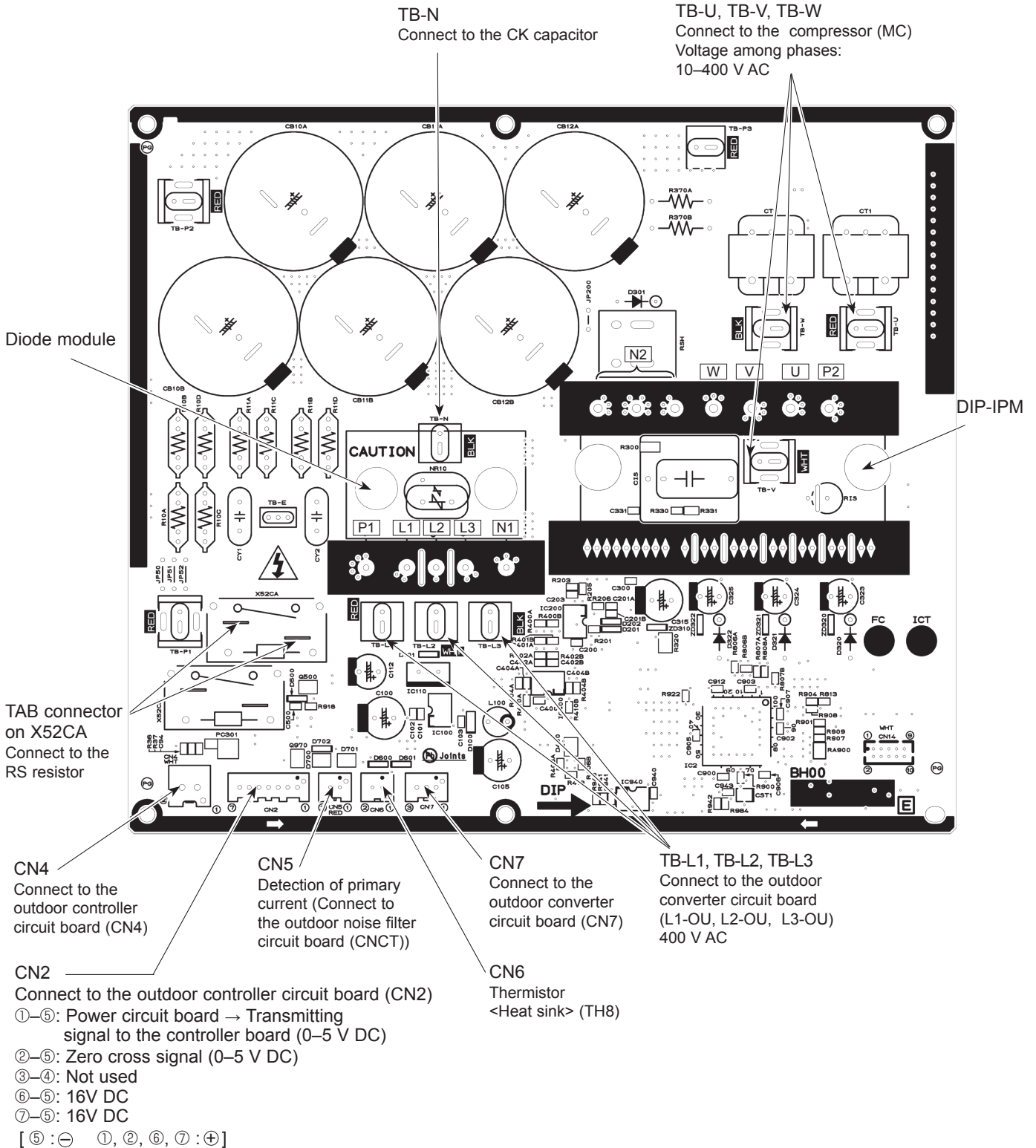

Outdoor power circuit board
 PUHZ-SHW112YHAR1
 PUHZ-SHW112YHAR2.UK
 PUHZ-SHW112YHAR3.UK
 PUHZ-SHW112YHAR4.UK
 PUHZ-SHW140YHAR1
 PUHZ-SHW140YHAR2.UK
 PUHZ-SHW140YHAR3.UK
 PUHZ-SHW140YHAR4.UK
 PUHZ-SHW140YHAR5.UK
 PUHZ-SHW112YHAR2-BS.UK
 PUHZ-SHW112YHAR3-BS.UK
 PUHZ-SHW112YHAR4-BS.UK
 PUHZ-SHW140YHAR2-BS.UK
 PUHZ-SHW140YHAR3-BS.UK
 PUHZ-SHW140YHAR4-BS.UK
 PUHZ-SHW140YHAR5-BS.UK

Brief Check of POWER MODULE

• Usually, they are in a state of being short-circuited if they are broken. Measure the resistance in the following points (connectors, etc.). If they are short-circuited, it means that they are broken.

1. Check of DIODE MODULE

L1 - P1, L2 - P1, L3 - P1, L1 - N1, L2 - N1, L3 - N1

2. Check of DIP-IPM

P2 - U, P2 - V, P2 - W, N2 - U, N2 - V, N2 - W

Note: The marks L1, L2, L3, N1, N2, P1, P2, U, V and W shown in the diagram are not actually printed on the board.

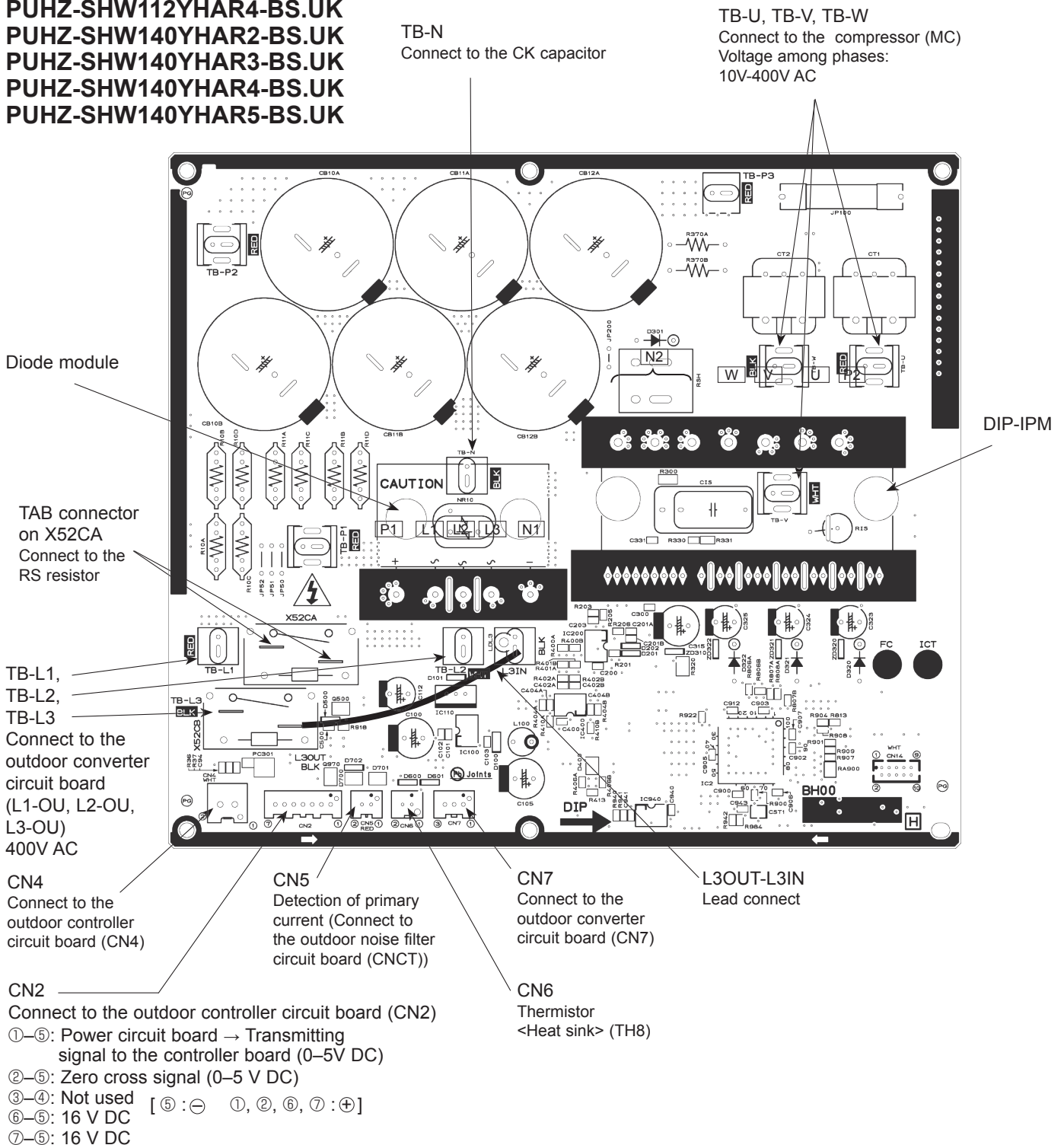

TB-N
Connect to the CK capacitor

TB-U, TB-V, TB-W
Connect to the compressor (MC)
Voltage among phases:
10V-400V AC

Diode module

TAB connector on X52CA
Connect to the RS resistor

TB-L1,
TB-L2,
TB-L3
Connect to the outdoor converter circuit board (L1-OU, L2-OU, L3-OU)
400V AC

CN4
Connect to the outdoor controller circuit board (CN4)

CN2
Connect to the outdoor controller circuit board (CN2)
 ①-⑤: Power circuit board → Transmitting signal to the controller board (0-5V DC)
 ②-⑤: Zero cross signal (0-5 V DC)
 ③-④: Not used [⑤ : ⊖ ①, ②, ⑥, ⑦ : ⊕]
 ⑥-⑤: 16 V DC
 ⑦-⑤: 16 V DC

CN5
Detection of primary current (Connect to the outdoor noise filter circuit board (CNCT))

CN7
Connect to the outdoor converter circuit board (CN7)

CN6
Thermistor <Heat sink> (TH8)

L3OUT-L3IN
Lead connect

Outdoor converter circuit board

PUHZ-SHW112YHA

PUHZ-SHW112YHAR1

PUHZ-SHW112YHAR2.UK

PUHZ-SHW112YHAR2-BS.UK

PUHZ-SHW112YHAR3.UK

PUHZ-SHW112YHAR3-BS.UK

PUHZ-SHW140YHA

PUHZ-SHW140YHAR1

PUHZ-SHW140YHAR2.UK

PUHZ-SHW140YHAR2-BS.UK

PUHZ-SHW140YHAR3.UK

PUHZ-SHW140YHAR3-BS.UK

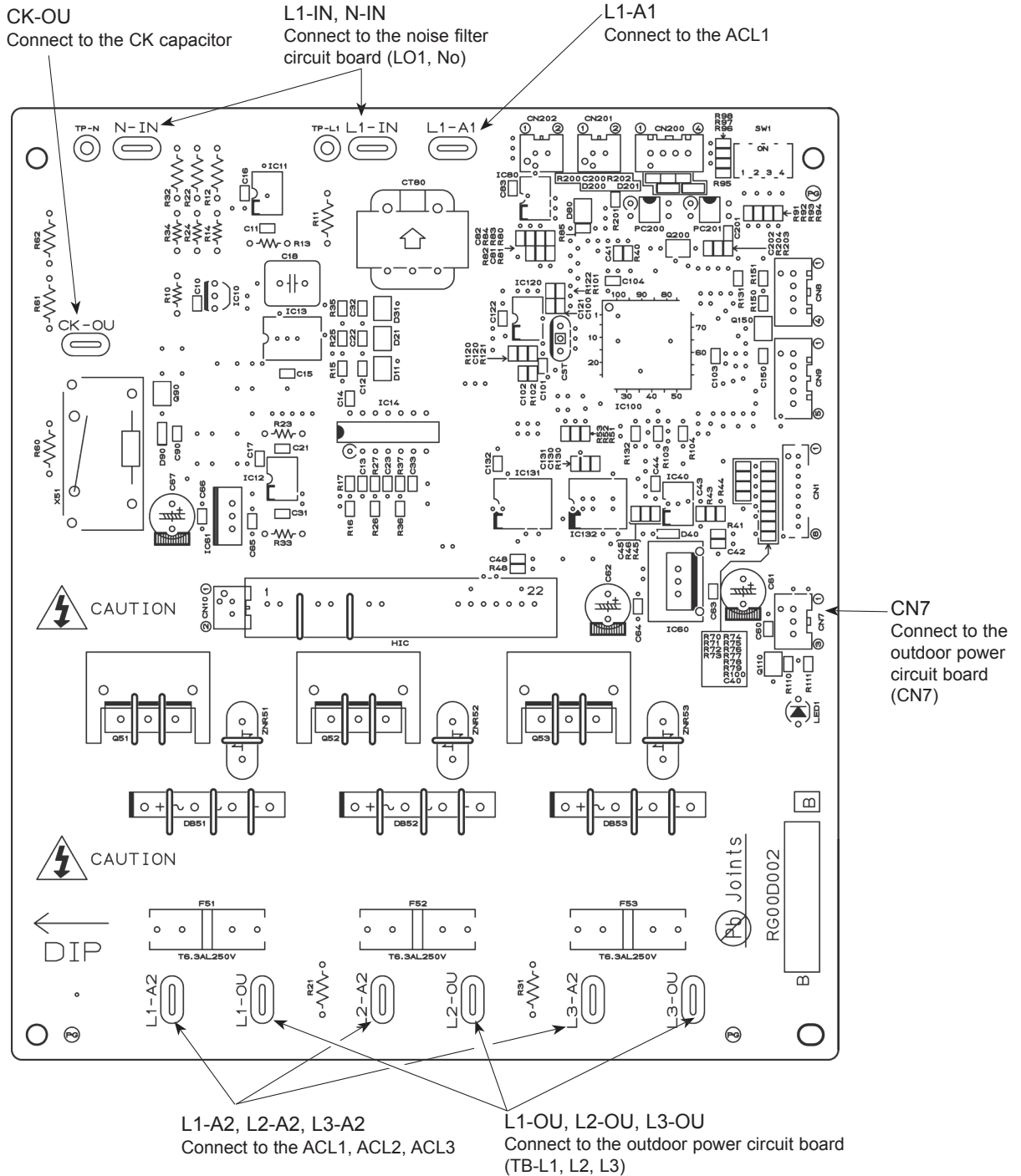

Outdoor converter circuit board

PUHZ-SHW112YHAR4.UK

PUHZ-SHW140YHAR4.UK

PUHZ-SHW140YHAR5.UK

PUHZ-SHW112YHAR4-BS.UK

PUHZ-SHW140YHAR4-BS.UK

PUHZ-SHW140YHAR5-BS.UK

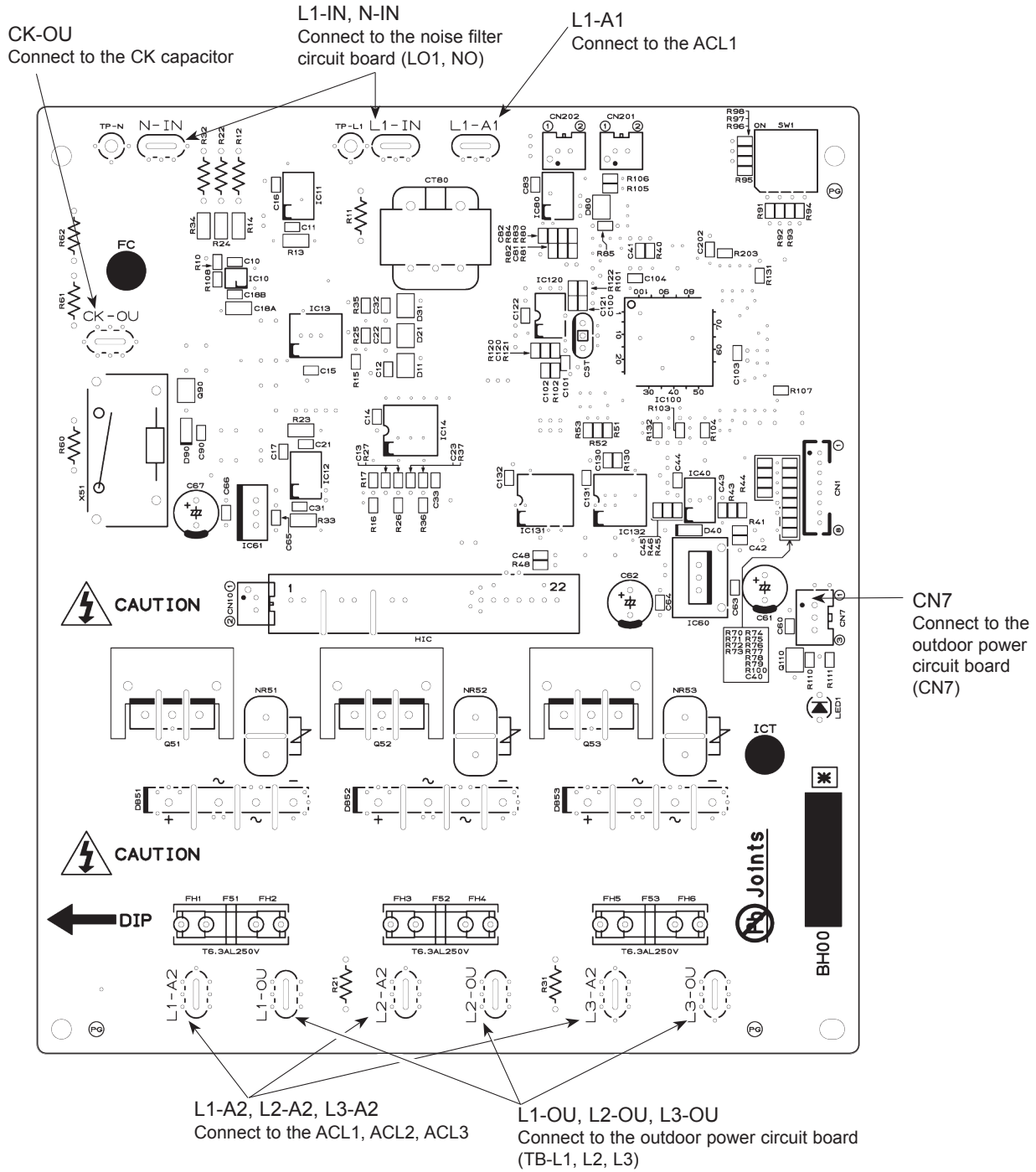

10-10. FUNCTION OF SWITCHES, CONNECTORS AND JUMPERS

(1) Function of switches

PUHZ-SHW80VHA

PUHZ-SHW80VHAR2.UK

PUHZ-SHW80VHAR3.UK

PUHZ-SHW80VHAR2-BS.UK

PUHZ-SHW80VHAR3-BS.UK

PUHZ-SHW112VHA

PUHZ-SHW112VHAR2.UK

PUHZ-SHW112VHAR3.UK

PUHZ-SHW112VHAR2-BS.UK

PUHZ-SHW112VHAR3-BS.UK

PUHZ-SHW112YHA

PUHZ-SHW112YHAR2.UK

PUHZ-SHW112YHAR3.UK

PUHZ-SHW112YHAR1

PUHZ-SHW112YHAR2-BS.UK

PUHZ-SHW112YHAR3-BS.UK

PUHZ-SHW140YHA

PUHZ-SHW140YHAR2.UK







PUHZ-SHW140YHAR3.UK

PUHZ-SHW140YHAR1

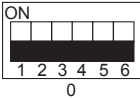
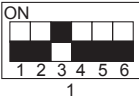
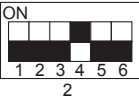
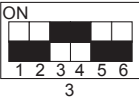
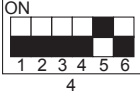
PUHZ-SHW140YHAR2-BS.UK

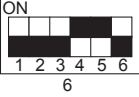
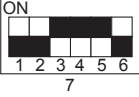
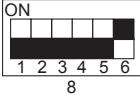
PUHZ-SHW140YHAR3-BS.UK

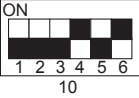
The black square (■) indicates a switch position.

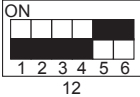
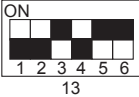
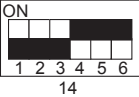
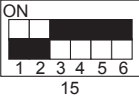
Type of switch	Switch	No.	Function	Action by the switch operation		Effective timing		
				ON	OFF			
DIP switch	SW1	1	Manual defrost *1	Start	Normal	When compressor is working in heating operation.*1		
		2	Abnormal history clear	Clear	Normal	off or operating		
		3	Refrigerant address setting *2	 0	 1	 2	 3	When power supply ON
		4		 4	 5	 6	 7	
		5		 8	 9	 10	 11	
		6		 12	 13	 14	 15	
	SW4	1		Test run	Operating	OFF	Under suspension	
		2	Test run mode setting	Heating	Cooling			
	SW8	1	Use of existing pipe	Used	Not used	Always		
		2	No function	—	—	—		
		3	Separate indoor/outdoor unit power supplies	Used	Not used	When power supply ON		
	Push switch	SWP	Pump down	Start	Normal	Under suspension		

*1 Manual defrost should be done as follows.

- ① Change the DIP SW1-1 on the outdoor controller board from OFF to ON.
- ② Manual defrost will start by the above operation ① if all these conditions written below are satisfied.
 - Heat mode setting
 - 10 minutes have passed since compressor started operating or previous manual defrost finished.
 - Pipe temperature is less than or equal to 8°C.

Manual defrost will finish if certain conditions have been satisfied.

Manual defrost can be done if above conditions have been satisfied when DIP SW1-1 is changed from OFF to ON.

After DIP SW1-1 is changed from OFF to ON, there is no problem if DIP SW1-1 is left ON or changed to OFF again. This depends on the service conditions.

*2 When the air to water system is used, up to 6 refrigerant address (0 to 5) can be assigned.

The black square (■) indicates a switch position.

Type of Switch	Switch	No.	Function	Action by the switch operation		Effective timing																
				ON	OFF																	
DIP switch	SW5	1	No function	—	—	—																
		2	Power failure automatic recovery *1	Auto recovery	No auto recovery	When power supply ON																
		3,4,5	No function	—	—	—																
		6	Model select	Following SW5-6 reference																		
	SW7 *3	1	Setting of demand control *2	<table border="1"> <thead> <tr> <th>SW7-1</th> <th>SW7-2</th> <th>Power consumption (Demand switch ON)</th> </tr> </thead> <tbody> <tr> <td>OFF</td> <td>OFF</td> <td>0% (Operation stop)</td> </tr> <tr> <td>ON</td> <td>OFF</td> <td>50%</td> </tr> <tr> <td>OFF</td> <td>ON</td> <td>75%</td> </tr> </tbody> </table>			SW7-1	SW7-2	Power consumption (Demand switch ON)	OFF	OFF	0% (Operation stop)	ON	OFF	50%	OFF	ON	75%	Always			
				SW7-1	SW7-2	Power consumption (Demand switch ON)																
				OFF	OFF	0% (Operation stop)																
		ON	OFF	50%																		
		OFF	ON	75%																		
		2																				
	3	Defrost Hz setting	Defrost Hz × 0.54	Normal	Always																	
	4	No function	—	—	—																	
	5	No function	—	—	—																	
	6	Defrost setting	For high humidity	Normal	Always																	
	SW9	1	No function	—	—	—																
							2	Function switch	Valid	Normal	Always											
		3,4	Starting Ambient temp. of flash injection	<table border="1"> <thead> <tr> <th>SW9-3</th> <th>SW9-4</th> <th>Ambient temp.</th> </tr> </thead> <tbody> <tr> <td>OFF</td> <td>OFF</td> <td>≤ 3°C (Initial setting)</td> </tr> <tr> <td>OFF</td> <td>ON</td> <td>≤ 0°C</td> </tr> <tr> <td>ON</td> <td>OFF</td> <td>≤ -3°C</td> </tr> <tr> <td>ON</td> <td>ON</td> <td>≤ -6°C</td> </tr> </tbody> </table>								SW9-3	SW9-4	Ambient temp.	OFF	OFF	≤ 3°C (Initial setting)	OFF	ON	≤ 0°C	ON	OFF
				SW9-3	SW9-4	Ambient temp.																
	OFF	OFF	≤ 3°C (Initial setting)																			
OFF	ON	≤ 0°C																				
ON	OFF	≤ -3°C																				
ON	ON	≤ -6°C																				
SW6	1-8	Model select																				
			SW5	6																		

*1 "Power failure automatic recovery" can be set by either remote controller or this DIP SW. If one of them is set to ON, "Auto recovery" activates. Please set "Auto recovery" basically by remote controller because all units do not have DIP SW. Please refer to the indoor unit installation manual.

*2 SW7-1,2 are used for demand control. SW7-1,2 are effective only at the demand control. (Refer to the next page : Special function (b))

*3 Please do not use SW7-3, 4 ,6 usually. Trouble might be caused by the usage condition.

(2) Function of connector

Types	Connector	Function	Action by open/short operation		Effective timing
			Short	Open	
Connector	CN31	Emergency operation	Start	Normal	When power supply ON

Special function

(a) Low-level sound priority mode (Local wiring)

Unit enters into Low-level sound priority mode by external signal input setting.

Inputting external signals to the outdoor unit decreases the outdoor unit operation sound 3 to 4 dB lower than that of usual.

Adding a commercial timer or on-off switch contactor setting to the CNDM connector which is optional contactor for demand input located on the outdoor controller board enables to control compressor operation frequency.

The performance depends on the load of conditioned outdoor temperature.

NOTE: When the DIP SW 9-1 on the control board of the outdoor unit is ON, set DIP SW9-1 to OFF.

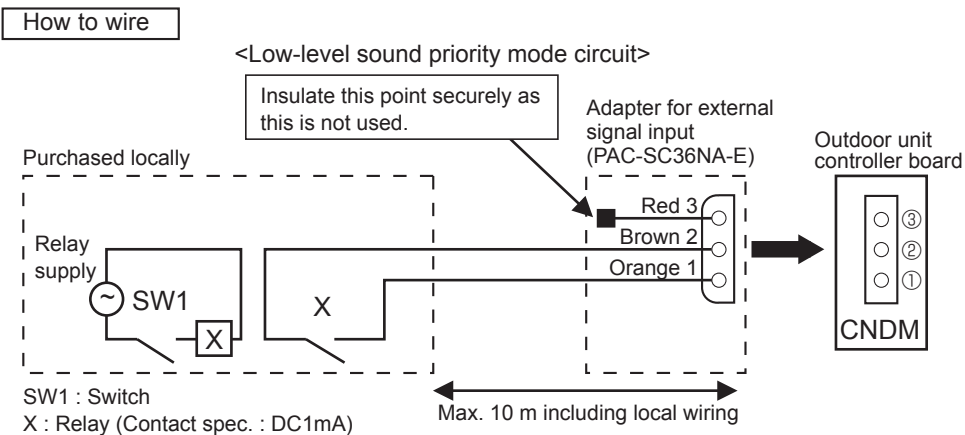

1) Make the circuit as shown above with adapter for external signal input (PAC-SC36NA-E).

2) Turn SW1 to on for Low-level sound priority mode.

Turn SW1 to off to release Low-level sound priority mode and normal operation.

(b) On demand control (Local wiring) only for air-conditioners

Demand control is available by external input. In this mode, power consumption is decreased within the range of usual 0–100%.

How to wire

Basically, the wiring is same with (a).

Connect an SW 1 which is procured locally between Orange and Red (1 and 3) of the adapter for external signal input (PAC-SC36NA-E), and insulate the tip of the brown lead wire.

It is possible to set it to the following power consumption (compared with ratings) by setting the SW7-1, 2.

SW7-1	SW7-2	Power consumption (SW1 ON)
OFF	OFF	0 % (Operation stop)
ON	OFF	50 %
OFF	ON	75 %

PUHZ-SHW80VHAR4.UK
 PUHZ-SHW80VHAR4-BS.UK
 PUHZ-SHW112YHAR4.UK
 PUHZ-SHW112YHAR4-BS.UK

PUHZ-SHW112VHAR4.UK
 PUHZ-SHW112VHAR4-BS.UK
 PUHZ-SHW140YHAR4.UK
 PUHZ-SHW140YHAR4-BS.UK

PUHZ-SHW140YHAR5.UK
 PUHZ-SHW140YHAR5-BS.UK

Type of switch	Switch	No.	Function	Action by the switch operation		Effective timing		
				ON	OFF			
DIP switch	SW1	1	Manual defrost *1	Start	Normal	When compressor is working in heating operation.*1		
		2	Abnormal history clear	Clear	Normal	off or operating		
		3	Refrigerant address setting *2					When power supply ON
		4						
		5						
		6						
	1	Test run		Operating	OFF	Under suspension		
	2	Test run mode setting	Heating	Cooling				
	SW8	1	Use of existing pipe	Used	Not used	Always		
		2	No function	—	—	—		
		3	Separate indoor/outdoor unit power supplies	Used	Not used	When power supply ON		
	Push switch	SWP		Pump down	Start	Normal	Under suspension	

*1 Manual defrost should be done as follows.

- ① Change the DIP SW1-1 on the outdoor controller board from OFF to ON.
- ② Manual defrost will start by the above operation ① if all these conditions written below are satisfied.

- Heat mode setting
- 10 minutes have passed since compressor started operating or previous manual defrost finished.
- Pipe temperature is less than or equal to 8°C.

Manual defrost will finish if certain conditions have been satisfied.

Manual defrost can be done if above conditions have been satisfied when DIP SW1-1 is changed from OFF to ON.

After DIP SW1-1 is changed from OFF to ON, there is no problem if DIP SW1-1 is left ON or changed to OFF again. This depends on the service conditions.

*2 When the air to water system is used, up to 6 refrigerant address (0 to 5) can be assigned.

The black square (■) indicates a switch position.

Type of Switch	Switch	No.	Function	Action by the switch operation		Effective timing																																																																																																											
				ON	OFF																																																																																																												
DIP switch	SW5	1	No function	—	—	—																																																																																																											
		2	Power failure automatic recovery *1	Auto recovery	No auto recovery	When power supply ON																																																																																																											
		3,4,5	No function	—	—	—																																																																																																											
		6	Model select	Following SW5-6 reference																																																																																																													
	SW7 *3	1	Mode select *2	Demand function	Low noise mode	Always																																																																																																											
		2	No function	—	—	—																																																																																																											
		3	Defrost Hz setting	Defrost Hz × 0.54	Normal	Always																																																																																																											
		4	No function	—	—	—																																																																																																											
		5	No function	—	—	—																																																																																																											
		6	Defrost setting	For high humidity	Normal	Always																																																																																																											
	SW9	1	No function	—	—	—																																																																																																											
		2	Function switch	Valid	Normal	Always																																																																																																											
		3,4	Starting Ambient temp. of flash injection	<table border="1"> <tr> <td>SW9-3</td> <td>SW9-4</td> <td>Ambient temp.</td> </tr> <tr> <td>OFF</td> <td>OFF</td> <td>≤ 3°C (Initial setting)</td> </tr> <tr> <td>OFF</td> <td>ON</td> <td>≤ 0°C</td> </tr> <tr> <td>ON</td> <td>OFF</td> <td>≤ -3°C</td> </tr> <tr> <td>ON</td> <td>ON</td> <td>≤ -6°C</td> </tr> </table>			SW9-3	SW9-4	Ambient temp.	OFF	OFF	≤ 3°C (Initial setting)	OFF	ON	≤ 0°C	ON	OFF	≤ -3°C	ON	ON	≤ -6°C	Always																																																																																											
				SW9-3	SW9-4	Ambient temp.																																																																																																											
	OFF	OFF	≤ 3°C (Initial setting)																																																																																																														
	OFF	ON	≤ 0°C																																																																																																														
	ON	OFF	≤ -3°C																																																																																																														
	ON	ON	≤ -6°C																																																																																																														
	SW6	1	Model select	<table border="1"> <tr> <td colspan="6">PUHZ-SHW-VHAR4</td> <td colspan="6">PUHZ-SHW-YHAR4/R5</td> </tr> <tr> <td>MODEL</td> <td colspan="4">SW6</td> <td colspan="2">SW5-6</td> <td>MODEL</td> <td colspan="4">SW6</td> <td colspan="2">SW5-6</td> </tr> <tr> <td>80V</td> <td>ON</td><td>OFF</td><td>■</td><td>■</td><td>■</td><td>■</td><td>■</td> <td>ON</td><td>OFF</td><td>■</td><td>■</td><td>■</td><td>■</td> <td>ON</td><td>OFF</td><td>■</td><td>■</td><td>■</td><td>■</td> </tr> <tr> <td></td> <td>1</td><td>2</td><td>3</td><td>4</td><td>5</td><td>6</td><td>7</td><td>8</td> <td>1</td><td>2</td><td>3</td><td>4</td><td>5</td><td>6</td> <td>1</td><td>2</td><td>3</td><td>4</td><td>5</td><td>6</td> </tr> <tr> <td>112V</td> <td>ON</td><td>OFF</td><td>■</td><td>■</td><td>■</td><td>■</td><td>■</td> <td>ON</td><td>OFF</td><td>■</td><td>■</td><td>■</td><td>■</td> <td>ON</td><td>OFF</td><td>■</td><td>■</td><td>■</td><td>■</td> </tr> <tr> <td></td> <td>1</td><td>2</td><td>3</td><td>4</td><td>5</td><td>6</td><td>7</td><td>8</td> <td>1</td><td>2</td><td>3</td><td>4</td><td>5</td><td>6</td> <td>1</td><td>2</td><td>3</td><td>4</td><td>5</td><td>6</td> </tr> </table>			PUHZ-SHW-VHAR4						PUHZ-SHW-YHAR4/R5						MODEL	SW6				SW5-6		MODEL	SW6				SW5-6		80V	ON	OFF	■	■	■	■	■	ON	OFF	■	■	■	■	ON	OFF	■	■	■	■		1	2	3	4	5	6	7	8	1	2	3	4	5	6	1	2	3	4	5	6	112V	ON	OFF	■	■	■	■	■	ON	OFF	■	■	■	■	ON	OFF	■	■	■	■		1	2	3	4	5	6	7	8	1	2	3	4	5	6	1	2	3	4	5
PUHZ-SHW-VHAR4							PUHZ-SHW-YHAR4/R5																																																																																																										
MODEL		SW6					SW5-6		MODEL	SW6				SW5-6																																																																																																			
80V		ON					OFF	■	■	■	■	■	ON	OFF	■	■	■	■	ON	OFF	■	■	■	■																																																																																									
		1					2	3	4	5	6	7	8	1	2	3	4	5	6	1	2	3	4	5	6																																																																																								
112V		ON					OFF	■	■	■	■	■	ON	OFF	■	■	■	■	ON	OFF	■	■	■	■																																																																																									
		1					2	3	4	5	6	7	8	1	2	3	4	5	6	1	2	3	4	5	6																																																																																								
2																																																																																																																	
3																																																																																																																	
4																																																																																																																	
5																																																																																																																	
6																																																																																																																	
7																																																																																																																	
8																																																																																																																	
SW5	6																																																																																																																

- *1 "Power failure automatic recovery" can be set by either remote controller or this DIP SW. If one of them is set to ON, "Auto recovery" activates. Please set "Auto recovery" basically by remote controller because all units do not have DIP SW. Please refer to the indoor unit installation manual.
- *2 SW7-1 is setting change over of Demand/Low noise. It is effective only in case of external input. (Local wiring is necessary. Refer to the next page: Special function.)
- *3 Please do not use SW7-3, 4, 6 usually. Trouble might be caused by the usage condition.

(2) Function of connector

Types	Connector	Function	Action by open/short operation		Effective timing
			Short	Open	
Connector	CN31	Emergency operation	Start	Normal	When power supply ON

Special function

(a) Low-level sound priority mode (Local wiring)

By performing the following modification, operation noise of the outdoor unit can be reduced by about 3-4 dB.

The low noise mode will be activated when a commercially available timer or the contact input of an ON/OFF switch is added to the CNDM connector (option) on the control board of the outdoor unit.

• The ability varies according to the outdoor temperature and conditions, etc.

- ① Complete the circuit as shown when using the external input adapter (PAC-SC36NA-E). (Option)
- ② SW7-1 (Outdoor unit control board): OFF
- ③ SW1 ON: Low noise mode
SW1 OFF: Normal operation

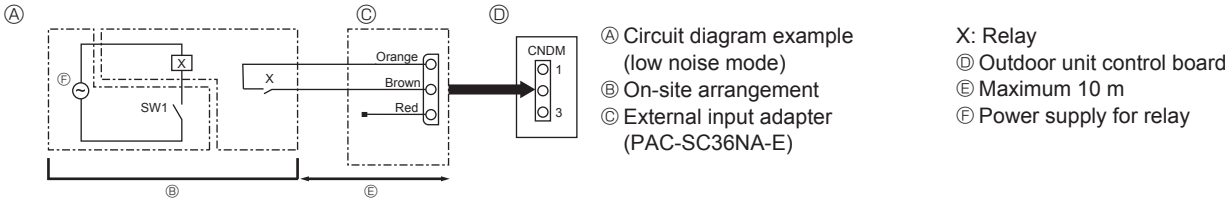

(b) On demand control (Local wiring) only for air-conditioners

By performing the following modification, energy consumption can be reduced to 0-100% of the normal consumption.

The demand function will be activated when a commercially available timer or the contact input of an ON/OFF switch is added to the CNDM connector (option) on the control board of the outdoor unit.

- ① Complete the circuit as shown when using the external input adapter (PAC-SC36NA-E). (Option)
- ② By setting SW7-1 on the control board of the outdoor unit, the energy consumption (compared to the normal consumption) can be limited as shown below.

	SW7-1	SW2	SW3	Energy consumption
Demand function	ON	OFF	OFF	100%
		ON	OFF	75%
		ON	ON	50%
		OFF	ON	0% (Stop)

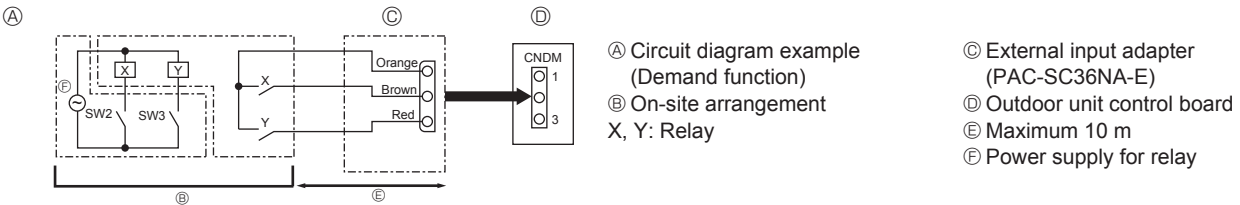

PUHZ-SHW80VHA	PUHZ-SHW80VHAR2.UK	PUHZ-SHW80VHAR3.UK	PUHZ-SHW80VHAR4.UK
	PUHZ-SHW80VHAR2-BS.UK	PUHZ-SHW80VHAR3-BS.UK	PUHZ-SHW80VHAR4-BS.UK
PUHZ-SHW112VHA	PUHZ-SHW112VHAR2.UK	PUHZ-SHW112VHAR3.UK	PUHZ-SHW112VHAR4.UK
	PUHZ-SHW112VHAR2-BS.UK	PUHZ-SHW112VHAR3-BS.UK	PUHZ-SHW112VHAR4-BS.UK
PUHZ-SHW112YHA	PUHZ-SHW112YHAR2.UK	PUHZ-SHW112YHAR3.UK	PUHZ-SHW112YHAR4.UK
PUHZ-SHW112YHAR1	PUHZ-SHW112YHAR2-BS.UK	PUHZ-SHW112YHAR3-BS.UK	PUHZ-SHW112YHAR4-BS.UK
PUHZ-SHW140YHA	PUHZ-SHW140YHAR2.UK	PUHZ-SHW140YHAR3.UK	PUHZ-SHW140YHAR4.UK
PUHZ-SHW140YHAR1	PUHZ-SHW140YHAR2-BS.UK	PUHZ-SHW140YHAR3-BS.UK	PUHZ-SHW140YHAR4-BS.UK
			PUHZ-SHW140YHAR5.UK
			PUHZ-SHW140YHAR5-BS.UK

<Display function of inspection for outdoor unit>

The blinking patterns of both LED1 (green) and LED2 (red) indicate the types of abnormality when it occurs. Types of abnormality can be indicated in details by connecting an optional part "A-Control Service Tool (PAC-SK52ST)" to connector CNM on outdoor controller board.

[Display]

(1)Normal condition

Unit condition	Outdoor controller board		A-Control Service Tool	
	LED1 (Green)	LED2 (Red)	Check code	Indication of the display
When the power is turned on	Lit	Lit	— ↔ —	Alternately blinking display
When unit stops	Lit	Not lit	00, etc.	Operation mode
When compressor is warming up	Lit	Not lit	08, etc.	
When unit operates	Lit	Lit	C5, H7, etc.	

(2)Abnormal condition

Indication		Error				
Outdoor controller board		Contents	Check code*	Inspection method	Detailed reference page	
LED1 (Green)	LED2 (Red)					
1 blinking	2 blinking	Connector(63L) is open.	F3	①Check if connector (63H or 63L) on the outdoor controller board is not disconnected. ②Check continuity of pressure switch (63H or 63L) by tester.	P.37	
		Connector(63H) is open.	F5		P.37	
		2 connectors are open.	F9		P.38	
2 blinking	1 blinking	Miswiring of indoor/outdoor unit connecting wire, excessive number of indoor units (4 units or more)	—	①Check if indoor/outdoor connecting wire is connected correctly. ②Check if 4 or more indoor units are connected to outdoor unit. ③Check if noise entered into indoor/outdoor connecting wire or power supply. ④Re-check error by turning off power, and on again.	P.38 (EA)	
		Miswiring of indoor/outdoor unit connecting wire (converse wiring or disconnection)	—		P.38 (Eb)	
		Startup time over	—		P.38 (EC)	
	2 blinking		Indoor/outdoor unit communication error (signal receiving error) is detected by indoor unit.	E6	①Check if indoor/outdoor connecting wire is connected correctly. ②Check if noise entered into indoor/outdoor connecting wire or power supply. ③Check if noise entered into indoor/outdoor controller board. ④Re-check error by turning off power, and on again.	**
			Indoor/outdoor unit communication error (transmitting error) is detected by indoor unit.	E7		**
			Indoor/outdoor unit communication error (signal receiving error) is detected by outdoor unit.	—		P.44 (E8)
			Indoor/outdoor unit communication error (transmitting error) is detected by outdoor unit.	—		P.44 (E9)
	3 blinking		Remote controller signal receiving error is detected by remote controller.	E0	①Check if connecting wire of indoor unit or remote controller is connected correctly. ②Check if noise entered into transmission wire of remote controller. ③Re-check error by turning off power, and on again.	P.43
			Remote controller transmitting error is detected by remote controller.	E3		P.44
			Remote controller signal receiving error is detected by indoor unit.	E4		P.43
			Remote controller transmitting error is detected by indoor unit.	E5		P.44
	4 blinking		Check code is not defined.	EF	①Check if remote controller is MA remote controller(PAR-21MAA). ②Check if noise entered into transmission wire of remote controller. ③Check if noise entered into indoor/outdoor connecting wire. ④Re-check error by turning off power, and on again.	P.44
PL				P.45		
5 blinking		Serial communication error <Communication between outdoor controller board and outdoor power board> <Communication between outdoor controller board and M-NET P.C. board>	Ed	①Check if connector (CN4) on outdoor controller board and outdoor power board is not disconnected. ②Check if there is poor connection of connector on outdoor controller board(CNMNT and CNVMNT). ③Check M-NET communication signal.	P.44	
			AO-A8		P.46-P.49	
		Communication error of M-NET system				

* Check code displayed on remote controller

** Refer to service manual for indoor unit.



Indication		Error			
Outdoor controller board		Contents	Check code*	Inspection method	Detailed reference page
LED1 (Green)	LED2 (Red)				
3 blinking	1 blinking	Abnormality of discharging temperature (TH4) and Comp. surface temperature (TH34)	U2	①Check if stop valves are open. ②Check if connectors (TH4, LEV-A, and LEV-B) on outdoor controller board are not disconnected. ③Check if unit is filled with specified amount of refrigerant. ④Measure resistance values among terminals on indoor valve and outdoor linear expansion valve using a tester.	P.39
		Abnormality of superheat due to low discharge temperature	U7		P.40
	2 blinking	Abnormal high pressure (High pressure switch 63H operated.)	U1	①Check if indoor/outdoor units have a short cycle on their air ducts. ②Check if connector(63H)(63L) on outdoor controller board is not disconnected. ③Check if heat exchanger and filter is not dirty. ④Measure resistance values among terminals on linear expansion valve using a tester.	P.39
		Abnormal low pressure (Low pressure switch 63L operated.)	UL		P.42
	3 blinking	Abnormality of outdoor fan motor rotational speed	U8	①Check the outdoor fan motor. ②Check if connector (TH3) (63HS) on outdoor controller board is disconnected.	P.40
		Protection from overheat operation (TH3)	Ud		P.42
	4 blinking	Compressor overcurrent breaking(Startup locked)	UF	①Check if stop valves are open. ②Check looseness, disconnection, and converse connection of compressor wiring. ③Measure resistance values among terminals on compressor using a tester. ④Check if outdoor unit has a short cycle on its air duct. ⑤Check leakage of refrigerant.	P.42
			UP		P.43
			UH		P.42
			U6		P.40
	5 blinking	Open/short of outdoor thermistors (TH4, TH34)	U3	①Check if connectors(TH3, TH32, TH33, TH4, TH34 and TH7/6) on outdoor controller board and connector (CN3) on outdoor power board are not disconnected. ②Measure resistance value of outdoor thermistors.	P.39
		Open/short of outdoor thermistors (TH3, TH32, TH33, TH6, TH7 and TH8)	U4		P.40
	6 blinking	Abnormality of heat sink temperature	U5	①Check if indoor/outdoor units have a short cycle on their air ducts. ②Measure resistance value of outdoor thermistor(TH8).	P.40
	7 blinking	Abnormality of voltage	U9	①Check looseness, disconnection, and converse connection of compressor wiring. ②Measure resistance value among terminals on compressor using a tester. ③Check if power supply voltage decreases. ④Check the wiring of CN52C. ⑤Check the wiring of CNAF.	P.41
4 blinking	1 blinking	Abnormality of room temperature thermistor (TH1)	P1	①Check if connectors (CN20, CN21, CN29 and CN44) on indoor controller board are not disconnected. ②Measure resistance value of indoor thermistors.	**
		Abnormality of pipe temperature thermistor /Liquid (TH2)	P2		**
		Abnormality of pipe temperature thermistor/Condenser-Evaporator	P9		**
	2 blinking	Abnormality of drain sensor (DS) Float switch connector open (FS)	P4	①Check if connector (CN31)(CN4F) on indoor controller board is not disconnected. ②Measure resistance value of indoor thermistors. ③Measure resistance value among terminals on drain pump using a tester. ④Check if drain pump works. ⑤Check drain function.	**
		Indoor drain overflow protection	P5		
	3 blinking	Freezing (cooling)/overheating (heating) protection	P6	①Check if indoor unit has a short cycle on its air duct. ②Check if heat exchanger and filter is not dirty. ③Measure resistance value on indoor and outdoor fan motors. ④Check if the inside of refrigerant piping is not clogged.	P.45
	4 blinking	Abnormality of pipe temperature	P8	①Check if indoor thermistors(TH2 and TH5) are not disconnected from holder. ②Check if stop valve is open. ③Check converse connection of extension pipe. (on plural units connection) ④Check if indoor/outdoor connecting wire is connected correctly. (on plural units connection)	P.45

* Check code displayed on remote controller

** Refer to service manual for indoor unit.

<Outdoor unit operation monitor function>

[When optional part "A-Control Service Tool (PAC-SK52ST)" is connected to outdoor controller board (CNM)]

Digital indicator LED1 displays 2 digit number or code to inform operation condition and the meaning of check code by controlling DIP SW2 on "A-Control Service Tool".

Operation indicator SW2 : Indicator change of self diagnosis

The black square (■) indicates a switch position.

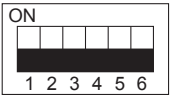
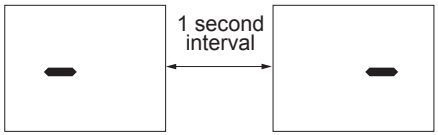
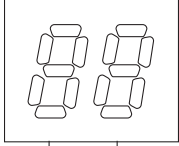
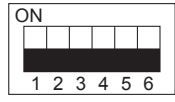
SW2 setting	Display detail	Explanation for display	Unit																																																																	
	<p><Digital indicator LED1 working details> (Be sure that 1 to 6 in the SW2 are set to OFF.)</p> <p>(1) Display when the power supply ON When the power supply ON, blinking displays by turns. Wait for 4 minutes at the longest.</p> <p>(2) When the display lights (Normal operation)</p> <p>① Operation mode display.</p>																																																																			
	 <p>(Lighting)</p>	 <p>(Initial setting)</p>																																																																		
	<p>The tens digit : Operation mode</p> <table border="1" style="width:100%; border-collapse: collapse;"> <thead> <tr> <th>Display</th> <th>Operation Model</th> </tr> </thead> <tbody> <tr><td>O</td><td>OFF / FAN</td></tr> <tr><td>C</td><td>COOLING / DRY *</td></tr> <tr><td>H</td><td>HEATING</td></tr> <tr><td>d</td><td>DEFROSTING</td></tr> </tbody> </table>	Display	Operation Model	O	OFF / FAN	C	COOLING / DRY *	H	HEATING	d	DEFROSTING	<p>The ones digit : Relay output</p> <table border="1" style="width:100%; border-collapse: collapse;"> <thead> <tr> <th>Display</th> <th>Warming-up Compressor</th> <th>Compressor</th> <th>4-way valve</th> <th>Solenoid valve</th> </tr> </thead> <tbody> <tr><td>0</td><td>—</td><td>—</td><td>—</td><td>—</td></tr> <tr><td>1</td><td>—</td><td>—</td><td>—</td><td>ON</td></tr> <tr><td>2</td><td>—</td><td>—</td><td>ON</td><td>—</td></tr> <tr><td>3</td><td>—</td><td>—</td><td>ON</td><td>ON</td></tr> <tr><td>4</td><td>—</td><td>ON</td><td>—</td><td>—</td></tr> <tr><td>5</td><td>—</td><td>ON</td><td>—</td><td>ON</td></tr> <tr><td>6</td><td>—</td><td>ON</td><td>ON</td><td>—</td></tr> <tr><td>7</td><td>—</td><td>ON</td><td>ON</td><td>ON</td></tr> <tr><td>8</td><td>ON</td><td>—</td><td>—</td><td>—</td></tr> <tr><td>A</td><td>ON</td><td>—</td><td>ON</td><td>—</td></tr> </tbody> </table>	Display	Warming-up Compressor	Compressor	4-way valve	Solenoid valve	0	—	—	—	—	1	—	—	—	ON	2	—	—	ON	—	3	—	—	ON	ON	4	—	ON	—	—	5	—	ON	—	ON	6	—	ON	ON	—	7	—	ON	ON	ON	8	ON	—	—	—	A	ON	—	ON	—	
Display	Operation Model																																																																			
O	OFF / FAN																																																																			
C	COOLING / DRY *																																																																			
H	HEATING																																																																			
d	DEFROSTING																																																																			
Display	Warming-up Compressor	Compressor	4-way valve	Solenoid valve																																																																
0	—	—	—	—																																																																
1	—	—	—	ON																																																																
2	—	—	ON	—																																																																
3	—	—	ON	ON																																																																
4	—	ON	—	—																																																																
5	—	ON	—	ON																																																																
6	—	ON	ON	—																																																																
7	—	ON	ON	ON																																																																
8	ON	—	—	—																																																																
A	ON	—	ON	—																																																																
	<p>* C5 is displayed during replacement operation.</p> <p>② Display during error postponement Postponement code is displayed when compressor stops due to the work of protection device. Postponement code is displayed while error is being postponed.</p>																																																																			
	<p>(3) When the display blinks Inspection code is displayed when compressor stops due to the work of protection devices.</p> <table border="1" style="width:100%; border-collapse: collapse;"> <thead> <tr> <th>Display</th> <th>Contents to be inspected (During operation)</th> </tr> </thead> <tbody> <tr><td>U1</td><td>Abnormal high pressure (63H operated)</td></tr> <tr><td>U2</td><td>Abnormal high discharge temperature, high comp. surface temperature, shortage of refrigerant</td></tr> <tr><td>U3</td><td>Open/short of outdoor unit thermistors (TH4, TH34)</td></tr> <tr><td>U4</td><td>Open/short of outdoor unit thermistors (TH3, TH32, TH33, TH6, TH7 and TH8)</td></tr> <tr><td>U5</td><td>Abnormal temperature of heat sink</td></tr> <tr><td>U6</td><td>Abnormality of power module</td></tr> <tr><td>U7</td><td>Abnormality of superheat due to low discharge temperature</td></tr> <tr><td>U8</td><td>Abnormality in outdoor fan motor</td></tr> <tr><td>Ud</td><td>Overheat protection</td></tr> <tr><td>UF</td><td>Compressor overcurrent interruption (When Comp. locked)</td></tr> <tr><td>UH</td><td>Current sensor error</td></tr> <tr><td>UL</td><td>Abnormal low pressure (63L operated)</td></tr> <tr><td>UP</td><td>Compressor overcurrent interruption</td></tr> <tr><td>P1–P8</td><td>Abnormality of indoor units</td></tr> <tr><td>PL</td><td>Abnormality of refrigerant</td></tr> <tr><td>A0–A7</td><td>Communication error of M-NET system</td></tr> </tbody> </table>	Display	Contents to be inspected (During operation)	U1	Abnormal high pressure (63H operated)	U2	Abnormal high discharge temperature, high comp. surface temperature, shortage of refrigerant	U3	Open/short of outdoor unit thermistors (TH4, TH34)	U4	Open/short of outdoor unit thermistors (TH3, TH32, TH33, TH6, TH7 and TH8)	U5	Abnormal temperature of heat sink	U6	Abnormality of power module	U7	Abnormality of superheat due to low discharge temperature	U8	Abnormality in outdoor fan motor	Ud	Overheat protection	UF	Compressor overcurrent interruption (When Comp. locked)	UH	Current sensor error	UL	Abnormal low pressure (63L operated)	UP	Compressor overcurrent interruption	P1–P8	Abnormality of indoor units	PL	Abnormality of refrigerant	A0–A7	Communication error of M-NET system																																	
Display	Contents to be inspected (During operation)																																																																			
U1	Abnormal high pressure (63H operated)																																																																			
U2	Abnormal high discharge temperature, high comp. surface temperature, shortage of refrigerant																																																																			
U3	Open/short of outdoor unit thermistors (TH4, TH34)																																																																			
U4	Open/short of outdoor unit thermistors (TH3, TH32, TH33, TH6, TH7 and TH8)																																																																			
U5	Abnormal temperature of heat sink																																																																			
U6	Abnormality of power module																																																																			
U7	Abnormality of superheat due to low discharge temperature																																																																			
U8	Abnormality in outdoor fan motor																																																																			
Ud	Overheat protection																																																																			
UF	Compressor overcurrent interruption (When Comp. locked)																																																																			
UH	Current sensor error																																																																			
UL	Abnormal low pressure (63L operated)																																																																			
UP	Compressor overcurrent interruption																																																																			
P1–P8	Abnormality of indoor units																																																																			
PL	Abnormality of refrigerant																																																																			
A0–A7	Communication error of M-NET system																																																																			
	<table border="1" style="width:100%; border-collapse: collapse;"> <thead> <tr> <th>Display</th> <th>Inspection unit</th> </tr> </thead> <tbody> <tr><td>0</td><td>Outdoor unit</td></tr> <tr><td>1</td><td>Indoor unit 1</td></tr> <tr><td>2</td><td>Indoor unit 2</td></tr> </tbody> </table>	Display	Inspection unit	0	Outdoor unit	1	Indoor unit 1	2	Indoor unit 2																																																											
Display	Inspection unit																																																																			
0	Outdoor unit																																																																			
1	Indoor unit 1																																																																			
2	Indoor unit 2																																																																			
	<table border="1" style="width:100%; border-collapse: collapse;"> <thead> <tr> <th>Display</th> <th>Contents to be inspected (When power is turned on)</th> </tr> </thead> <tbody> <tr><td>F3</td><td>63L connector(red) is open.</td></tr> <tr><td>F5</td><td>63H connector(yellow) is open.</td></tr> <tr><td>F9</td><td>2 connectors(63H/63L) are open.</td></tr> <tr><td>E8</td><td>Indoor/outdoor communication error (Signal receiving error) (Outdoor unit)</td></tr> <tr><td>E9</td><td>Indoor/outdoor communication error (Transmitting error) (Outdoor unit)</td></tr> <tr><td>EA</td><td>Miswiring of indoor/outdoor unit connecting wire, excessive number of indoor units (4 units or more)</td></tr> <tr><td>Eb</td><td>Miswiring of indoor/outdoor unit connecting wire(converse wiring or disconnection)</td></tr> <tr><td>EC</td><td>Startup time over</td></tr> <tr><td>E0–E7</td><td>Communication error except for outdoor unit</td></tr> </tbody> </table>	Display	Contents to be inspected (When power is turned on)	F3	63L connector(red) is open.	F5	63H connector(yellow) is open.	F9	2 connectors(63H/63L) are open.	E8	Indoor/outdoor communication error (Signal receiving error) (Outdoor unit)	E9	Indoor/outdoor communication error (Transmitting error) (Outdoor unit)	EA	Miswiring of indoor/outdoor unit connecting wire, excessive number of indoor units (4 units or more)	Eb	Miswiring of indoor/outdoor unit connecting wire(converse wiring or disconnection)	EC	Startup time over	E0–E7	Communication error except for outdoor unit																																															
Display	Contents to be inspected (When power is turned on)																																																																			
F3	63L connector(red) is open.																																																																			
F5	63H connector(yellow) is open.																																																																			
F9	2 connectors(63H/63L) are open.																																																																			
E8	Indoor/outdoor communication error (Signal receiving error) (Outdoor unit)																																																																			
E9	Indoor/outdoor communication error (Transmitting error) (Outdoor unit)																																																																			
EA	Miswiring of indoor/outdoor unit connecting wire, excessive number of indoor units (4 units or more)																																																																			
Eb	Miswiring of indoor/outdoor unit connecting wire(converse wiring or disconnection)																																																																			
EC	Startup time over																																																																			
E0–E7	Communication error except for outdoor unit																																																																			

The black square (■) indicates a switch position.

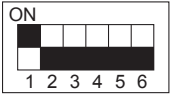
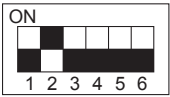
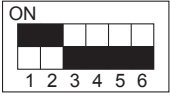
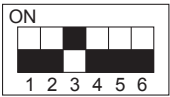
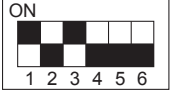
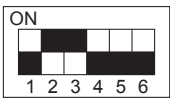
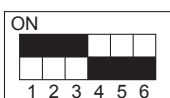
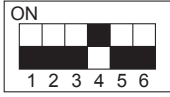
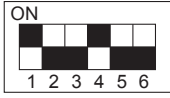
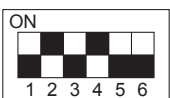
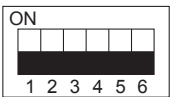
SW2 setting	Display detail	Explanation for display	Unit
	Pipe temperature/Liquid (TH3) -40 to 90	-40 to 90 (When the coil thermistor detects 0°C or below, “-” and temperature are displayed by turns.) (Example) When -10°C; 0.5 s 0.5 s 2 s -□ → 10 → □□	°C
	Discharge temperature (TH4) 3 to 217	3 to 217 (When the discharge thermistor detects 100°C or more, hundreds digit, tens digit and ones digit are displayed by turns.) (Example) When 105°C; 0.5 s 0.5 s 2 s □1 → 05 → □□	°C
	Output step of outdoor FAN 0 to 10	0 to 10	Step
	The number of ON/OFF times of compressor 0 to 9999	0 to 9999 (When the number of times is 100 or more, hundreds digit, tens digit and ones digit are displayed by turns.) (Example) When 42500 times (425 × 100 times); 0.5 s 0.5 s 2 s □4 → 25 → □□	100 times
	Compressor integrating operation times 0 to 9999	0 to 9999 (When it is 100 hours or more, hundreds digit, tens digit and ones digit are displayed by turns.) (Example) When 2450 hours (245 × 10 hours); 0.5 s 0.5 s 2 s □2 → 45 → □□	10 hours
	Compressor operating current 0 to 50	0 to 50 Note: Value after the decimal point will be truncated.	A
	Compressor operating frequency 0 to 225	0 to 255 (When it is 100 Hz or more, hundreds digit, tens digit and ones digit are displayed by turns.) (Example) When 125 Hz; 0.5 s 0.5 s 2 s □1 → 25 → □□	Hz
	LEV-A opening pulse 0 to 480	0 to 480 (When it is 100 pulse or more, hundreds digit, tens digit and ones digit are displayed by turns.) (Example) When 150 pulse; 0.5 s 0.5 s 2 s □1 → 50 → □□	Pulse
	Error postponement code history (1) of outdoor unit	Postponement code display Blinking: During postponement Lighting: Cancellation of postponement “00” is displayed in case of no postponement.	Code display
	Operation mode on error occurring	Operation mode of when operation stops due to error is displayed by setting SW2 like below. (SW2) 	Code display

The black square (■) indicates a switch position.

SW2 setting	Display detail	Explanation for display	Unit
	Pipe temperature/Liquid (TH3) on error occurring -40 to 90	-40 to 90 (When the coil thermistor detects 0°C or below, “-” and temperature are displayed by turns.) (Example) When -15°C; 0.5 s 0.5 s 2 s -□ → 15 → □□ ↑—————↓	°C
	Discharge temperature (TH4) on error occurring 3 to 217	3 to 217 (When the temperature is 100°C or more, the hundreds digit, tens digit and ones digit are displayed by turns.) (Example) When 130°C; 0.5 s 0.5 s 2 s □1 → 30 → □□ ↑—————↓	°C
	Compressor operating current on error occurring 0 to 20	0 to 20	A
	Error history (1) (latest) Alternate display of abnormal unit number and code	When no error history, “0” and “-” are displayed by turns.	Code display
	Error history (2) Alternate display of error unit number and code	When no error history, “0” and “-” are displayed by turns.	Code display
	Thermo ON time 0 to 999	0 to 999 (When it is 100 minutes or more, the hundreds digit, tens digit and ones digit are displayed by turns.) (Example) When 245 minutes; 0.5 s 0.5 s 2 s □2 → 45 → □□ ↑—————↓	Minute
	Test run elapsed time 0 to 120	0 to 120 (When it is 100 minutes or more, the hundreds digit, tens digit and ones digit are displayed by turns.) (Example) When 105 minutes; 0.5 s 0.5 s 2 s □1 → 05 → □□ ↑—————↓	Minute

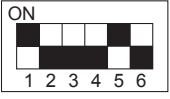
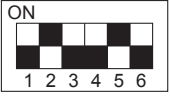
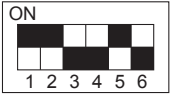
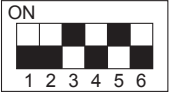
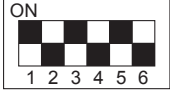
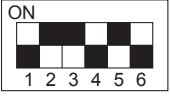
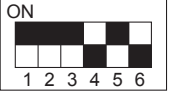
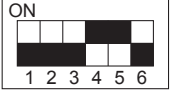

The black square (■) indicates a switch position.

SW2 setting	Display detail	Explanation for display	Unit										
	The number of connected indoor units	0 to 3 (The number of connected indoor units are displayed.)	Unit										
	Capacity setting display	Displayed as an outdoor capacity code. <table border="1" data-bbox="794 519 1066 649"> <thead> <tr> <th>Capacity</th> <th>Code</th> </tr> </thead> <tbody> <tr> <td>SHW80V</td> <td>14</td> </tr> <tr> <td>SHW112V,112Y</td> <td>20</td> </tr> <tr> <td>SHW140Y</td> <td>25</td> </tr> </tbody> </table>	Capacity	Code	SHW80V	14	SHW112V,112Y	20	SHW140Y	25	Code display		
Capacity	Code												
SHW80V	14												
SHW112V,112Y	20												
SHW140Y	25												
	Outdoor unit setting information	<ul style="list-style-type: none"> The tens digit (Total display for applied setting) <table border="1" data-bbox="753 757 1316 880"> <thead> <tr> <th>Setting details</th> <th>Display details</th> </tr> </thead> <tbody> <tr> <td>H·P / Cooling only</td> <td>0 : H·P 1 : Cooling only</td> </tr> <tr> <td>Single phase / 3 phase</td> <td>0 : Single phase 2 : 3 phase</td> </tr> </tbody> </table> <ul style="list-style-type: none"> The ones digit <table border="1" data-bbox="753 936 1316 1019"> <thead> <tr> <th>Setting details</th> <th>Display details</th> </tr> </thead> <tbody> <tr> <td>Defrosting switch</td> <td>0 : Normal 1 : For high humidity</td> </tr> </tbody> </table> <p>(Example) When heat pump, 3 phase and defrosting (normal) are set up, "20" is displayed.</p>	Setting details	Display details	H·P / Cooling only	0 : H·P 1 : Cooling only	Single phase / 3 phase	0 : Single phase 2 : 3 phase	Setting details	Display details	Defrosting switch	0 : Normal 1 : For high humidity	Code display
Setting details	Display details												
H·P / Cooling only	0 : H·P 1 : Cooling only												
Single phase / 3 phase	0 : Single phase 2 : 3 phase												
Setting details	Display details												
Defrosting switch	0 : Normal 1 : For high humidity												
	Indoor pipe temperature/Liquid (TH2(1)) Indoor 1 -39 to 88	-39 to 88 (When the temperature is 0°C or less, "-" and temperature are displayed by turns.)	°C										
	Indoor pipe temperature/Cond./Eva. (TH5(1)) Indoor 1 -39 to 88	-39 to 88 (When the temperature is 0°C or less, "-" and temperature are displayed by turns.)	°C										
	Indoor pipe temperature/Liquid (TH2(2)) Indoor 2 -39 to 88	-39 to 88 (When the temperature is 0°C or less, "-" and temperature are displayed by turns.)	°C										
	Indoor pipe temperature/Cond./Eva. (TH5(2)) Indoor 2 -39 to 88	-39 to 88 (When the temperature is 0°C or less, "-" and temperature are displayed by turns.)	°C										
	Indoor room temperature (TH1) 8 to 39	8 to 39	°C										

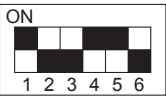
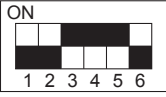
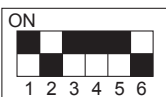
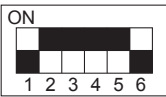
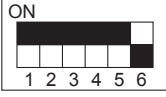
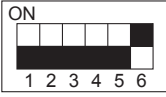
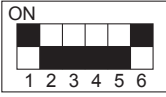
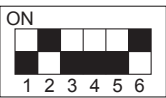
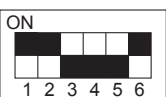
The black square (■) indicates a switch position.

SW2 setting	Display detail	Explanation for display	Unit																
	Indoor setting temperature 17 to 30	17 to 30	°C																
	Pressure saturation temperature (T _{63HS}) -39 to 88	-39 to 88 (When the temperature is 0°C or less, “-” and temperature are displayed by turns.)	°C																
	Outdoor outside temperature (TH7) -39 to 88	-39 to 88 (When the temperature is 0°C or less, “-” and temperature are displayed by turns.)	°C																
	Outdoor heat sink temperature (TH8) -40 to 200	-40 to 200 (When the temperature is 0°C or less, “-” and temperature are displayed by turns.) (When the thermistor detects 100°C or more, hundreds digit, tens digit and ones digit are displayed by turns.)	°C																
	Discharge superheat SHd 0 to 255 [Cooling = TH4-T _{63HS}] [Heating = TH4-T _{63HS}]	0 to 255 (When the temperature is 100°C or more, hundreds digit, tens digit and ones digit are displayed by turns.)	°C																
	Number of defrost cycles 0 to FFFE	0 to FFFE (in hexadecimal notation) (When more than FF in hex (255 in decimal), the number is displayed in order of 16 ³ 's and 16 ² 's, and 16 ¹ 's and 16 ⁰ 's places. (Example) When 5000 cycles; 0.5 s 0.5 s 2 s □9 → C4 → □□	2 cycles																
	Input current of outdoor unit	0 to 500 (When it is 100 or more, hundreds digit, tens digit and ones digit are displayed by turns.)	0.1 A																
	LEV-B opening pulse 0 to 480	0 to 480 (When it is 100 pulse or more, hundreds digit, tens digit and ones digit are displayed by turns.)	Pulse																
	U9 error detail history (latest)	<table border="1" data-bbox="836 1688 1385 1924"> <thead> <tr> <th>Description</th> <th>Display</th> </tr> </thead> <tbody> <tr> <td>Normal</td> <td>00</td> </tr> <tr> <td>Oversvoltage error</td> <td>01</td> </tr> <tr> <td>Undersvoltage error</td> <td>02</td> </tr> <tr> <td>Input current sensor error</td> <td rowspan="2">04</td> </tr> <tr> <td>L₁-phase open error</td> </tr> <tr> <td>Abnormal power synchronous signal</td> <td>08</td> </tr> <tr> <td>PFC/IGBT error (SHW80, 112V)</td> <td rowspan="2">20</td> </tr> <tr> <td>Undersvoltage</td> </tr> </tbody> </table> <p>• Display examples for multiple errors: Oversvoltage (01) + Undersvoltage (02) = 03 Undersvoltage (02) + Power-sync signal error (08) = 0A L₁ phase open error (04) + PFC/IGBT error (20) = 24</p>	Description	Display	Normal	00	Oversvoltage error	01	Undersvoltage error	02	Input current sensor error	04	L ₁ -phase open error	Abnormal power synchronous signal	08	PFC/IGBT error (SHW80, 112V)	20	Undersvoltage	Code display
Description	Display																		
Normal	00																		
Oversvoltage error	01																		
Undersvoltage error	02																		
Input current sensor error	04																		
L ₁ -phase open error																			
Abnormal power synchronous signal	08																		
PFC/IGBT error (SHW80, 112V)	20																		
Undersvoltage																			

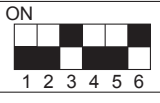
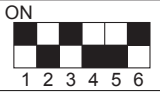
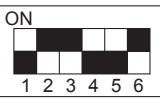
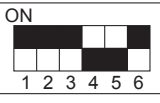
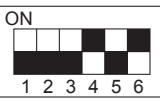
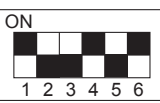
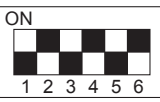
The black square (■) indicates a switch position.

SW2 setting	Display detail	Explanation for display	Unit
	DC bus voltage 180 to 370	180 to 370 (When it is 100 V or more, hundreds digit, tens digit and ones digit are displayed by turns.)	V
	Capacity save 0 to 255 When air conditioner is connected to M-NET and capacity save mode is demanded, "0" to "100" is displayed. [When there is no setting of capacity save "100" is displayed.]	0 to 255 (When the capacity is 100%, hundreds digit, tens digit and ones digit are displayed by turns.) (Example) When 100%; 0.5 s 0.5 s 2 s □1 →00 →□□	%
	Error postponement code history (2) of outdoor unit	Postponement code display Blinking: During postponement Lighting: Cancellation of postponement "00" is displayed in case of no postponement.	Code display
	Error postponement code history (3) of outdoor unit	Postponement code display Blinking: During postponement Lighting: Cancellation of postponement "00" is displayed in case of no postponement.	Code display
	Error history (3) (Oldest) Alternate display of abnormal unit number and code	When no error history, "0" and "--" are displayed by turns.	Code display
	Error thermistor display [When there is no error thermistor, "--" is displayed.]	3: Liquid pipe temperature (TH3) 4: Discharge pipe temperature (TH4) 6: 2-phase pipe temperature (TH6) 7: Ambient temperature (TH7) 8: Heat sink temperature (TH8) 32: Suction pipe temperature (TH32) 34: Comp. surface temperature (TH34)	Code display
	Operation frequency on error occurring 0 to 255	0 to 255 (When it is 100 Hz or more, hundreds digit, tens digit and ones digit are displayed by turns.) (Example) When 125 Hz; 0.5 s 0.5 s 2 s □1 →25 →□□	Hz
	Fan step on error occurring 0 to 10	0 to 10	Step

The black square (■) indicates a switch position.

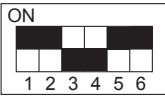
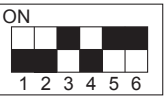
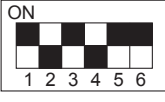
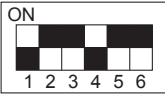
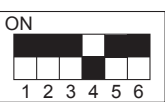
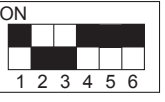
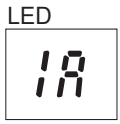
SW2 setting	Display detail	Explanation for display	Unit																
	Discharge superheat on error occurring SHd 0 to 255 [Cooling = TH4-T _{63HS}] [Heating = TH4-T _{63HS}]	0 to 255 (When the temperature is 100°C or more, hundreds digit, tens digit and ones digit are displayed by turns.) (Example) When 150°C; 0.5 s 0.5 s 2 s □1 → 50 → □□ ↑	°C																
	Sub cool on error occurring SC 0 to 130 [Cooling = T _{63HS} -TH3] [Heating = T _{63HS} -TH2]	0 to 130 (When the temperature is 100°C or more, hundreds digit, tens digit and ones digit are displayed by turns.) (Example) When 115°C; 0.5 s 0.5 s 2 s □1 → 15 → □□ ↑	°C																
	Thermo-on time until error stops 0 to 999	0 to 999 (When it is 100 minutes or more, hundreds digit, tens digit and ones digit are displayed by turns.) (Example) When 415 minutes; 0.5 s 0.5 s 2 s □4 → 15 → □□ ↑	Minute																
	Indoor pipe temperature/Liquid (TH2 (3)) Indoor 3 -39 to 88	-39 to 88 (When the temperature is 0°C or less, “-” and temperature are displayed by turns.)	°C																
	Indoor pipe temperature/Cond./Eva. (TH5 (3)) Indoor 3 -39 to 88	-39 to 88 (When the temperature is 0°C or less, “-” and temperature are displayed by turns.) When there is no indoor unit, “00” is displayed.	°C																
	Controlling status of compressor operating frequency	The following code will be a help to know the operating status of unit. •The tens digit <table border="1" data-bbox="774 1500 1220 1601"> <thead> <tr> <th>Display</th> <th>Compressor operating frequency control</th> </tr> </thead> <tbody> <tr> <td>1</td> <td>Primary current control</td> </tr> <tr> <td>2</td> <td>Secondary current control</td> </tr> </tbody> </table> •The ones digit (In this digit, the total number of activated control is displayed.) <table border="1" data-bbox="774 1668 1220 1915"> <thead> <tr> <th>Display</th> <th>Compressor operating frequency control</th> </tr> </thead> <tbody> <tr> <td>1</td> <td>Preventive control for excessive temperature rise of discharge temperature</td> </tr> <tr> <td>2</td> <td>Preventive control for excessive temperature rise of condensing temperature</td> </tr> <tr> <td>4</td> <td>Frosting preventing control</td> </tr> <tr> <td>8</td> <td>Preventive control for excessive temperature rise of radiator panel</td> </tr> </tbody> </table> (Example) The following controls are activated. • Primary current control • Preventive control for excessive temperature rise of condensing temperature • Preventive control for excessive temperature rise of heat sink <div style="text-align: right;"> LED  </div>	Display	Compressor operating frequency control	1	Primary current control	2	Secondary current control	Display	Compressor operating frequency control	1	Preventive control for excessive temperature rise of discharge temperature	2	Preventive control for excessive temperature rise of condensing temperature	4	Frosting preventing control	8	Preventive control for excessive temperature rise of radiator panel	Code display
Display	Compressor operating frequency control																		
1	Primary current control																		
2	Secondary current control																		
Display	Compressor operating frequency control																		
1	Preventive control for excessive temperature rise of discharge temperature																		
2	Preventive control for excessive temperature rise of condensing temperature																		
4	Frosting preventing control																		
8	Preventive control for excessive temperature rise of radiator panel																		

The black square (■) indicates a switch position.

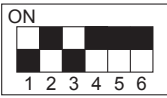
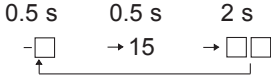
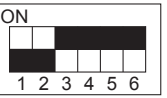
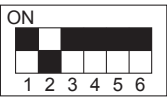
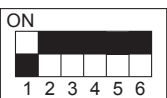
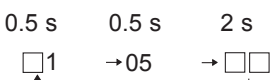
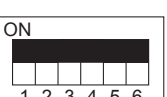
SW2 setting	Display detail	Explanation for display	Unit																		
	Outdoor suction pipe temperature (TH32) -39 to 88	-39 to 88 (When the temperature is 0°C or less, “-” and temperature are displayed by turns.) (Example) When -15°C; 0.5 s 0.5 s 2 s -□ → 15 → □□ 	°C																		
	LEV-C opening pulse 0 to 480	0 to 480 (When it is 100 pulse or more, hundreds digit, tens digit and ones digit are displayed by turns.)	Pulse																		
	Outdoor pipe temperature (TH33) -39 to 88	-39 to 88 (When the temperature is 0°C or less, “-” and temperature are displayed by turns.)	°C																		
	Comp. surface thermistor (TH34) -52 to 221	-52 to 221 (When the temperature is 0°C or less, “-” and temperature are displayed by turns.) (When the discharge thermistor detects 100°C or more, hundreds digit, tens digit and ones digit are displayed by turns.) (Example) When 105°C; 0.5 s 0.5 s 2 s □1 → 05 → □□ 	°C																		
	U9 error details (To be shown while error call is deferred.)	<table border="1" data-bbox="826 1193 1377 1429"> <thead> <tr> <th>Description</th> <th>Display</th> </tr> </thead> <tbody> <tr> <td>Normal</td> <td>00</td> </tr> <tr> <td>Overvoltage error</td> <td>01</td> </tr> <tr> <td>Undervoltage error</td> <td>02</td> </tr> <tr> <td>Input current sensor error</td> <td></td> </tr> <tr> <td>L₁-phase open error</td> <td>04</td> </tr> <tr> <td>Abnormal power synchronous signal</td> <td>08</td> </tr> <tr> <td>PFC/IGBT error (SHW80, 112V)</td> <td></td> </tr> <tr> <td>Undervoltage</td> <td>20</td> </tr> </tbody> </table> <p>• Display examples for multiple errors: Overvoltage (01) + Undervoltage (02) = 03 Undervoltage (02) + Power-sync signal error (08) = 0A L₁ phase open error (04) + PFC/IGBT error (20) = 24</p>	Description	Display	Normal	00	Overvoltage error	01	Undervoltage error	02	Input current sensor error		L ₁ -phase open error	04	Abnormal power synchronous signal	08	PFC/IGBT error (SHW80, 112V)		Undervoltage	20	Code display
Description	Display																				
Normal	00																				
Overvoltage error	01																				
Undervoltage error	02																				
Input current sensor error																					
L ₁ -phase open error	04																				
Abnormal power synchronous signal	08																				
PFC/IGBT error (SHW80, 112V)																					
Undervoltage	20																				

11-1. UNIT FUNCTION SETTING BY THE REMOTE CONTROLLER

Each function can be set as necessary using the remote controller. The setting of function for each unit can only be done by the remote controller. Select function available from the table 1.

<Table 1> Function selections

(1) Functions are available when setting the unit number to 00 (Select 00 referring to ④ setting the indoor unit number.)

Function	Settings	Mode No.	Setting No.	● : Initial setting (when sent from the factory)	Remarks
Power failure automatic recovery	OFF	01	1		The setting is applied to all the units in the same refrigerant system.
	ON		2	●	
Indoor temperature detecting *	Average data from each indoor unit	02	1	●	
	Data from the indoor unit with remote controller		2		
	Data from main remote controller		3		
LOSSNAY connectivity	Not supported	03	1	●	
	Supported (Indoor unit does not intake outdoor air through LOSSNAY)		2		
	Supported (Indoor unit intakes outdoor air through LOSSNAY)		3		
Power supply voltage	240V	04	1		
	220V, 230V		2	●	
Frost prevention temperature	2°C (Normal)	15	1	●	
	3°C		2		
Humidifier control (Heating mode)	When the compressor operates, the humidifier also operates.	16	1	●	
	When the fan operates, the humidifier also operates.		2		
Change of defrosting control	Standard	17	1	●	
	For high humidity		2		
Refrigerant leakage setting (%)	80%	21	1	●	
	60%		2		

* The function is available only when the wired remote controller is used. The function is not available for floor standing models.

Meaning of "Function setting"

Mode02:indoor temperature detecting

No.	Indoor temperature(ta)=		Diagram 1	Diagram 2	Diagram 3	Diagram 4
No.1	Average data of the sensor on all the indoor units	Initial setting	$ta=(A+B)/2$	$ta=(A+B)/2$	$ta=A$	$ta=A$
No.2	Data of the sensor on the indoor unit that connected with remote controller		$ta=A$	$ta=B$	$ta=A$	$ta=A$
No.3	Data of the sensor on main remote controller		$ta=C$	$ta=C$	$ta=C$	$ta=C$

- (2) Functions are available when setting the unit number to 01-03 or AL (07 in case of wireless remote controller)
- When setting functions for an indoor unit in an independent system, set the unit number to 01 referring to ④ Set the indoor unit number of Operating Procedure.
 - When setting functions for a simultaneous twin indoor unit system, set the unit number to 01 to 02 for each indoor unit in case of selecting different functions for each unit referring to ④ setting the indoor unit number of Operating Procedure.
 - When setting the same functions for an entire simultaneous twin indoor unit system, set refrigerant address to AL (07 in case of wireless remote controller) referring to ④ setting the indoor unit number of Operating Procedure.

Function	Settings	Mode No.	Setting No.	● : Initial setting (Factory setting) - : Not available				
				4-Way cassette	Ceiling concealed	Wall mounted		
				PLA-BA(2)(3)	PEAD-JA(Q)	PKA-FAL(2)	PKA-HAL	PKA-KAL
Filter sign	100h	07	1			●	●	●
	2500h		2	●				
	No filter sign indicator		3		●			
Air flow (Fan speed)	Quiet	08	1		Refer to the <table 1> below.	-	-	
	Standard		2	●		-	●	●
	High ceiling		3			-	-	-
No. of air outlets	4 directions	09	1	●	-	-	-	-
	3 directions		2		-	-	-	-
	2 directions		3		-	-	-	-
Optional high efficiency filter	Not supported	10	1	●	Refer to the <table 1> below.	-	-	-
	Supported		2			-	-	-
Vane setting	No vanes (Vane No.3 setting : PLA only)	11	1		-	-	-	-
	Vane No.1 setting		2		-	-	-	-
	Vane No.2 setting		3	●	-	-	-	-
Optional humidifier (PLA only)	Not supported	13	1	●	-	-	-	-
	Supported		2		-	-	-	-
Vane differential setting in heating mode (cold wind prevention)	No.1 setting (TH5: 24-28°C)	14	1		-	-	-	-
	No.2 setting (Standard, TH5:28-32°C)		2	●	-	●	●	●
	No.3 setting (TH5: 32-38°C)		3		-	-	-	-
Swing	Not available : Swing } PLA	23	1		-	-	-	-
	Available : Wave air flow }		2	●	-	●	●	●
Set temperature in heating mode (4 degrees up) *	Available : Temperature correction: Valid } PLA	24	1	●	●	●	●	●
	Not available : Temperature correction: Invalid }		2		-	-	-	-
Fan speed when the heating thermostat is OFF	Extra low	25	1	●	●	●	●	●
	Stop		2		-	-	-	-
	Set fan speed		3		-	-	-	-
Fan speed when the cooling thermostat is OFF	Set fan speed	27	1	●	●	●	●	●
	Stop		2		-	-	-	-
Detection of abnormality of the pipe temperature (P8)	Available	28	1	●	●	●	●	●
	Not available		2		-	-	-	-

* PKA-FAL/HAL/KAL : 2 degrees up

Mode No.11

Setting No.	Settings	PLA-BA(2)(3)
1	Vane No.3 setting No Vanes	Less smudging (Downward position than the standard)
2	Vane No.1 setting	Standard
3	Vane No.2 setting	Less draft * (Upward position than the standard)

* Be careful of the smudge on ceiling.

<Table 1>

External static pressure	Setting No.		Initial setting (Factory setting)
	Mode No. 08	Mode No. 10	
35Pa	2	1	
50Pa	3	1	●
70Pa	1	2	
100Pa	2	2	
150Pa	3	2	

11-1-1. Selecting functions using the wired remote controller <PAR-3xMAA ("x" represents 0 or later)>

<Service menu>

Maintenance password is required

① Select "Service" from the Main menu, and press the button.

Note: At the main display, the menu button and select "Service" to make the maintenance setting.

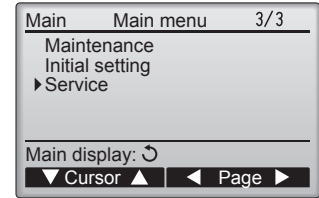

② When the Service menu is selected, a window will appear asking for the password.

To enter the current maintenance password (4 numerical digits), move the cursor to the digit you want to change with the **[F1]** or **[F2]** button.



Set each number (0 through 9) with the **[F3]** or **[F4]** button.



Then, press the button.

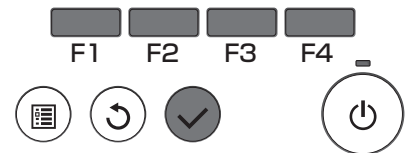
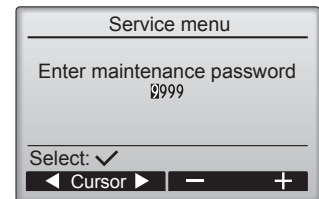

Note: The initial maintenance password is "9999". Change the default password as necessary to prevent unauthorized access. Have the password available for those who need it.

: If you forget your maintenance password, you can initialize the password to the default password "9999" by pressing and holding the **[F1] and **[F2]** buttons simultaneously for three seconds on the maintenance password setting screen.**

③ If the password matches, the Service menu will appear.

The type of menu that appears depends on the connected indoor unit type.

Note: Air conditioning units may need to be stopped to make certain settings. There may be some settings that cannot be made when the system is centrally controlled.



A screen will appear that indicates the setting has been saved.

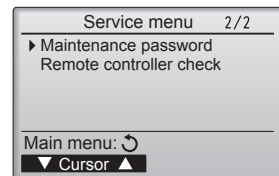
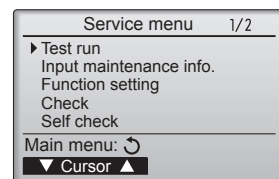

Navigating through the screens

- To go back to the Main menu button
- To return to the previous screen..... button

<Function setting>

- ① Select "Service" from the Main menu, and press the  button.



Select "Function setting" with the **[F1]** or **[F2]** button, and press the  button.

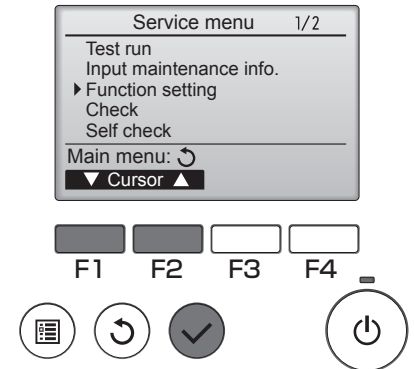

- ② Set the indoor unit refrigerant addresses and unit numbers with the **[F1]** through **[F4]** buttons, and then press the  button to confirm the current setting.

<Checking the indoor unit No.>

When the  button is pressed, the target indoor unit will start fan operation. If the unit is common or when running all units, all indoor units for the selected refrigerant address will start fan operation.

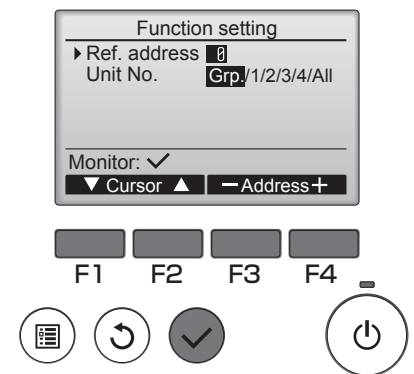

- ③ When data collection from the indoor units is completed, the current settings appears highlighted. Non-highlighted items indicate that no function settings are made. Screen appearance varies depending on the "Unit No." setting.

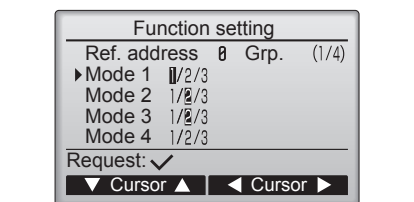

- ④ Use the **[F1]** or **[F2]** button to move the cursor to select the mode number, and change the setting number with the **[F3]** or **[F4]** button.

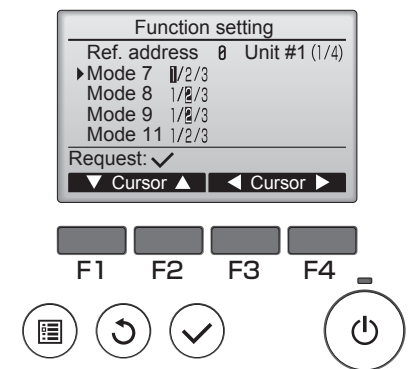

- ⑤ When the settings are completed, press the  button to send the setting data from the remote controller to the indoor units. When the transmission is successfully completed, the screen will return to the Function setting screen.

Note: • Make the above settings only on Mr. Slim units as necessary.

- The above function settings are not available for the City Multi units.
- Table 1 summarizes the setting options for each mode number. Refer to the indoor unit Installation Manual for the detailed information about initial settings, mode numbers, and setting numbers for the indoor units.
- Be sure to write down the settings for all functions if any of the initial settings has been changed after the completion of installation work.

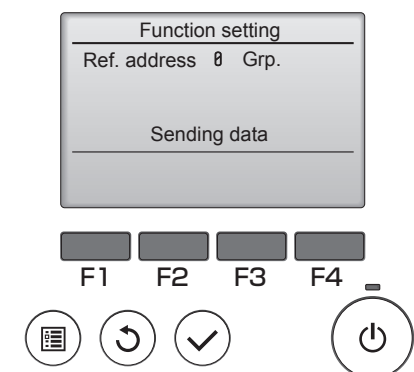

11-1-2. Selecting functions using the wired remote controller <PAR-21MAA>

First, try to familiarize yourself with the flow of the function selection procedure. In this section, an example of setting the room temperature detection position is given.

For actual operations, refer to steps ① to ⑩.

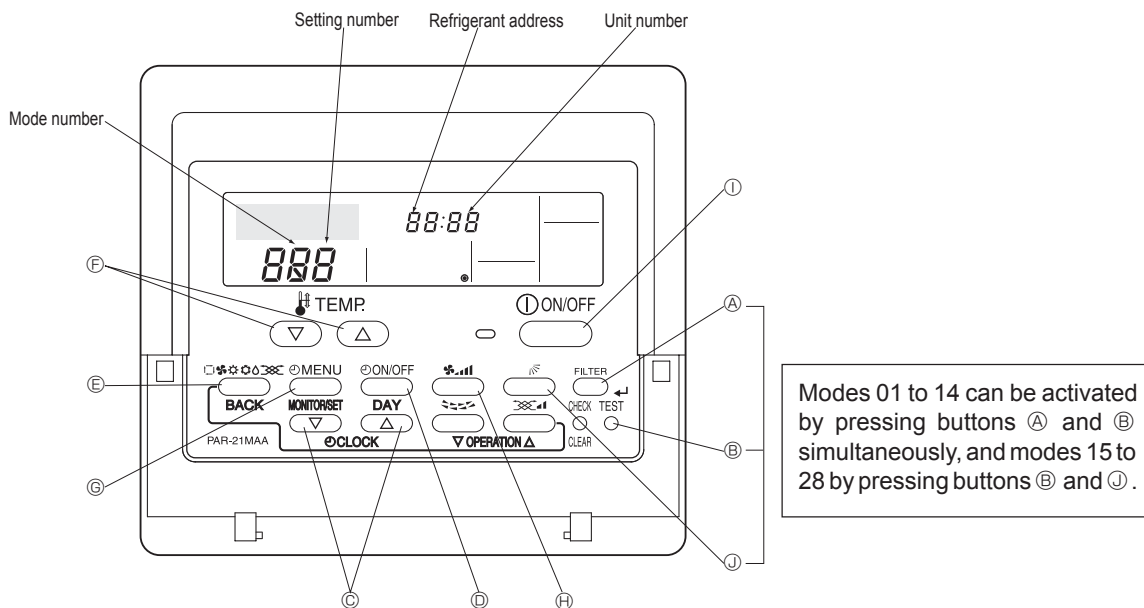

Selecting functions using the wired remote controller

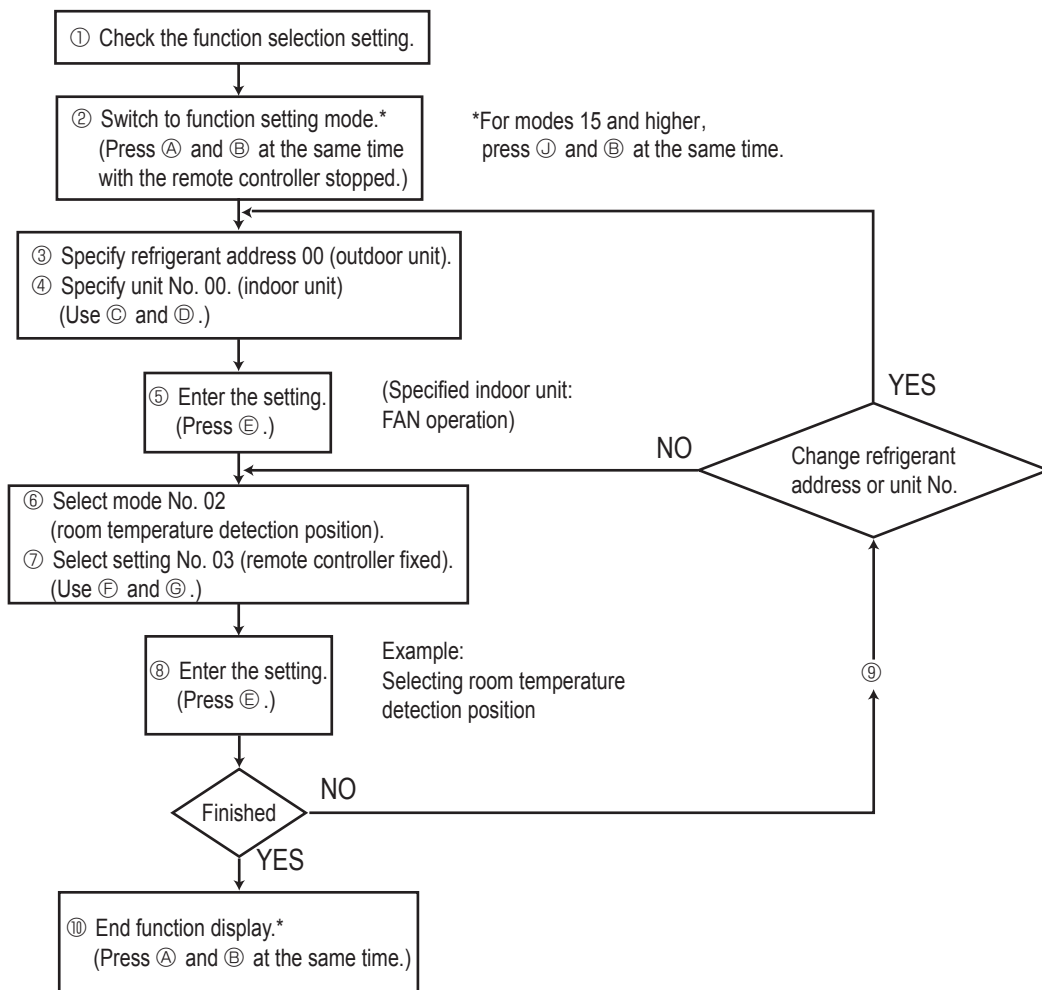

The above procedure must be carried out only if changes are necessary.

[Operating Procedure]

① Check the setting items provided by function selection.

If settings for a mode are changed by function selection, the functions of that mode will be changed accordingly. Check all the current settings according to steps ② to ⑦, fill in the "Check" column in Table 1, then change them as necessary. For initial settings, refer to the indoor unit's installation manual.

② Switch off the remote controller.

Ⓐ Hold down the **(FILTER)** (mode is 15 to 28) and **(TEST)** buttons simultaneously for at least 2 seconds. **FUNCTION SELECTION** will start to blink, then the remote controller's display content will change as shown below.

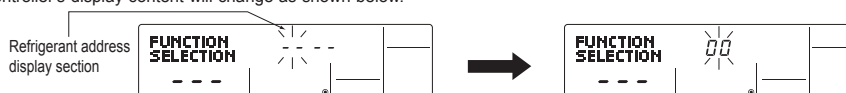

If the unit stops after **FUNCTION SELECTION** blinked for 2 seconds or "88" blinks in the room temperature display area for 2 seconds, a transmission error may have occurred. Check to see if there are any sources of noise or interference near the transmission path.

Note: If you have made operational mistakes during this procedure, exit function selection (see step ⑩), then restart from step ②.

④ Set the indoor unit number.

Ⓐ Press the **(ON/OFF)** button so that "-" blinks in the unit number display area.



Ⓒ Press the **(CLOCK)** buttons (**(V)** and **(A)**) to select the unit number of the indoor unit for which you want to perform function selection. The unit number changes to "00", "01", "02", "03", "04" and "AL" each time a button is pressed.

To set modes 01 to 06 or 15 to 22, select unit number "00".

To set modes 07 to 14 or 23 to 28, carry out as follows:

To set each indoor unit individually, select "01" to "04".

To set all the indoor units collectively, select "AL".

⑤ Confirm the refrigerant address and unit number.

Ⓒ Press the **(MODE)** button to confirm the refrigerant address and unit number.

After a while, "-" will start to blink in the mode number display area.



"88" will blink in the room temperature display area if the selected refrigerant address does not exist in the system.

Furthermore, if "F" appears and blinks in the unit number display area and the refrigerant address display area also blinks, there are no units that correspond to the selected unit number. In this case, the refrigerant address and unit number may be incorrect, so repeat steps ② and ③ to set the correct ones.

Ⓒ When the refrigerant address and unit number are confirmed by pressing the

(MODE) button, the corresponding indoor unit will start fan operation. This helps you find the location of the indoor unit for which you want to perform function selection. However, if "00" or "AL" is selected as the unit number, all the indoor units corresponding to the specified refrigerant address will start fan operation.

Example: When the refrigerant address is set to 00 and the unit number is 02.

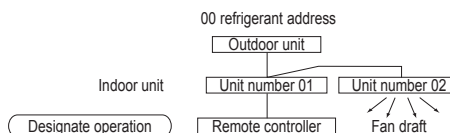

When grouping different refrigerant systems, if an indoor unit other than the one to which the refrigerant address has been set to perform fan operation, there may be another refrigerant address that is the same as the specified one. In this case, check the DIP switch of the outdoor unit to see whether such a refrigerant address exists.

⑥ Select the mode number.

Ⓒ Press the **(TEMP)** buttons (**(V)** and **(A)**) to set the desired mode number. (Only the selectable mode numbers can be selected.)

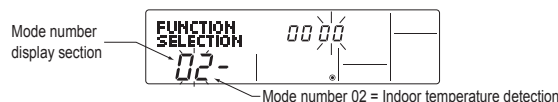

⑦ Select the setting content for the selected mode.

Ⓒ Press the **(MENU)** button. The currently selected setting number will blink, so check the currently set content.

Ⓒ Press the **(TEMP)** buttons (**(V)** and **(A)**) to select the desired setting number.

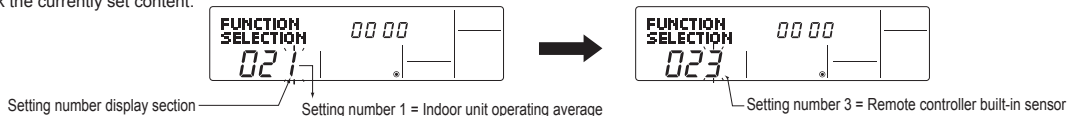

⑧ Register the settings you have made in steps ③ to ⑦.

Ⓒ Press the **(MODE)** button. The mode number and setting number will start to blink and registration starts.

The mode number and setting number will stop blinking and remain lit, indicating the end of registration.



If "-" is displayed for both the mode number and setting number and "88" blinks in the room temperature display area, a transmission error may have occurred. Check to see if there are any sources of noise or interference near the transmission path.

⑨ If you wish to continue to select other functions, repeat steps ③ to ⑧.

⑩ Complete function selection.

Ⓐ Hold down the **(FILTER)** (mode is 15 to 28) and **(TEST)** buttons simultaneously for at least 2 seconds. After a while, the function selection screen will disappear and the air conditioner OFF screen will reappear.

Do not operate the remote controller for at least 30 seconds after completing function selection. (No operations will be accepted even if they are made.)

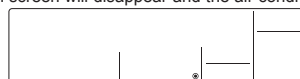

Note:

If a function of an indoor unit is changed by function selection after installation is complete, make sure that a "O" mark, etc., is given in the "Check" column of Table 1 to indicate the change.

11-1-3. Selecting functions using the wireless remote controller (Type C)

Functions can be selected with the wireless remote controller. Function selection using wireless remote controller is available only for refrigerant system with wireless function. Refrigerant address cannot be specified by the wireless remote controller.

[Flow of function selection procedure]

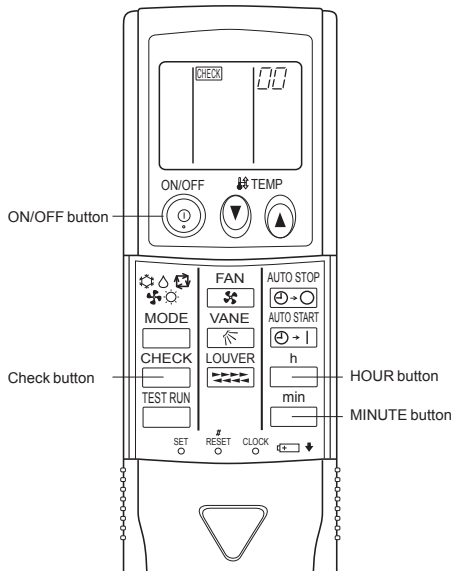

Flow of function selection procedure

The flow of the function selection procedure is shown below. This example shows how to turn off the function that raises the set temperature by 4 degrees during HEAT operation.

The procedure is given after the flow chart.

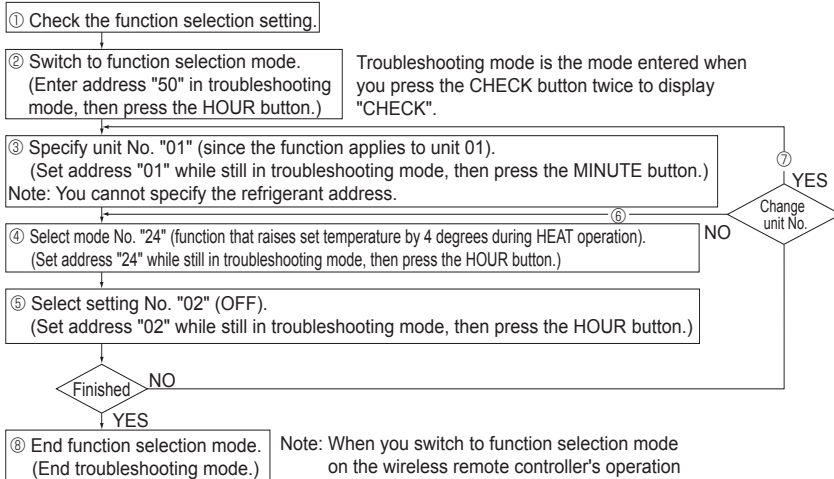

[Operating instructions]

- ① Check the function settings.
- ② Press the **CHECK** button twice continuously. → **CHECK** is lit and "00" blinks.
Press the temp **▲** button once to set "50". Direct the wireless remote controller toward the receiver of the indoor unit and press the **h** button.
- ③ Set the unit number.
Press the temp **▲** button to set the unit number. (Press "01" to specify the indoor unit whose unit number is 01.)
Direct the wireless remote controller toward the receiver of the indoor unit and press the **min** button.
(By setting unit number with the **min** button, specified indoor unit starts performing fan operation.
Detect which unit is assigned to which number using this function. If unit number is set to AL, all the indoor units in same refrigerant system start performing fan operation simultaneously.)

Notes:

1. If a unit number that cannot be recognized by the unit is entered, 3 beeps of 0.4 seconds will be heard. Re-enter the unit number setting.
2. If the signal was not received by the sensor, you will not hear a beep or a "double beep" may be heard. Re-enter the unit number setting.

- ④ Select a mode.
Press the temp **▲** button to set a mode. Press "24" to turn on the function that raises the set temperature by 4 degrees during heat operation. Direct the wireless remote controller toward the sensor of the indoor unit and press the **h** button.
→ The sensor-operation indicator will blink and beeps will be heard to indicate the current setting number.
Current setting number: 1 = 1 beep (one second)
2 = 2 beeps (one second each)
3 = 3 beeps (one second each)

Notes:

1. If a mode number that cannot be recognized by the unit is entered, 3 beeps of 0.4 seconds will be heard. Re-enter the mode number.
2. If the signal was not received by the sensor, you will not hear a beep or a "double beep" may be heard. Re-enter the mode number.

- ⑤ Select the setting number.
Press the temp **▲** button to select the setting number. (02: Not available)
Direct the wireless remote controller toward the receiver of the indoor unit and press the **h** button.
→ The sensor-operation indicator will blink and beeps will be heard to indicate the the setting number.
Setting number: 1 = 2 beeps (0.4 seconds each)
2 = 2 beeps (0.4 seconds each, repeated twice)
3 = 2 beeps (0.4 seconds each, repeated 3 times)

Notes:

1. If a setting number that cannot be recognized by the unit is entered, the setting will turn back to the original setting.
2. If the signal was not received by the sensor, you will not hear a beep or a "double beep" may be heard. Re-enter the setting number.
- ⑥ Repeat steps ④ and ⑤ to make an additional setting without changing unit number.
- ⑦ Repeat steps ③ to ⑤ to change unit number and make function settings on it.
- ⑧ Complete the function settings.
Press **Ⓞ** button.

* Do not use the wireless remote controller for 30 seconds after completing the function setting.

11-2. FUNCTION SELECTION OF REMOTE CONTROLLER

11-2-1. PAR-3xMAA ("x" represents 0 or later)

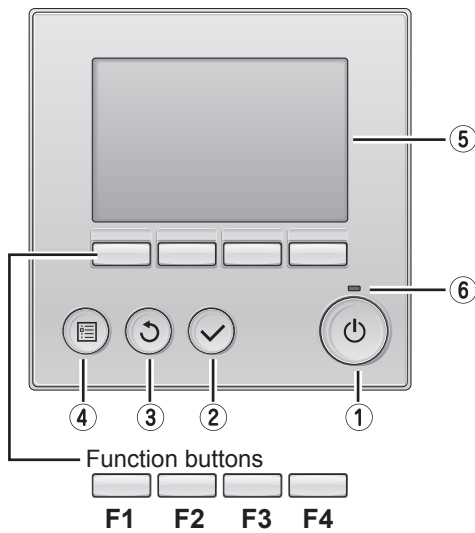

① ON/OFF button

Press to turn ON/OFF the indoor unit.

② SELECT button

Press to save the setting.

③ RETURN button

Press to return to the previous screen.

④ MENU button

Press to bring up the Main menu.

⑤ Backlit LCD

Operation settings will appear.
When the backlight is off, pressing any button turns the backlight on and it will stay lit for a certain period of time depending on the screen.

When the backlight is off, pressing any button turns the backlight on and does not perform its function. (except for the  (ON/OFF) button)

The functions of the function buttons change depending on the screen. Refer to the button function guide that appears at the bottom of the LCD for the functions they serve on a given screen.

When the system is centrally controlled, the button function guide that corresponds to the locked button will not appear.

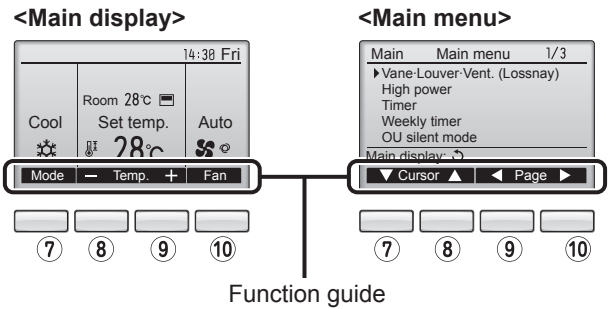

⑥ ON/OFF lamp

This lamp lights up in green while the unit is in operation. It blinks while the remote controller is starting up or when there is an error.

⑦ Function button **F1**

Main display : Press to change the operation mode.
Main menu : Press to move the cursor down.

⑧ Function button **F2**

Main display : Press to decrease temperature.
Main menu : Press to move the cursor up.

⑨ Function button **F3**

Main display : Press to increase temperature.
Main menu : Press to go to the previous page.

⑩ Function button **F4**

Main display : Press to change the fan speed.
Main menu : Press to go to the next page.

<Menu structure of PAR-3xMAA ("x" represents 0 or later)>

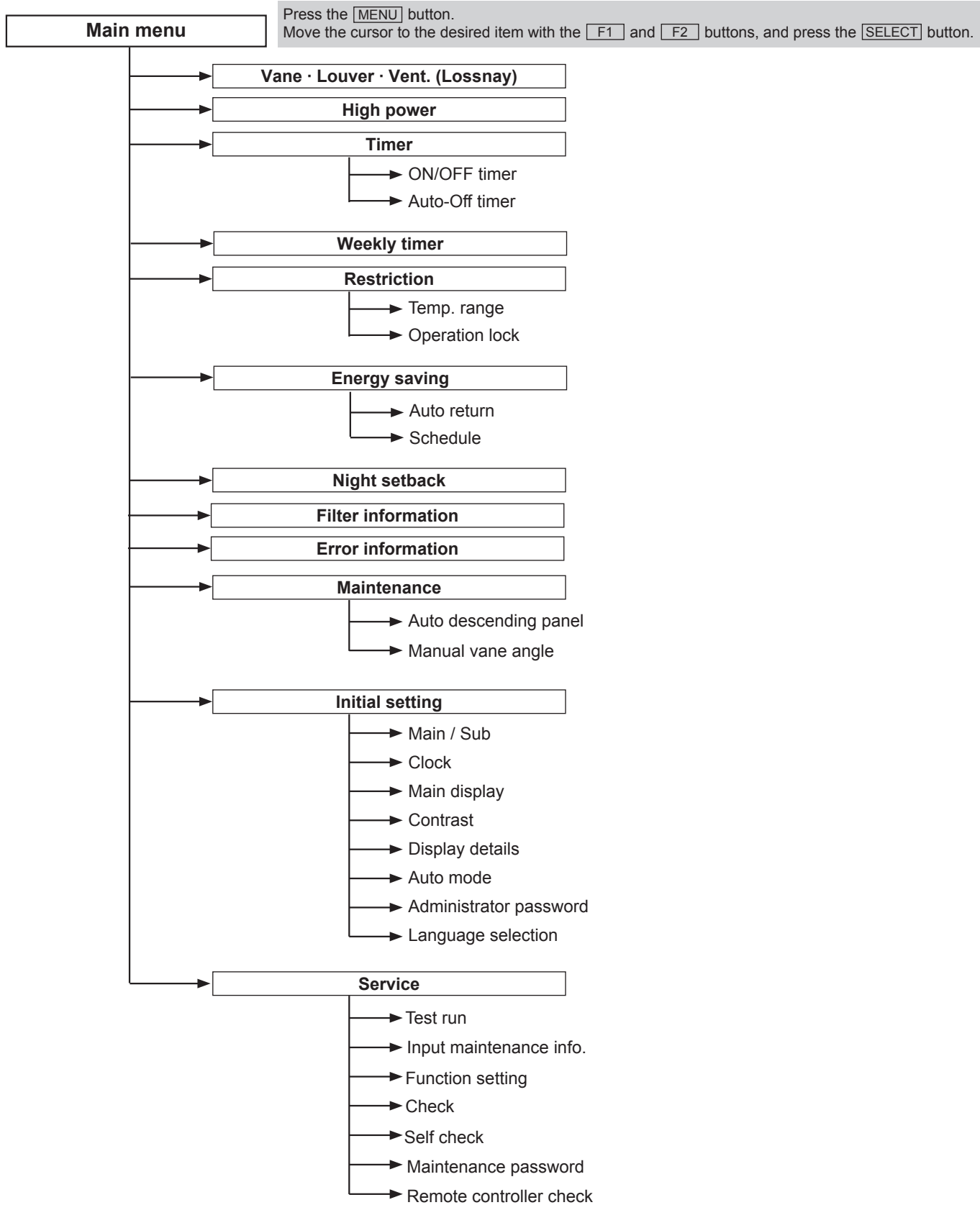

Not all functions are available on all models of indoor units.

<Main menu list of PAR-3xMAA ("x" represents 0 or later)>

Setting and display items		Setting details
Vane · Louver · Vent. (Lossnay)		<p>Use to set the vane angle.</p> <ul style="list-style-type: none"> • Select a desired vane setting from five different settings. <p>Use to turn ON/OFF the louver.</p> <ul style="list-style-type: none"> • Select a desired setting from "ON" and "OFF." <p>Use to set the amount of ventilation.</p> <ul style="list-style-type: none"> • Select a desired setting from "Off," "Low," and "High."
High power		<p>Use to reach the comfortable room temperature quickly.</p> <ul style="list-style-type: none"> • Units can be operated in the High-power mode for up to 30 minutes.
Timer	ON/OFF timer*	<p>Use to set the operation ON/OFF times.</p> <ul style="list-style-type: none"> • Time can be set in 5-minute increments.
	Auto-Off timer	<p>Use to set the Auto-Off time.</p> <ul style="list-style-type: none"> • Time can be set to a value from 30 to 240 in 10-minute increments.
Weekly timer*		<p>Use to set the weekly operation ON/OFF times.</p> <ul style="list-style-type: none"> • Up to 8 operation patterns can be set for each day. (Not valid when the ON/OFF timer is enabled.)
Restriction	Temp. range	<p>Use to restrict the preset temperature range.</p> <ul style="list-style-type: none"> • Different temperature ranges can be set for different operation modes.
	Operation lock	<p>Use to lock selected functions.</p> <ul style="list-style-type: none"> • The locked functions cannot be operated.
Energy saving	Auto return	<p>Use to get the units to operate at the preset temperature after performing energy-save operation for a specified time period.</p> <ul style="list-style-type: none"> • Time can be set to a value from 30 and 120 in 10-minute increments. (This function will not be valid when the preset temperature ranges are restricted.)
	Schedule*	<p>Set the start/stop times to operate the units in the energy-save mode for each day of the week, and set the energy-saving rate.</p> <ul style="list-style-type: none"> • Up to 4 energy-save operation patterns can be set for each day. • Time can be set in 5-minute increments. • Energy-saving rate can be set to a value from 0% or 50 to 90% in 10% increments.
Night setback*		<p>Use to make Night setback settings.</p> <ul style="list-style-type: none"> • Select "Yes" to enable the setting, and "No" to disable the setting. The temperature range and the start/stop times can be set.
Filter information		<p>Use to check the filter status.</p> <ul style="list-style-type: none"> • The filter sign can be reset.
Error information		<p>Use to check error information when an error occurs.</p> <ul style="list-style-type: none"> • Check code, error source, refrigerant address, unit model, manufacturing number, contact information (dealer's phone number) can be displayed. (The unit model, manufacturing number, and contact information need to be registered in advance to be displayed.)
Maintenance	Auto descending panel	Auto descending panel (Optional parts) Up/Down you can do.
	Manual vane angle	Use to set the vane angle for each vane to a fixed position.
Initial setting	Main/Sub	When connecting two remote controllers, one of them needs to be designated as a sub controller.
	Clock	Use to set the current time.
	Main display	Use to switch between "Full" and "Basic" modes for the Main display. • The initial setting is "Full."
	Contrast	Use to adjust screen contrast.
	Display details	<p>Make the settings for the remote controller related items as necessary.</p> <p>Clock: The initial settings are "Yes" and "24h" format. Temperature: Set either Celsius (°C) or Fahrenheit (°F). Room temp. : Set Show or Hide. Auto mode: Set the Auto mode display or Only Auto display.</p>
	Auto mode	Whether or not to use the Auto mode can be selected by using the button. This setting is valid only when indoor units with the Auto mode function are connected.
	Administrator password	<p>The administrator password is required to make the settings for the following items.</p> <ul style="list-style-type: none"> • Timer setting • Energy-save setting • Weekly timer setting • Restriction setting • Outdoor unit silent mode setting • Night set back
	Language selection	Use to select the desired language.
Service	Test run	<p>Select "Test run" from the Service menu to bring up the Test run menu.</p> <ul style="list-style-type: none"> • Test run • Drain pump test run
	Input maintenance	<p>Select "Input maintenance Info." from the Service menu to bring up the Maintenance information screen. The following settings can be made from the Maintenance information screen.</p> <ul style="list-style-type: none"> • Model name input • Serial No. input • Dealer information input
	Function setting	Make the settings for the indoor unit functions via the remote controller as necessary.
	Check	<p>Error history: Display the error history and execute "delete error history". Refrigerant leak check: Refrigerant leaks can be judged. Smooth maintenance: The indoor and outdoor maintenance data can be displayed. Request code: Details of the operation data including each thermistor temperature and error history can be checked.</p>
	Self check	Error history of each unit can be checked via the remote controller.
	Maintenance password	Use to change the maintenance password.
	Remote controller check	When the remote controller does not work properly, use the remote controller checking function to troubleshoot the problem.

* Clock setting is required.

11-2-2. PAR-21MAA

The setting of the following remote controller functions can be changed using the remote controller function selection mode. Change the setting when needed.

Item 1	Item 2	Item 3 (Setting content)
1.Change language ("CHANGE LANGUAGE")	Language setting to display	• Display in multiple languages is possible.
2.Function limit ("FUNCTION SELECTION")	(1) Operation function limit setting (operation lock) ("LOCKING FUNCTION") (2) Use of automatic mode setting ("SELECT AUTO MODE") (3) Temperature range limit setting ("LIMIT TEMP FUNCTION")	• Setting the range of operation limit (operation lock) • Setting the use or non-use of "automatic" operation mode • Setting the temperature adjustable range (maximum, minimum)
3.Mode selection ("MODE SELECTION")	(1) Remote controller main/sub setting ("CONTROLLER MAIN/SUB") (2) Use of clock setting ("CLOCK") (3) Timer function setting ("WEEKLY TIMER") (4) Contact number setting for error situation ("CALL.")	• Selecting main or sub remote controller * When 2 remote controllers are connected to 1 group, 1 controller must be set to sub. • Setting the use or non-use of clock function • Setting the timer type • Contact number display in case of error • Setting the telephone number
4.Display change ("DISP MODE SETTING")	(1) Temperature display °C/°F setting ("TEMP MODE °C/°F") (2) Room air temperature display setting ("ROOM TEMP DISP SELECT") (3) Automatic cooling/heating display setting ("AUTO MODE DISP C/H")	• Setting the temperature unit (°C or °F) to display • Setting the use or non-use of the display of indoor (room) air temperature • Setting the use or non-use of the display of "Cooling" or "Heating" display during operation with automatic mode

[Function selection flowchart] Refer to next page.

[1] Stop the air conditioner to start remote controller function selection mode. → [2] Select from item1. → [3] Select from item2. → [4] Make the setting. (Details are specified in item3) → [5] Setting completed. → [6] Change the display to the normal one. (End)

[Detailed setting]

[4] -1. CHANGE LANGUAGE setting

The language that appears on the dot display can be selected.

- Press the [⊖ MENU] button to change the language.
- ① Japanese (JP), ② English (GB), ③ German (D), ④ Spanish (E),
⑤ Russian (RU), ⑥ Italian (I), ⑦ Chinese (CH), ⑧ French (F)

[4] -2. Function limit

(1) Operation function limit setting (operation lock)

- To switch the setting, press the [⊖ ON/OFF] button.
- ① no1 : All operation buttons except [⊖ ON/OFF] button are locked.
- ② no2 : All operation buttons are locked.
- ③ OFF (Initial setting value) : Operation lock setting is not made
- * To make the operation lock setting valid on the normal screen, it is necessary to press buttons (Press and hold down the [FILTER] and [⊖ ON/OFF] buttons at the same time for 2 seconds.) on the normal screen after the above setting is made.

(2) Use of automatic mode setting

When the remote controller is connected to the unit that has automatic operation mode, the following settings can be made.

- To switch the setting, press the [⊖ ON/OFF] button.
- ① ON (Initial setting value) : The automatic mode is displayed when the operation mode is selected.
- ② OFF : The automatic mode is not displayed when the operation mode is selected.

[4] -3. Mode selection setting

After this setting is made, the temperature can be changed within the set range.

- To switch the setting, press the [⊖ ON/OFF] button.
- ① LIMIT TEMP COOL MODE :
The temperature range can be changed on cooling/dry mode.
- ② LIMIT TEMP HEAT MODE :
The temperature range can be changed on heating mode.
- ③ LIMIT TEMP AUTO MODE :
The temperature range can be changed on automatic mode.
- ④ OFF (initial setting) : The temperature range limit is not active.
- * When the setting, other than OFF, is made, the temperature range limit setting on cooling, heating and automatic mode is made at the same time. However the range cannot be limited when the set temperature range has not changed.
- To increase or decrease the temperature, press the [⬇️ TEMP (▽) or (Δ)] button.
- To switch the upper limit setting and the lower limit setting, press the [⚙️] button. The selected setting will flash and the temperature can be set.
- Settable range
Cooling/Dry mode : Lower limit: 19 °C ~ 30 °C Upper limit: 30 °C ~ 19 °C
Heating mode : Lower limit: 17 °C ~ 28 °C Upper limit: 28 °C ~ 17 °C
Automatic mode : Lower limit: 19 °C ~ 28 °C Upper limit: 28 °C ~ 19 °C

[4] -3. Mode selection setting

(1) Remote controller main/sub setting

- To switch the setting, press the [⊖ ON/OFF] button.
- ① Main : The controller will be the main controller.
- ② Sub : The controller will be the sub controller.

(2) Use of clock setting

- To switch the setting, press the [⊖ ON/OFF] button.
- ① ON : The clock function can be used.
- ② OFF : The clock function cannot be used.

(3) Timer function setting

- To switch the setting, press the [⊖ ON/OFF] button. (Choose one of the followings.)
- ① WEEKLY TIMER (initial setting):
The weekly timer can be used.
- ② AUTO OFF TIMER: The auto off timer can be used.
- ③ SIMPLE TIMER: The simple timer can be used.
- ④ TIMER MODE OFF: The timer mode cannot be used.
- * When the use of clock setting is OFF, the "WEEKLY TIMER" cannot be used.

(4) Contact number setting for error situation

- To switch the setting, press the [⊖ ON/OFF] button.
- ① CALL OFF : The set contact numbers are not displayed in case of error.
- ② CALL **** * : The set contact numbers are displayed in case of error.
- CALL_ : The contact number can be set when the display is as shown on the left.

- Setting the contact numbers
To set the contact numbers, follow the following procedures. Move the flashing cursor to set numbers. Press the [⬇️ TEMP (▽) and (Δ)] button to move the cursor to the right (left). Press the [⊖ CLOCK (▽) and (Δ)] button to set the numbers.

[4] -4. Display change setting

(1) Temperature display °C/°F setting

- To switch the setting, press the [⊖ ON/OFF] button.
- ① °C : The temperature unit °C is used.
- ② °F : The temperature unit °F is used.

(2) Room air temperature display setting

- To switch the setting, press the [⊖ ON/OFF] button.
- ① ON : The room air temperature is displayed.
- ② OFF : The room air temperature is not displayed.

(3) Automatic cooling/heating display setting

- To switch the setting, press the [⊖ ON/OFF] button.
- ① ON : One of "Automatic cooling" and "Automatic heating" is displayed under the automatic mode is running.
- ② OFF : Only "Automatic" is displayed under the automatic mode.

[Function selection flowchart]
Setting language (English)

Change Language

Function selection

Mode selection

Display mode setting

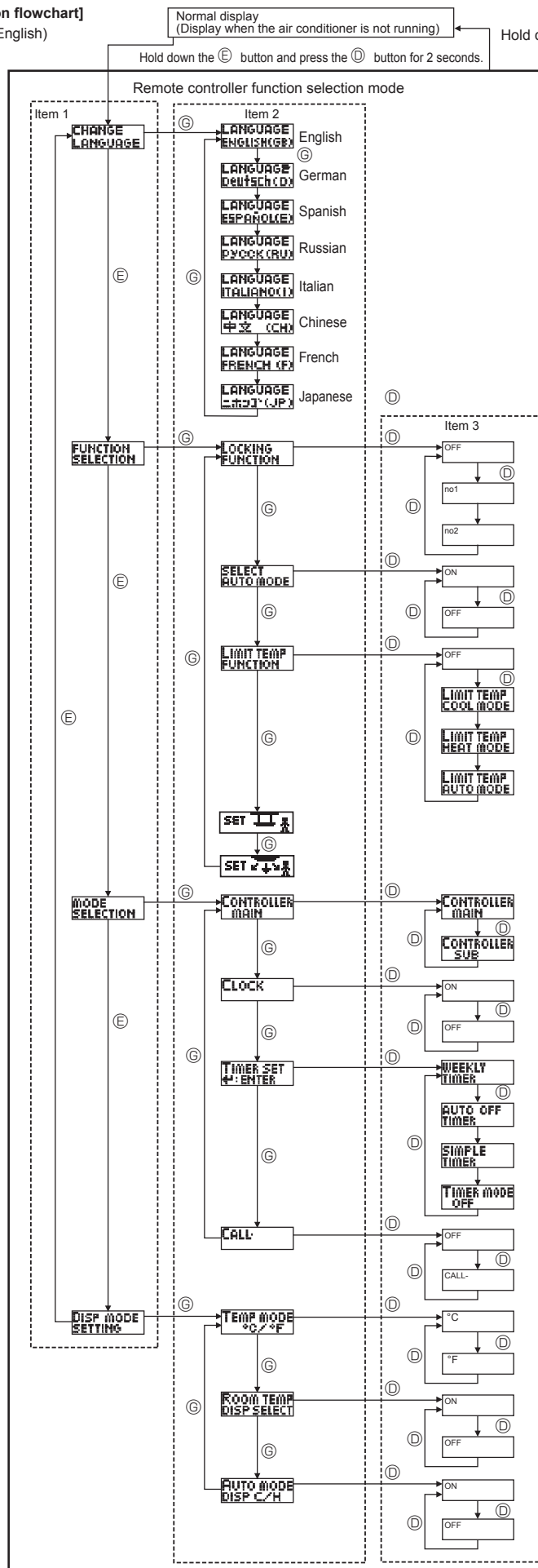

Hold down the **E** button and press the **D** button for 2 seconds.

- E** Press the operation mode button.
- G** Press the TIMER MENU button.
- D** Press the TIMER ON/OFF button.

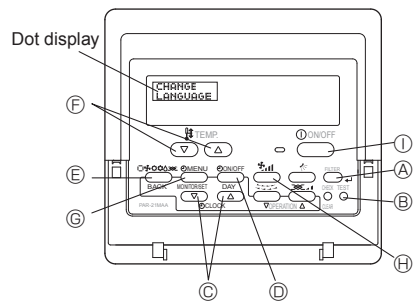

- Operation lock setting is not used. (Initial setting value)
All operation buttons except On/Off button are locked.
- All operation buttons are locked.
- The automatic mode is displayed when the operation mode is selected. (Initial setting value)
The automatic mode is not displayed when the operation mode is selected.
- The temperature range limit is not active. (Initial setting value)
The temperature range can be changed on cooling/dry mode.
The temperature range can be changed on heating mode.
The temperature range can be changed on automatic mode.
- Automatic filter elevation panel up/down operation mode
Not necessary to set this mode. Refer to OPERATION MANUAL of Optional Parts (Panel) for details on operation.
- Fixed air flow direction mode
Not necessary to set this mode. Refer to OPERATION MANUAL of indoor unit for details on operation.
- The remote controller will be the main controller. (Initial setting value)
The remote controller will be the sub controller.
- The clock function can be used. (Initial setting value)
The clock function cannot be used.
- Weekly timer can be used. (Initial setting value)
Auto off timer can be used.
Simple timer can be used.
Timer mode cannot be used.
- The set contact numbers are not displayed in case of error. (Initial setting value)
The set contact numbers are displayed in case of error.
- The temperature unit °C is used. (Initial setting value)
The temperature unit °F is used.
- Room air temperature is displayed. (Initial setting value)
Room air temperature is not displayed.
- One of "Automatic cooling" and "Automatic heating" is displayed under the automatic mode is running. (Initial setting value)
Only "Automatic" is displayed under the automatic mode.

12 MONITORING THE OPERATION DATA BY THE REMOTE CONTROLLER

12-1. HOW TO "MONITOR THE OPERATION DATA"

12-1-1. PAR-3xMAA ("x" represents 0 or later)

Details on the operation data including each thermistor temperature and error history can be confirmed with the remote controller.

① Select "Service" from the Main menu, and press the button.

Select "Check" with the **F1** or **F2** button, and press the button.

Select "Request code" with the **F1** or **F2** button, and press the button.

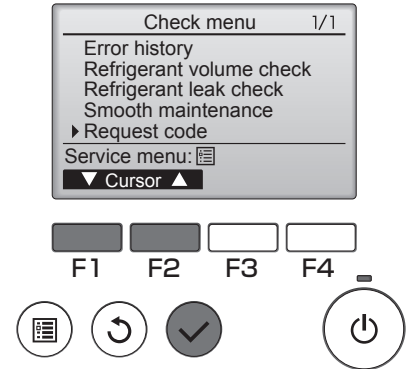

② Set the Refrigerant address and Request code.

Select the item to be changed with the **F1** or **F2** button.

Select the required setting with the **F3** or **F4** button.

- <Ref.address>setting [0] – [15]
- <Request code>setting

Press the button, Data will be collected and displayed.

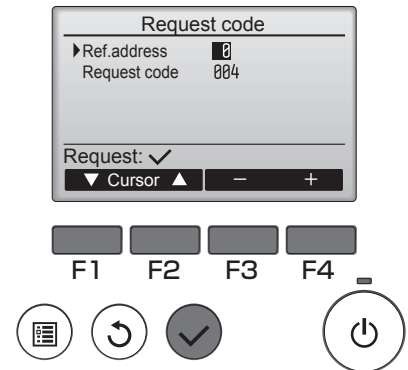

Request code: 004
Discharge temperature: 69°C

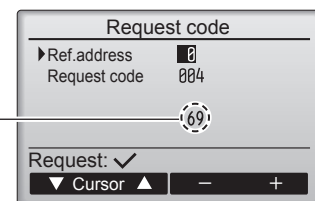

12-1-2. PAR-21MAA

- Turn on the [Monitoring the operation data]

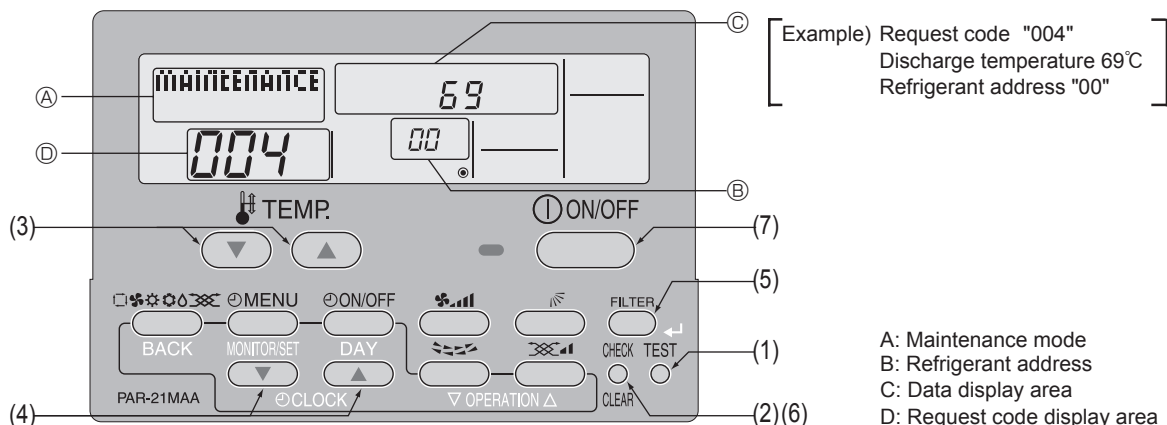

- (1) Press the **TEST** button for 3 seconds so that [Maintenance mode] appears on the screen (at A).
- (2) Press the **CHECK** button for 3 seconds to switch to [Maintenance monitor].
 Note) It is not possible to switch to [Maintenance monitor] during data request in maintenance mode (i.e., while " - - - " is blinking) since no buttons are operative.

- Operating the service inspection monitor

[- - -] appears on the screen (at D) when [Maintenance monitor] is activated.

(The display (at D) now allows you to set a request code No.)

- (3) Press the [TEMP] buttons (**▽** and **△**) to select the desired refrigerant address.



- (4) Press the [CLOCK] buttons (**▽** and **△**) to set the desired request code No.
- (5) Press the **FILTER** button to perform data request.

(The requested data will be displayed at C in the same way as in maintenance mode.)

Data collected during operation of the remote controller will be displayed.

The collected data such as temperature data will not be updated automatically even if the data changes.

To display the updated data, carry out step (4) again.

- Canceling the Monitoring the operation data

- (6) While [Maintenance monitor] is displayed, press the **CHECK** button for 3 seconds to return to maintenance mode.
- (7) To return to normal mode, press the **ON/OFF** button.

12-2. REQUEST CODE LIST

Note: Certain indoor/outdoor combinations do not have the request code function; therefore, no request codes are displayed.

Request code	Request content	Description (Display range)	Unit	Remarks
0	Operation state	Refer to 12-2-1. Detail Contents in Request Code.	–	
1	Compressor-Operating current (rms)	0 – 50	A	
2	Compressor-Accumulated operating time	0 – 9999	10 hours	
3	Compressor-Number of operation times	0 – 9999	100 times	
4	Discharge temperature (TH4)	3 – 217	°C	
5	Outdoor unit - Liquid pipe 1 temperature (TH3)	-40 – 90	°C	
6	Outdoor unit - Liquid pipe 2 temperature	-40 – 90	°C	
7	Outdoor unit-2-phase pipe temperature (TH6)	-39 – 88	°C	
8	Outdoor unit-Suction pipe temperature (TH32)	-39 – 88	°C	
9	Outdoor unit-Outside air temperature (TH7)	-39 – 88	°C	
10	Outdoor unit-Heat sink temperature (TH8)	-40 – 200	°C	
11				
12	Discharge superheat (SHd)	0 – 255	°C	
13	Sub-cool (SC)	0 – 130	°C	
14	Pressure saturation temperature (T _{63HS})	-39 – 88	°C	
15				
16	Compressor-Operating frequency	0 – 255	Hz	
17	Compressor-Target operating frequency	0 – 255	Hz	
18	Outdoor unit-Fan output step	0 – 10	Step	
19	Outdoor unit-Fan 1 speed (Only for air conditioners with DC fan motor)	0 – 9999	rpm	
20	Outdoor unit-Fan 2 speed (Only for air conditioners with DC fan motor)	0 – 9999	rpm	"0" is displayed if the air conditioner is a single-fan type.
21				
22	LEV (A) opening	0 – 500	Pulses	
23	LEV (B) opening	0 – 500	Pulses	
24	LEV (C) opening	0 – 500	Pulses	
25	Primary current	0 – 50	A	
26	DC bus voltage	180 – 370	V	
27				
28				
29	Number of connected indoor units	0 – 4	Units	
30	Indoor unit-Setting temperature	17 – 30	°C	
31	Indoor unit-Intake air temperature <Thermo judge temperature>	8 – 39	°C	
32	Indoor unit-Intake air temperature (Unit No. 1) <Heat mode-4-degrees correction>	8 – 39	°C	"0" is displayed if the target unit is not present.
33	Indoor unit-Intake air temperature (Unit No. 2) <Heat mode-4-degrees correction>	8 – 39	°C	↑
34	Indoor unit-Intake air temperature (Unit No. 3) <Heat mode-4-degrees correction>	8 – 39	°C	↑
35	Indoor unit-Intake air temperature (Unit No. 4) <Heat mode-4-degrees correction>	8 – 39	°C	↑
36				
37	Indoor unit - Liquid pipe temperature (Unit No. 1)	-39 – 88	°C	"0" is displayed if the target unit is not present.
38	Indoor unit - Liquid pipe temperature (Unit No. 2)	-39 – 88	°C	↑
39	Indoor unit - Liquid pipe temperature (Unit No. 3)	-39 – 88	°C	↑
40	Indoor unit - Liquid pipe temperature (Unit No. 4)	-39 – 88	°C	↑
41				
42	Indoor unit-Cond./Eva. pipe temperature (Unit No. 1)	-39 – 88	°C	"0" is displayed if the target unit is not present.
43	Indoor unit-Cond./Eva. pipe temperature (Unit No. 2)	-39 – 88	°C	↑
44	Indoor unit-Cond./Eva. pipe temperature (Unit No. 3)	-39 – 88	°C	↑
45	Indoor unit-Cond./Eva. pipe temperature (Unit No. 4)	-39 – 88	°C	↑
46				
47				
48	Thermo ON operating time	0 – 999	Minutes	
49	Test run elapsed time	0 – 120	Minutes	← Not possible to activate maintenance mode during the test run.

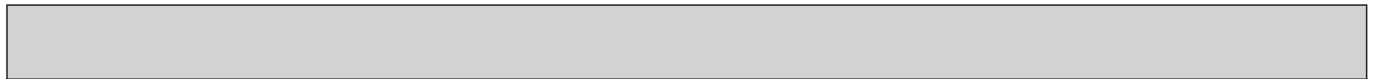

Request code	Request content	Description (Display range)	Unit	Remarks
50	Indoor unit-Control state	Refer to 12-2-1.Detail Contents in Request Code.	—	
51	Outdoor unit-Control state	Refer to 12-2-1.Detail Contents in Request Code.	—	
52	Compressor-Frequency control state	Refer to 12-2-1.Detail Contents in Request Code.	—	
53	Outdoor unit-Fan control state	Refer to 12-2-1.Detail Contents in Request Code.	—	
54	Actuator output state	Refer to 12-2-1.Detail Contents in Request Code.	—	
55	Error content (U9)	Refer to 12-2-1.Detail Contents in Request Code.	—	
56				
57				
58				
59				
60	Signal transmission demand capacity	0 – 255	%	
61	Contact demand capacity	Refer to 12-2-1.Detail Contents in Request Code.	—	
62	External input state (silent mode, etc.)	Refer to 12-2-1.Detail Contents in Request Code.	—	
63				
64				
65				
66				
67				
68				
69				
70	Outdoor unit-Capacity setting display	Refer to 12-2-1.Detail Contents in Request Code.	—	
71	Outdoor unit-Setting information	Refer to 12-2-1.Detail Contents in Request Code.	—	
72				
73	Outdoor unit-SW1 setting information	Refer to 12-2-1.Detail Contents in Request Code.	—	
74	Outdoor unit-SW2 setting information	Refer to 12-2-1.Detail Contents in Request Code.	—	
75				
76	Outdoor unit-SW4 setting information	Refer to 12-2-1.Detail Contents in Request Code.	—	
77	Outdoor unit-SW5 setting information	Refer to 12-2-1.Detail Contents in Request Code.	—	
78	Outdoor unit-SW6 setting information	Refer to 12-2-1.Detail Contents in Request Code.	—	
79	Outdoor unit-SW7 setting information	Refer to 12-2-1.Detail Contents in Request Code.	—	
80	Outdoor unit-SW8 setting information	Refer to 12-2-1.Detail Contents in Request Code.	—	
81	Outdoor unit-SW9 setting information	Refer to 12-2-1.Detail Contents in Request Code.	—	
82	Outdoor unit-SW10 setting information	Refer to 12-2-1.Detail Contents in Request Code.	—	
83				
84	M-NET adapter connection (presence/absence)	"0000": Not connected "0001": Connected	—	
85				
86				
87				
88				
89	Display of execution of replace/wash operation	"0000": Not washed "0001": Washed	—	
90	Outdoor unit-Microprocessor version information	Examples) Ver 5.01 → "0501"	Ver	
91	Outdoor unit-Microprocessor version information (sub No.)	Auxiliary information (displayed after version information) Examples) Ver 5.01 A000 → "A000"	—	
92				
93				
94				
95				
96				
97				
98				
99				
100	Outdoor unit - Error postponement history 1 (latest)	Displays postponement code. (" - " is displayed if no postponement code is present)	Code	
101	Outdoor unit - Error postponement history 2 (previous)	Displays postponement code. (" - " is displayed if no postponement code is present)	Code	
102	Outdoor unit - Error postponement history 3 (last but one)	Displays postponement code. (" - " is displayed if no postponement code is present)	Code	



Request code	Request content	Description (Display range)	Unit	Remarks
103	Error history 1 (latest)	Displays error history. ("--" is displayed if no history is present.)	Code	
104	Error history 2 (second to last)	Displays error history. ("--" is displayed if no history is present.)	Code	
105	Error history 3 (third to last)	Displays error history. ("--" is displayed if no history is present.)	Code	
106	Abnormal thermistor display (TH3/TH6/TH7/TH8)	3 : TH3 6 : TH6 7 : TH7 8 : TH8 0 : No thermistor error	Sensor number	
107	Operation mode at time of error	Displayed in the same way as request code "0".	—	
108	Compressor-Operating current at time of error	0 – 50	A	
109	Compressor-Accumulated operating time at time of error	0 – 9999	10 hours	
110	Compressor-Number of operation times at time of error	0 – 9999	100 times	
111	Discharge temperature at time of error	3 – 217	°C	
112	Outdoor unit - Liquid pipe 1 temperature (TH3) at time of error	-40 – 90	°C	
113	Outdoor unit - Liquid pipe 2 temperature at time of error	-40 – 90	°C	
114	Outdoor unit-2-phase pipe temperature (TH6) at time of error	-39 – 88	°C	
115				
116	Outdoor unit-Outside air temperature (TH7) at time of error	-39 – 88	°C	
117	Outdoor unit-Heat sink temperature (TH8) at time of error	-40 – 200	°C	
118	Discharge superheat (SHd) at time of error	0 – 255	°C	
119	Sub-cool (SC) at time of error	0 – 130	°C	
120	Compressor-Operating frequency at time of error	0 – 255	Hz	
121	Outdoor unit at time of error • Fan output step	0 – 10	Step	
122	Outdoor unit at time of error • Fan 1 speed (Only for air conditioners with DC fan)	0 – 9999	rpm	
123	Outdoor unit at time of error • Fan 2 speed (Only for air conditioners with DC fan)	0 – 9999	rpm	"0" is displayed if the air conditioner is a single-fan type.
124				
125	LEV (A) opening at time of error	0 – 500	Pulses	
126	LEV (B) opening at time of error	0 – 500	Pulses	
127				
128				
129	Pressure saturation temperature (T _{63HS}) at time of error	-39 – 88	°C	
130	Thermo ON time until operation stops due to error	0 – 999	Minutes	
131				
132	Indoor - Liquid pipe temperature at time of error	-39 – 88	°C	Average value of all indoor units is displayed if the air conditioner consists of 2 indoor units (twin).
133	Indoor - Cond./Eva. temperature at time of error	-39 – 88	°C	Average value of all indoor units is displayed if the air conditioner consists of 2 indoor units (twin).
134	Indoor at time of error • Intake air temperature <Thermo judge temperature>	-39 – 88	°C	
135				
136				
137				
138				
139				
140				
~				
146				
147				
148				
149				
150	Indoor - Actual intake air temperature	-39 – 88	°C	
151	Indoor - Liquid pipe temperature	-39 – 88	°C	
152	Indoor - Cond./Eva. temperature	-39 – 88	°C	



Request code	Request content	Description (Display range)	Unit	Remarks
153				
154	Indoor-Fan operating time (After filter is reset)	0 – 9999	1 hour	
155	Indoor-Total operating time (Fan motor ON time)	0 – 9999	10 hours	
156				
157	Indoor fan output value (Sj value)	0 – 255 Fan control data	–	For indoor fan phase control
158	Indoor fan output value (Pulsation ON/OFF)	"00 ***" "****" indicates fan control data.	–	For indoor fan pulsation control
159	Indoor fan output value (duty value)	"00 ***" "****" indicates fan control data.	–	For indoor DC brushless motor control
160				
161				
162	Indoor unit-Model setting information	Refer to 12-2-1 Detail Contents in Request Code.	–	
163	Indoor unit-Capacity setting information	Refer to 12-2-1 Detail Contents in Request Code.	–	
164	Indoor unit-SW3 information	Undefined	–	
165	Wireless pair No. (indoor control board side) setting	Refer to 12-2-1 Detail Contents in Request Code.	–	
166	Indoor unit-SW5 information	Undefined	–	
167				
~				
189				
190	Indoor unit-Microprocessor version information	Examples) Ver 5.01 → "0501"	Ver	
191	Indoor unit-Microprocessor version information (sub No.)	Auxiliary information (displayed after version information) Examples) Ver 5.01 A000 → "A000"	–	
192				
~				
764				
765	Stable operation (Heat mode)	This request code is not provided to collect data. It is used to fix the operation state.		
766	Stable operation (Cool mode)	This request code is not provided to collect data. It is used to fix the operation state.		
767	Stable operation cancellation	This request code is not provided to collect data. It is used to cancel the operation state that has been fixed by request codes "765" and "766".		

12-2-1. Detail Contents in Request Code

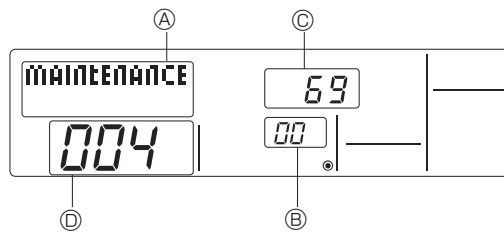

[Example) Request code "004"
Discharge temperature 69°C
Refrigerant address "00"]

- A: Maintenance mode display
- B: Refrigerant address
- C: Data display area
- D: Request code display area

[Operation state] (Request code "0")

Data display

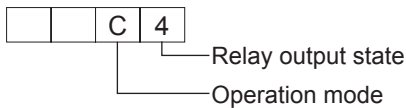

Operation mode

Display	Operation mode
0	STOP • FAN
C	COOL • DRY
H	HEAT
d	DEFROST

Relay output state

Display	Power currently supplied to compressor	Compressor	Four-way valve	Solenoid valve
0	—	—	—	—
1				ON
2			ON	
3			ON	ON
4		ON		
5		ON		ON
6		ON	ON	
7		ON	ON	ON
8	ON			
A	ON		ON	

[Indoor unit – Control state] (Request code "50")

Data display

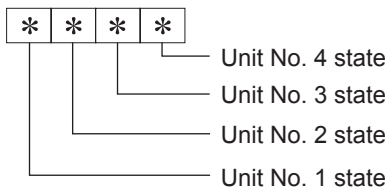

Display	State
0	Normal
1	Preparing for heat operation
2	—
3	—
4	Heater is ON.
5	Anti-freeze protection is ON.
6	Overheat protection is ON.
7	Requesting compressor to turn OFF
F	There are no corresponding units.

[Outdoor unit – Control state] (Request code "51")

Data display	State
0 0 0 0	Normal
0 0 0 1	Preparing for heat operation
0 0 0 2	Defrost

[Compressor – Frequency control state] (Request code "52")

Data display

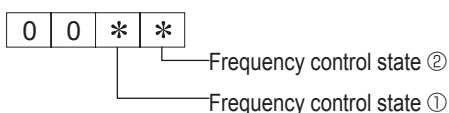

Frequency control state ①

Display	Current limit control
0	No current limit
1	Primary current limit control is ON.
2	Secondary current limit control is ON.

Frequency control state ②

Display	Discharge temperature overheat prevention	Condensation temperature overheat prevention	Anti-freeze protection control	Heat sink temperature overheat prevention
0				
1	Controlled			
2		Controlled		
3	Controlled	Controlled		
4			Controlled	
5	Controlled		Controlled	
6		Controlled	Controlled	
7	Controlled	Controlled	Controlled	
8				Controlled
9	Controlled			Controlled
A		Controlled		Controlled
b	Controlled	Controlled		Controlled
C			Controlled	Controlled
d	Controlled		Controlled	Controlled
E		Controlled	Controlled	Controlled
F	Controlled	Controlled	Controlled	Controlled

[Fan control state] (Request code "53")

Data display

0	0	*	*
---	---	---	---

└─ Fan step correction value by heat sink temperature overheating prevention control
└─ Fan step correction value by cool condensation temperature overheating prevention control

Display	Correction value
- (minus)	- 1
0	0
1	+1
2	+2

[Actuator output state] (Request code "54")

Data display

0	0	*	*
---	---	---	---

└─ Actuator output state ①
└─ Actuator output state ②

Actuator output state ①

Display	SV1	Four-way valve	Compressor	Compressor is warming up
0				
1	ON			
2		ON		
3	ON	ON		
4			ON	
5	ON		ON	
6		ON	ON	
7	ON	ON	ON	
8				ON
9	ON			ON
A		ON		ON
b	ON	ON		ON
C			ON	ON
d	ON		ON	ON
E		ON	ON	ON
F	ON	ON	ON	ON

Actuator output state ②

Display	52C	SV2	SS
0			
1	ON		
2		ON	
3	ON	ON	
4			ON
5	ON		ON
6		ON	ON
7	ON	ON	ON

[Error content (U9)] (Request code "55")

Data display

0	0	*	*
---	---	---	---

└─ Error content ①
└─ Error content ②

Error content ①

● : Detected

Display	Oversvoltage error	Undersvoltage error	L1-phase open error	Power synchronizing signal error
0				
1	●			
2		●		
3	●	●		
4			●	
5	●		●	
6		●	●	
7	●	●	●	
8				●
9	●			●
A		●		●
b	●	●		●
C			●	●
d	●		●	●
E		●	●	●
F	●	●	●	●

Error content ②

● : Detected

Display	Converter Fo error	PAM error
0		
1	●	
2		●
3	●	●

[Contact demand capacity] (Request code "61")

Data display

0	0	0	*
---	---	---	---

 Setting content

Setting content

Display	Setting value
0	0%
1	50%
2	75%
3	100%

[External input state] (Request code "62")

Data display

0	0	0	*
---	---	---	---

 Input state

Input state

● : Input present

Display	Contact demand input	Silent mode input	Spare 1 input	Spare 2 input
0				
1	●			
2		●		
3	●	●		
4			●	
5	●		●	
6		●	●	
7	●	●	●	
8				●
9	●			●
A		●		●
b	●	●		●
C			●	●
d	●		●	●
E		●	●	●
F	●	●	●	●

[Outdoor unit - Capacity setting display] (Request code "70")

Data display	Capacity
9	35
10	50
11	60
14	71
20	100
25	125
28	140
40	200
50	250

[Outdoor unit - Setting information] (Request code "71")

Data display

0	0	*	*
---	---	---	---

 Setting information ①
Setting information ②

Setting information ①

Display	Defrost mode
0	Standard
1	For high humidity

Setting information ②

Display	Single-/3-phase	Heat pump/cooling only
0	Single-phase	Heat pump
1		Cooling only
2	3-phase	Heat pump
3		Cooling only

[Outdoor unit switch setting display (SW1 to SW10, except SW3)] Request codes "73" to "82"

0: Switch OFF 1: Switch ON

SW1, SW2, SW6, SW7						Data display
1	2	3	4	5	6	
0	0	0	0	0	0	00 00
1	0	0	0	0	0	00 01
0	1	0	0	0	0	00 02
1	1	0	0	0	0	00 03
0	0	1	0	0	0	00 04
1	0	1	0	0	0	00 05
0	1	1	0	0	0	00 06
1	1	1	0	0	0	00 07
0	0	0	1	0	0	00 08
1	0	0	1	0	0	00 09
0	1	0	1	0	0	00 0A
1	1	0	1	0	0	00 0b
0	0	1	1	0	0	00 0C
1	0	1	1	0	0	00 0d
0	1	1	1	0	0	00 0E
1	1	1	1	0	0	00 0F
0	0	0	0	1	0	00 10
1	0	0	0	1	0	00 11
0	1	0	0	1	0	00 12
1	1	0	0	1	0	00 13
0	0	1	0	1	0	00 14
1	0	1	0	1	0	00 15
0	1	1	0	1	0	00 16
1	1	1	0	1	0	00 17
0	0	0	1	1	0	00 18
1	0	0	1	1	0	00 19
0	1	0	1	1	0	00 1A
1	1	0	1	1	0	00 1B
0	0	1	1	1	0	00 1C
1	0	1	1	1	0	00 1D
0	1	1	1	1	0	00 1E
1	1	1	1	1	0	00 1F
0	0	0	0	0	1	00 20
1	0	0	0	0	1	00 21
0	1	0	0	0	1	00 22
1	1	0	0	0	1	00 23
0	0	1	0	0	1	00 24
1	0	1	0	0	1	00 25
0	1	1	0	0	1	00 26
1	1	1	0	0	1	00 27
0	0	0	1	0	1	00 28
1	0	0	1	0	1	00 29
0	1	0	1	0	1	00 2A
1	1	0	1	0	1	00 2B
0	0	1	1	0	1	00 2C
1	0	1	1	0	1	00 2D
0	1	1	1	0	1	00 2E
1	1	1	1	0	1	00 2F
0	0	0	0	1	1	00 30
1	0	0	0	1	1	00 31
0	1	0	0	1	1	00 32
1	1	0	0	1	1	00 33
0	0	1	0	1	1	00 34
1	0	1	0	1	1	00 35
0	1	1	0	1	1	00 36
1	1	1	0	1	1	00 37
0	0	0	1	1	1	00 38
1	0	0	1	1	1	00 39
0	1	0	1	1	1	00 3A
1	1	0	1	1	1	00 3B
0	0	1	1	1	1	00 3C
1	0	1	1	1	1	00 3D
0	1	1	1	1	1	00 3E
1	1	1	1	1	1	00 3F

0: Switch OFF 1: Switch ON

SW5				Data display
1	2	3	4	
0	0	0	0	00 00
1	0	0	0	00 01
0	1	0	0	00 02
1	1	0	0	00 03
0	0	1	0	00 04
1	0	1	0	00 05
0	1	1	0	00 06
1	1	1	0	00 07
0	0	0	1	00 08
1	0	0	1	00 09
0	1	0	1	00 0A
1	1	0	1	00 0b
0	0	1	1	00 0C
1	0	1	1	00 0d
0	1	1	1	00 0E
1	1	1	1	00 0F

0: Switch OFF 1: Switch ON

SW8			Data display
1	2	3	
0	0	0	00 00
1	0	0	00 01
0	1	0	00 02
1	1	0	00 03
0	0	1	00 04
1	0	1	00 05
0	1	1	00 06
1	1	1	00 07

0: Switch OFF 1: Switch ON

SW4, SW9, SW10		Data display
1	2	
0	0	00 00
1	0	00 01
0	1	00 02
1	1	00 03

[Indoor unit – Model setting information] (Request code "162")

Data display

0 0 * *

See the table on the right.

Display	Model setting state	Display	Model setting state
00		20	
01		21	PKA-RP•FAL(2)
02		22	PLA-RP71-100BA2
03		23	
04		24	
05		25	
06		26	
07		27	
08		28	
09		29	
0A		2A	PLA-ZRP35-125BA
0b		2b	
0C		2C	
0d		2d	
0E		2E	
0F		2F	
10		30	
11		31	
12		32	
13		33	
14		34	PEAD-RP•JA(L)(Q)
15		35	
16		36	
17		37	PLA-RP100BA3, 140BA2
18		38	
19		39	
1A		3A	
1b		3b	
1C		3C	
1d		3d	
1E		3E	
1F		3F	

[Indoor unit – Capacity setting information] (Request code "163")

Data display

0 0 * *

See the table on the right.

Display	Capacity setting state	Display	Capacity setting state
00	12	10	112
01	16	11	125
02	22	12	140
03	25	13	
04	28	14	
05	32	15	
06	35, 36	16	
07	40	17	
08	45	18	
09	50	19	
0A	56	1A	
0b	63	1b	
0C	71	1C	
0d	80	1d	
0E	90	1E	
0F	100	1F	

[Wireless pair No. (indoor control board side) setting] (Request code "165")

Data display

0 0 * *

See the table on the right.

Display	Pair No. setting state
00	No. 0
01	No. 1 J41 disconnected
02	No. 2 J42 disconnected
03	No. 3 J41, J42 disconnected

13-1. SMOOTH MAINTENANCE

13-1-1. PAR-3xMAA ("x" represents 0 or later)

Maintenance data, such as the indoor/outdoor unit's heat exchanger temperature and compressor operation current can be displayed with "Smooth maintenance".

This cannot be executed during test operation.

Depending on the combination with the outdoor unit, this may not be supported by some models.

Select "Service" from the Main menu, and press the  button.



Select "Check" with the **F1** or **F2** button, and press the  button.



Select "Smooth maintenance" with the **F1** or **F2** button, and press the  button.

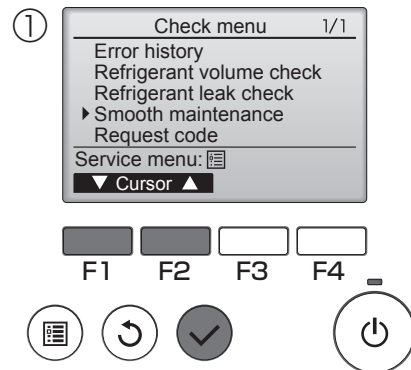

Set each item.

Select the item to be changed with the **F1** or **F2** button.

Select the required setting with the **F3** or **F4** button.

- <Ref.address>setting [0]~[15]
- <Stable mode>setting [Cool] / [Heat] / [Normal]

Press the  button, Fixed operation will start.

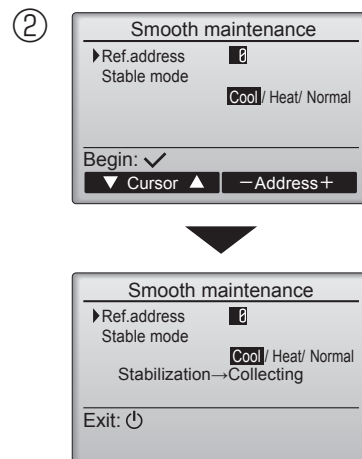

Note: Stable mode will take approx. 20 minutes.

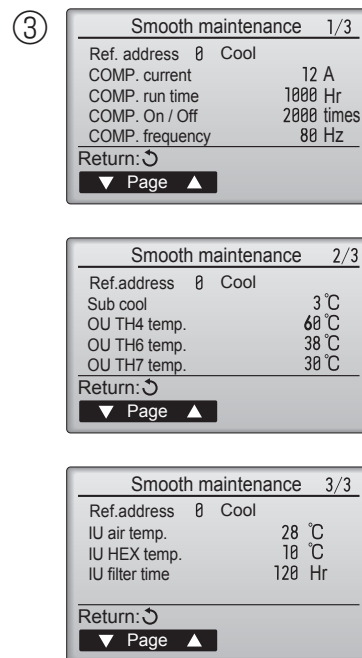

The operation data will appear.

The Compressor-Accumulated operating (COMP. run) time is 10-hour unit, and the Compressor-Number of operation times (COMP. ON/OFF) is a 100-time unit (fractions discarded).



- Navigating through the screens**
- To go back to the Service menu  button
 - To return to the previous screen  button

13-1-2. PAR-21MAA

- Reduces maintenance work drastically.
 - Enables you to check operation data of the indoor and outdoor units by remote controller.
- Furthermore, use of maintenance stable-operation control that fixes the operating frequency, allows smooth inspection, even for inverter models.

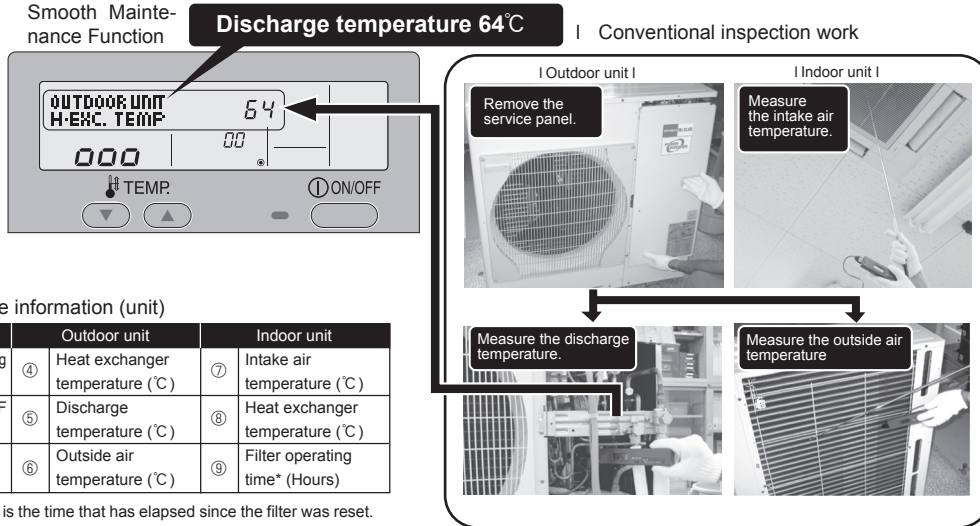

Easy maintenance information (unit)

Compressor		Outdoor unit		Indoor unit	
①	Accumulated operating time (×10 hours)	④	Heat exchanger temperature (°C)	⑦	Intake air temperature (°C)
②	Number of ON/OFF times (×10 times)	⑤	Discharge temperature (°C)	⑧	Heat exchanger temperature (°C)
③	Operating current (A)	⑥	Outside air temperature (°C)	⑨	Filter operating time* (Hours)

* The filter operating time is the time that has elapsed since the filter was reset.

13-2. MAINTENANCE MODE OPERATION METHOD

Note: If you are going to use 13-3. "GUIDE FOR OPERATION CONDITION", set the airflow to "High" before activating maintenance mode.

Switching to maintenance mode

Maintenance mode can be activated either when the air conditioner is operated or stopped.

It cannot be activated during test run.

* Maintenance information can be viewed even if the air conditioner is stopped.

Remote controller button information

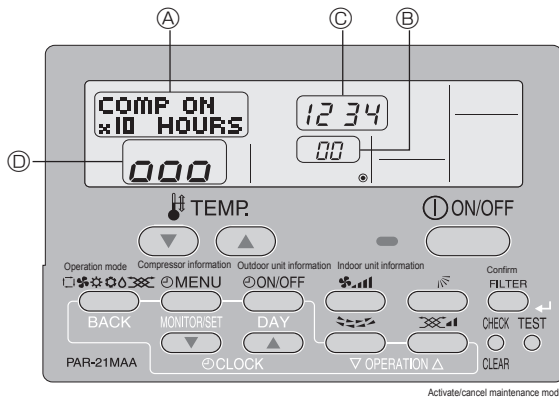

(1) Press the **TEST** button for 3 seconds to switch to maintenance mode.

[Display A] MAINTENANCE

If stable operation is unnecessary or if you want to check the data with the air conditioner stopped, skip to step (4).

Fixed Hz operation

The operating frequency can be fixed to stabilize operation of inverter model.

If the air conditioner is currently stopped, start it by this operation.

(2) Press the **MODE** button to select the desired operation mode.

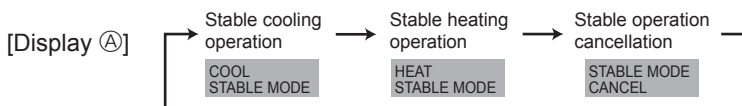

(3) Press the **FILTER** button to confirm the setting.

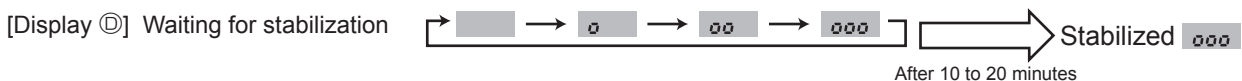

● **Data measurement**

When the operation is stabilized, measure operation data as explained below.

➤(4) Press the [TEMP] buttons ( and ) to select the desired refrigerant address.



➤(5) Select the type of data to be displayed.
After selecting, go to step (6).

Compressor information

 **MENU** button

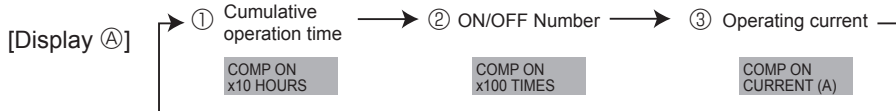

Outdoor unit information

 **ON/OFF** button

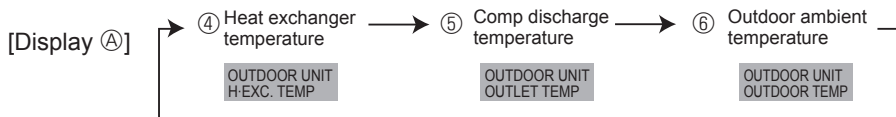

Indoor unit information

 **FILTER** button

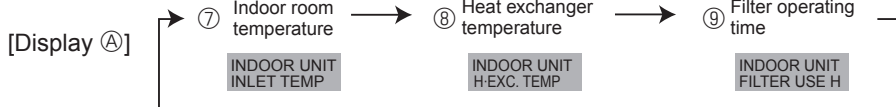

(6) Press the **FILTER** () button to confirm the setting.

[Display example for accumulated operating time]

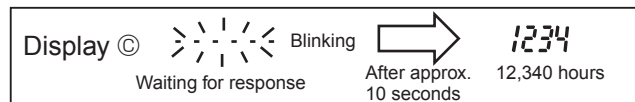

(7) Data is displayed on the display (at ⑤).

To check the data for each item, repeat steps (5) to (7).

(8) To cancel maintenance mode, press the **TEST** button for 3 seconds or press the  **ON/OFF** button.

■ **Refrigerant address**

Single refrigerant system

In the case of single refrigerant system, the refrigerant address is "00" and no operation is required. Simultaneous twin units belong to this category (single refrigerant system).

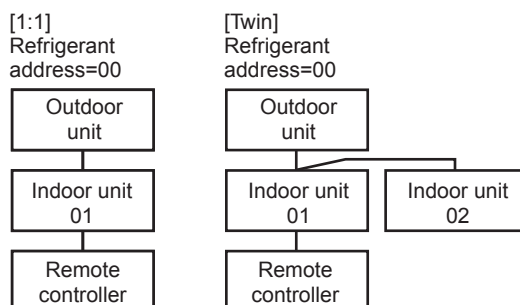

Multi refrigerant system (group control)

Up to 16 refrigerant systems (16 outdoor units) can be connected as a group by one remote controller. To check or set the refrigerant addresses.

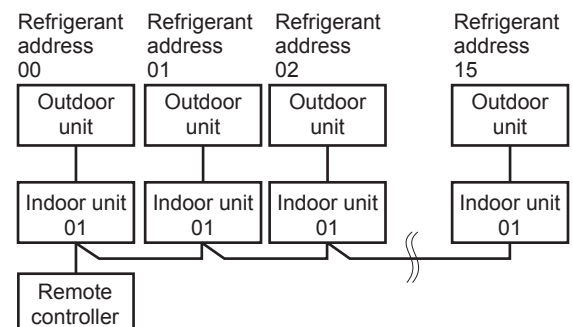

13-3. GUIDE FOR OPERATION CONDITION

Inspection item			Result			
Power supply	Loose connection	Breaker	Good	Retightened		
		Terminal block	Outdoor Unit	Good	Retightened	
			Indoor Unit	Good	Retightened	
		(Insulation resistance)		MΩ		
		(Voltage)		V		
Compressor		① Accumulated operating time		Time		
		② Number of ON/OFF times		Times		
		③ Current		A		
Outdoor Unit	Temperature	④ Refrigerant/heat exchanger temperature	COOL	°C	HEAT	°C
		⑤ Refrigerant/discharge temperature	COOL	°C	HEAT	°C
		⑥ Air/outside air temperature (Air/discharge temperature)	COOL	°C	HEAT	°C
	Cleanliness	Appearance	Good		Cleaning required	
		Heat exchanger	Good		Cleaning required	
		Sound/vibration	None		Present	
Indoor Unit	Temperature	⑦ Air/intake air temperature (Air/discharge temperature)	COOL	°C	HEAT	°C
		⑧ Refrigerant/heat exchanger temperature	COOL	°C	HEAT	°C
		⑨ Filter operating time*				Time
	Cleanliness	Decorative panel	Good		Cleaning required	
		Filter	Good		Cleaning required	
		Fan	Good		Cleaning required	
	Heat exchanger	Good		Cleaning required		
	Sound/vibration	None		Present		

* The filter operating time is the time that has elapsed since the filter was reset.

Check Points

Enter the temperature differences between ⑤, ④, ⑦ and ⑧ into the graph given below.

Operation state is determined according to the plotted areas on the graph.

For data measurements, set the fan speed to "Hi" before activating maintenance mode.

Classification	Item	Result		
Cool	Inspection	Is "D000" displayed stably on the remote controller?		
	Temperature difference	(⑤ Discharge temperature) – (④ Outdoor heat exchanger temperature)	Stable	Unstable
		(⑦ Indoor intake air temperature) – (⑧ Indoor heat exchanger temperature)		°C
Heat	Inspection	Is "D000" displayed stably on the remote controller?		
	Temperature difference	(⑤ Discharge temperature) – (⑧ Indoor heat exchanger temperature)	Stable	Unstable
		(⑧ Indoor heat exchanger temperature) – (⑦ Indoor intake air temperature)		°C

Note: 1. Fixed Hz operation may not be possible under the following temperature ranges.

A) In cool mode, outdoor intake air temperature is 40°C or high indoor intake air temperature is 23°C or lower.

B) In heat mode, outdoor intake air temperature is 20°C or high indoor intake air temperature is 25°C or lower.

2. If the air conditioner is operated at a temperature range other than the ones above but operation is not stabilized after 30 minutes or more elapsed, carry out inspection.

3. In heat mode, the operation state may vary due to frost forming on outdoor heat exchanger.

Area	Check item	Judgment	
		Cool	Heat
Normal	Normal operation state		
Filter inspection	Filter may be clogged. *		
Inspection A	Performance has dropped. Detailed inspection is necessary.		
Inspection B	Refrigerant amount is dropping.		
Inspection C	Filter or indoor heat exchanger may be clogged.		

Note: The above judgment is just guide based on Japanese standard conditions.

It may be changed depending on the indoor and outdoor temperature.

* It may be judged as "filter inspection" due to the outdoor and indoor temperature, even though it is not clogged.

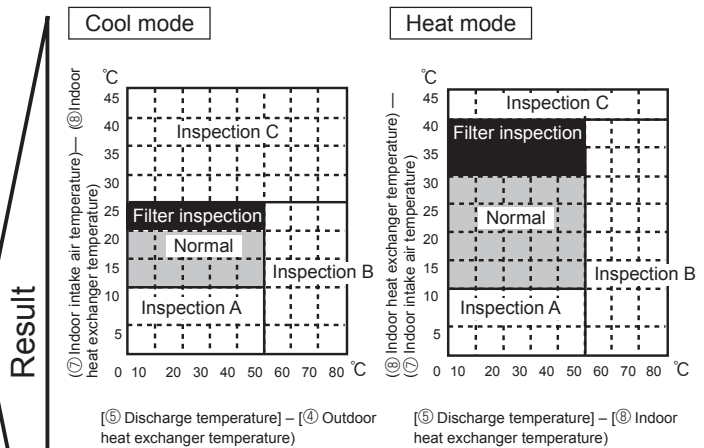

13-4. INITIAL SETTINGS FOR REFRIGERANT LEAKAGE DETECTION FUNCTION

13-4-1. PAR-3xMAA ("x" represents 0 or later)

Refrigerant leakage is detected after a long time.

To enable this function, the refrigerant volume must be saved (initial learning) after installation. Always operate this function in the following manner after installation.

- Always perform test run before using this function, and confirm that the air conditioner operates normally.
- To accurately detect refrigerant leaks, set the wind speed to strong, and execute this operation.

"Refrigerant leak check" is valid only with models which support the refrigerant leak check function.

① Select "Service" from the Main menu, and press the  button.



Select "Check" with the **F1** or **F2** button, and press the  button.



Select "Refrigerant leak check" with the **F1** or **F2** button, and press the  button.

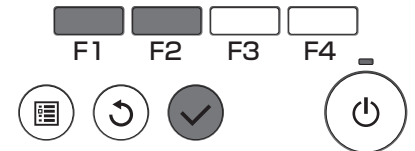
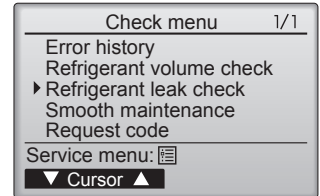

② Stable mode will start.

Press the  button, stable mode will start.

Stable mode will take approx. 20 minutes.

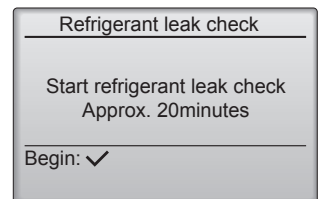

③ The operation data will appear.

The following value is the reference for the refrigerant volume check. If the refrigerant is leaking, "NG" will appear.

The refrigerant volume check reference value can be changed with the function selection.

Default value RP71 – : 80%
– RP50 : 70%

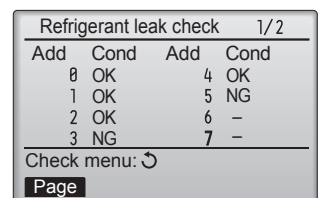

<Resetting the initial learning data>

If the unit has been relocated or if refrigerant has been additionally charged, the initial learning data must be reset and learning performed again.

How to reset the data:

1. Turn the main power OFF.
2. Attach the short-circuit pin for the emergency operation connector (CN31) on the outdoor controller board to the ON side.
3. Turn ON the test run switch (SW4-1) on the outdoor controller board.
4. The data will be reset when the main power is turned ON.
5. Turn the main power OFF.
6. Turn OFF the test run switch (SW4-1).
7. Return the short-circuit pin for the emergency operation connector (CN31) to the OFF side.

* Under the following conditions, it may not be possible to carry out stable operation or accurately detect refrigerant leaks.

- When the outdoor intake temperature is 40°C or higher, or when the indoor intake temperature is 23°C or less.
- When the indoor fan speed is not set to strong.

13-4-2. PAR-21MAA

■ Remote controller button position

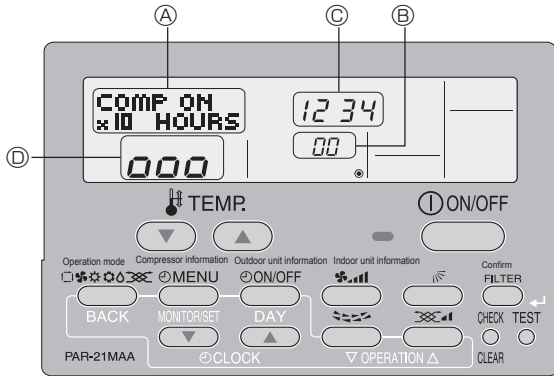

This air conditioner (Outdoor unit) can detect refrigerant leakage which may happen during a long period of use. In order to enable the leakage detection, the following settings are required to let the unit memorize the initial condition (initial refrigerant amount).

⚠ Caution :

Make sure to perform the "test run" and confirm the unit works without any problems, before starting the following setting. For more precise detection, make sure to set the airflow at "High notch" before enabling this setting.

[Display ①]



1. How to select the "Refrigerant Leakage Detection" mode

Detection is possible regardless the unit's operation (ON or OFF).

① Press **TEST** button for more than 3 seconds to switch to "EASY MAINTENANCE" mode. [Display ①]

2. How to start the initial learning

② Press **CLOCK** (▼) button and select the [GAS LEAK TEST START]

* The initial learning for the leakage detection is always done once after the new installation or the data reset.

[Display ②] Waiting for stabilization



After 45 minutes

③ Press **FILTER** (↔) button to confirm.

► How to finish the initial learning



Once the unit's operation is stabilized, the initial learning is completed.

④ Press **TEST** button for more than 3 seconds to cancel the initial learning. The initial learning can also be cancelled by pressing **ON/OFF** button.



3. How to start "Judgment of refrigerant leakage" mode.

To know the current condition of refrigerant amount, same operation must be performed.

Please repeat the same procedure ①~③ as when "Initial learning operation" for "Checking operation".

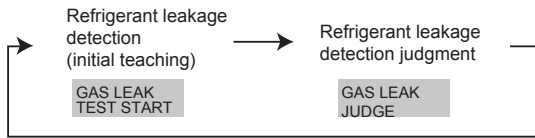
④ Press  CLOCK  button and select the [GAS LEAK JUDGE]



⑤ Press  (←) button to confirm. (Display  LOADING)

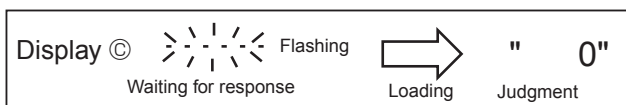

Display[C] indication	Meaning (% setting)
" 0 "	Refrigerant leakage is less than 20% of initial condition.
" 20 "	Refrigerant leakage is more than 20% of initial condition.
" 8888 "	"Error"=No initial data is available.

<Note>

% for judgment can be changed by "Unit function setting of remote controller".

Selectable either 80%(initial setting) or 60%

Refer to "Mode No.21" on <Table 1> Function selections in ch.11-1.

(When the "%" for judgment is changed, please start "Initial learning ①~③" about 1 minute (③) and cancel ④.)

Then, please start "Judgment of refrigerant leakage" mode(①~⑤).

<How to reset the initial condition (data) >

When the unit is removed and installed again or refrigerant is charged additionally, the "Initial learning" must be performed again by following procedure.

(1)Turn "Main Power" OFF.

(2)Connect the pin of CN31 to ON position on the outdoor controller board.

(3)Turn SW4-1 on the outdoor controller board to ON.

(4)Turn "Main Power" ON to reset the initial data.

After reset the data, please turn pin of CN31 and SW4-1 to original(OFF) position.

<Caution>

1.On the following condition, the operation cannot be stabilized and judgment of checking operation may not be accurate.

(a)Outdoor temperature $\geq 40^{\circ}\text{C}$ or Room temperature $\leq 23^{\circ}\text{C}$

(b)Air flow setting is not "High-notch".

2.Please check the operation and unit status, when the operation is not stabilized after more than 45 minutes.

PUHZ-SHW80VHA

PUHZ-SHW80VHAR2.UK

PUHZ-SHW80VHAR3.UK

PUHZ-SHW80VHAR4.UK

PUHZ-SHW80VHAR2-BS.UK

PUHZ-SHW80VHAR3-BS.UK

PUHZ-SHW80VHAR4-BS.UK

PUHZ-SHW112VHA

PUHZ-SHW112VHAR2.UK

PUHZ-SHW112VHAR3.UK

PUHZ-SHW112VHAR4.UK

PUHZ-SHW112VHAR2-BS.UK

PUHZ-SHW112VHAR3-BS.UK

PUHZ-SHW112VHAR4-BS.UK

OPERATING PROCEDURE

PHOTOS/FIGURES

- 1. Removing the service panel and top panel**
- (1) Remove 3 service panel fixing screws (5 × 12) and slide the hook on the right downward to remove the service panel.
 - (2) Remove screws (2 for front, 3 for rear/5 × 12) of the top panel and remove it.

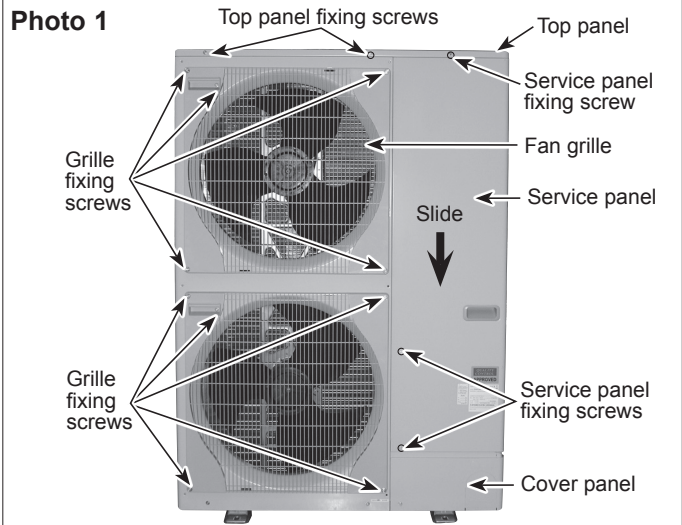

- 2. Removing the fan motor (MF1, MF2)**
- (1) Remove the service panel. (See Photo 1)
 - (2) Remove the top panel. (See Photo 1)
 - (3) Remove 5 fan grille fixing screws (5 × 12) to detach the fan grille. (Top and bottom) (See Photo 1)
 - (4) Remove a nut (for right handed screw of M6) to detach the propeller. (Top and bottom) (See Photo 2-1)
 - (5) Disconnect the connectors, CNF1, CNF2 on controller circuit board in electrical parts box.
 - (6) Remove 4 fan motor fixing screws (5 × 20) to detach the fan motor. (Top and bottom) (See Photo 2-2)
 - (7) Loosen the clamp for lead wires on the motor support.
- Note:** Due to a parts-sharing, the fan motor for service has longer lead wires. Upon replacement, tie up any excessive lead wires in a bundle, then fix it with a clamp in the electrical parts box.

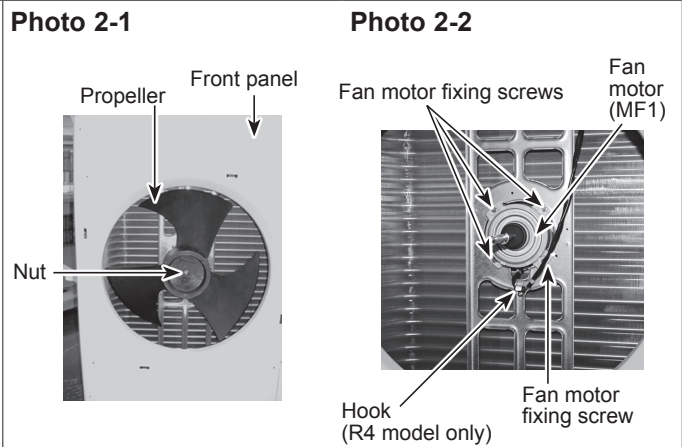

- 3. Removing the electrical parts box**
- (1) Remove the service panel. (See Photo 1)
 - (2) Remove the top panel. (See Photo 1)
 - (3) Disconnect the indoor/outdoor connecting wire and the power supply wire from terminal block.
 - (4) Disconnect the connector CNF1, CNF2, LEV-A, LEV-B and LEV-C on the controller circuit board.
<Symbols on the board>
 - CNF1, CNF2 : Fan motor
 - LEV-A, LEV-B, LEV-C : LEV
 - (5) Disconnect the pipe-side connections of the following parts.
 - Thermistor <Liquid>(TH3)
 - Thermistor <Discharge>(TH4)
 - Thermistor <2-phase pipe>(TH6)
 - Thermistor <Ambient>(TH7)
 - Thermistor <Suction> (TH32)
 - Thermistor <Ref. check> (TH33)
 - Thermistor <Comp. surface> (TH34)
 - High pressure switch (63H)
 - Low pressure switch (63L)
 - High pressure sensor (63HS)
 - 4-way valve coil (21S4)
 - (6) Remove the terminal cover and disconnect the compressor lead wire.
 - (7) Loosen the clamp for lead wires on the separator.
 - (8) Remove 2 electrical parts box fixing screws (4 × 10) and detach the electrical parts box by pulling it upward. The electrical parts box is fixed with 2 hooks on the left and 1 hook on the right.

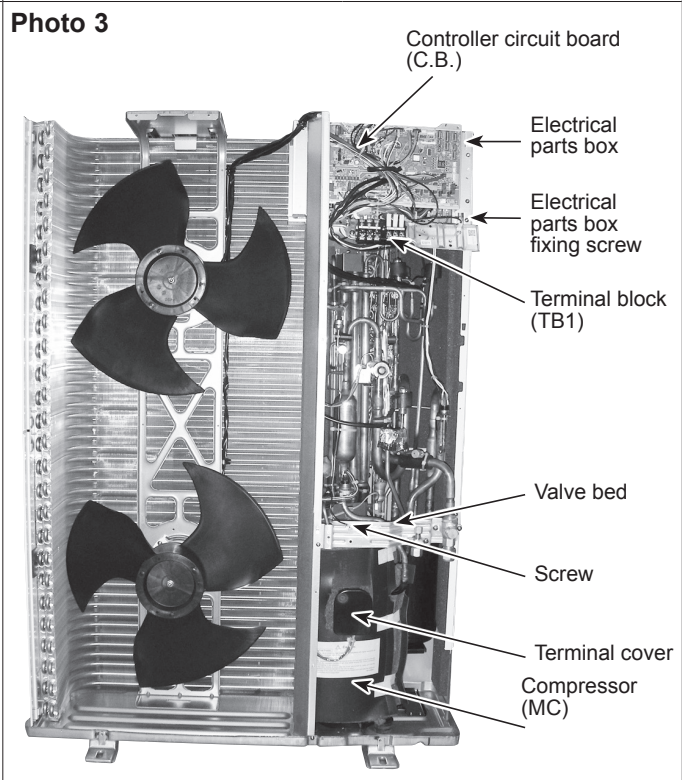

OPERATING PROCEDURE

4. Removing the thermistor <2-phase pipe> (TH6) and thermistor <Ambient>(TH7)

- (1) Remove the service panel. (See Photo 1)
- (2) Remove the top panel. (See Photo 1)
- (3) Disconnect the connectors TH7/6 (red) on the controller circuit board in the electrical parts box.
Loosen 3 fasteners for lead wires in the electrical parts box.
- (4) Loosen the cable strap for lead wires in the rear of the electrical parts box.
- (5) Pull out the thermistor <2-phase pipe> (TH6) and thermistor <Ambient> (TH7) from the sensor holder.

Note: When replacing thermistor <2-phase pipe> (TH6) or thermistor <Ambient> (TH7), replace it together.

PHOTOS/FIGURES

Photo 4-1

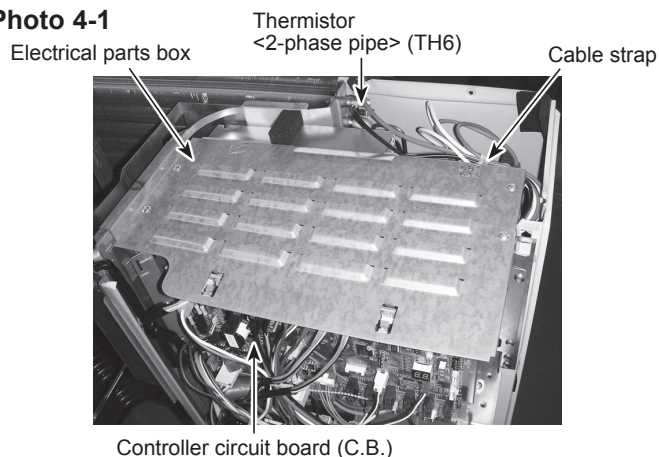
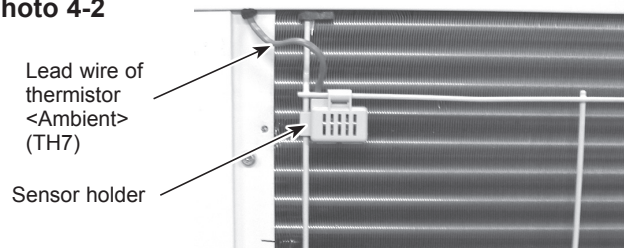

Photo 4-2



5. Removing the thermistor <Discharge> (TH4) and thermistor <Comp. surface> (TH34)

- (1) Remove the service panel. (See Photo 1)
- (2) Disconnect the connector TH4 (white) and TH34 (red) on the controller circuit board in the electrical parts box.
- (3) Loosen clamps for lead wires on the separator. (See Photo 5)
Loosen 3 fasteners and the cable strap for lead wires in the electrical parts box.
- (4) Pull out the thermistor <Discharge> (TH4) from the sensor holder.

[Removing the thermistor<Comp. surface> (TH34)]

- (5) Remove the sound proof cover (upper) for compressor.
- (6) Pull out the thermistor <Comp. surface> (TH34) from the holder of the compressor shell.

Photo 5

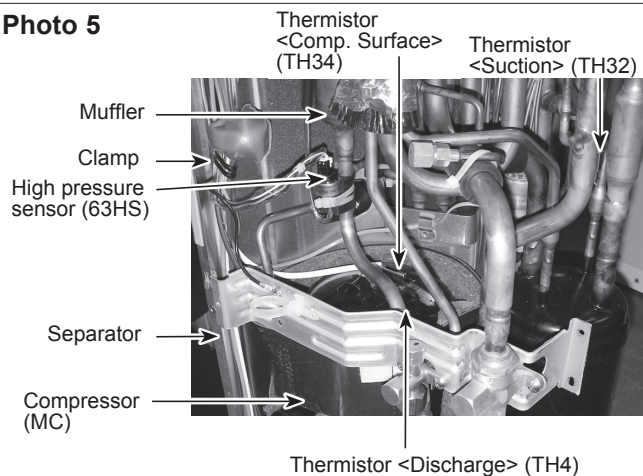

6. Removing the thermistor <Liquid> (TH3), thermistor <Suction> (TH32) and thermistor <Ref. check> (TH33)

- (1) Remove the service panel. (See Photo 1)
- (2) Disconnect the connectors, TH3 (white) and TH32 (black), TH33 (yellow) on the controller circuit board in the electrical parts box.
- (3) Loosen clamps for lead wires on the separator (See Photo 5).
Loosen 3 fasteners and the cable strap for lead wires in the electrical parts box.
- (4) Loosen clamp for the lead wire for TH3.
- (5) Pull out the thermistor <Liquid> (TH3), thermistor <Suction> (TH32) and thermistor <Ref. check> (TH33) from the sensor holder.
(TH32 : See Photo 5)
(TH33 : See Photo 7)

Photo 6

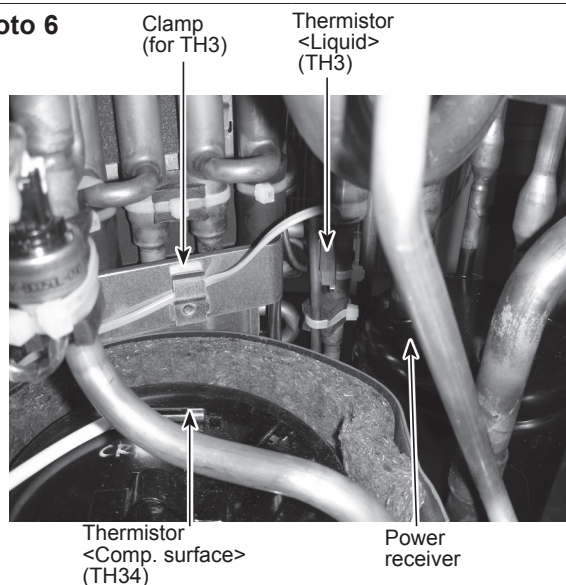

OPERATING PROCEDURE

7. Removing the 4-way valve coil (21S4), and linear expansion valve coil (LEV-A, LEV-B, LEV-C)

- (1) Remove the service panel. (See Photo 1)
- (2) Remove the top panel. (See Photo 1)

[Removing the 4-way valve coil]

- (3) Remove 4-way valve coil fixing screw (M5 × 6).
- (4) Remove the 4-way valve coil by sliding the coil toward you. Loosen the clamp for lead wires on the separator. Loosen a fastener and the cable strap for lead wires in the electrical parts box.
- (5) Disconnect the connector 21S4 (green) on the controller circuit board in the electrical parts box.

[Removing the linear expansion valve coil]

- (3) Remove the linear expansion valve coil by sliding the coil upward. Loosen the clamp for lead wires on the separator.
- (4) Disconnect the connectors, LEV-A (white), LEV-B (red) and LEV-C (blue) on the controller circuit board in the electrical parts box.

8. Removing the 4-way valve

- (1) Remove the service panel. (See Photo 1)
- (2) Remove the top panel. (See Photo 1)
- (3) Remove 3 valve bed fixing screws (4 × 10) and 4 ball valve and stop valve fixing screws (5 × 16) then remove the valve bed.
- (4) Remove 5 side panel (R) fixing screws (5 × 12) in the rear of the unit then remove the side panel (R).
- (5) Remove the 4-way valve coil.
- (6) Recover refrigerant.
- (7) Remove the welded part of 4-way valve.

Note: When installing the 4-way valve, cover it with a wet cloth to prevent it from heating (120°C or more), then braze the pipes so that the inside of pipes are not oxidized.

9. Removing linear expansion valve

- (1) Remove the service panel. (See Photo 1)
- (2) Remove the top panel. (See Photo 1)
- (3) Remove the valve bed. (Refer to procedure 8)
- (4) Remove the side panel (R). (Refer to procedure 8)
- (5) Remove the linear expansion valve coil.
- (6) Recover refrigerant.
- (7) Remove the welded part of linear expansion valve.

Note: When installing the linear expansion valve, cover it with a wet cloth to prevent it from heating (120°C or more), then braze the pipes so that the inside of pipes are not oxidized.

10. Removing the high pressure switch (63H), the low pressure switch (63L) and the pressure sensor (63HS)

- (1) Remove the service panel. (See Photo 1)
- (2) Remove the top panel. (See Photo 1)
- (3) Remove the valve bed. (Refer to procedure 8)
- (4) Remove the side panel (R). (Refer to procedure 8)
- (5) Pull out the lead wire of high pressure switch and low pressure switch.
- (6) Recover refrigerant.
- (7) Remove the welded part of high pressure switch, low pressure switch, and the pressure sensor (63HS).

Note: When installing the high pressure switch, cover it with a wet cloth to prevent it from heating (100°C or more), then braze the pipes so that the inside of pipes are not oxidized.

PHOTOS/FIGURES

Photo 7-1

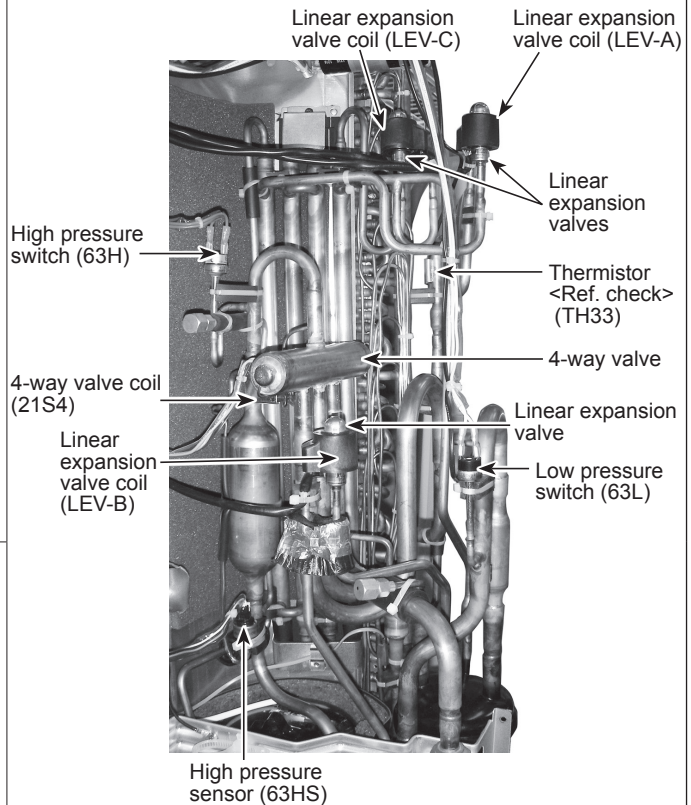
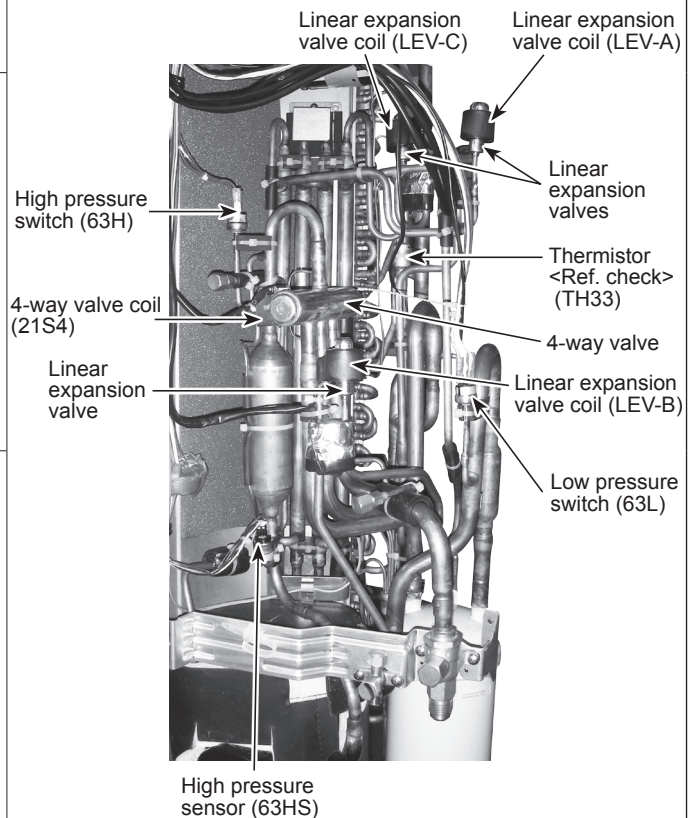

Photo 7-2: VHAR2 type



Note 1: Recover refrigerant without spreading it in the air.

Note 2: The welded part can be removed easily by removing the right side panel.

OPERATING PROCEDURE

11. Removing the reactor (DCL) and capacitor (CB)*

- (1) Remove the service panel. (See Photo 1)
- (2) Remove the top panel. (See Photo 1)
- (3) Remove the electrical parts box. (See Photo 3)

[Removing the reactor]

- (4) Remove 4 reactor fixing screws (4 × 10) and remove the reactor.

[Removing the capacitor] (Only for VHA(R1–R3) model)

- (4) Remove 4 capacitor band fixing screws (4 × 10) and remove the capacitor.

Note: The reactor and capacitor are attached to the rear of the electrical parts box.

*Capacitor is not equipped for VHAR4 models.

PHOTOS/FIGURES

Photo 8

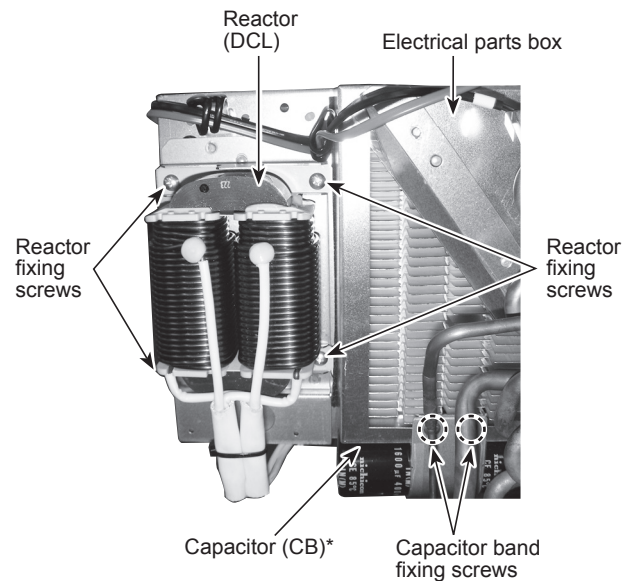

12. Removing the compressor (MC)

- (1) Remove the service panel. (See Photo 1)
- (2) Remove the top panel. (See Photo 1)
- (3) Remove 2 cover panel (front) fixing screws (5 × 12) and remove the front cover panel. (See Photo 1)
- (4) Remove 2 cover panel (rear) fixing screws (5 × 12) and remove the back cover panel.
- (5) Remove the electrical parts box. (See Photo 3)
- (6) Remove the valve bed. (Refer to procedure 8)
- (7) Remove the side panel (R). (Refer to procedure 8)
- (8) Remove the electrical parts box. (See Photo 3)
- (9) Remove 3 separator fixing screws (4 × 10) and remove the separator.
- (10) Remove the soundproof cover for compressor.
- (11) Recover refrigerant.
- (12) Remove the welded pipe of compressor inlet and outlet then remove the compressor.
- (13) Remove the 3 points of the compressor fixing nut using a spanner or an adjustable wrench.

Note: Recover refrigerant without spreading it in the air.

Photo 9

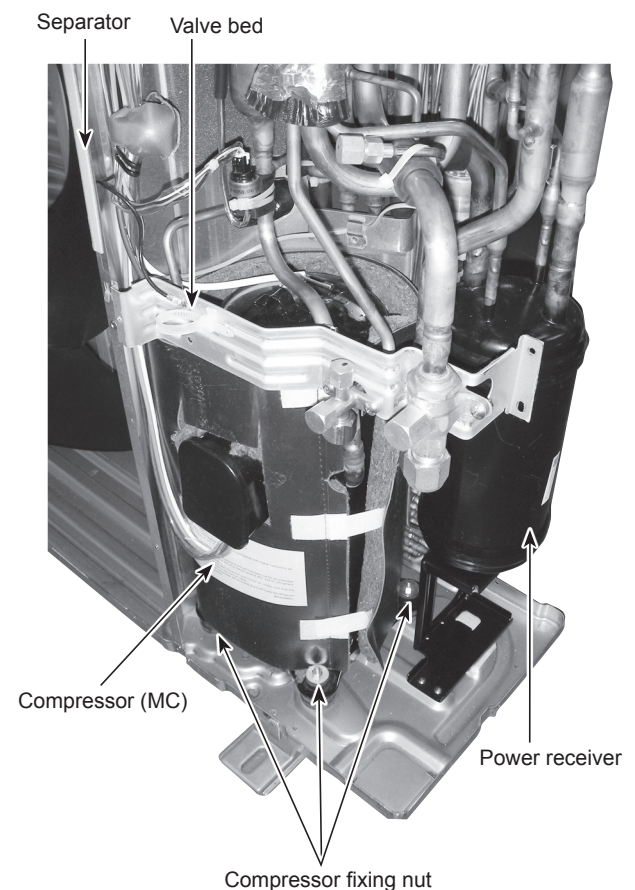

OPERATING PROCEDURE

13. Removing the power receiver

- (1) Remove the service panel. (See Photo 1)
- (2) Remove the top panel. (See Photo 1)
- (3) Remove the cover panel (front). (Refer to procedure 12)
- (4) Remove the cover panel (rear). (Refer to procedure 12)
- (5) Remove the electrical parts box. (See Photo 3)
- (6) Remove the valve bed. (Refer to procedure 8)
- (7) Remove the side panel (R). (Refer to procedure 8)
- (8) Recover refrigerant.
- (9) Remove 4 welded pipes of power receiver inlet and outlet.
- (10) Remove 2 receiver leg fixing screws (4 × 10).

Note: Recover refrigerant without spreading it in the air.

PHOTOS/FIGURES

Photo 10

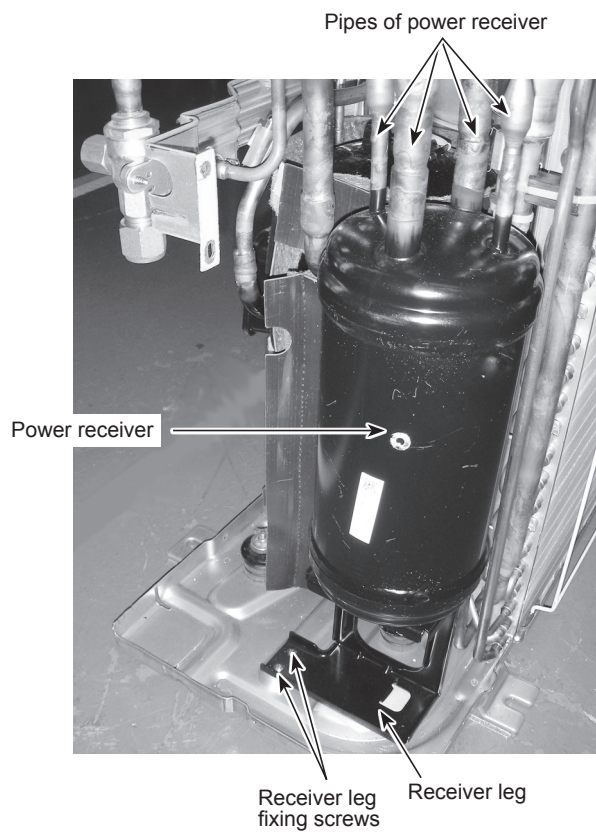

PUHZ-SHW112YHA
 PUHZ-SHW112YHAR1
 PUHZ-SHW140YHA
 PUHZ-SHW140YHAR1

PUHZ-SHW112YHAR2.UK
 PUHZ-SHW112YHAR2-BS.UK
 PUHZ-SHW140YHAR2.UK
 PUHZ-SHW140YHAR2-BS.UK

PUHZ-SHW112YHAR3.UK
 PUHZ-SHW112YHAR3-BS.UK
 PUHZ-SHW140YHAR3.UK
 PUHZ-SHW140YHAR3-BS.UK

PUHZ-SHW112YHAR4.UK
 PUHZ-SHW112YHAR4-BS.UK
 PUHZ-SHW140YHAR4.UK
 PUHZ-SHW140YHAR4-BS.UK
 PUHZ-SHW140YHAR5.UK
 PUHZ-SHW140YHAR5-BS.UK

OPERATING PROCEDURE	PHOTOS/FIGURES
<p>1. Removing the service panel and top panel</p> <ol style="list-style-type: none"> Remove 3 service panel fixing screws (5 × 12) and slide the hook on the right downward to remove the service panel. Remove screws (2 for front, 3 for rear/5 × 12) of the top panel and remove it. 	<p>Photo 1</p>
<p>2. Removing the fan motor (MF1, MF2)</p> <ol style="list-style-type: none"> Remove the service panel. (See Photo 1) Remove the top panel. (See Photo 1) Remove 5 fan grille fixing screws (5 × 12) to detach the fan grille. (Top and bottom) (See Photo 1) Remove a nut (for right handed screw of M6) to detach the propeller. (Top and bottom) (See Photo 2-1) Disconnect the connectors, CNF1, CNF2 on controller circuit board in electrical parts box. Remove 4 fan motor fixing screws (5 × 20) to detach the fan motor. (Top and bottom) (See Photo 2-2) Loosen the clamp for lead wires on the motor support. <p>Note: Due to a parts-sharing, the fan motor for service has longer lead wires. Upon replacement, tie up any excessive lead wires in a bundle, then fix it with a clamp in the electrical parts box.</p>	<p>Photo 2-1</p> <p>Photo 2-2</p>
<p>3. Removing the electrical parts box</p> <ol style="list-style-type: none"> Remove the service panel. (See Photo 1) Remove the top panel. (See Photo 1) Disconnect the indoor/outdoor connecting wire and the power supply wire from terminal block. Disconnect the connector CNF1, CNF2, LEV-A, LEV-B and LEV-C on the controller circuit board. <Symbols on the board> <ul style="list-style-type: none"> • CNF1, CNF2 : Fan motor • LEV-A, LEV-B, LEV-C : LEV Disconnect the pipe-side connections of the following parts. <ul style="list-style-type: none"> • Thermistor <Liquid>(TH3) • Thermistor <Discharge>(TH4) • Thermistor <2-phase pipe>(TH6) • Thermistor <Ambient>(TH7) • Thermistor <Suction> (TH32) • Thermistor <Ref. check> (TH33) • Thermistor <Comp. surface> (TH34) • High pressure switch (63H) • Low pressure switch (63L) • High pressure sensor (63HS) • 4-way valve coil (21S4) • Reactors (ACL1, ACL2, ACL3) Remove the terminal cover and disconnect the compressor lead wire. Loosen the clamp for lead wires on the separator. Remove 2 electrical parts box fixing screws (4 × 10) and detach the electrical parts box by pulling it upward. The electrical parts box is fixed with 2 hooks on the left and 1 hook on the right. 	<p>Photo 3</p>

OPERATING PROCEDURE

4. Disassembling the electrical parts box

- (1) Disconnect all the connectors on the controller circuit board.
- (2) Remove the 3 screws, screw ①, ② and ③, that fix the plate equipped with the outdoor controller circuit board, and the electrical parts box, screw ① from the front and the screw ② and ③ from the bottom of the electrical parts box. (See Photo 4-1 and 4-2)
- (3) Slide the plate in the direction of the arrow A and remove it. (See Photo 4-1)
- (4) Remove the lead wires from the clamp and the wire clip on the bottom of the electrical parts box. (See Photo 4-3)
- (5) Remove the 3 screws, screw ④ and ⑤, that fix the bottom side of the electrical parts box and remove the bottom side plate by sliding in the direction of the arrow B. (See Photo 4-3 and 4-4)
- (6) Remove the noise filter circuit board from the electrical parts box. Then remove the 2 screws, screw ⑥ and ⑦, that fix the plate equipped with the noise filter circuit board and converter circuit board. (See Photo 4-5)

Note: When reassembling the electrical parts box, make sure the wirings are correct.

PHOTOS/FIGURES

Photo 4-1

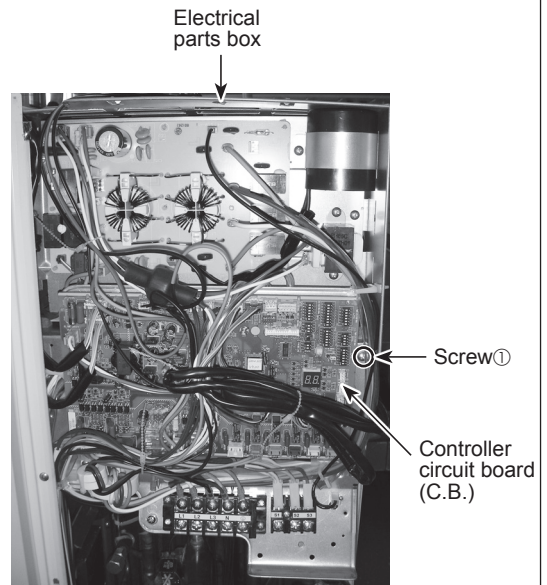

A ⇒

Photo 4-2

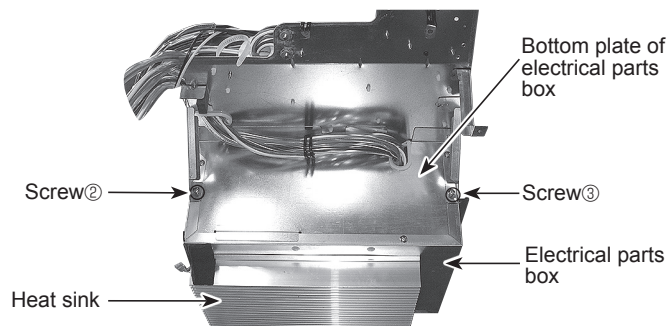

Photo 4-3

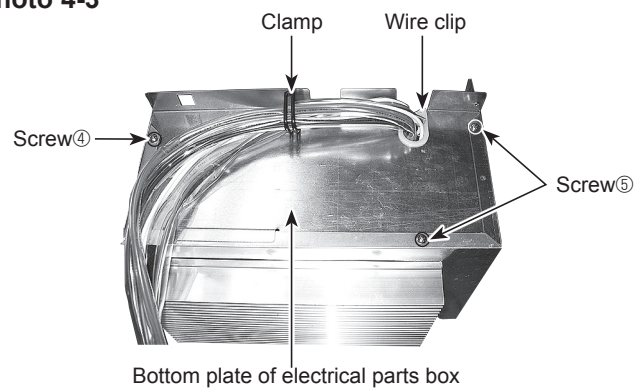

Photo 4-4

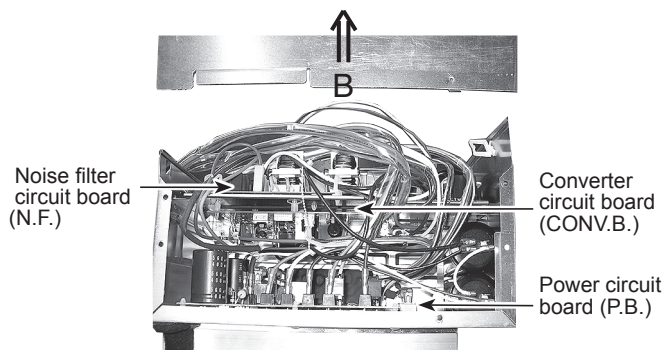
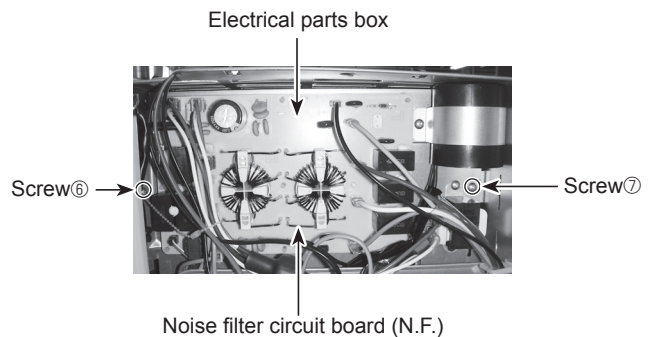

Photo 4-5



OPERATING PROCEDURE

5. Removing the thermistor <2-phase pipe> (TH6) and thermistor <Ambient>(TH7)

- (1) Remove the service panel. (See Photo 1)
- (2) Remove the top panel. (See Photo 1)
- (3) Disconnect the connectors TH7/6 (red) on the controller circuit board in the electrical parts box. Loosen a fastener for lead wires in the electrical parts box.
- (4) Loosen the clamp for lead wires in the rear of the electrical parts box.
- (5) Pull out the thermistor <2-phase pipe> (TH6) and thermistor <Ambient> (TH7) from the sensor holder.

Note: When replacing thermistor <2-phase pipe> (TH6) or thermistor <Ambient> (TH7), replace it together.

PHOTOS/FIGURES

Photo 5-1

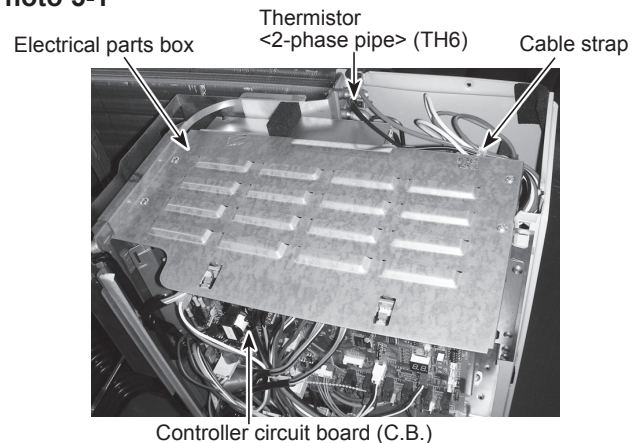
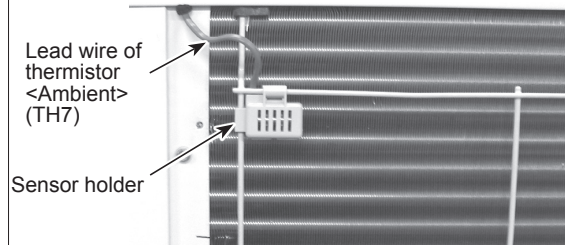

Photo 5-2



6. Removing the thermistor <Discharge> (TH4) and thermistor <Comp. surface> (TH34)

- (1) Remove the service panel. (See Photo 1)
- (2) Disconnect the connector TH4 (white) and TH34 (red) on the controller circuit board in the electrical parts box.
- (3) Loosen clamps for lead wires on the separator. (See Photo 6)
- (4) Loosen 3 fasteners and the cable strap for lead wires in the electrical parts box.
- (5) Pull out the thermistor <Discharge> (TH4) from the sensor holder.

[Removing the thermistor<Comp. surface> (TH34)]

- (5) Remove the sound proof cover (upper) for compressor.
- (6) Pull out the thermistor <Comp. surface> (TH34) from the holder of the compressor shell.

Photo 6

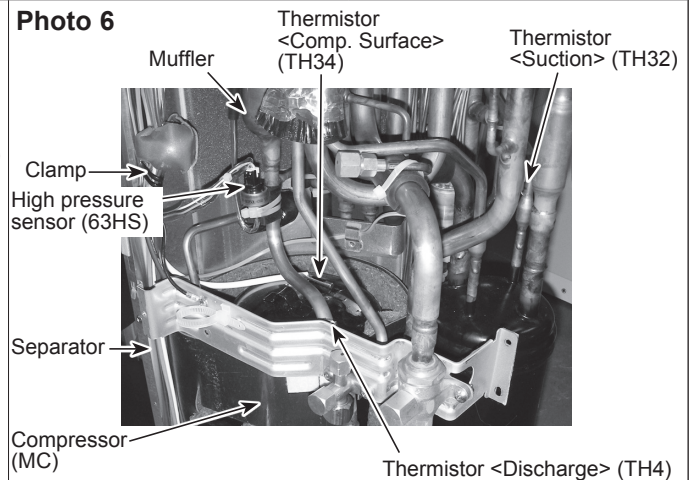

7. Removing the thermistor <Liquid> (TH3), thermistor <Suction> (TH32) and thermistor <Ref. check> (TH33)

- (1) Remove the service panel. (See Photo 1)
 - (2) Disconnect the connectors, TH3 (white) and TH32 (black), TH33 (yellow) on the controller circuit board in the electrical parts box.
 - (3) Loosen clamps for lead wires on the separator. (See Photo 6)
 - (4) Loosen 3 fasteners and the cable strap for lead wires in the electrical parts box.
 - (5) Loosen clamp for the lead wire for TH3.
 - (6) Pull out the thermistor <Liquid> (TH3), thermistor <Suction> (TH32) and thermistor <Ref. check> (TH33) from the sensor holder.
- (TH32 : See Photo 6)
(TH33 : See Photo 8)

Photo 7

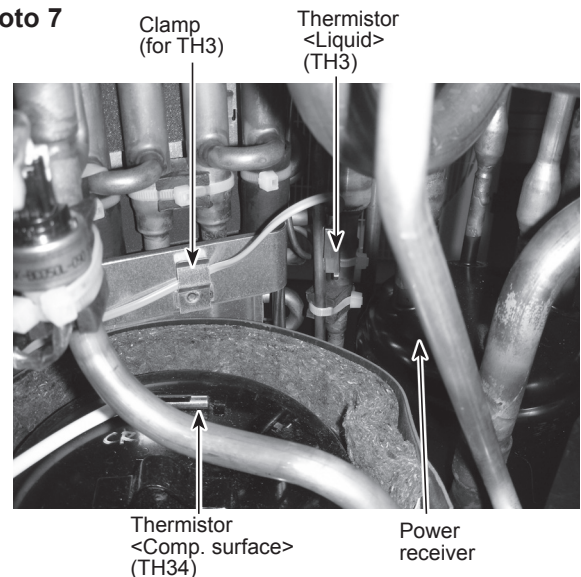

OPERATING PROCEDURE

8. Removing the 4-way valve coil (21S4), and linear expansion valve coil (LEV-A, LEV-B, LEV-C)

- (1) Remove the service panel. (See Photo 1)
- (2) Remove the top panel. (See Photo 1)

[Removing the 4-way valve coil]

- (3) Remove 4-way valve coil fixing screw (M5 × 6).
- (4) Remove the 4-way valve coil by sliding the coil toward you. Loosen the clamp for lead wires on the separator. Loosen 2 fasteners and the cable strap for lead wires in the electrical parts box.
- (5) Disconnect the connector 21S4 (green) on the controller circuit board in the electrical parts box.

[Removing the linear expansion valve coil]

- (3) Remove the linear expansion valve coil by sliding the coil upward.
- Loosen the clamp for lead wires on the separator.
- (4) Disconnect the connectors, LEV-A (white), LEV-B (red) and LEV-C (blue) on the controller circuit board in the electrical parts box.

9. Removing the 4-way valve

- (1) Remove the service panel. (See Photo 1)
- (2) Remove the top panel. (See Photo 1)
- (3) Remove 3 valve bed fixing screws (4 × 10) and 4 ball valve and stop valve fixing screws (5 × 16) then remove the valve bed.
- (4) Remove 5 side panel (R) fixing screws (5 × 12) in the rear of the unit then remove the side panel (R).
- (5) Remove the 4-way valve coil.
- (6) Recover refrigerant.
- (7) Remove the welded part of 4-way valve.

Note : When installing the 4-way valve, cover it with a wet cloth to prevent it from heating (120°C or more), then braze the pipes so that the inside of pipes are not oxidized.

10. Removing linear expansion valve

- (1) Remove the service panel. (See Photo 1)
- (2) Remove the top panel. (See Photo 1)
- (3) Remove the valve bed. (Refer to procedure 9)
- (4) Remove the side panel (R). (Refer to procedure 9)
- (5) Remove the linear expansion valve coil.
- (6) Recover refrigerant.
- (7) Remove the welded part of linear expansion valve.

Note : When installing the linear expansion valve, cover it with a wet cloth to prevent it from heating (120°C or more), then braze the pipes so that the inside of pipes are not oxidized.

11. Removing the high pressure switch (63H), the low pressure switch (63L) and the pressure sensor (63HS)

- (1) Remove the service panel. (See Photo 1)
- (2) Remove the top panel. (See Photo 1)
- (3) Remove the valve bed. (Refer to procedure 9)
- (4) Remove the side panel (R). (Refer to procedure 9)
- (5) Pull out the lead wire of high pressure switch and low pressure switch.
- (6) Recover refrigerant.
- (7) Remove the welded part of high pressure switch, low pressure switch, and the pressure sensor (63HS).

Note : When installing the high pressure switch, cover it with a wet cloth to prevent it from heating (100°C or more), then braze the pipes so that the inside of pipes are not oxidized.

PHOTOS/FIGURES

Photo 8-1

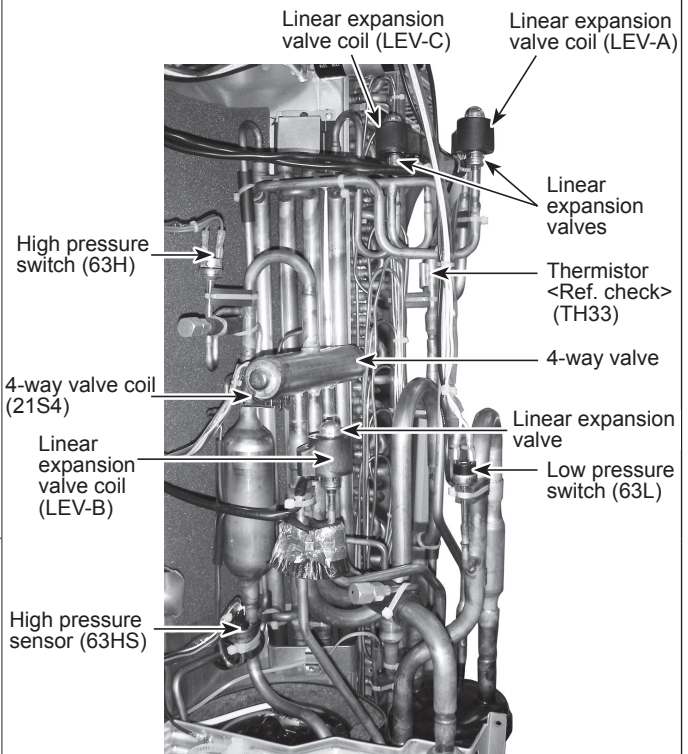
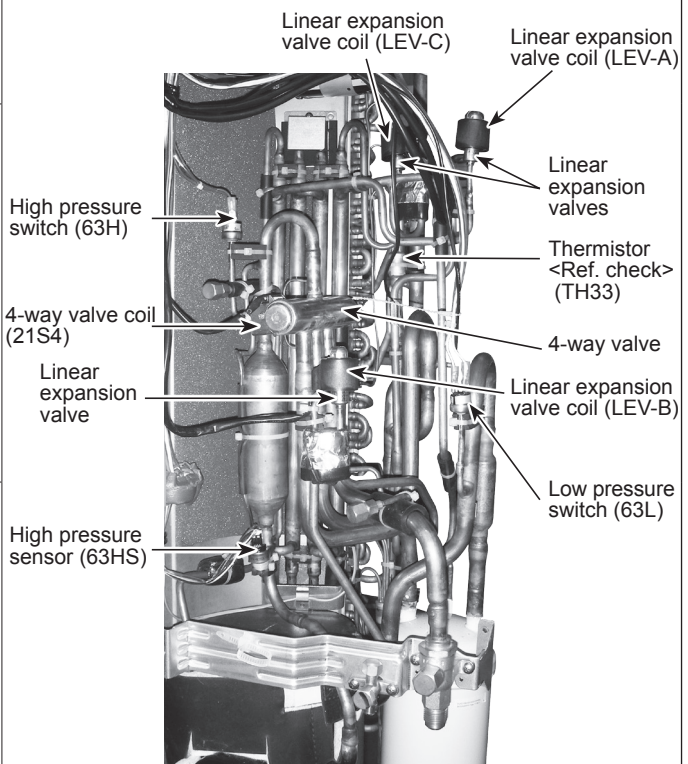

Photo 8-2: YHAR2 type



Note 1: Recover refrigerant without spreading it in the air.

Note 2: The welded part can be removed easily by removing the right side panel.

OPERATING PROCEDURE

12. Removing the reactors (ACL1, ACL2, ACL3)

- (1) Remove the service panel. (See Photo 1)
- (2) Remove the top panel. (See Photo 1)
- (3) Remove the 6 screws, that fix the front panel and remove the front panel.
- (4) Remove the 2 screws, screw ⑧ and ⑨ (both 4 × 10), that fix the separator, screw ⑧ from the valve bed and screw ⑨ from the bottom of the separator, and tilt the separator to the side of the fan motor slightly. (See Photo 12-1)
- (5) Disconnect the lead wires from the reactor and remove the 4 screws, screw ⑩, that fix the reactor to remove the reactor. (See photo 12-3.)

Note 1: The reactor is very heavy (4kg)!

Be careful when handling it.

Note 2: The reactor box is also removable.

Photo 12-2-1

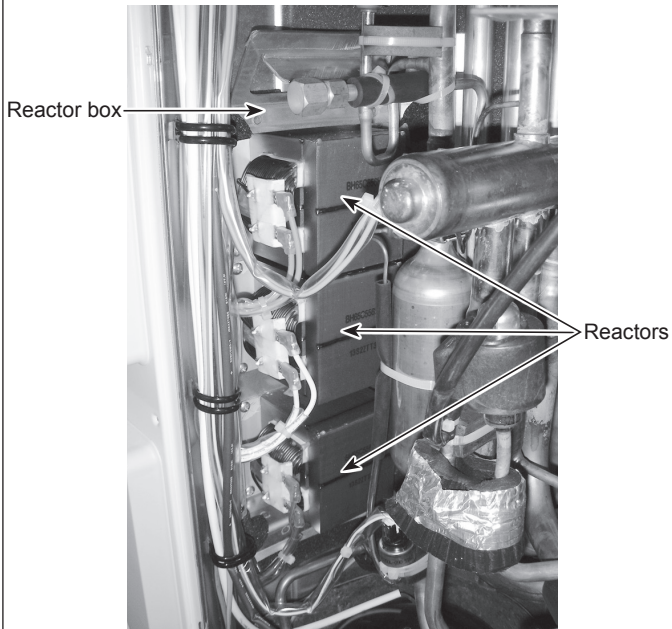
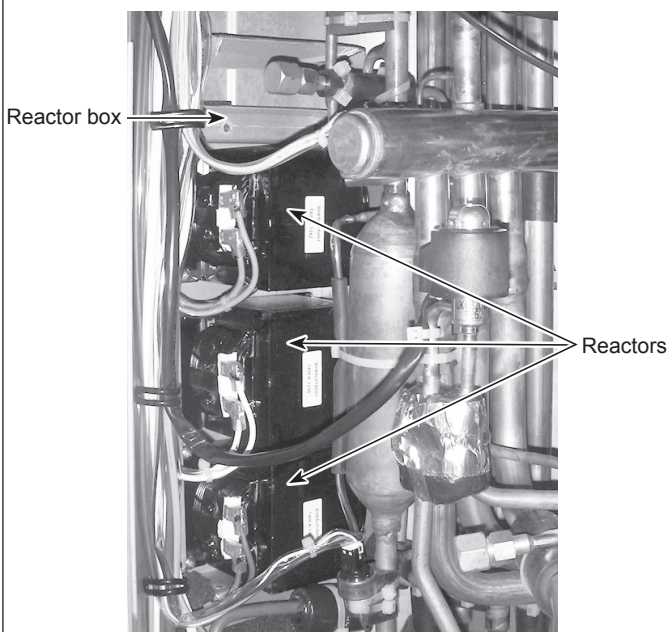

Photo 12-2-2: YHAR2 type



PHOTOS/FIGURES

Photo 12-1

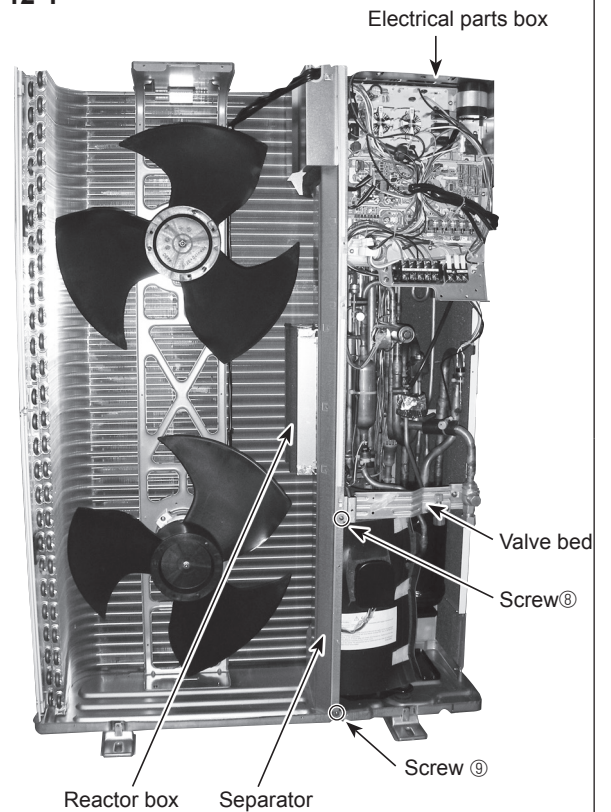
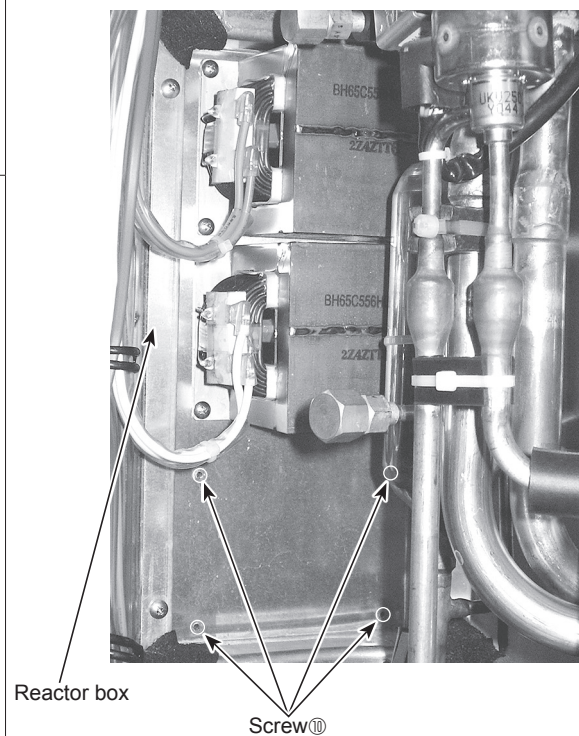

Photo 12-3



OPERATING PROCEDURE

13. Removing the compressor (MC)

- (1) Remove the service panel. (See Photo 1)
- (2) Remove the top panel. (See Photo 1)
- (3) Remove 2 cover panel (front) fixing screws (5 × 12) and remove the cover panel (front). (See Photo 1)
- (4) Remove 2 cover panel (rear) fixing screws (5 × 12) and remove the cover panel (rear).
- (5) Remove the electrical parts box. (See Photo 3)
- (6) Remove the valve bed. (Refer to procedure 9)
- (7) Remove the side panel (R). (Refer to procedure 9)
- (8) Remove 3 separator fixing screws (4 × 10) and remove the separator.
- (9) Remove the soundproof cover for compressor.
- (10) Recover refrigerant.
- (11) Remove the welded pipe of compressor inlet and outlet then remove the compressor.
- (12) Remove the 3 points of the compressor fixing nut using a spanner or a adjustable wrench.

Note: Recover refrigerant without spreading it in the air.

PHOTOS/FIGURES

Photo 13

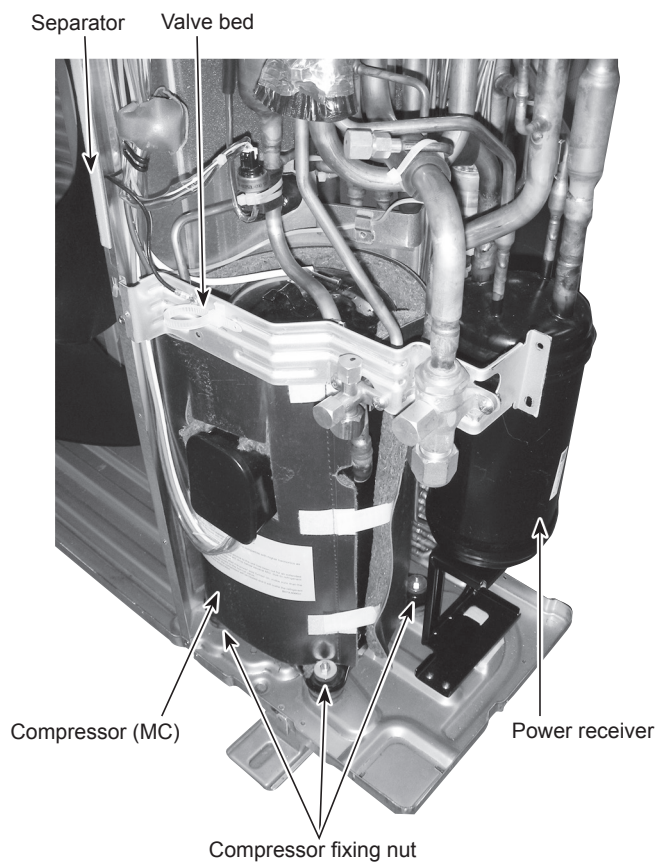

14. Removing the power receiver

- (1) Remove the service panel. (See Photo 1)
- (2) Remove the top panel. (See Photo 1)
- (3) Remove the cover panel (front). (Refer to procedure 13)
- (4) Remove the cover panel (rear). (Refer to procedure 13)
- (5) Remove the electrical parts box. (See Photo 3)
- (6) Remove the valve bed. (Refer to procedure 9)
- (7) Remove the side panel (R). (Refer to procedure 9)
- (8) Recover refrigerant.
- (9) Remove 4 welded pipes of power receiver inlet and outlet.
- (10) Remove 2 receiver leg fixing screws (4 × 10).

Note: Recover refrigerant without spreading it in the air.

Photo 14

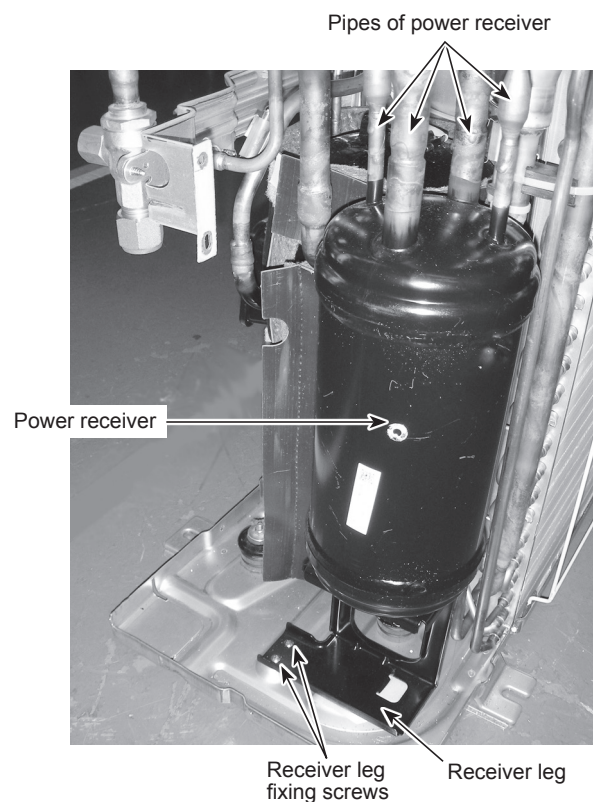

Mr. SLIM

MITSUBISHI ELECTRIC CORPORATION

HEAD OFFICE : TOKYO BUILDING, 2-7-3, MARUNOUCHI, CHIYODA-KU, TOKYO 100-8310, JAPAN

©Copyright 2012 MITSUBISHI ELECTRIC CORPORATION

Issued: Nov. 2017 No.OCH526 REVISED EDITION-E

Issued: Aug. 2015 No.OCH526 REVISED EDITION-D

Issued: Nov. 2014 No.OCH526 REVISED EDITION-C

Issued: Dec. 2013 No.OCH526 REVISED EDITION-B

Issued: Jul. 2013 No.OCH526 REVISED EDITION-A

Published: Sep. 2012 No.OCH526

Made in Japan

Specifications are subject to change without notice.