



Owner's Manual

Original Instructions

Local air conditioner

Model: GPC07AK-K5NNA1A GPC09AK-K5NNA1A
GPC07AK-K5NNA2A GPC09AK-K5NNA2A
GPC07AK-K5NNA3A GPC09AK-K5NNA3A

Thank you for choosing our product.

Please read this Owner's Manual carefully before operation and retain it for future reference.

If you have lost the Owner's Manual, please contact the local agent or visit www.gree.com or send an email to global@gree.com.cn for the electronic version.

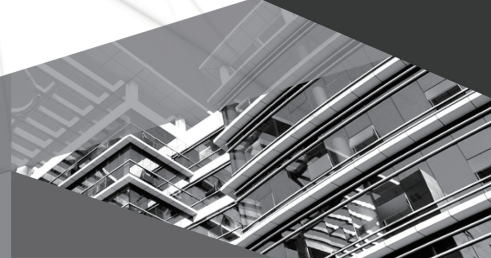

Content

Operation Notices

The Refrigerant	1
Safety Warning	2
Operation Environment	3
Part's Name	4

Operation Guide

Operation Introduction for Control Panel	5
Buttons on Remote Controller	7
Introduction for Icons on Display Screen	7
Introduction for Buttons on Remote Controller	8
Function Introduction for Combination Buttons	12
Operation Guide	13
Replacement of Batteries in Remote Controller	13

Maintenance

Clean and Maintenance	14
-----------------------------	----

Malfunction

Malfunction Analysis	16
----------------------------	----

Installation Notice

Installation Precaution	19
Preparation before Installation	20

Installation

Install Wire Hook	21
Removing Collected Water	22
Installation in a double-hung sash window	25
Installation in a sliding sash window	28
Installation and Disassembly of Heat Discharge Pipe	33

Attached Sheet

Operation Test	36
Electric Schematic Diagram	36
Specialist's Manual	37

This appliance is not intended for use by persons (including children) with reduced physical, sensory or mental capabilities, or lack of experience and knowledge, unless they have been given supervision or instruction concerning use of the appliance by a person responsible for their safety. Children should be supervised to ensure that they do not play with the appliance.



This marking indicates that this product should not be disposed with other household wastes throughout the EU. To prevent possible harm to the environment or human health from uncontrolled waste disposal, recycle it responsibly to promote the sustainable reuse of material resources. To return your used device, please use the return and collection systems or contact the retailer where the product was purchased. They can take this product for environmental safe recycling.

Explanation of Symbols



DANGER

Indicates a hazardous situation that, if not avoided, will result in death or serious injury.



WARNING

Indicates a hazardous situation that, if not avoided, could result in death or serious injury.



CAUTION

Indicates a hazardous situation that, if not avoided, may result in minor or moderate injury.

NOTICE

Indicates important but not hazard-related information, used to indicate risk of property damage.



Indicates a hazard that would be assigned a signal word **WARNING** or **CAUTION**.

Exception Clauses

Manufacturer will bear no responsibilities when personal injury or property loss is caused by the following reasons.

1. Damage the product due to improper use or misuse of the product;
2. Alter, change, maintain or use the product with other equipment without abiding by the instruction manual of manufacturer;
3. After verification, the defect of product is directly caused by corrosive gas;
4. After verification, defects are due to improper operation during transportation of product;
5. Operate, repair, maintain the unit without abiding by instruction manual or related regulations;
6. After verification, the problem or dispute is caused by the quality specification or performance of parts and components that produced by other manufacturers;
7. The damage is caused by natural calamities, bad using environment or force majeure.



Appliance filled with flammable gas R290.



Before install and use the appliance, read the owner's manual first.



Before install the appliance, read the installation manual first.



Before repair the appliance, read the service manual first.

The Refrigerant

- To realize the function of the air conditioner unit, a special refrigerant circulates in the system. The used refrigerant is the fluoride R290, which is specially cleaned. The refrigerant is flammable and inodorous. Furthermore, it can lead to explosion under certain conditions.
- Compared to common refrigerants, R290 is a nonpolluting refrigerant with no harm to the ozone layer. The influence upon the greenhouse effect is also lower. R290 has very good thermodynamic features which lead to a really high energy efficiency. The units therefore need a less filling.
- Please refer to the nameplate for the charging quantity of R290.

WARNING :

- Appliance filled with flammable gas R290.
- Appliance shall be installed, operated and stored in a room with a floor area larger than 11 m².
- The appliance shall be stored in a room without continuously operating ignition sources . (for example: open flames, an operating gas appliance or an operating electric heater.)
- The appliance shall be stored in a well-ventilated area where the room size corresponds to the room area as specified for operation.
- The appliance shall be stored so as to prevent mechanical damage from occurring.
- Ducts connected to an appliance shall not contain an ignition source.
- Keep any required ventilation openings clear of obstruction.
- Do not pierce or burn.
- Be aware that refrigerants may not contain an odour.
- Do not use means to accelerate the defrosting process or to clean, other than those recommended by the manufacturer.
- Servicing shall be performed only as recommended by the manufacturer.
- Should repair be necessary, contact your nearest authorized Service Centre. Any repairs carried out by unqualified personnel may be dangerous.
- Compliance with national gas regulations shall be observed.
- Read specialist's manual.

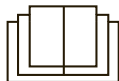

Safety Warning

- This appliance can be used by children aged from 8 years and above and persons with reduced physical, sensory or mental capabilities or lack of experience and knowledge if they have been given supervision or instruction concerning use of the appliance in a safe way and understand the hazards involved. Cleaning and user maintenance shall not be made by children without supervision. Children shall not play with the appliance.
- Before operation, please confirm whether power specification complies with that on nameplate.
- Before cleaning or maintaining the air conditioner, please turn off air conditioner and pull out the power plug.
- Make sure the power cord hasn't been pressed by hard objects.
- Do not pull or drag the power cord to pull out the power plug or move the air conditioner.
- Do not insert or pull out the power plug with wet hands.
- Please use the grounded power. Make sure the grounding is reliable.
- If the supply cord is damaged, it must be replaced by the manufacturer or its service agent or a similarly qualified person in order to avoid a hazard.
- If abnormal condition occurs (e.g. burned smell), please disconnect power at once and then contact local dealer.
- When nobody is taking care of the unit, please turn it off and remove the power plug or disconnect power.
- Do not splash or pour water on air conditioner. Otherwise, it may cause short circuit or damage to air conditioner.
- If drainage hose is used, ambient temperature can't be lower than 0 °C. Otherwise, it will cause water leakage to air conditioner.
- Prohibit operating heating equipment around the air conditioner.
- Prohibit operating the unit in the bathroom or laundry room.
- Far away from fire source, inflammable and explosive objects.
- Children and disabled people are not allowed to use the unit without supervision.
- Keep children from playing or climbing on the air conditioner.
- Do not put or hang dripping objects above the air conditioner.
- Do not repair or disassemble the air conditioner by yourself.
- Prohibit inserting any objects into the air conditioner.

Safety Warning

- Do not use an extension cord.
- Do not through sundries into the air duct. If there are sundries get into the air duct, please contact the professionals to deal with it.

Operation Environment

- The air conditioner must be operated within the temperature range: 16°C ~ 35°C.
- The appliance is for indoor use only.
- The appliance must be positioned so that the plug is accessible.
- This air conditioner can only be used for family, not for commercial industry.
- Reserved space around the air conditioner should be 12"(30cm) at least.
- Do not operate the air conditioner at humid environment.
- Please keep air inlet and air outlet clean, no obstacles.
- During operation, close doors and windows to improve cooling effect.
- Please put the air conditioner at smooth and flat ground for operation to avoid noise and vibration.
- This air conditioner is equipped with castors. Castors should slide at smooth and flat ground.
- Prohibit inclining or turning over the air conditioner. If there's abnormality, please disconnect power immediately and contact dealer.
- Avoid direct sunshine.

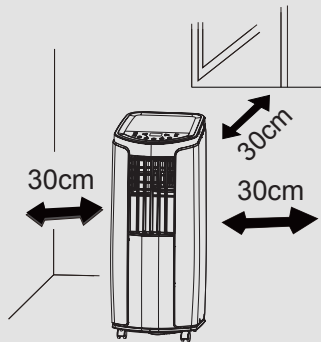

Note:

Graphics in this manual are only for reference. Please refer to actual products for specific details.

Part's Name

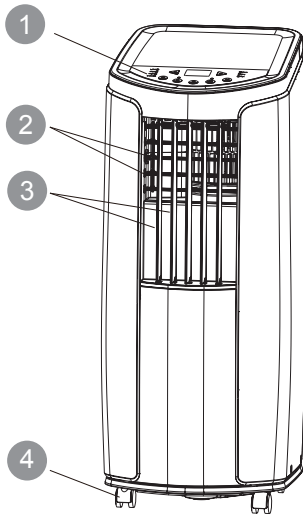

- 1 Controller panel
- 2 Guide louver
- 3 Swing louver
- 4 Castor
- 5 Wire-fixing hook
- 6 Plug of power cord
- 7 Filter
- 8 Air inlet
- 9 Joint A
- 10 Heat discharge pipe
- 11 Joint B+C

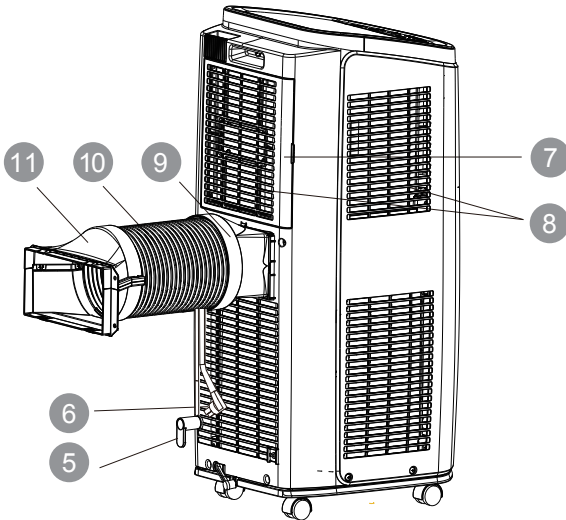

Remote controller

NOTICE:

Heat discharge pipe and other installation accessories can't be discarded.

Operation Introduction for Control Panel

Name of control panel

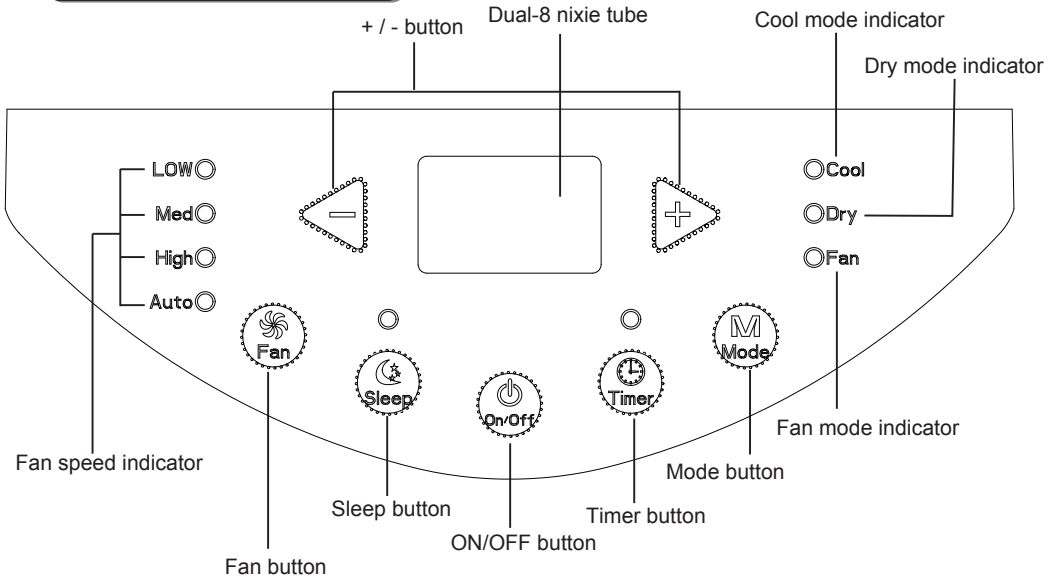

Operation of control panel

Note:

- After putting through the power, the air conditioner will give out a sound. After that, you can operate the air conditioner by the control panel.
- Under ON status, after each pressing of the button on control panel, the air conditioner will give out a sound. Meanwhile, corresponding indicator on control panel will be bright.
- Under OFF status, dual-8 nixie tube on control panel won't display.
Under ON status, dual-8 nixie tube on control panel will display set temperature under cooling mode, while it won't display under other modes.

1 ON/OFF button

Pressing this button can turn on or turn off the air conditioner.

2 + / - button

Under cooling mode, press "+" or "-" button to increase or decrease set temperature by 1°C. Set temperature range is 16°C~30°C. Under auto, drying or fan mode, this button is invalid.

Operation Introduction for Control Panel

3 Mode button

Press this button and the mode will circulate according to below sequence:

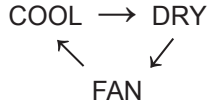

COOL: Under this mode, cooling mode indicator is bright. Dual-8 nixie tube displays set temperature. Temperature setting range is 16°C~30°C.

DRY: Under this mode, drying mode indicator is bright. Dual-8 nixie tube won't display.

FAN: Under this mode, the air conditioner only blow fan. Fan indicator is bright. Dual-8 nixie tube won't display.

4 Fan button

Press this button and the fan speed will circulate as “low speed→ medium speed → high speed→ auto fan→ low speed”.

5 Timer

Press timer button to enter into timer setting mode. Under this mode, press " + " or " - " button to adjust the timer setting. Timer setting will increase or decrease 0.5 hour by pressing " + " or " - " button within 10 hours, while timer setting will increase or decrease 1 hour by pressing " + " or " - " button beyond 10 hours. After timer setting is finished, the unit will display temperature if there's no operation for 5s. If timer function is started up, the upper indicator will keep the display status. Others, it won't be displayed. Under timer mode, press timer button again to cancel timer mode.

6 Sleep

Press sleep button to enter into sleep mode. If the controller operates at cooling mode, after sleep mode is started up, preset temperature will increase by 1°C within 1 hour ;preset temperature will increase by 2°C within 2 hours and then the unit will operate at this temperature all the time; Sleep function is not available for fan mode, drying mode and auto mode. If sleep function is started up, the upper indicator will keep the display status. Others, it won't be displayed.

Buttons on remote controller

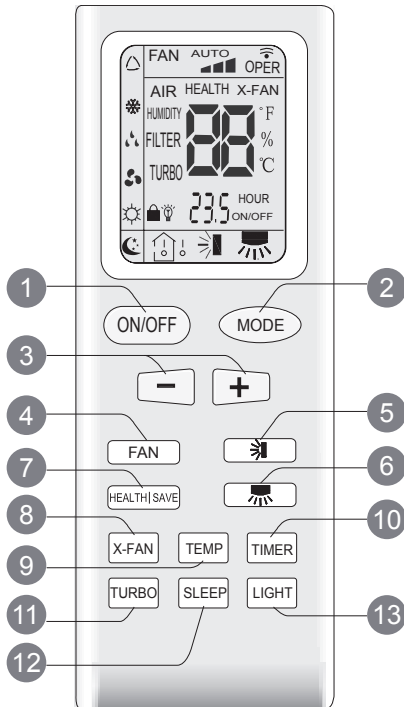

- 1 ON/OFF button
- 2 MODE button
- 3 +/- button
- 4 FAN button
- 5 button
- 6 button
- 7 HEALTH|SAVE button
- 8 X-FAN button
(Note: X-FAN is same with BLOW)
- 9 TEMP button
- 10 TIMER button
- 11 TURBO button
- 12 SLEEP button
- 13 LIGHT button

Introduction for icons on display screen

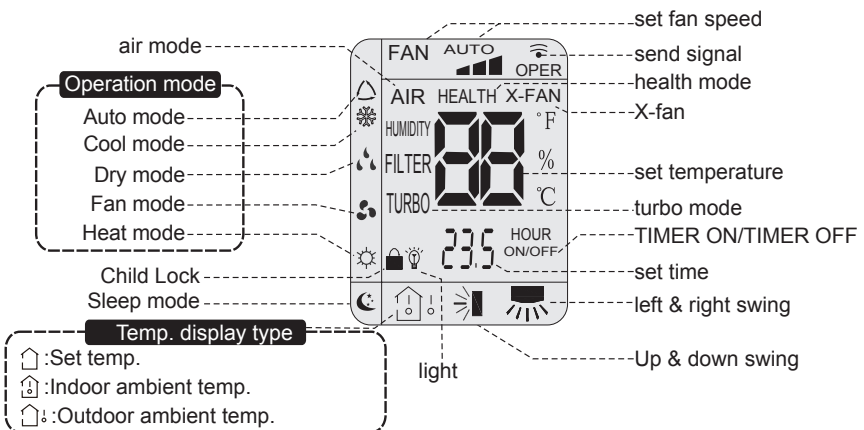

Introduction for buttons on remote controller

Note:

- This is a general use remote controller, it could be used for the air conditioners with multifunction; For some function, which the model doesn't have, if press the corresponding button on the remote controller that the unit will keep the original running status.
- After putting through power, air conditioner will give out a sound and operation indicator "⏻" is ON (red indicator, the colour is different for different models). You can operate the air conditioner through the remote controller.
- At ON status, after each pressing button on remote controller, the signal icon "📶" on remote controller will flash once. Air conditioner will give out a sound, which indicates the signal has been sent to air conditioner.
- At OFF status, display screen on remote controller displays set temperature. At on status, display screen on remote controller displays the corresponding startup function's icon.

1 ON/OFF button

Press this button to turn on the unit. Press this button again to turn off the unit.

2 MODE button

Press this button can select your required operation mode.



- After selecting auto mode, air conditioner will operate automatically according to ambient temperature. Set temperature can't be adjusted and also can't be displayed. Press "FAN" button can adjust fan speed. Press "↗" button can adjust swing angle.
- After selecting cool mode, air conditioner operates under cool mode. Cool indicator "❄️" on indoor unit is ON (This indicator is not available for some models). You can press "+" or "-" button to adjust set temperature. Press "FAN" button can adjust fan speed. Press "↗" button can adjust swing angle.
- After selecting dry mode, air conditioner operates under dry mode at low speed. Dry indicator "💧" on indoor unit is ON (This indicator is not available for some models). Under dry mode, fan speed can't be adjusted. Press "↗" button to adjust swing angle.
- After selecting fan mode, air conditioner operates only under fan mode, All mode indicators on indoor unit is OFF. Operation indicator is ON.(This indicator is not available for some models). Press "FAN" button can adjust fan speed. Press "↗" button to adjust swing angle.
- After selecting heat mode, air conditioner operates under heat mode. Heat indicator "☀️" on indoor unit is ON(This indicator is not available for some models). You can press "+" or "-" button to adjust set temperature. Press "FAN" button to adjust fan speed. Press "↗" button to adjust swing angle. (Cooling only unit can't receive the signal for heating mode.)

Introduction for buttons on remote controller

Note:

For preventing cold wind, after starting up heating mode, indoor fan will blow fan afterdelaying 1-5min. (Details time is decided by indoor ambient temperature)
Temperature setting range on remote controller: 16°C -30°C . Fan speed setting range: auto, low speed, medium speed and high speed.

3 "+" or "-" button

- After each pressing of "+" or "-" button, it can increase or decrease set temperature 1°C . Hold "+" or "-" button, 2s later, set temperature on remote controller will change quickly. After reaching to your required time, loosen the button. Temperature indicator on indoor unit will also change accordingly. (Temperature can't be adjusted under auto mode)
- Under TIMER ON, TIMER OFF or Clock setting, you can press "+" or "-" button to adjust time. (Refer to TIMER button for details)

4 FAN button

Pressing this button can set fan speed circularly as: auto (AUTO), low(▲), medium(▲▲), high(▲▲▲).

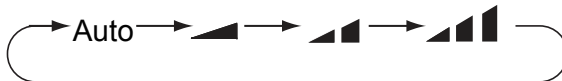

Note:

- Under AUTO Speed, IDU fan motor will adjust the fan speed (high, medium or low speed) according to ambient temperature.
- Fan speed under dry mode is low speed.

5 ㉞ button

- Press this button to start or stop up & down swing function. The remote controller defaults to simple swing condition.
- Press + button and ㉞ button at the same time at unit OFF to switch between simple swing and static swing; ㉞ blinks for 2 seconds.
- In static swing condition, pressing ㉞ button, the swing angle of up & down louver changes as below:

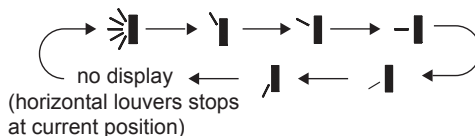

- If the unit is turned off during swing operation, the louver will stop at present position.



Introduction for buttons on remote controller

Note:

When selecting "↔" with remote controller, it's auto swing. Horizontal louver of air conditioner will swing up&down automatically at the maximum angle.

When selecting "┌", "┐", "└", "┘" with remote controller, it's the fixed position swing. Horizontal louver of air conditioner will stop at that position as shown by the icon to swing.

6 button

- Press this button to start or stop left & right swing function. The remote controller defaults to simple swing condition.
- Press + button and  button at the same time at unit OFF to switch between simple swing and static swing;  blinks for 2 seconds.
- In static swing condition, pressing  button, the swing angle of left & right louver changes as below:

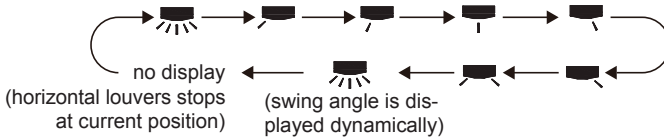

- If the unit is turned off during swing operation, the louver will stop at present position.
- When selecting "↔" with remote controller, it's auto swing. Horizontal louver of air conditioner will swing left&right automatically at the maximum angle.
- When selecting "┌", "┐", "└", "┘" with remote controller, it's the fixed position swing. Horizontal louver of air conditioner will stop at that position as shown by the icon to swing.
- When selecting "⊙" (swing angle is displayed dynamically), it's the circulating swing. Horizontal louver of air conditioner will swing circularly according to the angle as shown by the icon.

Note: There is no this function for some units. If press this key, the main unit will click, but it also runs under original status.

7 HEALTH|SAVE button

HEALTH FUNCTION:

After pressing HEALTH button, remote controller will switch circularly as below: "HEALTH" → "AIR" → "AIR HEALTH" → "no display"

- When selecting "HEALTH" by remote controller, HEALTH function will be started up.
- When selecting "AIR" by remote controller, AIR function will be started up.
- When selecting "AIR HEALTH", AIR and HEALTH function will be started up.
- When there's no display on remote controller, AIR and HEALTH function will be turned off.
- AIR function is applicable for some models.
- HEALTH function is applicable for some models.

Introduction for buttons on remote controller

SAVE function:

Under cool mode, press SAVE button and the unit will operate under SAVE mode. Dual-8nixie tube on remote controller displays "SE". Air conditioner will operate at auto speed. Set temperature can't be adjusted. Press SAVE button again to exit SAVE mode. Air conditioner turn back to original set speed and set temperature.

8 X-FAN button

After pressing this button under cooling or dry mode, remote controller displays the character of "X-FAN" and X-FAN function is started up. Press this button again to cancel X-FAN function. The character of "X-FAN" will disappear.

Note:

- After starting up X-FAN function, when turning off the unit, indoor fan will continue to operate for a while at low speed to dry the residual water inside the indoor unit.
- When the unit operates under X-FAN mode, press "X-FAN" button can turn off X-FAN function. Indoor fan stops operation immediately.

9 TEMP button

Press this button can see indoor set temperature, indoor ambient temperature or outdoor ambient temperature on indoor unit's display. Temperature is set circularly by remote controller as below:

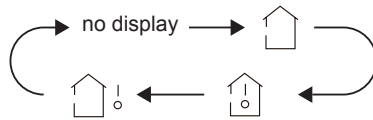

- When selecting "🏠" by remote controller or no display, temperature indicator on indoor unit displays set temperature.
- When selecting "🏠🌡️" by remote controller, temperature indicator on indoor unit displays indoor ambient temperature.
- When selecting "🏠🌡️!" by remote controller, temperature indicator on indoor unit displays outdoor ambient temperature.

Note:

- Outdoor ambient temperature display may can't be selected for some models. When indoor unit receives "🏠🌡️!" signal, it displays indoor set temperature.
- Only for the model whose indoor unit has dual-8 display.

10 TIMER button

- At ON status, press this button once can set TIMER OFF. The character of HOUR and OFF will flash. Press "+" or "-" button within 5s can adjust the time of TIMER OFF. After each pressing of "+" or "-" button, time will increase or decrease half an

Introduction for buttons on remote controller

hour. When holding "+" or "-" button, 2s later, the time will change quickly until to reach to your required time. After that, press "TIMER" button to confirm it. The character of HOUR and OFF won't flash again.

Cancel TIMER OFF: Press "TIMER" button again under TIMER OFF status.

- At OFF status, press this button once can set TIMER ON. Please refer to TIMER off for detailed operation.

Cancel TIMER ON: Press "TIMER" button again under TIMER ON status.

Note:



- Time setting range: 0.5-24 hours.
- Time interval between two operations can't exceed 5s. Otherwise, remote controller will exit the setting status automatically.

11 TURBO button



When pressing this button under cooling or heating mode, air conditioner will enter into quick cooling or quick heating mode. The character of "TURBO" is displayed on remote controller. Press this button again to exit turbo function and the character of "TURBO" will be disappeared on remote controller.

12 SLEEP button

Press this button under cooling, heating mode can start up sleep function.



"" icon will be displayed on remote controller. Press this button again to cancel sleep function. "" icon on remote controller will be displayed.

13 LIGHT button

Press this button can turn off the light for indoor unit's display. "" icon on remote controller will disappear. Press this button again to turn on the light for indoor unit's display. "" icon on remote controller will be displayed.

Function introduction for combination buttons





Child lock function

Press "+" and "-" buttons simultaneously can turn on or turn off child lock function. When child lock function is started up, "" icon will be displayed on remote controller. If operate remote controller, "" icon will flash three times, while remote controller won't send signal.

Switchover function for temperature display

After turning off the unit by remote controller, press "-" button and "MODE" button simultaneously to switch between °C and °F.

Operation guide

1. After putting through the power, press "  " button on remote controller to turn on the air conditioner.
2. Press "  " button to select your required mode: AUTO, COOL, DRY, FAN, HEAT.
3. Press "+" or "-" button to set your required temperature. (Temperature can't be adjusted under auto mode).
4. Press "  " button to set your required fan speed: auto, low, medium and high speed.
5. Press "  " button to select fan blowing angle.

Replacement of batteries in remote controller

1. Press the back side of remote controller marked with "  ", as shown in the fig, and then push out the cover of battery box along the arrow direction.
2. Replace two 7# (AAA 1.5V) dry batteries, and make sure the position of "+" polar and "-" polar are correct.
3. Reinstall the cover of battery box.

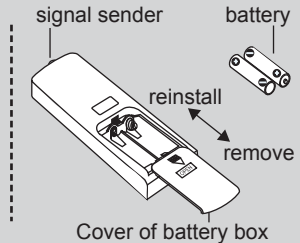

NOTICE

- During operation, point the remote control signal sender at the receiving window on indoor unit.
- The distance between signal sender and receiving window should be no more than 8m, and there should be no obstacles between them.
- Signal may be interfered easily in the room where there is fluorescent lamp or wireless telephone; remote controller should be close to indoor unit during operation.
- Replace new batteries of the same model when replacement is required.
- When you don't use remote controller for a long time, please take out the batteries.
- If the display on remote controller is fuzzy or there's no display, please replace batteries.

Clean and Maintenance



Warning:

- Before cleaning the air conditioner, please turn off the unit and disconnect power. Otherwise, it may cause electric shock.
- Do not wash air conditioner with water. Otherwise, it may cause electric shock.
- Do not use volatile liquid (such as thinner or gas) to clean the air conditioner. Otherwise, it may damage the appearance of air conditioner.

Clean outer case and grille

Clean outer case:

If there's dust on the surface of outer case, please use soft towel to wipe it. If the outer case is very dirty (such as grease), please use neutral abluent to wipe it.

Clean grille: Use cleaner or soft brush to clean it.



Clean filter

1 Remove the filter

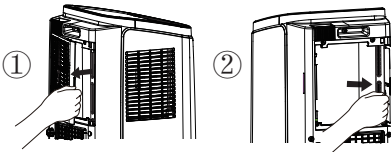

2

Clean filter

Use cleaner or water to clean the filter. If the filter is very dirty (such as grease), use warm water 40°C melted with neutral abluent to clean it and then put at shady place to dry it.

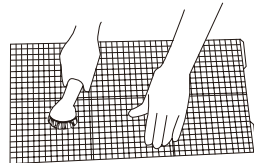

3

Install filter

After the filter is cleaned and dried, reinstall it well.

NOTICE

- The filter should be cleaned about once every three months. If there's much dust in the operation environment, you can increase clean frequency.
- Do not dry the filter with fire or hair drier. Otherwise, it may be deformed or catch fire.

Clean and Maintenance

Clean heat discharge pipe

Remove the heat discharge pipe from air conditioner, clean and dry it , and then reinstall it. (For the method of installation and removal , please refer to the instruction for "Installation and disassembly of heat discharge pipe").

Checking before use-season

1. Check whether air inlets and air outlets are blocked.
2. Check whether plug and socket are in good condition.
3. Check whether filter is clean.
4. Check whether batteries are installed in remote controller.
5. Check whether joint, window bracket and heat discharge pipe are installed tightly.
6. Check whether heat discharge pipe is damaged.

Checking after use-season

1. Disconnect power supply.
2. Clean filter and outer case.
3. Remove dust and sundries on the air conditioner.
4. Eliminate accumulated water in chassis (refer to the section of "Drainage way" for details).
5. Check whether window bracket is damaged or not. If yes, please contact dealer.

Long-time storage

If you don't use the air conditioner for a long time, please maintain it by following steps for good performance:

- Make sure there's no accumulated water in chassis and the heat discharge pipe is disassembled.
- Pull out the plug and wrap the power cord.
- Clean the air conditioner and pack it well to prevent dust.

Notice for recovery

- Many packing materials are recyclable materials. Please deal with them through local recycle bin.
- If you want to throw away the air conditioner, please contact local division or consultant service center for the correct disposal method.

Malfunction Analysis

Please check below items before asking for maintenance. If the malfunction still can't be eliminated, please contact local dealer or qualified professionals.

Phenomenon	Troubleshooting	Solution
Air conditioner can't operate	• Power failure?	• Wait after power recovery.
	• Is plug loose?	• Reinsert the plug.
	• Whether the air switch is tripped off or fuse is burnt?	• Ask professional person to replace air switch or fuse.
	• Is there's malfunction for the circuit?	• Ask professional person to replace circuit.
	• Whether the unit is restarted up after stopping immediately?	• Wait for 3min, and then turn on the unit again.
Poor cooling (heating)	• Is the power too low?	• Wait after voltage is resumed.
	• Whether the air filter is too dirty?	• Clean the air filter.
	• Whether the set temperature is proper?	• Adjust the temperature.
	• Whether door and window are closed?	• Close door and window.
Air conditioner can't receive signal from remote controller or remote controller is not sensible.	• Whether the unit is interfered seriously (such as static pressure, unstable voltage)?	• Please pull out the plug. Insert the plug after about 3min, and then turn on the unit.
	• Whether remote controller is within the receiving range?	• The receiving range of remote controller is 8m. Do not exceed this range.
	• Whether it's blocked by obstacles?	• Remove the obstacles.
	• Is sensitivity of remote controller low?	• Check the batteries of remote controller. If the power is low, please replace the batteries.
	• Whether there's fluorescence lamp in the room?	• Move the remote controller close to air conditioner. • Turn off the fluorescence lamp and try it again.

Malfunction Analysis

Phenomenon	Troubleshooting	Solution
No air blowed out from air conditioner	<ul style="list-style-type: none"> • Whether air outlet or air inlet is blocked? 	<ul style="list-style-type: none"> • Eliminate the obstacles.
	<ul style="list-style-type: none"> • Under heating mode, whether indoor temperature ireaches set temperature? 	<ul style="list-style-type: none"> • The unit will stop blowing fan after reaching set temperature.
	<ul style="list-style-type: none"> • Whether heating mode is started up just now? 	<ul style="list-style-type: none"> • In order to prevent cold air, air conditioner will delay for a while to be started up, which is the normal phenomenon.
	<ul style="list-style-type: none"> • Whether evaporator is defrosted? (observe it by pulling out the filter) 	<ul style="list-style-type: none"> • It's the normal phenomenon. Air conditioner is defrosting. After defrosting is finished, it will resume operation.
Set temperature can't be adjusted.	<ul style="list-style-type: none"> • Whether the unit operates under auto mode? 	<ul style="list-style-type: none"> • Temperature can't be adjusted under auto mode.
	<ul style="list-style-type: none"> • Whether the required temperature exceeds the temperature setting range? 	<ul style="list-style-type: none"> • Temperature setting range: 16°C-30°C .
There's off flavour	<ul style="list-style-type: none"> • There's off-flavour source in the room, such as furniture, cigarette etc. 	<ul style="list-style-type: none"> • Eliminate the off-flavour source. • Clean the filter.
There's abnormal sound during operation	<ul style="list-style-type: none"> • Whether the unit is interfered by thunder, radio, etc? 	<ul style="list-style-type: none"> • Disconnect power, put through the power again, and then turn on the unit again.
You can heard water-flowing sound	<ul style="list-style-type: none"> • Whether the unit is turned on or turned off just now? 	<ul style="list-style-type: none"> • There's flowing sound of refrigerant inside the air conditioner, which is the normal phenomenon.
You can heard the sound of "PAPA"	<ul style="list-style-type: none"> • Whether the unit is turned on or turned off just now? 	<ul style="list-style-type: none"> • Heat expansion or shrinkage for the panel due to change of temperature, which cause friction sound.

Malfunction analysis

Malfunction code

ERROR CODE	Troubleshooting
F0	Please contact qualified professionals for service.
F1	Please contact qualified professionals for service.
F2	Please contact qualified professionals for service.
F4	Please contact qualified professionals for service.
E8	1. Check if the unit is under high-temperature and high-humidity environment; if ambient temperature is too high, power off the unit and then energize it for operation after the ambient temperature drops to 35°C below.
H3	2. Check if the evaporator and condenser are blocked by some objects; if yes, take away the objects, power off the unit and then energize it for operation.
H8	3. If the malfunction still occur, please contact our after-sales service center.
	1. Pour out the water inside chassis.
	2. If "H8" still exists, please contact professional person to maintain the unit.



WARNING

- If there're following phenomenon, please turn off the air conditioner and disconnect the power immediately, and then contact dealer immediately.
 - Power cord is overheating or damaged.
 - Abnormal sound during operation.
 - Off-flavor.
 - Water leakage
- Do not repair or refit the air conditioner by yourself.
- If operate the air conditioner under abnormal condition, it may cause malfunction, electric shock or fire hazard.

Installation Precaution



Warning:

- Observe all governing codes and ordinances.
- Do not use damaged or non-standard power cord.
- Be caution during installation and maintenance. Prohibit incorrect operation to prevent electric shock, casualty and other accidents.

Selection of installation location

Basic requirement

Installing the unit in the following places may cause malfunction. If it is unavoidable, please consult the local dealer:

1. The place with strong heat sources, vapors, flammable or explosive gas, or volatile objects spread in the air.
2. The place with high-frequency devices (such as welding machine, medical equipment).
3. The place near coast area.
4. The place with oil or fumes in the air.
5. The place with sulfureted gas.
6. Other places with special circumstances.

Requirement of air conditioner

1. Air inlet should be far away from obstacles and do not put any objects near air outlet. Otherwise, it will affect the radiation of heat discharge pipe.
2. Select a location where the noise and outflow air emitted by the outdoor unit will not affect neighborhood.
3. Please try your best to keep far away from fluorescent lamp.
4. The appliance shall not be installed in the laundry.

Requirements for electric connection











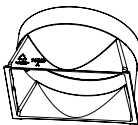

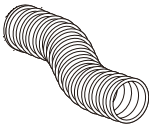
Safety precaution

1. Must follow the electric safety regulations when installing the unit.
2. According to the local safety regulations, use qualified power supply circuit.
3. For appliances with type Y attachment, the instructions shall contain the substance of the following. If the supply cord is damaged, it must be replaced by the manufacturer, its service agent or similarly qualified persons in order to avoid a hazard.
4. Properly connect the live wire, neutral wire and grounding wire of power socket.
5. Be sure to cut off the power supply before proceeding any work related to electricity and safety.
6. Do not put through the power before finishing installation.
7. The air conditioner is first class electric appliance. It must be properly grounding with specialized grounding device by a professional. Please make sure it is always grounded effectively, otherwise it may cause electric shock.
8. The yellow-green wire or green wire in air conditioner is grounding wire, which can't be used for other purposes.
9. The grounding resistance should comply with national electric safety regulations.
10. The appliance shall be installed in accordance with national wiring regulations.

Preparation before Installation











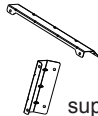

Note: check if the accessories are available before installation.

Accessory list

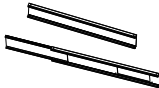



 joint A	 joint B	 joint C	 heat discharge pipe	 Adapter
 wire hook	 screw	 pipe clip	 rubber plug	 pipe hoop
 drainage pipe	 remote controller	 battery (AAA 1.5V)		 user's manual

Optional accessories

Note: some models are without the following accessories.

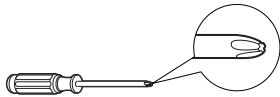
 support	 rain shield	 protective grille	 screw	 nut	 bolt
 window frame	 sponge A	 sponge B	 window fastener	 spring washer	 washer

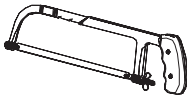
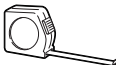
Tools needed for installation

 cross screwdriver	 straight screwdriver	 saw
 gauge	 scissors	 pencil

Install Wire Hook

- Assemble the wire hook at the back of the unit with screws (the direction of wire hook is as shown in following fig).

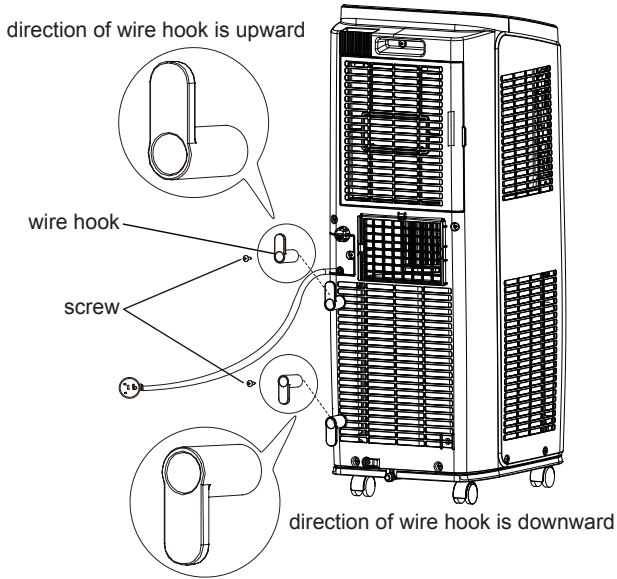

- Wind the power cord around the wire hook.

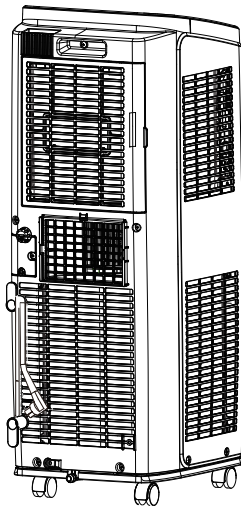

Removing Collected Water

There are 2 ways to remove collected water:

1 Use the continuous drainage option from the bottom hole.

Note: When using the continuous drainage option from the bottom hole, install drainage pipe before using, otherwise poor drainage will affect normal operation of the unit.

■ Instructions for drainage pipe installation as follows.

1. Remove the rubber plug at drainage port.

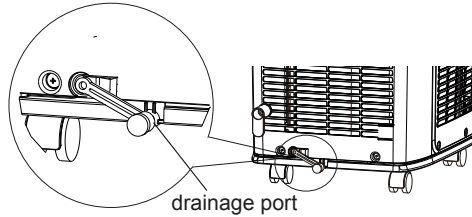

2. Fix the drainage pipe clip on the right of rear side plate near drainage port with a screw.

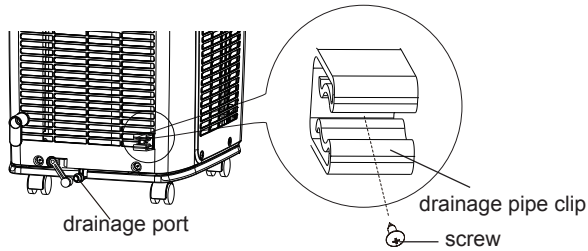

3. Put the drainage pipe into drainage port and screw it up, and then bind it with pipe hoop.

4. Put the rubber plug into the other side of drainage pipe, fix it with pipe hoop and then fix it in the drainage pipe clip.

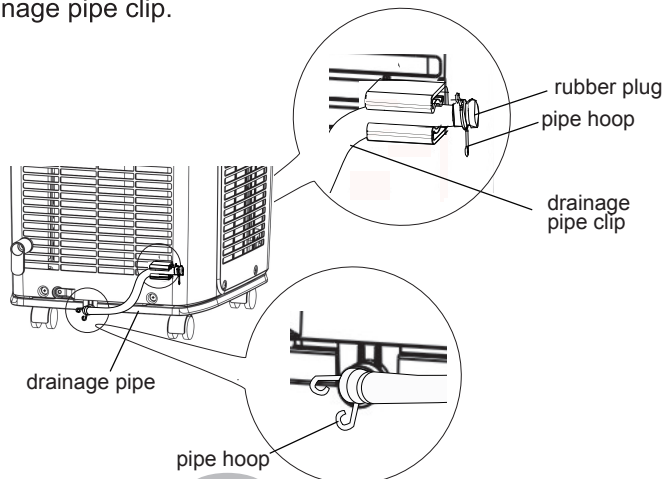

Removing Collected Water

■ Drainage way as follows.

1. In Cool or Dry mode operating, the condensation water will be drained to the chassis.
2. When the chassis is full with water, the buzzer will give out 8 sounds and "H8" is displayed to remind user to discharge water, the unit will turned off about 2min latter, and all buttons are invalid.

To empty the chassis, please follow the instructions bellow.

- Turn the unit off and unplug from the electrical outlet.
- Use a small pan or move the unit to a suitable place to drain the water.
- Take the drainage pipe from the clip and pull out the rubber plug on the drainage pipe to drain the water.
- Drain the water into the small pan or a suitable place.
- Once draining is complete, re-install drain cap.
- Press ON/OFF button to restart the unit.

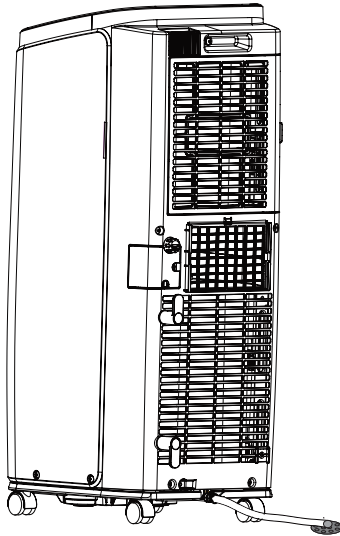

Removing Collected Water

2 Use the continuous drainage option from the middle hole.

Note: Water can be automatically emptied into a floor drain by attaching 14mm inner diameter hose (not included).

1. Remove the continuous drain cap 1 by turning it counter clockwise then remove the rubber stopper 2 from the spout.

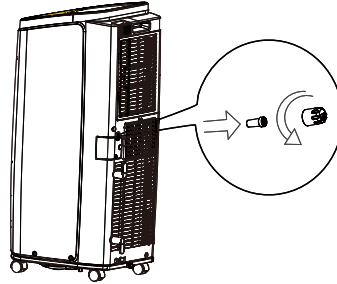

2. Screw the drain connector to (included in the package) the spout by turning clockwise.

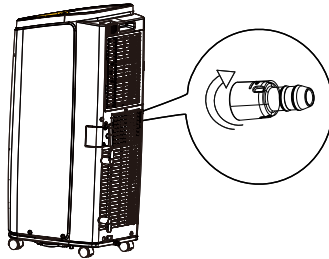

3. Insert the drainage hose into drain connector.

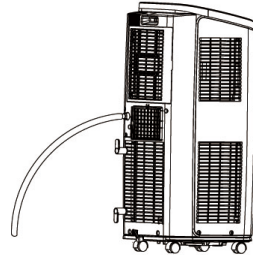

ATTENTION:

When using continuous drainage option from the middle hole, place portable on a level surface and make sure garden hose is clear of any obstructions and is directed downward. Placing portable on an uneven surface or improper hose installation may result in water filling up the chassis and causing the unit to shut off. Empty water in the chassis if shut off occurs, then check portable location and hose for proper setup.

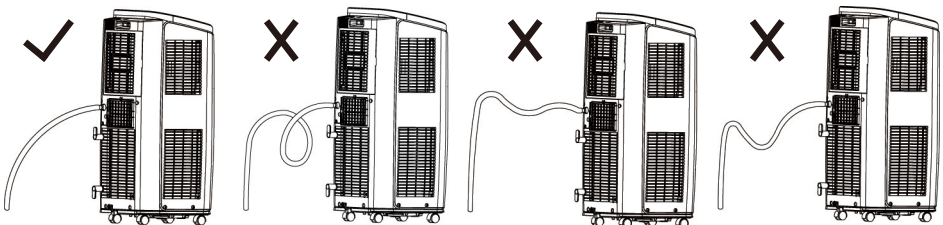

Installation in a double-hung sash window

(Note: If the inner width of window is below 20.5"(520mm), please remove the adjusting panel from window panel and then cut the window panel to make its width the same as the width of window.)

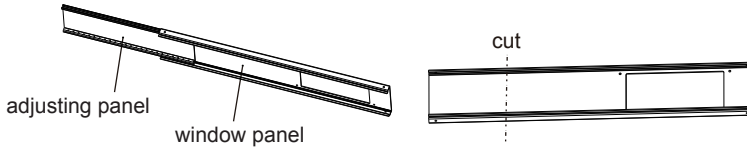

1. Install rear clip — aim the rear clip(upper) at the rear clip(lower),fix them together, press the clasp forcibly in to the groove.

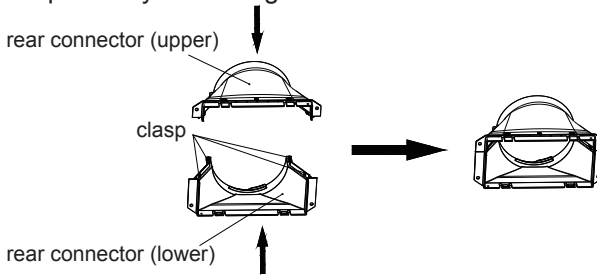

2. Clamp joint B+C into the inner side of window panel along the direction of arrow.

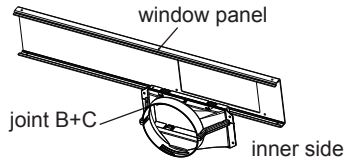

3. Fix the protective grille on joint B+C with screws.

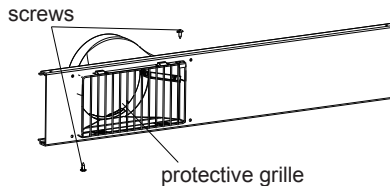

4. Fix the support on the outer side of window panel with nuts, spring washer, washer and bolt.

Installation in a double-hung sash window

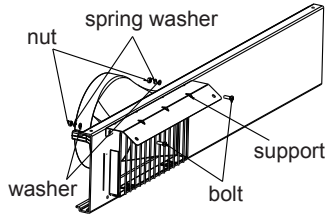

5. Fix the rain shield on the support with nuts, spring washer, washer and bolt.

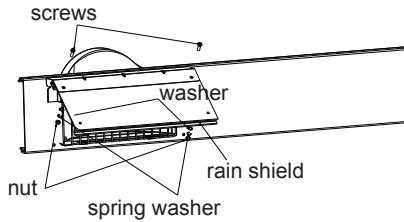

(Note: protective grille, support, rain shield, nut, bolt, spring washer and washer are optional accessories; some models are without these accessories.)

6. Cut the sponge B to a proper length and attach it to the window sash.

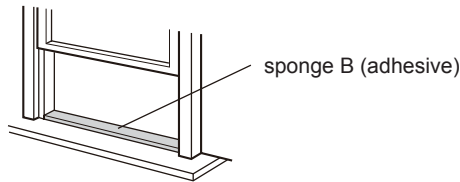

7. Attach the window panel to the window stool.

7.1 If the inner width of the window is less than 20.5"(520mm)

The window panel cannot be installed in windows less than 20.5"(520mm) wide.

- (1) Remove the adjustment panel from the window panel, and cut the window panel to the same width as the window.
- (2) Open the window sash and place the window panel on the window stool.
- (3) Secure the window panel to the window stool with screws.

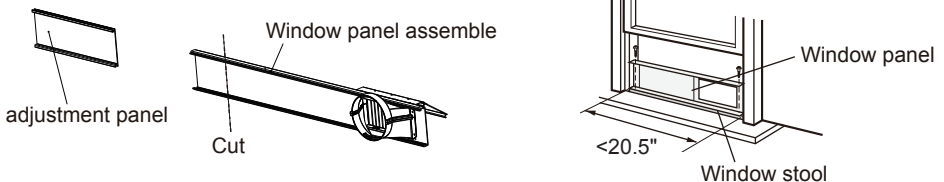

Installation in a double-hung sash window

7.2 If the inner width of the window is between 20.5"(520mm) and 37.4"(950mm) inclusive.

- (1) Open the window sash and place the window panel on the window stool.
- (2) Slide the adjustment panel to fit the window stool width.
- (3) Secure the window panel to the window stool with screws.

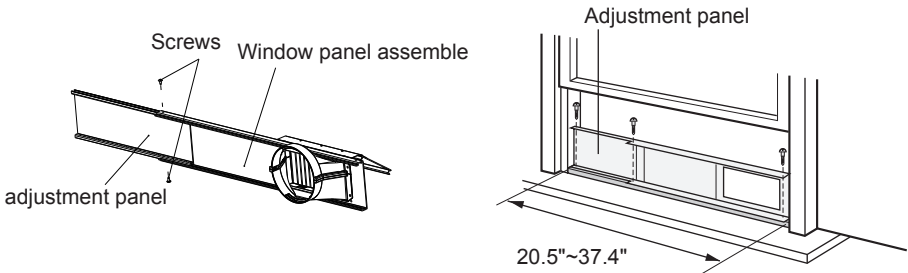

7.3 If the inner width of the window is between 37.4" (950mm) and 56.7" (1440mm) inclusive.

- (1) Attach the extension panel to the adjustment panel.
- (2) Open the window sash and place the window panel on the window stool.
- (3) Slide the adjustment and extension panels to fit the window stool width.
- (4) Secure the window panel to the window stool with screws.

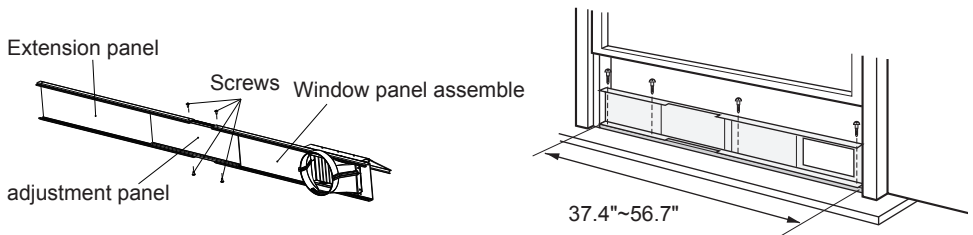

8. Cut the sponge B to a proper length and attach it to the window panel.

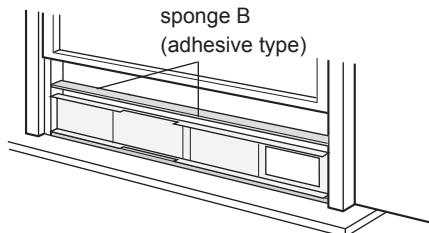

Installation in a double-hung sash window

9. Close the window sash securely against the Window panel.

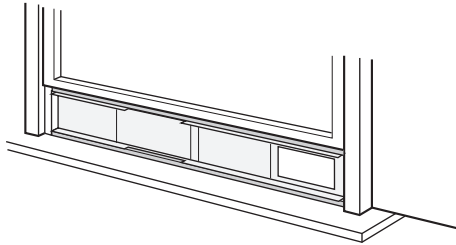

10. Cut the sponge A to a proper length and seal the gap between upper part of inner window sash and outer window sash.

11. Fix the inner window with window bracket and screw, so that it can not slide vertically.

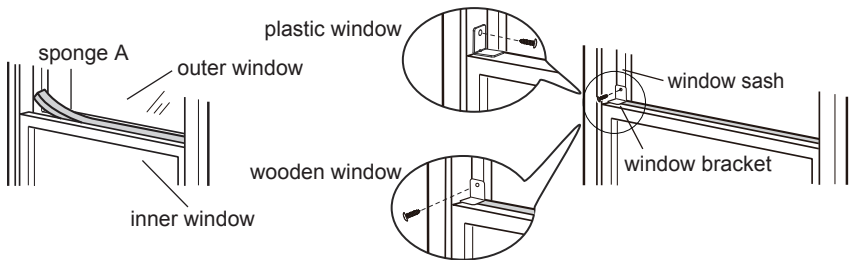

Installation in a sliding sash window

1. Install rear clip — aim the rear clip(upper) at the rear clip(lower),fix them together, press the clasp forcibly in to the groove.

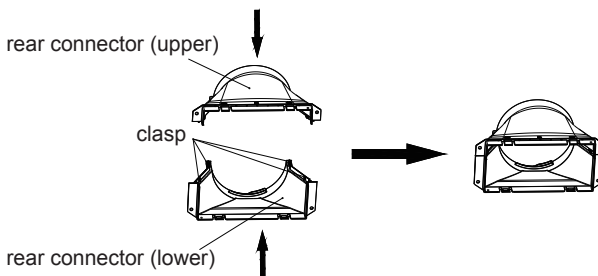

2. Clamp joint B+C into the inner side of window panel along the direction of arrow.

Installation in a sliding sash window

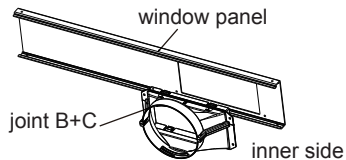

3. Fix the protective grille on joint B+C with screws.

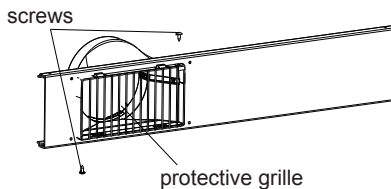

4. Fix the support on the outer side of window panel with nuts, spring washer, washer and bolt.

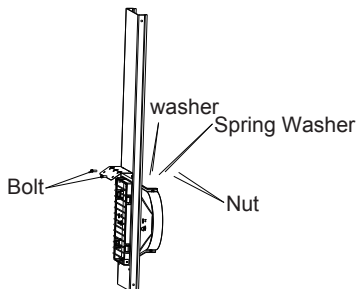

5. Fix the rain shield on the support with nuts, spring washer, washer and bolt.

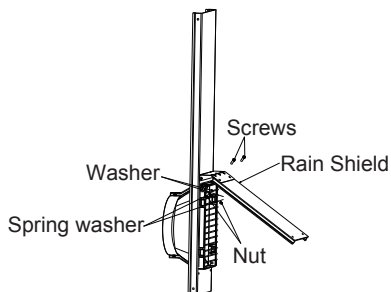

(Note: protective grille, support, rain shield, nut, bolt, spring washer and washer are optional accessories; some models are without these accessories.)

Installation in a sliding sash window

6. Cut the sponge B to a proper length and attach it to the window stool.

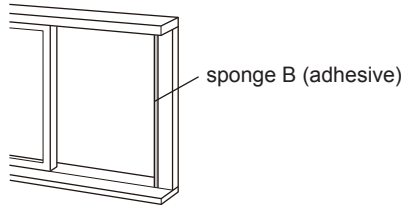

7. Install the window panel into the window stool.

7.1 If the height of the window is less than 20.5"(520mm).

The window panel cannot be installed in windows less than 20.5"(520mm) high.

- (1) Remove the adjustment panel from the window panel, and cut the window panel to the same width as the window.
- (2) Open the window sash and place the window panel on the window stool.
- (3) Secure the window panel to the window stool with screws.

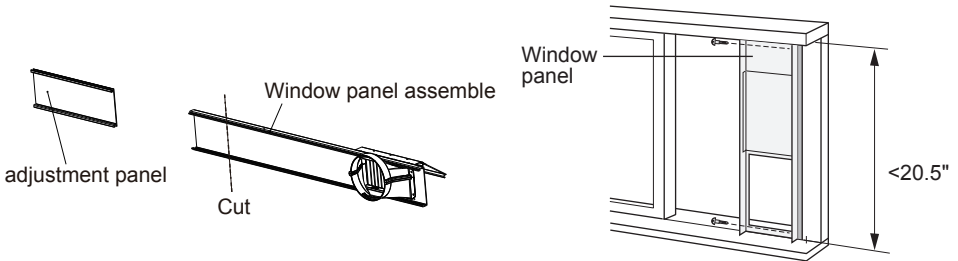

7.2 If the inner width of the window is between 20.5" (520mm) and 37.4"(950mm) inclusive.

- (1) Open the window sash and place the window panel on the window stool.
- (2) Slide the adjustment panel to fit the window stool height.
- (3) Secure the window panel to the window stool with screws.

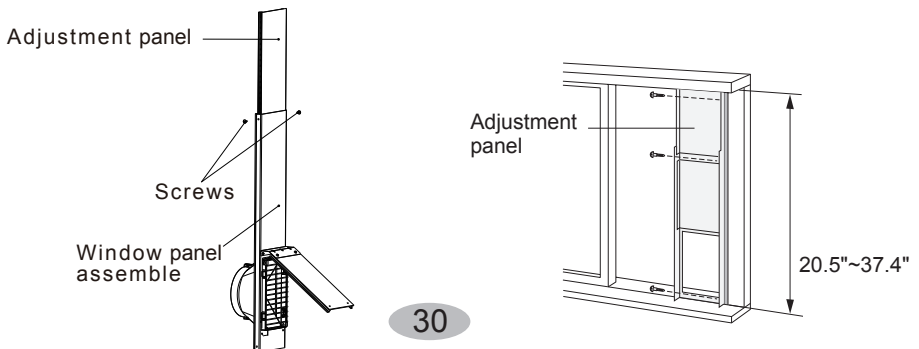

Installation in a sliding sash window

7.3 If the inner width of the window is between 37.4" (950mm) and 56.7" (1440mm) inclusive.

- (1) Attach the extension panel to the adjustment panel.
- (2) Open the window sash and place the window panel on the window stool.
- (3) Slide the adjustment and extension panels to fit the window stool height.
- (4) Secure the window panel to the window stool with screws.

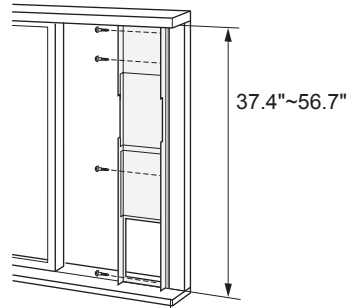
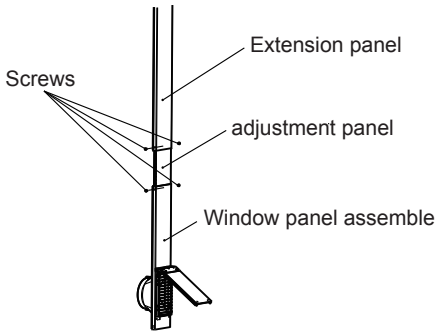

8. Cut the sponge B to a proper length and attach it to the window panel.

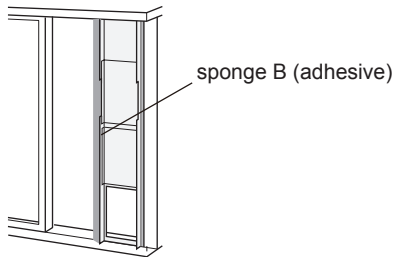

9. Close the window securely against the window panel.

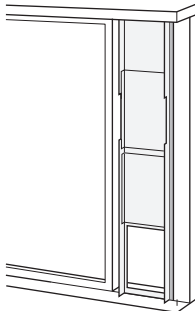

Installation in a sliding sash window

10. Cut the sponge A to a proper length and seal the gap between left side of inner window sash and outer window sash.
11. Fix the inner window with window bracket and screw, so that it can not slide horizontally.

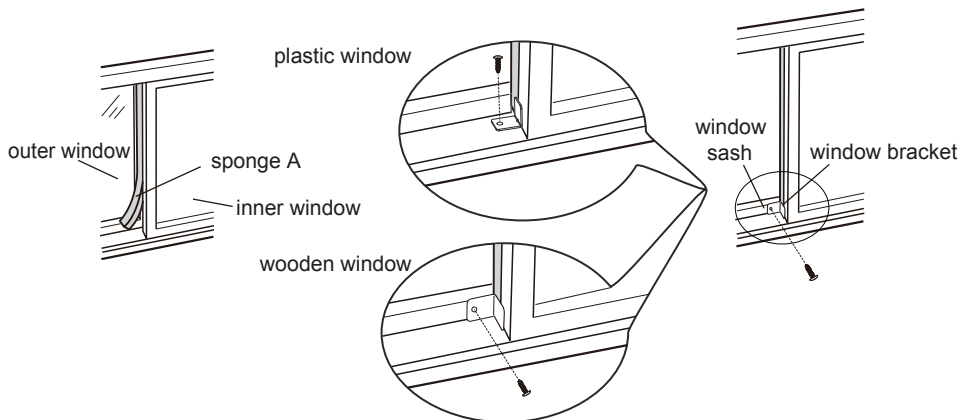

Installation and Disassembly of Heat Discharge Pipe

Install heat discharge pipe

1. Rotate joint A clockwise into the heat discharge pipe.

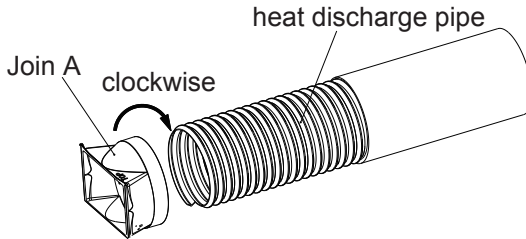

1. Install another side of heat discharge pipe clockwise into protective grille sub-assy.

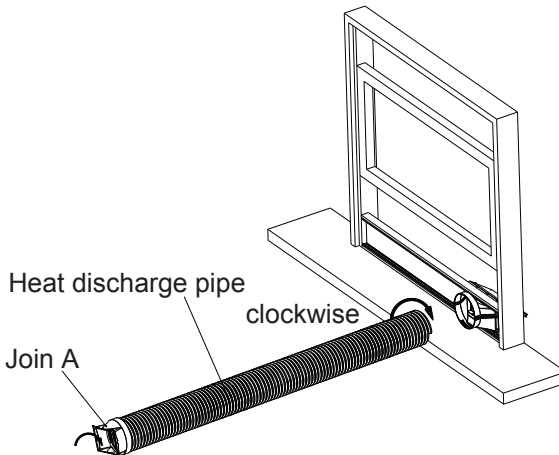

3. Insert joint A of heat discharge pipe (the side with "TOP" is upwards) into the groove until you hear a sound.

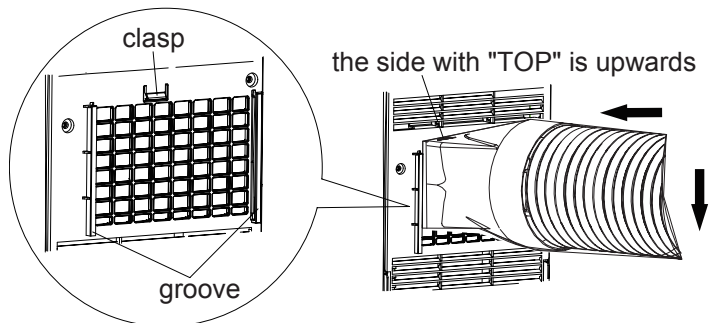

Installation and Disassembly of Heat Discharge Pipe

Note of Installing heat discharge pipe

In order to improve cooling efficiency, the heat discharge pipe should be as short as possible and flat without curve to ensure smooth heat discharge.

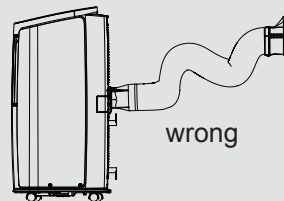
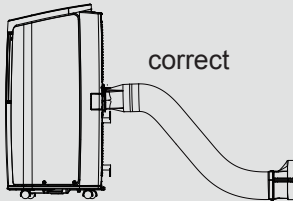
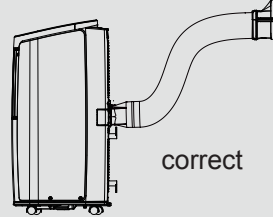
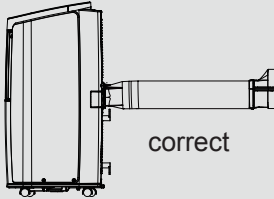

- The length of the heat discharge pipe is less than 1m. It is recommended to use it with shortest length.
- When installing, heat discharge pipe should be as flat as possible. Don't prolong the pipe or connect it with other heat discharge pipe.

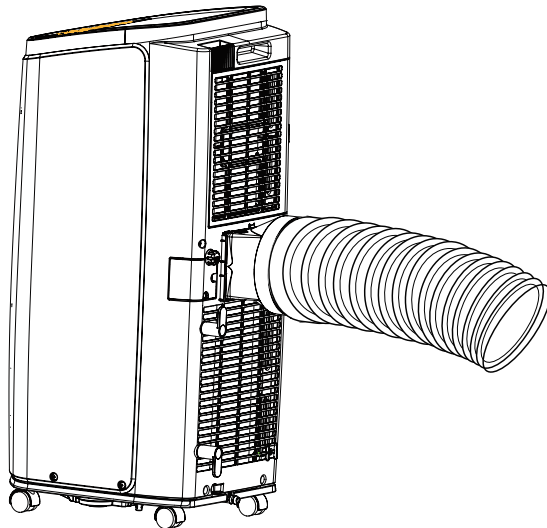

Installation and Disassembly of Heat Discharge Pipe

- Correct installation is as shown in figure (When installing it on wall, height of hall should not be over 130cm from floor).

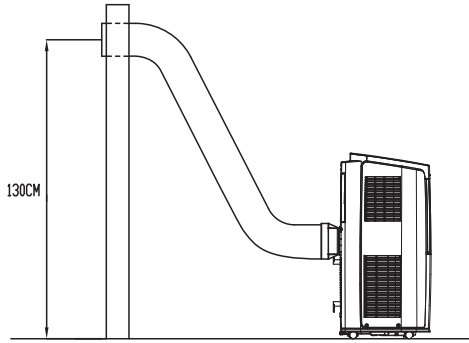

- Wrong installation is shown in following figure (If the pipe is bent too much, it would easily cause malfunction.)

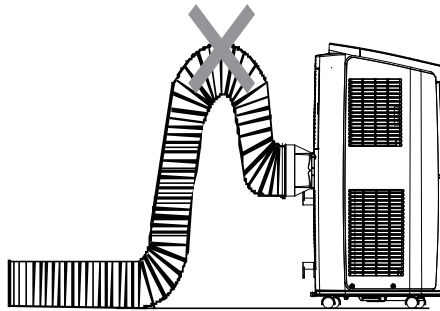

Disassemble heat discharge pipe

1. Remove joint B:
remove joint B from joint C.

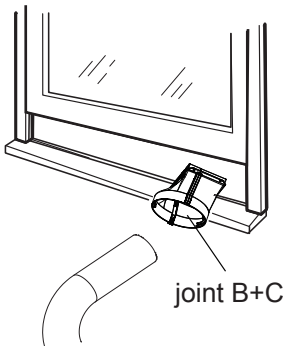

2. Remove joint A:
Press the clasp and lift joint A upwards to remove it.

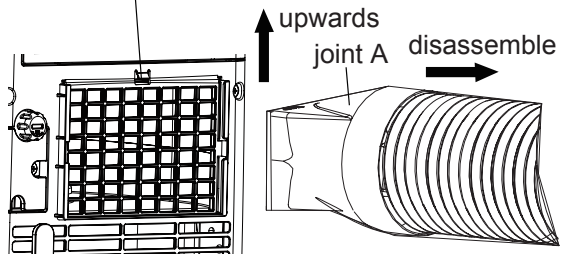

Operation Test

- Put through the power supply and then press ON/OFF button on remote controller to start the unit.
- Press mode button to select auto, cooling, drying, fan or heating function, and then check if the unit operates normally.
- If ambient temperature is below 16°C, the unit can't operate in cooling mode.

Electric Schematic Diagram

The Electric schematic diagram are subject to change without notice. Please refer to which one on the unit.

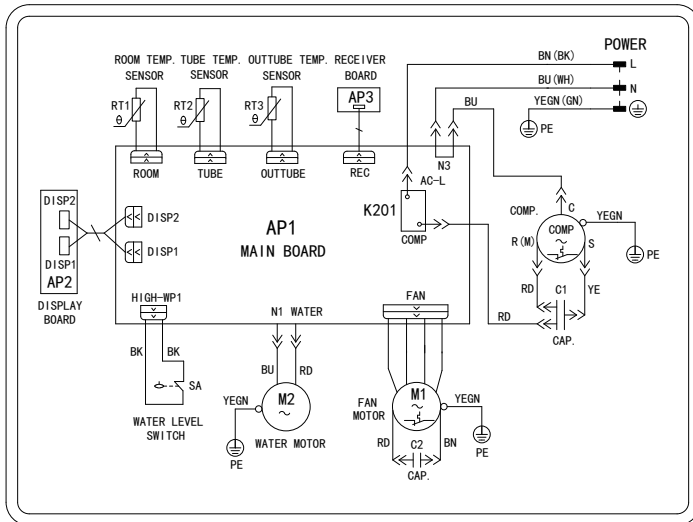

Aptitude requirement for maintenance man(repairs should be done only be specialists).

a. All the work men who are engaging in the refrigeration system should bear the valid certification awarded by the authoritative organization and the qualification for dealing with the refrigeration system recognized by this industry.

b. It can only be repaired by the method suggested by the equipment's manufacturer. If it needs other technician to maintain and repair the appliance, they should be supervised by the person who bears the qualification for using the flammable refrigerant.

Safety preparation work before installation

The safety must be inspected before maintaining the appliances with the flammable refrigerant for reducing the flammable hazard to the lowest.

Work shall be undertaken under a controlled procedure so as to minimise the risk of a flammable gas or vapour being present while the work is being performed.

Detection of flammable refrigerants

Under no circumstances shall potential sources of ignition be used in the searching for or detection of refrigerant leaks. A halide torch (or any other detector using a naked flame) shall not be used.

Environment checking

- All maintenance staff and others working in the local area shall be instructed on the nature of work being carried out. Work in confined spaces shall be avoided. The area around the workspace shall be sectioned off. Ensure that the conditions within the area have been made safe by control of flammable material.
- The area shall be checked with an appropriate refrigerant detector prior to and during work, to ensure the technician is aware of potentially toxic or flammable atmospheres. Ensure that the leak detection equipment being used is suitable for use with all applicable refrigerants, i.e. non-sparking, adequately sealed or intrinsically safe.
- No person carrying out work in relation to a refrigeration system which involves exposing any pipe work shall use any sources of ignition in such a manner that it may lead to the risk of fire or explosion. All possible ignition sources, including cigarette smoking, should be kept sufficiently far away from the site of installation, repairing, removing and disposal, during which refrigerant can possibly be released to the surrounding space. Prior to work taking place, the area around the equipment is to be surveyed to make sure that there are no flammable hazards or ignition risks. "No Smoking" signs shall be displayed.
- If any hot work is to be conducted on the refrigeration equipment or any associated parts, appropriate fire extinguishing equipment shall be available to hand. Have a dry powder or CO₂ fire extinguisher adjacent to the charging area.
- Ensure that the area is in the open or that it is adequately ventilated before breaking into the system or conducting any hot work. A degree of ventilation shall continue during the period that the work is carried out. The ventilation should safely disperse any released refrigerant and preferably expel it externally into the atmosphere.

Specialist's Manual

Refrigeration equipment Checking

Where electrical components are being changed, they shall be fit for the purpose and to the correct specification. At all times the manufacturer's maintenance and service guidelines shall be followed. If in doubt, consult the manufacturer's technical department for assistance.

The following checks shall be applied to installations using flammable refrigerants:

- The actual refrigerant charge is in accordance with the room size within which the refrigerant containing parts are installed;
- The ventilation machinery and outlets are operating adequately and are not obstructed;
- If an indirect refrigerating circuit is being used, the secondary circuit shall be checked for the presence of refrigerant;
- Marking to the equipment continues to be visible and legible. Markings and signs that are illegible shall be corrected;
- Refrigeration pipe or components are installed in a position where they are unlikely to be exposed to any substance which may corrode refrigerant containing components, unless the components are constructed of materials which are inherently resistant to being corroded or are suitably protected against being so corroded.

Electrical devices checking

Repair and maintenance to electrical components shall include initial safety checks and component inspection procedures. If a fault exists that could compromise safety, then no electrical supply shall be connected to the circuit until it is satisfactorily dealt with. If the fault cannot be corrected immediately but it is necessary to continue operation, an adequate temporary solution shall be used. This shall be reported to the owner of the equipment so all parties are advised.

Initial safety checks shall include:

- That capacitors are discharged: this shall be done in a safe manner to avoid possibility of sparking;
- That no live electrical components and wiring are exposed while charging, recovering or purging the system;
- That there is continuity of earth bonding.

Repairs to sealed components

During repairs to sealed components, all electrical supplies shall be disconnected from the equipment being worked upon prior to any removal of sealed covers, etc. If it is absolutely necessary to have an electrical supply to equipment during servicing, then a permanently operating form of leak detection shall be located at the most critical point to warn of a potentially hazardous situation.

Particular attention shall be paid to the following to ensure that by working on electrical components, the casing is not altered in such a way that the level of protection is affected. This shall include damage to cables, excessive number of connections, terminals not made to original specification, damage to seals, incorrect fitting of glands, etc.

Specialist's Manual

- Ensure that the apparatus is mounted securely.
- Ensure that seals or sealing materials have not degraded to the point that they no longer serve the purpose of preventing the ingress of flammable atmospheres. Replacement parts shall be in accordance with the manufacturer's specifications.

NOTE : The use of silicon sealant can inhibit the effectiveness of some types of leak detection equipment. Intrinsically safe components do not have to be isolated prior to working on them.

Cabling

Check that cabling will not be subject to wear, corrosion, excessive pressure, vibration, sharp edges or any other adverse environmental effects. The check shall also take into account the effects of aging or continual vibration from sources such as compressors or fans.

Leak detection methods

The following leak detection methods are deemed acceptable for all refrigerant systems.

Electronic leak detectors may be used to detect refrigerant leaks but, in the case of flammable refrigerants, the sensitivity may not be adequate, or may need re-calibration. (Detection equipment shall be calibrated in a refrigerant-free area.) Ensure that the detector is not a potential source of ignition and is suitable for the refrigerant used. Leak detection equipment shall be set at a percentage of the LFL of the refrigerant and shall be calibrated to the refrigerant employed, and the appropriate percentage of gas (25 % maximum) is confirmed.

Leak detection fluids are suitable for use with most refrigerants but the use of detergents containing chlorine shall be avoided as the chlorine may react with the refrigerant and corrode the copper pipe-work.

If a leak is suspected, all naked flames shall be removed/extinguished.

If a leakage of refrigerant is found which requires brazing, all of the refrigerant shall be recovered from the system, or isolated (by means of shut off valves) in a part of the system remote from the leak. For appliances containing flammable refrigerants, oxygen free nitrogen (OFN) shall then be purged through the system both before and during the brazing process

Removal and evacuation

When breaking into the refrigerant circuit to make repairs – or for any other purpose – conventional procedures shall be used. However, for flammable refrigerants it is important that best practice is followed since flammability is a consideration. The following procedure shall be adhered to:

- remove refrigerant;
- purge the circuit with inert gas;
- evacuate;
- purge again with inert gas;
- open the circuit by cutting or brazing.

Specialist's Manual

The refrigerant charge shall be recovered into the correct recovery cylinders. For appliances containing flammable refrigerants, the system shall be “flushed” with OFN to render the unit safe. This process may need to be repeated several times. Compressed air or oxygen shall not be used for purging refrigerant systems.

For appliances containing flammable refrigerants, flushing shall be achieved by breaking the vacuum in the system with OFN and continuing to fill until the working pressure is achieved, then venting to atmosphere, and finally pulling down to a vacuum. This process shall be repeated until no refrigerant is within the system.

When the final OFN charge is used, the system shall be vented down to atmospheric pressure to enable work to take place. This operation is absolutely vital if brazing operations on the pipe-work are to take place.

Ensure that the outlet for the vacuum pump is not close to any ignition sources and that ventilation is available.

Charging procedures

In addition to conventional charging procedures, the following requirements shall be followed.

- Ensure that contamination of different refrigerants does not occur when using charging equipment. Hoses or lines shall be as short as possible to minimise the amount of refrigerant contained in them.
- Cylinders shall be kept upright.
- Ensure that the refrigeration system is earthed prior to charging the system with refrigerant.
- Label the system when charging is complete (if not already).
- Extreme care shall be taken not to overfill the refrigeration system.

Prior to recharging the system, it shall be pressure-tested with the appropriate purging gas. The system shall be leak-tested on completion of charging but prior to commissioning. A follow up leak test shall be carried out prior to leaving the site.

Decommissioning

Before carrying out this procedure, it is essential that the technician is completely familiar with the equipment and all its detail. It is recommended good practice that all refrigerants are recovered safely. Prior to the task being carried out, an oil and refrigerant sample shall be taken in case analysis is required prior to re-use of reclaimed refrigerant. It is essential that electrical power is available before the task is commenced.

- a) Become familiar with the equipment and its operation.
- b) Isolate system electrically.
- c) Before attempting the procedure, ensure that:
 - mechanical handling equipment is available, if required, for handling refrigerant cylinders;
 - all personal protective equipment is available and being used correctly;
 - the recovery process is supervised at all times by a competent person;
 - recovery equipment and cylinders conform to the appropriate standards.
- d) Pump down refrigerant system, if possible.
- e) If a vacuum is not possible, make a manifold so that refrigerant can be removed from various parts of the system.

Specialist's Manual

- f) Make sure that cylinder is situated on the scales before recovery takes place.
- g) Start the recovery machine and operate in accordance with manufacturer's instructions.
- h) Do not overfill cylinders. (No more than 80 % volume liquid charge).
 - i) Do not exceed the maximum working pressure of the cylinder, even temporarily.
 - j) When the cylinders have been filled correctly and the process completed, make sure that the cylinders and the equipment are removed from site promptly and all isolation valves on the equipment are closed off.
- k) Recovered refrigerant shall not be charged into another refrigeration system unless it has been cleaned and checked.

Labelling

Equipment shall be labelled stating that it has been de-commissioned and emptied of refrigerant. The label shall be dated and signed. For appliances containing flammable refrigerants, ensure that there are labels on the equipment stating the equipment contains flammable refrigerant.

Recovery

When removing refrigerant from a system, either for servicing or decommissioning, it is recommended good practice that all refrigerants are removed safely.

When transferring refrigerant into cylinders, ensure that only appropriate refrigerant recovery cylinders are employed. Ensure that the correct number of cylinders for holding the total system charge are available. All cylinders to be used are designated for the recovered refrigerant and labelled for that refrigerant (i.e. special cylinders for the recovery of refrigerant). Cylinders shall be complete with pressure-relief valve and associated shut-off valves in good working order. Empty recovery cylinders are evacuated and, if possible, cooled before recovery occurs.

The recovery equipment shall be in good working order with a set of instructions concerning the equipment that is at hand and shall be suitable for the recovery of all appropriate refrigerants including, when applicable, flammable refrigerants. In addition, a set of calibrated weighing scales shall be available and in good working order. Hoses shall be complete with leak-free disconnect couplings and in good condition. Before using the recovery machine, check that it is in satisfactory working order, has been properly maintained and that any associated electrical components are sealed to prevent ignition in the event of a refrigerant release. Consult manufacturer if in doubt.

The recovered refrigerant shall be returned to the refrigerant supplier in the correct recovery cylinder, and the relevant waste transfer note arranged. Do not mix refrigerants in recovery units and especially not in cylinders.

If compressors or compressor oils are to be removed, ensure that they have been evacuated to an acceptable level to make certain that flammable refrigerant does not remain within the lubricant. The evacuation process shall be carried out prior to returning the compressor to the suppliers. Only electric heating to the compressor body shall be employed to accelerate this process. When oil is drained from a system, it shall be carried out safely.

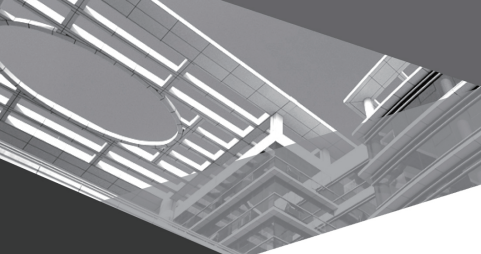

GREE ELECTRIC APPLIANCES, INC. OF ZHUHAI

Add: West Jinji Rd, Qianshan, Zhuhai, Guangdong, China, 519070

Tel: (+86-756) 8522218

Fax: (+86-756) 8669426

E-mail: gree@gree.com.cn www.gree.com

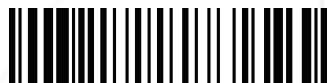

600005061068