



Service Manual

GREE ELECTRIC APPLIANCES, INC. OF ZHUHAI



Table of Contents

Part I : Technical Information	1
1. Summary	1
2. Specifications	3
2.1 Specification Sheet.....	3
2.2 Noise Criteria Curve Tables for Both Models.....	4
3. Outline Dimension Diagram	5
4. Refrigerant System Diagram	6
5. Electrical Part	7
5.1 Wiring Diagram.....	7
5.2 PCB Printed Diagram.....	9
6. Function and Control	10
6.1 Remote Controller Introduction.....	10
6.2 GREE+ App Operation Manual.....	15
6.3 Ewpe Smart App Operation Manual.....	16
6.4 Brief Description of Modes and Functions.....	17
Part II : Installation and Maintenance	20
7. Notes for Installation and Maintenance	20
8. Installation	24
8.1 Installation Dimension Diagram.....	24
8.2 Installation Parts-checking.....	26
8.3 Selection of Installation Location.....	26
8.4 Requirements for electric connection.....	26
8.5 Installation of Indoor Unit.....	26
8.6 Check after Installation and Test.....	29

GWH(07)QB-K6DNC6A/I

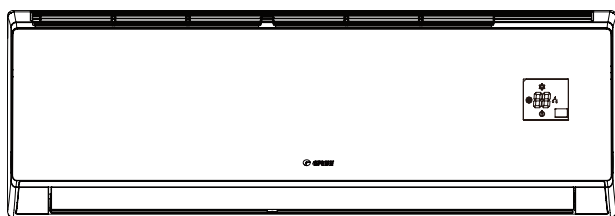

GWH(07)QB-K6DND8A/I

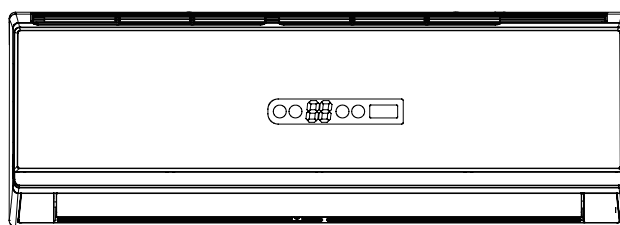

GWH(07)QB-K6DNB4A/I

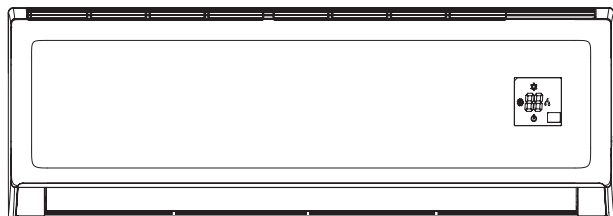

GWH(07)QB-K6DNB8A/I



Remote Controller:

YAN1F6 (WIFI)



Model List:

No	Indoor model	Indoor product code	Remote controller
1	GWH(07)QB-K6DNA1A/I	CB419N12400	YAN1F6 (WIFI)
2	GWH(07)QB-K6DND4A/I	CB464N01300	
3	GWH(07)QB-K6DNE6A/I	CB465N01400	
4	GWH(07)QB-K6DND6A/I	CB460N05500	
5	GWH(07)QB-K6DNC8A/I	CB456N05800	
6	GWH(07)QB-K6DNB6A/I	CB435N09200	
7		CB435N09201	
8	GWH(07)QB-K6DNE4A/I	CB470N02600	
		CB470N02601	
9	GWH(07)QB-K6DNB2A/I	CB432N17500	
10		CB432N17501	
11	GWH(07)QB-K6DNC4A/I	CB444N09700	
12		CB444N09701	
13	GWH(07)QB-K6DNC2A/I	CB439N12500	
14	GWH(07)QB-K6DNA5A/I	CB425N12100	
15	GWH(07)QB-K6DNA2A/I	CB426N06500	
16		CB426N06501	
17	GWH(07)QB-K6DNC6A/I	CB443N05500	
18	GWH(07)QB-K6DNB4A/I	CB434N12800	
19		CB434N12801	
20	GWH(07)QB-K6DND8A/I	CB459N05400	
21		CB459N05401	
22	GWH(07)QB-K6DNB8A/I	CB438N10700	

2. Specifications

2.1 Specification Sheet

Model		1.GWH(07)QB-K6DNA1A/I 2.GWH(07)QB-K6DND4A/I 3.GWH(07)QB-K6DNE6A/I 4.GWH(07)QB-K6DND6A/I 5.GWH(07)QB-K6DNC8A/I 6.GWH(07)QB-K6DNB6A/I 7.GWH(07)QB-K6DNE4A/I 8.GWH(07)QB-K6DNB2A/I 9.GWH(07)QB-K6DNC4A/I 10.GWH(07)QB-K6DNC2A/I 11.GWH(07)QB-K6DNA5A/I 12.GWH(07)QB-K6DNA2A/I 13.GWH(07)QB-K6DNC6A/I 14.GWH(07)QB-K6DNB4A/I 15.GWH(07)QB-K6DND8A/I/I 16.GWH(07)QB-K6DNB8A/I
Product Code		1.CB419N12400 2.CB464N01300 3.CB465N01400 4.CB460N05500 5.CB456N05800 6.CB435N09200/CB435N09201 7.CB470N02600/CB470N02601 8.CB432N17500/CB432N17501 9.CB444N09700/CB444N09701 10.CB439N12500 11.CB425N12100 12.CB426N06500/CB426N06501 13.CB443N05500 14.CB434N12800/CB434N12801 15.CB459N05400/CB459N05401 16.CB438N10700
Rated Voltage	V~	220-240
Rated Frequency	Hz	50
Phases		1
Cooling Capacity	W	2100
Heating Capacity	W	2600
Air Flow Volume (SH/H/M/L)	m ³ /h	560/490/430/330
Dehumidifying Volume	L/h	0.6
Fan Type		Cross-flow
Fan Diameter-height	mm	Φ98X580
Fan Motor Speed (SH/H/M/L) Cool	rpm	1300/1200/1050/800
Fan Motor Speed (SH/H/M/L) Heat	rpm	1300/1200/1050/900
Fan Motor Power Output	W	20
Fan Motor Running Current	A	0.22
Fan Motor Capacitor	μF	1
Evaporator Material		Aluminum Fin-copper Tube
Evaporator Pipe Diameter	mm	Φ5
Evaporator Number of Rows		2
Evaporator Fin Pitch	mm	1.4
Evaporator Length(L)XHeight(H)XWidth(W)	mm	584X22.8X266.7
Motor Model		FN20J-PG
Overload Protector		/
Motor Full Load Amp(FLA)	A	/
Sound Pressure Level (SH/H/M/L)	dB (A)	39/36/32/28
Sound Power Level (SH/H/M/L)	dB (A)	55/52/44/38
Outline Dimension (WXHXD)	mm	790X275X200
Package Carton Dimension (LXWXH)	mm	863X268X352
Package Dimension (LXWXH)	mm	866X271X367
Net Weight	kg	9
Gross Weight	kg	11
Liquid pipe	mm	Φ6
Gas Pipe(to indoor unit)	mm	Φ9.52

Note: The connection pipe applies metric diameter.

The above data is subject to change without notice; please refer to the nameplate of the unit.

2.2 Noise Criteria Curve Tables for Both Models

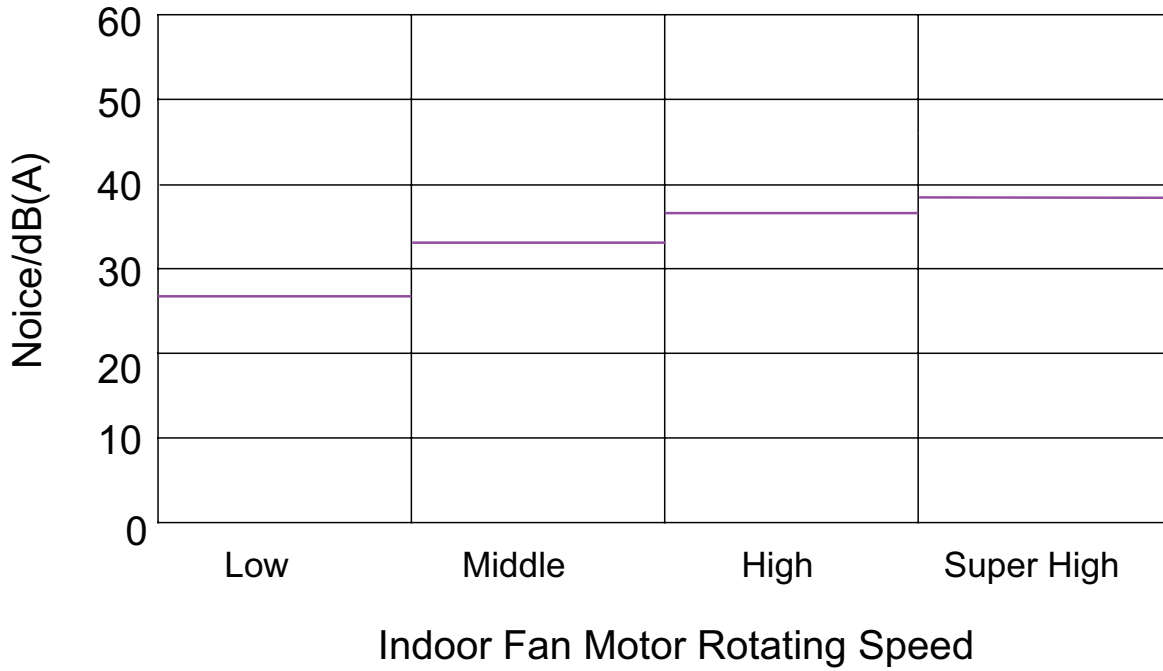

4. Refrigerant System Diagram

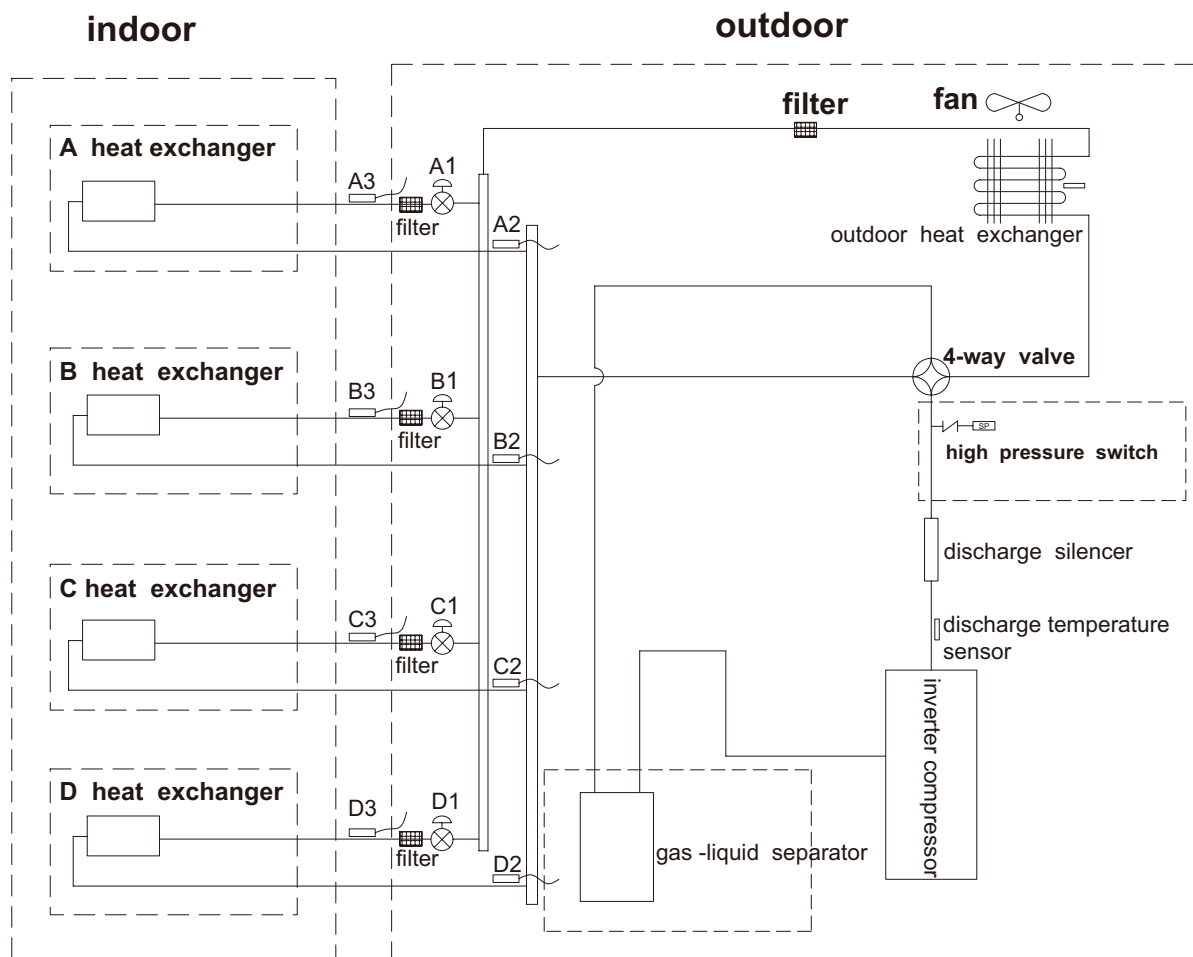

A1:A-unit electronic expansion valve B1:B-unit electronic expansion valve
C1:C-unit electronic expansion valve D1:D-unit electronic expansion valve
A2:A-unit gas pipe temperature sensor B2:B-unit gas pipe temperature sensor
C2:C-unit gas pipe temperature sensor D2:D-unit gas pipe temperature sensor
A3:A-unit liquid pipe temperature sensor B3:B-unit liquid pipe temperature sensor
C3:C-unit liquid pipe temperature sensor D3:D-unit liquid pipe temperature sensor

5.2 PCB Printed Diagram

• Top view

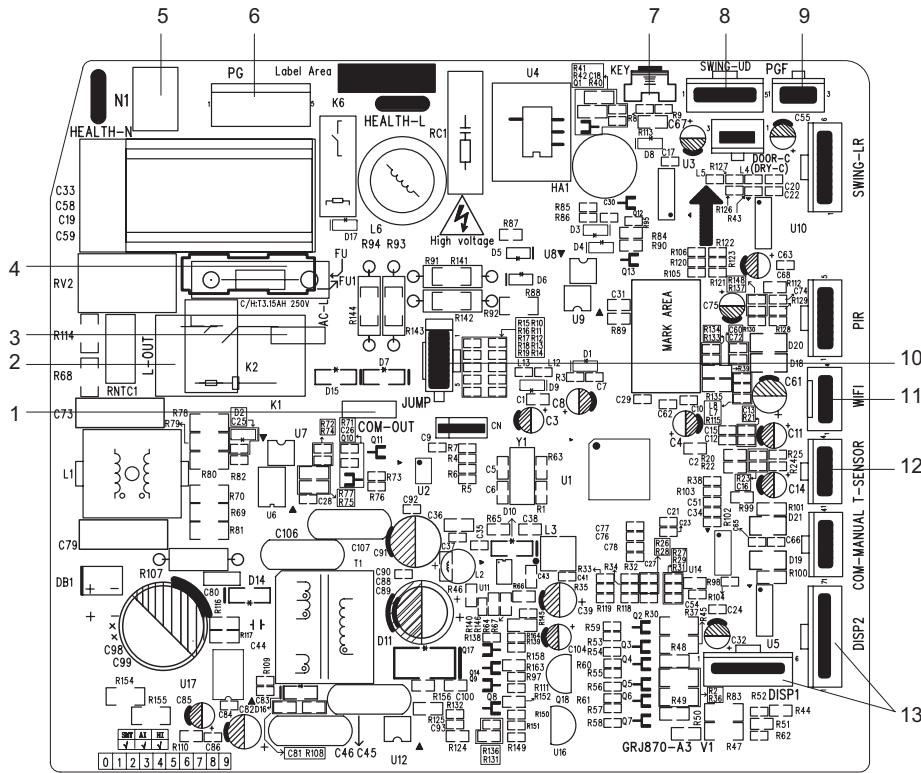

NO.	Name
1	Communication terminal for indoor unit and outdoor unit
2	Terminal of live wire used for supplying power for outdoor unit
3	Terminal of live wire
4	Fuse
5	Neutral wire
6	Interface of PG motor
7	Auto button
8	Interface of up&down swing
9	Feedback interface of PG motor
10	Jumper cap
11	Needle stand for WiFi
12	Interface of temperature sensor
13	Interface of display board

• Bottom view

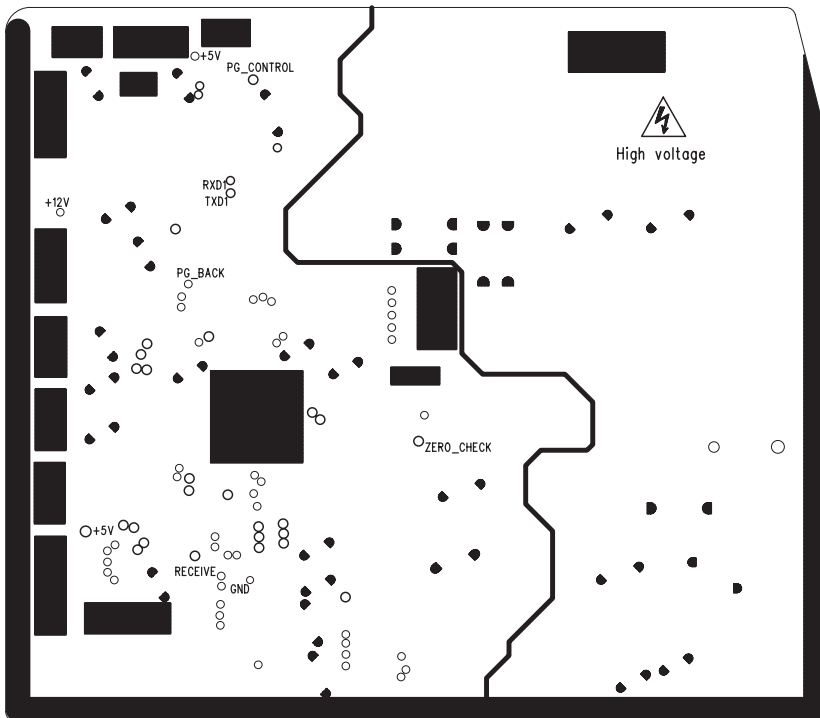

6. Function and Control

6.1 Remote Controller Introduction



- 1 ON/OFF button
- 2 MODE button
- 3 FAN button
- 4 SWING button
- 5 TURBO button
- 6 ▲/ ▼button
- 7 SLEEP button
- 8 TEMP button
- 9 WiFi button
- 10 LIGHT button
- 11 CLOCK button
- 12 TIMER ON / TIMER OFF button

Introduction for icons on display screen

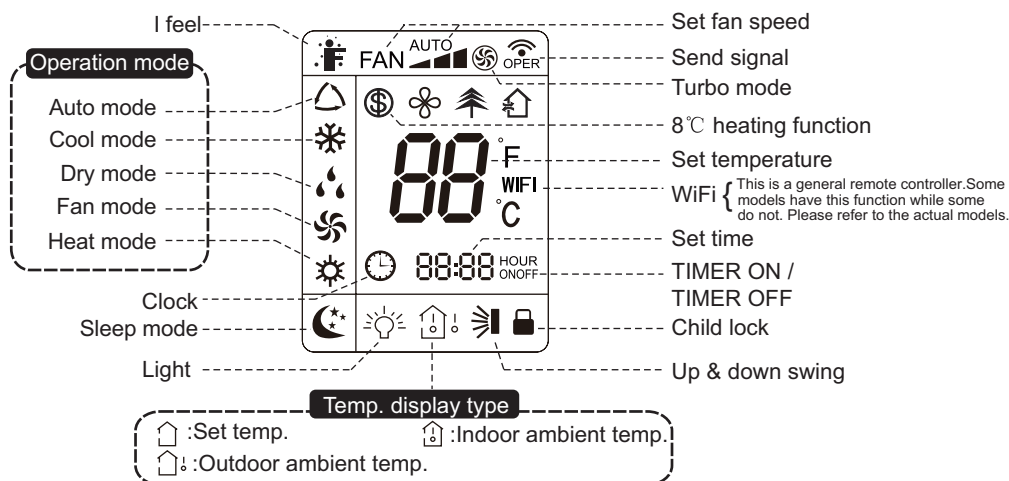

Introduction for buttons on remote controller

Note:

- This is a general use remote controller, it could be used for the air conditioners with multifunction; For some function, which the model doesn't have, if press the corresponding button on the remote controller that the unit will keep the original running status.
- After putting through the power, the air conditioner will give out a sound. Operation indicator is ON (red indicator. the colour is different for different models). After that, you can operate the air conditioner by using remote controller.
- Under on status, pressing the button on the remote controller, the signal icon "📶" on the display of remote controller will blink once and the air conditioner will give out a "de" sound, which means the signal has been sent to the air conditioner.
- Under off status, set temperature and clock icon will be displayed on the display of remote controller (If timer on, timer off and light functions are set, the corresponding icons will be displayed on the display of remote controller at the same time); Under on status, the display will show the corresponding set function icons.

1. ON/OFF button

Press this button to turn on the unit. Press this button again to turn off the unit.

2. MODE button

Press this button to select your required operation mode.

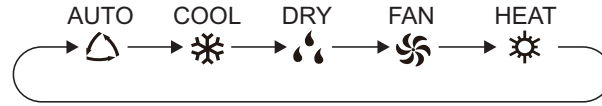

- When selecting auto mode, air conditioner will operate automatically according to ex-factory setting. Set temperature cant be adjusted and will not be displayed as well. Press "FAN" button can adjust fan speed. Press "SWING" button can adjust fan blowing angle.
- After selecting cool mode, air conditioner will operate under cool mode. Cool indicator on indoor unit is ON(This indicator is not available for some models). Press "▲" or "▼" button to adjust set temperature. Press "FAN" button to adjust fan speed. Press "SWING" button to adjust fan blowing angle.
- When selecting dry mode, the air conditioner operates at low speed under dry mode. Dry indicator "💧" on indoor unit is ON(This indicator is not available for some models). Under dry mode, fan speed cant be adjusted. Press "SWING" button to adjust fan blowing angle.
- When selecting fan mode, the air conditioner will only blow fan, no cooling and no heating. All indicators are OFF. Press "FAN" button to adjust fan speed. Press "SWING" button to adjust fan blowing angle.
- When selecting heating mode, the air conditioner operates under heat mode. Heat indicator on indoor unit is ON(This indicator is not available for some models). Press "▲" or "▼" button to adjust set temperature. Press "FAN" button to adjust fan speed. Press "SWING" button to adjust fan blowing angle. (Cooling only unit wont receive heating mode signal. If setting heat mode with remote controller, press ON/OFF button cant start up the unit).

Note:

- For preventing cold air, after starting up heating mode, indoor unit will delay 1~5 minutes to blow air (actual delay time is depend on indoor ambient temperature).
- Set temperature range from remote controller: 16~30°C ; Fan speed: auto, low speed, medium speed, high speed.

3. FAN button

Pressing this button can set fan speed circularly as: auto (AUTO), low(▲), medium(▲▲), high(▲▲▲).

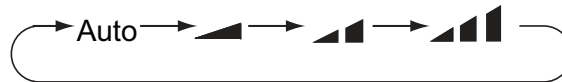

Note:

- Under AUTO speed, air conditioner will select proper fan speed automatically according to ex-factory setting.
- Fan speed under dry mode is low speed.
- X-FAN function: Hold fan speed button for 2s in COOL or DRY mode, the icon "⊗" is displayed and the indoor fan will continue operation for a few minutes in order to dry the indoor unit even though you have turned off the unit. After energization, X-FAN OFF is defaulted. X-FAN is not available in AUTO, FAN or HEAT mode.

This function indicates that moisture on evaporator of indoor unit will be blown after the unit is stopped to avoid mould.

- Having set X-FAN function on: After turning off the unit by pressing ON/OFF button indoor fan will continue running for a few minutes. at low speed. In this period, Hold fan speed button for 2s to stop indoor fan directly.
- Having set X-FAN function off: After turning off the unit by pressing ON/OFF button, the complete unit will be off directly.

4. SWING button

Press this button can select up&down swing angle. Fan blow angle can be selected circularly as below:

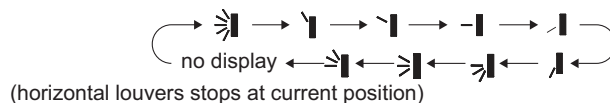

- When selecting "↕", air conditioner is blowing fan automatically. Horizontal louver will automatically swing up & down at maximum angle.
- When selecting "↑", "↓", "←", "→", air conditioner is blowing fan at fixed position. Horizontal louver will stop at the fixed position.
- When selecting "↗", "↘", "↙", "↚", air conditioner is blowing fan at fixed angle. Horizontal louver will send air at the fixed angle.
- Hold "↕" button above 2s to set your required swing angle. When reaching your required angle, release the button.

Note:

- "↗", "↘", "↙", "↚" may not be available. When air conditioner receives this signal, the air conditioner will blow fan automatically.

5. TURBO button

Under COOL or HEAT mode, press this button to turn to quick COOL or quick HEAT mode. "⊗" icon is displayed on remote controller. Press this button again to exit turbo function and "⊗" icon will disappear.

6. ▲/▼ button

- Press "▲" or "▼" button once increase or decrease set temperature 1°C . Holding "▲" or "▼" button, 2s later, set temperature on remote controller will change quickly. On releasing button after setting is finished, temperature indicator on indoor unit will change accordingly. (Temperature cant be adjusted under auto mode)
- When setting TIMER ON, TIMER OFF or CLOCK, press "▲" or "▼" button to adjust time. (Refer to CLOCK, TIMER ON, TIMER OFF buttons)

7. SLEEP button

Under COOL, HEAT mode, press this button to start up sleep function. "☾" icon is displayed on remote controller. Press this button again to cancel sleep function and "☾" icon will disappear.

8. TEMP button

By pressing this button, you can see indoor set temperature, indoor ambient temperature or outdoor ambient temperature on indoor units display. The setting on remote controller is selected circularly as below:

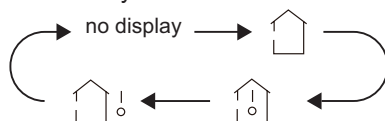

- When selecting "🏠" or no display with remote controller, temperature indicator on indoor unit displays set temperature.
- When selecting "🏠🌡️" with remote controller, temperature indicator on indoor unit displays indoor ambient temperature.
- When selecting "🏠🌡️!" with remote controller, temperature indicator on indoor unit displays outdoor ambient temperature.

Note:

- Outdoor temperature display is not available for some models. At that time, indoor unit receives "🏠🌡️!" signal, while it displays indoor set temperature.
- Its defaulted to display set temperature when turning on the unit. There is no display in the remote controller.
- Only for the models whose indoor unit has dual-8 display.
- When selecting displaying of indoor or outdoor ambient temperature, indoor temperature indicator displays corresponding temperature and automatically turn to display set temperature after three or five seconds.

9. WIFI button

Press "WiFi" button to turn on or turn off WiFi function. When WiFi function is turned on, the "WiFi" icon will be displayed on remote controller; Under status of remote controller off, press "MODE" and "WiFi" buttons simultaneously for 1s, WiFi module will restore to factory default setting.

- This function is only available for some models.

10. LIGHT button

Press this button to turn off display light on indoor unit. "☀️" icon on remote controller disappears. Press this button again to turn on display light. "☀️" icon is displayed.

11. CLOCK button

Press this button to set clock time. "🕒" icon on remote controller will blink. Press "▲" or "▼" button within 5s to set clock time. Each pressing of "▲" or "▼" button, clock time will increase or decrease 1 minute. If hold "▲" or "▼" button, 2s later, time will change quickly. Release this button when reaching your required time. Press "CLOCK" button to confirm the time. "🕒" icon stops blinking.

Note:

- Clock time adopts 24-hour mode.
- The interval between two operation cant exceeds 5s. Otherwise, remote controller will quit setting status. Operation for TIMER ON/TIMER OFF is the same.

12. TIMER ON / TIMER OFF button

● TIMER ON button

"TIMER ON" button can set the time for timer on. After pressing this button, "🕒" icon disappears and the word "ON" on remote controller blinks. Press "▲" or "▼" button to adjust TIMER ON setting. After each pressing "▲" or "▼" button, TIMER ON setting will increase or decrease 1min. Hold "▲" or "▼" button, 2s later, the time will change quickly until reaching your required time. Press "TIMER ON" to confirm it. The word "ON" will stop blinking. "🕒" icon resumes displaying. Cancel TIMER ON: Under the condition that TIMER ON is started up, press "TIMER ON" button to cancel it.

● TIMER OFF button

"TIMER OFF" button can set the time for timer off. After pressing this button, "🕒" icon disappears and the word "OFF" on remote controller blinks. Press "▲" or "▼" button to adjust TIMER OFF setting. After each pressing "▲" or "▼" button, TIMER OFF setting will increase or decrease 1min. Hold "▲" or "▼" button, 2s later, the time will change quickly until reaching your required time. Press "TIMER OFF" word "OFF" will stop blinking. "🕒" icon resumes displaying. Cancel TIMER OFF. Under the condition that TIMER OFF is started up, press "TIMER OFF" button to cancel it.

Note:

- Under on and off status, you can set TIMER OFF or TIMER ON simultaneously.
- Before setting TIMER ON or TIMER OFF, please adjust the clock time.
- After starting up TIMER ON or TIMER OFF, set the constant circulating valid. After that, air conditioner will be turned on or turned off according to setting time. ON/OFF button has no effect on setting. If you don't need this function, please use remote controller to cancel it.

Health function

Health function will be set during operation of indoor fan.

Turn off the unit will also turn off health function.

This function is only available for some models.

Function introduction for combination buttons

1. Energy-saving function

Under cooling mode, press "TEMP" and "CLOCK" buttons simultaneously to start up or turn off energy-saving function. When energy-saving function is started up, "SE" will be shown on remote controller, and air conditioner will adjust the set temperature automatically according to ex-factory setting to reach to the best energy-saving effect. Press "TEMP" and "CLOCK" buttons simultaneously again to exit energy-saving function.

Note:

- Under energy-saving function, fan speed is defaulted at auto speed and it can't be adjusted.
- Under energy-saving function, set temperature can't be adjusted. Press "TURBO" button and the remote controller won't send signal.
- Sleep function and energy-saving function can't operate at the same time. If energy-saving function has been set under cooling mode, press sleep button will cancel energy-saving function. If sleep function has been set under cooling mode, start up the energy-saving function will cancel sleep function.

2. 8 °C heating function

Under heating mode, press "TEMP" and "CLOCK" buttons simultaneously to start up or turn off 8°C heating function. When this function is started up, "8°C" and "8°C" will be shown on remote controller, and the air conditioner keep the heating status at 8°C. Press "TEMP" and "CLOCK" buttons simultaneously again to exit 8°C heating function.

Note:

- Under 8°C heating function, fan speed is defaulted at auto speed and it can't be adjusted.
- Under 8°C heating function, set temperature can't be adjusted. Press "TURBO" button and the remote controller won't send signal.
- Sleep function and 8°C heating function can't operate at the same time. If 8°C heating function has been set under cooling mode, press sleep button will cancel 8°C heating function. If sleep function has been set under cooling mode, start up the 8°C heating function will cancel sleep function.
- Under °F temperature display, the remote controller will display 46 °F heating.

3. Child lock function

Press "▲" and "▼" simultaneously to turn on or turn off child lock function. When child lock function is on, "🔒" icon is displayed on remote controller. If you operate the remote controller, the "🔒" icon will blink three times without sending signal to the unit.

4. Temperature display switchover function

Under OFF status, press "▼" and "MODE" buttons simultaneously to switch temperature display between °C and °F.

5. I FEEL Function

Press "▲" and "MODE" buttons simultaneously to start I FEEL function and "🌡️" will be displayed on the remote controller. After this function is set, the remote controller will send the detected ambient temperature to the controller and the unit will automatically adjust the indoor temperature according to the detected temperature. Press these two buttons simultaneously again to close I FEEL function and "🌡️" will disappear.

- Please put the remote controller near user when this function is set. Do not put the remote controller near the object of high temperature or low temperature in order to avoid detecting inaccurate ambient temperature. When I FEEL function is turned on, the remote controller should be put within the area where indoor unit can receive the signal sent by the remote controller.

If "H1" is displayed on the remote controller while it's not operated by the professional person/after-sales person, it belongs to the misoperation. Please operate it as below to cancel it. Under the OFF status of remote controller, hold the "MODE" button for 5s to cancel "H1" display.

Note:

- If remote controller displays "H1", it belongs to the normal function reminder. If the unit is defrosting under heating mode, it operates according to H1 defrosting mode. "H1" won't be displayed on the panel of indoor unit;
- Once you set H1 mode, if you turn off unit by remote controller, H1 will display 3 times on the remote controller and then disappear;
- Also, when you set H1 mode, when you change to heating mode, H1 will display 3 times on the remote controller and then disappear.

Replacement of batteries in remote controller

1. Press the back side of remote controller marked with "  ", as shown in the fig, and then push out the cover of battery box along the arrow direction.
2. Replace two 7# (AAA 1.5V) dry batteries, and make sure the position of "+" polar and "-" polar are correct.
3. Reinstall the cover of battery box.

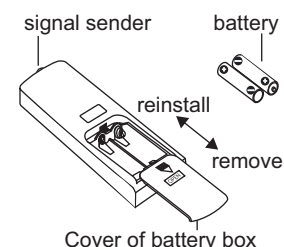

Note:

- During operation, point the remote control signal sender at the receiving window on indoor unit.
- The distance between signal sender and receiving window should be no more than 8m, and there should be no obstacles between them.
- Signal may be interfered easily in the room where there is fluorescent lamp or wireless telephone; remote controller should be close to indoor unit during operation.
- Replace new batteries of the same model when replacement is required.
- When you don't use remote controller for a long time, please take out the batteries.
- If the display on remote controller is fuzzy or there's no display, please replace batteries.

6.3 Ewpe Smart App Operation Manual

Control Flow Chart

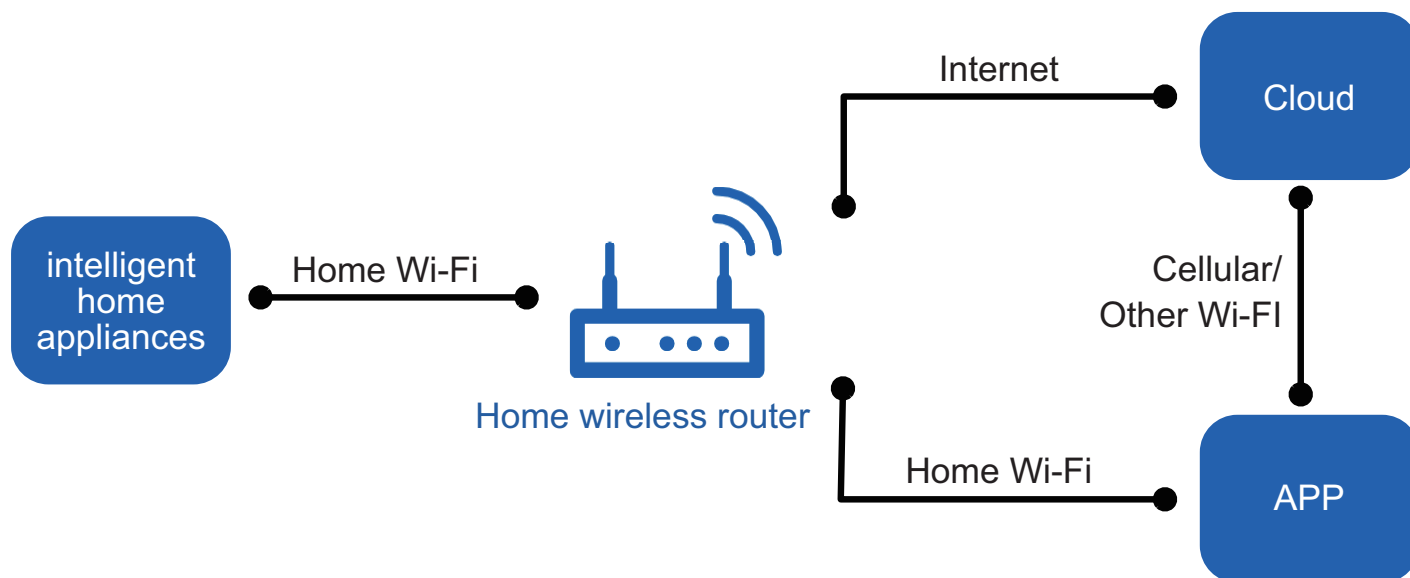

Operating Systems

Requirement for Users smart phone:



iOS system
Support iOS7.0 and
above version



Android system
Support Android 4.4 and
above version

Download and installation



App Download Linkage

Scan the QR code or search "Ewpe Smart" in the application market to download and install it. When "Ewpe Smart" App is installed, register the account and add the device to achieve long-distance control and LAN control of smart home appliances. For more information, please refer to "Help" in App.

6.4 Brief Description of Modes and Functions

1. Basic function of system

(1) Cooling mode

- (1) Under this mode, fan and swing operates at setting status. Temperature setting range is 16~30°C.
- (2) During malfunction of outdoor unit or the unit is stopped because of protection, indoor unit keeps original operation status.

(2) Drying mode

- (1) Under this mode, fan operates at low speed and swing operates at setting status. Temperature setting range is 16~30°C.
- (2) During malfunction of outdoor unit or the unit is stopped because of protection, indoor unit keeps original operation status.
- (3) Protection status is same as that under cooling mode.
- (4) Sleep function is not available for drying mode.

(3) Heating mode

- (1) Under this mode, Temperature setting range is 16~30°C.
- (2) Working condition and process for heating mode:

When turn on the unit under heating mode, indoor unit enters into cold air prevention status. When the unit is stopped or at OFF status, and indoor unit has been started up just now, the unit enters into residual heat-blowing status.

(4) Working method for AUTO mode:

1. Working condition and process for AUTO mode:

a. Under AUTO mode, standard heating $T_{\text{preset}}=20^{\circ}\text{C}$ and standard cooling $T_{\text{preset}}=25^{\circ}\text{C}$. The unit will switch mode automatically according to ambient temperature.

2. Protection function

- a. During cooling operation, protection function is same as that under cooling mode.
- b. During heating operation, protection function is same as that under heating mode.

3. Display: Set temperature is the set value under each condition. Ambient temperature is ($T_{\text{amb.}}-T_{\text{compensation}}$) for heat pump unit and $T_{\text{amb.}}$ for cooling only unit.

4. If there's I feel function, $T_{\text{compensation}}$ is 0. Others are same as above.

(5) Fan mode

Under this mode, indoor fan operates at set fan speed. Compressor, outdoor fan, 4-way valve and electric heating tube stop operation. Indoor fan can select to operate at high, medium, low or auto fan speed. Temperature setting range is 16~30°C.

2. Other control

(1) Buzzer

Upon energization or availably operating the unit or remote controller, the buzzer will give out a beep.

(2) Auto button

If press this auto button when turning off the unit, the complete unit will operate at auto mode. Indoor fan operates at auto fan speed and swing function is turned on. Press this auto button at ON status to turn off the unit.

(3) Auto fan

Heating mode: During auto heating mode or normal heating mode, auto fan speed will adjust the fan speed automatically according to ambient temperature and set temperature.

(4) Sleep

After setting sleep function for a period of time, system will adjust set temperature automatically.

(5) Timer function:

General timer and clock timer functions are compatible by equipping remote controller with different functions.

(6) Memory function

memorize compensation temperature, off-peak energization value.

Memory content: mode, up&down swing, light, set temperature, set fan speed, general timer (clock timer can't be memorized).

After power recovery, the unit will be turned on automatically according to memory content.

(7) Health function

During operation of indoor fan, set health function by remote controller. Turn off the unit will also turn off health function.

Turn on the unit by pressing auto button, and the health is defaulted ON.

(8) I feel control mode

After controller received I feel control signal and ambient temperature sent by remote controller, controller will work according to the ambient temperature sent by remote controller.

(9) Compulsory defrosting function

(1) Start up compulsory defrosting function

Under ON status, set heating mode with remote controller and adjust the temperature to 16°C. Press “+, -, +, -, +,-” button successively within 5s and the complete unit will enter into compulsory defrosting status. Meanwhile, heating indicator on indoor unit will ON 10s and OFF 0.5s successively. (Note: If complete unit has malfunction or stops operation due to protection, compulsory defrosting function can be started up after malfunction or protection is resumed.

(2) Exit compulsory defrosting mode

After compulsory defrosting is started up, the complete unit will exit defrosting operation according to the actual defrosting result, and the complete unit will resume normal heating operation.

(10) Refrigerant recovery function (applicable for moving the unit or maintaining the unit)

(1) Start up refrigerant recovery function

Set cooling mode with remote controller within 5min after energization, adjust temperature at 16°C and press light button on remote controller for 3 times successively to any one indoor unit within 3s and then the complete unit will enter into refrigerant recovery status. All indoor units display Fo. Maintenance person close all liquid valves. After 5min, withstand the thimble of all checking valves with tools one by one. If there's no refrigerant spraying out, close corresponding valve immediately, turn off the unit with remote controller and then remove the connection pipe.

(2) Exit refrigerant recovery function

During refrigerant recovery process, if any one indoor unit receives any remote control signal or refrigerant recovery function has operates for about 25min, refrigerant recovery function will be exited automatically. If the complete unit is at standby status before refrigerant recovery, the complete unit will still at standby status after refrigerant recovery. If the complete unit is at ON status, the unit will operate according to original operation mode.

(11) Ambient temperature display control mode

1. When user set the remote controller to display set temperature (corresponding remote control code: 01), current set temperature will be displayed.

2. Only when remote control signal is switched to indoor ambient temperature display status (corresponding remote control code: 10) from other display status (corresponding remote control code: 00, 01, 11), controller will display indoor ambient temperature for 3s and then turn back to display set temperature.

Under this mode, indoor fan operates at set fan speed. Compressor, outdoor fan, 4-way valve and electric heating tube stop operation. Indoor fan can select to operate at high, medium, low or auto fan speed. Temperature setting range is 16~30°C.

(12) Off-peak energization function

Adjust compressor's minimum stop time. The original minimum stop time is 180s and then we change to:

The time interval between two start-ups of compressor can't be less than $180+T$ s ($0 \leq T \leq 15$). T is the variable of controller. That's to say the minimum stop time of compressor is 180s~195s. Read-in T into memory chip when refurbish the memory chip each time. After power recovery, compressor can only be started up after $180+T$ s at least.

(13) SE control mode

The unit operates at SE status.

(14) X-fan mode

When X-fan function is turned on, after turn off the unit, indoor fan will still operate at low speed for 2min and then the complete unit will be turned off. When x-fan function is turned off, after turn off the unit, the complete unit will be turned off directly.

(15) 8° heating function

Under heating mode, you can set 8° heating function by remote controller. The system will operate at 8° set temperature.

(16) Turbo function

Turbo function can be set under cooling and heating modes. Press Fan Speed button to cancel turbo setting. Turbo function is not available under auto, drying and fan modes.

(17) Mode shock

When there's indoor unit under operation, if start up other indoor unit and the setting mode is inconsistent with that indoor unit, mode shock will occur. The indoor with mode shock displays “E7” and indoor fan stops operation. Corresponding relationship for mode shock and operation status after shock is as below:

Mode relationship table for mode shock:

Mode		Indoor unit with mode shock	Operation status after mode shock	
Indoor unit A	Indoor unit B		Indoor unit A	Indoor unit B
Cooling/drying	heating	Indoor unit B	Cooling/drying	Indoor fan stops operation
Heating	Cooling, drying, fan	Indoor unit B	Heating	Indoor fan stops operation
Fan	Heating	Indoor unit A	Indoor fan stops operation	Heating

Note: (1) Indoor unit A: The indoor unit under operation currently

(2) Indoor unit B: The indoor unit is tuned on latter

(3) If set auto mode with remote controller, the complete unit will judge according to actual operation mode under auto mode.

Part II : Installation and Maintenance

7. Notes for Installation and Maintenance

Safety Precautions: Important!

Please read the safety precautions carefully before installation and maintenance.

The following contents are very important for installation and maintenance.

Please follow the instructions below.

- The installation or maintenance must accord with the instructions.
- Comply with all national electrical codes and local electrical codes.
- Pay attention to the warnings and cautions in this manual.
- All installation and maintenance shall be performed by distributor or qualified person.
- All electric work must be performed by a licensed technician according to local regulations and the instructions given in this manual.
- Be caution during installation and maintenance. Prohibit incorrect operation to prevent electric shock, casualty and other accidents.



Warnings

Electrical Safety Precautions:

1. Cut off the power supply of air conditioner before checking and maintenance.
2. The air condition must apply specialized circuit and prohibit share the same circuit with other appliances.
3. The air conditioner should be installed in suitable location and ensure the power plug is touchable.
4. Make sure each wiring terminal is connected firmly during installation and maintenance.
5. Have the unit adequately grounded. The grounding wire can't be used for other purposes.
6. Must apply protective accessories such as protective boards, cable-cross loop and wire clip.
7. The live wire, neutral wire and grounding wire of power supply must be corresponding to the live wire, neutral wire and grounding wire of the air conditioner.
8. The power cord and power connection wires can't be pressed by hard objects.
9. If power cord or connection wire is broken, it must be replaced by a qualified person.
10. If the power cord or connection wire is not long

enough, please get the specialized power cord or connection wire from the manufacture or distributor. Prohibit prolong the wire by yourself.

11. For the air conditioner without plug, an air switch must be installed in the circuit. The air switch should be all-pole parting and the contact parting distance should be more than 3mm.

12. Make sure all wires and pipes are connected properly and the valves are opened before energizing.

13. Check if there is electric leakage on the unit body. If yes, please eliminate the electric leakage.

14. Replace the fuse with a new one of the same specification if it is burnt down; don't replace it with a cooper wire or conducting wire.

15. If the unit is to be installed in a humid place, the circuit breaker must be installed.

Installation Safety Precautions:

1. Select the installation location according to the requirement of this manual.(See the requirements in installation part)
2. Handle unit transportation with care; the unit should not be carried by only one person if it is more than 20kg.
3. When installing the indoor unit and outdoor unit, a sufficient fixing bolt must be installed; make sure the installation support is firm.
4. Ware safety belt if the height of working is above 2m.
5. Use equipped components or appointed components during installation.
6. Make sure no foreign objects are left in the unit after finishing installation.

Refrigerant Safety Precautions:

When refrigerant leaks or requires discharge during installation, maintenance, or disassembly, it should be handled by certified professionals or otherwise in compliance with local laws and regulations.

1. Avoid contact between refrigerant and fire as it generates poisonous gas; Prohibit prolong the connection pipe by welding.

2. Apply specified refrigerant only. Never have it mixed with any other refrigerant. Never have air remain in the refrigerant line as it may lead to rupture or other hazards.

3. Make sure no refrigerant gas is leaking out when installation is completed.

4. If there is refrigerant leakage, please take sufficient measure to minimize the density of refrigerant.

5. Never touch the refrigerant piping or compressor without wearing glove to avoid scald or frostbite.

Improper installation may lead to fire hazard, explosion, electric shock or injury.

Safety Precautions for Installing and Relocating the Unit:

To ensure safety, please be mindful of the following precautions.



Warnings

1. When installing or relocating the unit, be sure to keep the refrigerant circuit free from air or substances other than the specified refrigerant.

Any presence of air or other foreign substance in the refrigerant circuit will cause system pressure rise or compressor rupture, resulting in injury.

2. When installing or moving this unit, do not charge the refrigerant which is not comply with that on the nameplate or unqualified refrigerant.

Otherwise, it may cause abnormal operation, wrong action, mechanical malfunction or even series safety accident.

3. When refrigerant needs to be recovered during relocating or repairing the unit, be sure that the unit is running in cooling mode. Then, fully close the valve at high pressure side (liquid valve). About 30-40 seconds later, fully close the valve at low pressure side (gas valve), immediately stop the unit and disconnect power. Please note that the time for refrigerant recovery should not exceed 1 minute.

If refrigerant recovery takes too much time, air may be sucked in and cause pressure rise or compressor rupture, resulting in injury.

4. During refrigerant recovery, make sure that liquid valve and gas valve are fully closed and power is disconnected before detaching the connection pipe.

If compressor starts running when stop valve is open and connection pipe is not yet connected, air will be sucked in and cause pressure rise or compressor rupture, resulting in injury.

5. When installing the unit, make sure that connection pipe is securely connected before the compressor starts running.

If compressor starts running when stop valve is open and connection pipe is not yet connected, air will be sucked in and cause pressure rise or compressor rupture, resulting in injury.

6. Prohibit installing the unit at the place where there may be leaked corrosive gas or flammable gas.

If there leaked gas around the unit, it may cause explosion and other accidents.

7. Do not use extension cords for electrical connections. If the electric wire is not long enough, please contact a local service center authorized and ask for a proper electric wire.

Poor connections may lead to electric shock or fire.

8. Use the specified types of wires for electrical connections between the indoor and outdoor units. Firmly clamp the wires so that their terminals receive no external stresses.

Electric wires with insufficient capacity, wrong wire connections and insecure wire terminals may cause electric shock or fire.

Safety Precautions for Refrigerant

● To realize the function of the air conditioner unit, a special refrigerant circulates in the system. The used refrigerant is the fluoride R32, which is specially cleaned. The refrigerant is flammable and odorless. Furthermore, it can lead to explosion under certain conditions. But the flammability of the refrigerant is very low. It can be ignited only by fire.

● Compared to common refrigerants, R32 is a nonpolluting refrigerant with no harm to the ozone layer. The influence upon the greenhouse effect is also lower. R32 has got very good thermodynamic features which lead to a really high energy efficiency.

The units therefore need a less filling.

WARNING:

● Do not use means to accelerate the defrosting process or to clean, other than those recommended by the manufacturer. Should repair be necessary, contact your nearest authorized Service Centre. Any repairs carried out by unqualified personnel may be dangerous. The appliance shall be stored in a room without continuously operating ignition sources. (for example: open flames, an operating gas appliance or an operating electric heater.)

● Do not pierce or burn.

● Appliance shall be installed, operated and stored in a room with a floor area larger than "X" m² (see table a). (only applies to appliances that are not fixed appliances).

● Appliance filled with flammable gas R32. For repairs, strictly follow manufacturer's instructions only. Be aware that refrigerants not contain odour.

● Read specialist's manual.



Safety Operation of Flammable Refrigerant

Qualification requirement for installation and maintenance man

- All the work men who are engaging in the refrigeration system should bear the valid certification awarded by the authoritative organization and the qualification for dealing with the refrigeration system recognized by this industry. If it needs other technician to maintain and repair the appliance, they should be supervised by the person who bears the qualification for using the flammable refrigerant.
- It can only be repaired by the method suggested by the equipment's manufacturer.

Installation notes

- The air conditioner is not allowed to use in a room that has running fire (such as fire source, working coal gas ware, operating heater).
 - It is not allowed to drill hole or burn the connection pipe.
 - The air conditioner must be installed in a room that is larger than the minimum room area.
- The minimum room area is shown on the nameplate or following table a.
- Leak test is a must after installation.

table a - Minimum room area(m²)

Minimum room area(m ²)	Charge amount (kg)	≤1.2	1.3	1.4	1.5	1.6	1.7	1.8	1.9	2	2.1	2.2	2.3	2.4	2.5
	floor location	4	14.5	16.8	19.3	22	24.8	27.8	31	34.3	37.8	41.5	45.4	49.4	53.6
window mounted	4	5.2	6.1	7	7.9	8.9	10	11.2	12.4	13.6	15	16.3	17.8	19.3	
wall mounted	4	4	4	4	4	4	4	4	4	4	4.2	4.6	5	5.5	6
ceiling mounted	4	4	4	4	4	4	4	4	4	4	4	4	4	4	4

Maintenance notes

- Check whether the maintenance area or the room area meet the requirement of the nameplate.
 - It's only allowed to be operated in the rooms that meet the requirement of the nameplate.
- Check whether the maintenance area is well-ventilated.
 - The continuous ventilation status should be kept during the operation process.
- Check whether there is fire source or potential fire source in the maintenance area.
 - The naked flame is prohibited in the maintenance area; and the "no smoking" warning board should be hanged.
- Check whether the appliance mark is in good condition.
 - Replace the vague or damaged warning mark.

Welding

- If you should cut or weld the refrigerant system pipes in the process of maintaining, please follow the steps as below:
 - a. Shut down the unit and cut power supply
 - b. Eliminate the refrigerant
 - c. Vacuuming
 - d. Clean it with N₂ gas
 - e. Cutting or welding
 - f. Carry back to the service spot for welding
- Make sure that there isn't any naked flame near the outlet of the vacuum pump and it's well-ventilated.
- The refrigerant should be recycled into the specialized storage tank.

Filling the refrigerant

- Use the refrigerant filling appliances specialized for R32. Make sure that different kinds of refrigerant won't contaminate with each other.
- The refrigerant tank should be kept upright at the time of filling refrigerant.
- Stick the label on the system after filling is finished (or haven't finished).
- Don't overfilling.
- After filling is finished, please do the leakage detection before test running; another time of leak detection should be done when it's removed.

Safety instructions for transportation and storage

- Please use the flammable gas detector to check before unload and open the container.
- No fire source and smoking.
- According to the local rules and laws.

8. Installation

8.1 Installation Dimension Diagram

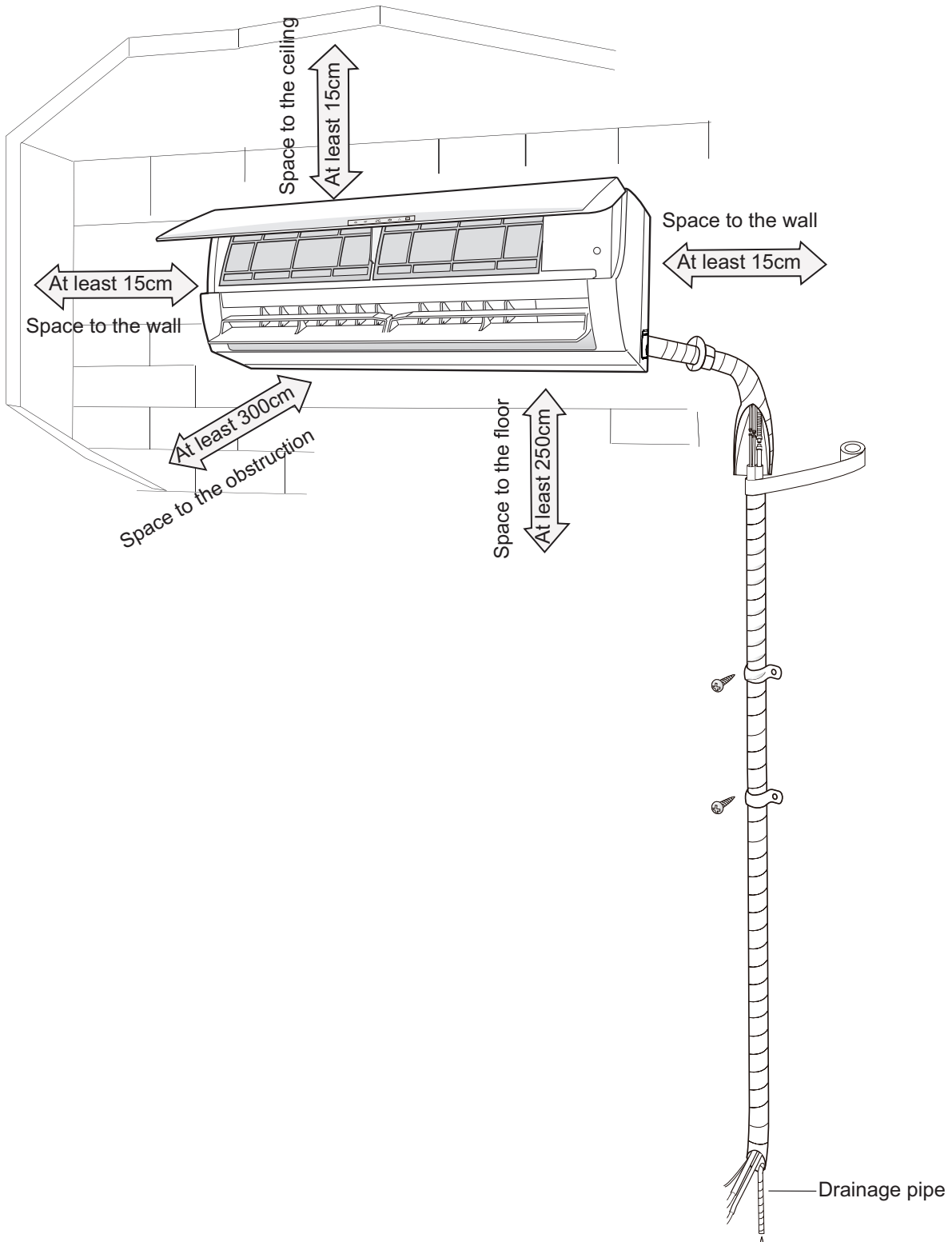

8.2 Installation Parts-checking

No.	Name	No.	Name
1	Indoor unit	8	Sealing gum
2	Outdoor unit	9	Wrapping tape
3	Connection pipe	10	Support of outdoor unit
4	Drainage pipe	11	Fixing screw
5	Wall-mounting frame	12	Drainage plug(cooling and heating unit)
6	Connecting cable(power cord)	13	Owner's manual, remote controller
7	Wall pipe		

⚠ Note:

- 1.Please contact the local agent for installation.
- 2.Don't use unqualified power cord.

8.3 Selection of Installation Location

1. Basic Requirement:

Installing the unit in the following places may cause malfunction. If it is unavoidable, please consult the local dealer:

- (1) The place with strong heat sources, vapors, flammable or explosive gas, or volatile objects spread in the air.
- (2) The place with high-frequency devices (such as welding machine, medical equipment).
- (3) The place near coast area.
- (4) The place with oil or fumes in the air.
- (5) The place with sulfured gas.
- (6) Other places with special circumstances.
- (7) Do not use the unit in the immediate surroundings of a laundry a bath a shower or a swimming pool.
- (8) It's not allowed to be installed on the unstable or motive base structure(such as truck) or in the corrosive environment (such as chemical factory).

2. Indoor Unit:

- (1) There should be no obstruction near air inlet and air outlet.
- (2) Select a location where the condensation water can be dispersed easily and won't affect other people.
- (3) Select a location which is convenient to connect the outdoor unit and near the power socket.
- (4) Select a location which is out of reach for children.
- (5) The location should be able to withstand the weight of indoor unit and won't increase noise and vibration.
- (6) The appliance must be installed 2.5m above floor.
- (7) Don't install the indoor unit right above the electric appliance.
- (8) Please try your best to keep way from fluorescent lamp.

8.4 Requirements for electric connection

1. Safety Precaution

- (1) Must follow the electric safety regulations when installing the unit.
- (2) According to the local safety regulations, use qualified power supply circuit and air switch.
- (3) Make sure the power supply matches with the requirement of air conditioner. Unstable power supply or incorrect wiring may result in electric shock, fire hazard or malfunction. Please install proper power supply cables before using the air conditioner.
- (4) Properly connect the live wire, neutral wire and grounding wire of power socket.
- (5) Be sure to cut off the power supply before proceeding any work related to electricity and safety.
- (6) Do not put through the power before finishing installation.
- (7) If the supply cord is damaged, it must be replaced by the manufacturer, its service agent or similarly qualified persons in order to avoid a hazard.
- (8) The temperature of refrigerant circuit will be high, please keep the interconnection cable away from the copper tube.
- (9) The appliance shall be installed in accordance with national wiring regulations.
- (10) Appliance shall be installed, operated and stored in a room with a floor area larger than "X"m² (see table a).



Please notice that the unit is filled with flammable gas R32. Inappropriate treatment of the unit involves the risk of severe damages of people and material. Details to this refrigerant are found in chapter "refrigerant".

2. Grounding Requirement:

- (1) The air conditioner is first class electric appliance. It must be properly grounding with specialized grounding device by a professional. Please make sure it is always grounded effectively, otherwise it may cause electric shock.
- (2) The yellow-green wire in air conditioner is grounding wire, which can't be used for other purposes.
- (3) The grounding resistance should comply with national electric safety regulations.
- (4) The appliance must be positioned so that the plug is accessible.
- (5) An all-pole disconnection switch having a contact separation of at least 3mm in all poles should be connected in fixed wiring.

8.5 Installation of Indoor Unit

1. Choosing Installation location

Recommend the installation location to the client and then confirm it with the client.

2. Install Wall-mounting Frame

- (1) Hang the wall-mounting frame on the wall; adjust it in horizontal position with the level meter and then point out the screw fixing holes on the wall.
- (2) Drill the screw fixing holes on the wall with impact drill (the specification of drill head should be the same as the plastic expansion particle) and then fill the plastic expansion particles in the holes.
- (3) Fix the wall-mounting frame on the wall with tapping screws and then check if the frame is firmly installed by pulling the frame. If the plastic expansion particle is loose, please drill another fixing hole nearby.

3. Install Wall-mounting Frame

(1) Choose the position of piping hole according to the direction of outlet pipe. The position of piping hole should be a little lower than the wall-mounted frame.(As show in Fig.1)

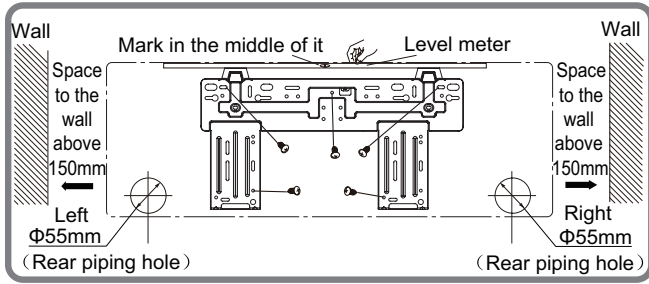

Fig.1

(2) Open a piping hole with the diameter of Φ55mm on the selected outlet pipe position. In order to drain smoothly, slant the piping hole on the wall slightly downward to the outdoor side with the gradient of 5-10°. (As show in Fig.2)

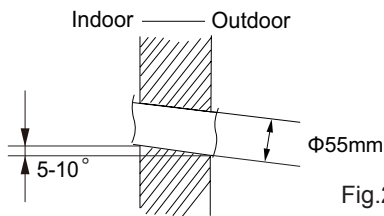

Fig.2

⚠ Note:

(1) Pay attention to dust prevention and take relevant safety measures when opening the hole.

4. Outlet Pipe

(1) The pipe can be led out in the direction of right, rear right, left or rear left. (As show in Fig.3)
 (2) When selecting leading out the pipe from left or right, please cut off the corresponding hole on the bottom case. (As show in Fig.4)

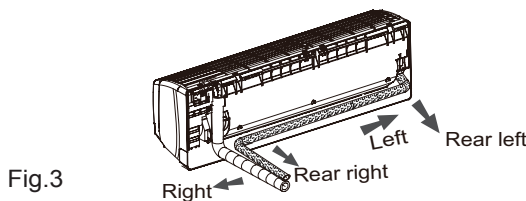

Fig.3

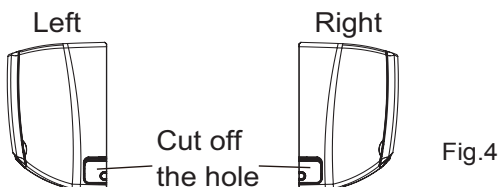

Fig.4

5. Connect the Pipe of Indoor Unit

(1) Aim the pipe joint at the corresponding bellmouth. (As show in Fig.5)
 (2) Pretightening the union nut with hand.
 (3) Adjust the torque force by referring to the following sheet. Place the open-end wrench on the pipe joint and place the torque wrench on the union nut. Tighten the union nut with torque wrench. (As show in Fig.6)
 (4) Wrap the indoor pipe and joint of connection pipe with insulating pipe, and then wrap it with tape. (As show in Fig.7)

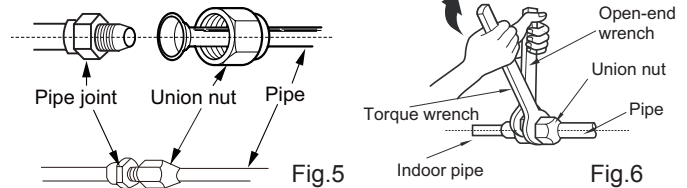

Fig.5

Fig.6

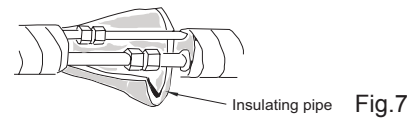

Fig.7

Refer to the following table for wrench moment of force:

Hex nut diameter(mm)	Tightening torque(N·m)
Φ6	15~20
Φ9.52	30~40
Φ12	45~55
Φ16	60~65
Φ19	70~75

6. Install Drain Hose

(1) Connect the drain hose to the outlet pipe of indoor unit. (As show in Fig.8)
 (2) Bind the joint with tape. (As show in Fig.9)

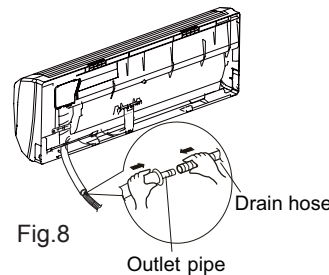

Fig.8

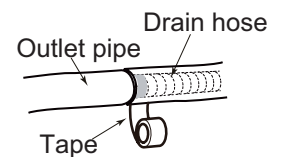

Fig.9

⚠ Note:

(1) Add insulating pipe in the indoor drain hose in order to prevent condensation.
 (2) The plastic expansion particles are not provided. (As show in Fig.10)

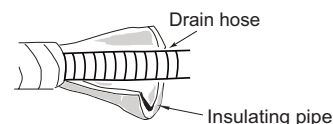

Fig.10

7. Connect Wire of Indoor Unit

(1) Open the panel, remove the screw on the wiring cover and then take down the cover.(As show in Fig.11)

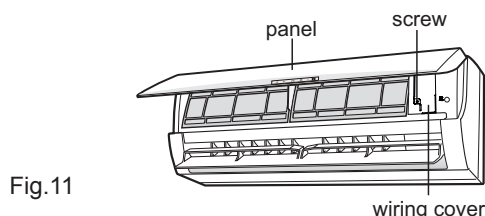

Fig.11

(2) Make the power connection wire go through the cable-cross hole at the back of indoor unit and then pull it out from the front side.(As show in Fig.12)

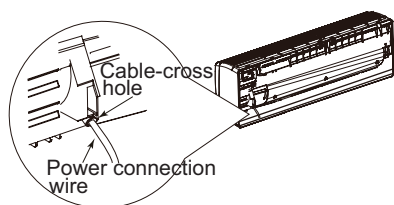

Fig.12

(3) Remove the wire clip; connect the power connection wire to the wiring terminal according to the color; tighten the screw and then fix the power connection wire with wire clip.(As show in Fig.13)

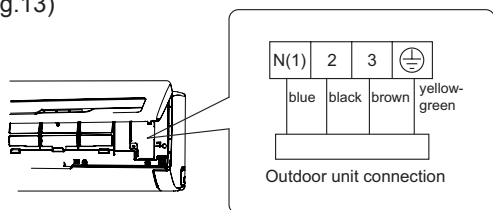

Fig.13

Note: The wiring connect is for reference only, please refer to the actual one.

(4) Put wiring cover back and then tighten the screw.
(5) Close the panel.

⚠ Note:

- (1) All wires of indoor unit and outdoor unit should be connected by a professional.
- (2) If the length of power connection wire is insufficient, please contact the supplier for a new one. Avoid extending the wire by yourself.
- (3) For the air conditioner with plug, the plug should be reachable after finishing installation.
- (4) For the air conditioner without plug, an air switch must be installed in the line. The air switch should be all-pole parting and the contact parting distance should be more than 3mm.

8. Bind up Pipe

- (1) Bind up the connection pipe, power cord and drain hose with the band.(As show in Fig.14)
- (2) Reserve a certain length of drain hose and power cord for installation when binding them. When binding to a certain degree, separate the indoor power and then separate the drain hose.(As show in Fig.15)
- (3) Bind them evenly.
- (4) The liquid pipe and gas pipe should be bound separately at the end.

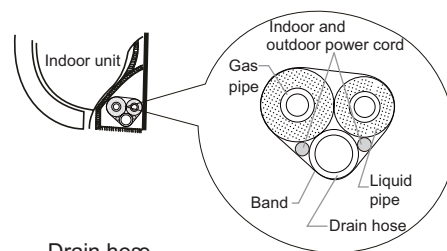

Fig.14

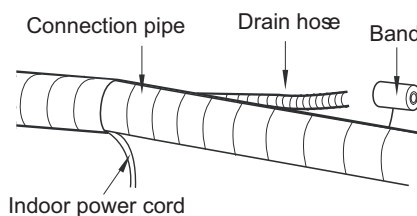

Fig.15

⚠ Note:

- (1) The power cord and control wire can't be crossed or winding.
- (2) The drain hose should be bound at the bottom.

9. Hang the Indoor Unit

- (1) Put the bound pipes in the wall pipe and then make them pass through the wall hole.
- (2) Hang the indoor unit on the wall-mounting frame.
- (3) Stuff the gap between pipes and wall hole with sealing gum.
- (4) Fix the wall pipe.(As show in Fig.16)
- (5) Check if the indoor unit is installed firmly and closed to the wall.(As show in Fig.17)

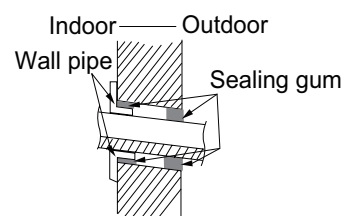

Fig.16

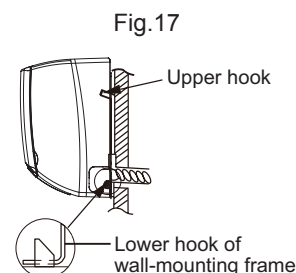

Fig.17

⚠ Note:

Do not bend the drain hose too excessively in order to prevent blocking.

8.6 Check after Installation and Test Operation

1. Check after Installation

Check according to the following requirement after finishing installation.

NO.	Items to be checked	Possible malfunction
1	Has the unit been installed firmly?	The unit may drop, shake or emit noise.
2	Have you done the refrigerant leakage test?	It may cause insufficient cooling (heating) capacity.
3	Is heat insulation of pipeline sufficient?	It may cause condensation and water dripping.
4	Is water drained well?	It may cause condensation and water dripping.
5	Is the voltage of power supply according to the voltage marked on the nameplate?	It may cause malfunction or damage the parts.
6	Is electric wiring and pipeline installed correctly?	It may cause malfunction or damage the parts.
7	Is the unit grounded securely?	It may cause electric leakage.
8	Does the power cord follow the specification?	It may cause malfunction or damage the parts.
9	Is there any obstruction in air inlet and air outlet?	It may cause insufficient cooling (heating) capacity.
10	The dust and sundries caused during installation are removed?	It may cause malfunction or damaging the parts.
11	The gas valve and liquid valve of connection pipe are open completely?	It may cause insufficient cooling (heating) capacity.
12	Is the inlet and outlet of piping hole been covered?	It may cause insufficient cooling (heating) capacity or waster eletricity.

2. Test Operation

(1) Preparation of test operation

- The client approves the air conditioner installation.
- Specify the important notes for air conditioner to the client.

(2) Method of test operation

- Put through the power, press ON/OFF button on the remote controller to start operation.
- Press MODE button to select AUTO, COOL, DRY, FAN and HEAT to check whether the operation is normal or not.
- If the ambient temperature is lower than 16°C , the air conditioner can't start cooling.

9. Maintenance

9.1 Error Code

1. Malfunction display requirement

When there are several malfunctions, they will be displayed circularly.

2. Malfunction display method

(1) Hardware malfunction: immediate display; refer to “error code list”;

(2) Operation state: immediate display; refer to “error code list”;

(3) Other malfunctions: it is displayed after the compressor stops for 200s; refer to “error code list”.

Note: when the compressor is restarted, the malfunction display delay time (200s) is cleared.

3. Malfunction display control

The indicator lamp and dual 8 nixie tube displays shall be synchronized. That is when the indicator lamp blinks, the dual 8 nixie tube displays the corresponding malfunction code.

4. Display control viaremote controller

Enter display control: press light button successively for 4 times within 3s to display the corresponding malfunction code;

Exit display control: pressing light button successively for 4 times within 3s or after display is shown for 5min, the display will terminate.

Error Code List

Malfunction Name	Malfunction types	Dual-8 Nixie Tube	Indicator Display		
			Operation indicator	Cooling indicator	Heating indicator
Fault in input power zero	Hardware malfunction	U8	blink 17 times		
Jumper cap malfunction protection	Hardware malfunction	C5	blink 15 times		
No feedback of indoor fan motor	Hardware malfunction	H6	blink 11 times		
Indoor ambient sensor open or short circuit	Hardware malfunction	F1		blink once	
Indoor tube sensor open or short circuit	Hardware malfunction	F2		blink twice	
Inlet tube sensor malfunction	Hardware malfunction	b5		blink 19 times	
Outlet tube sensor malfunction	Hardware malfunction	b7		blink 22 times	
IPM sensor circuit malfunction	Hardware malfunction	P7			blink 18 times
Outdoor ambient sensor open or short circuit	Hardware malfunction	F3		blink 3 times	
Inlet pipe temperature sensor of outdoor condenser is open-circuit/short circuit(commercial air con)	Hardware malfunction	A5			
Outdoor tube sensor open or short circuit	Hardware malfunction	F4		blink 4 times	
outlet pipe temperature sensor of outdoor condenser is open-circuit/short circuit(commercial air con)	Hardware malfunction	A7			
Exhaust sensor open or short circuit	Hardware malfunction	F5		blink 5 times	
Communication failure between indoor unit and outdoor unit	Hardware malfunction	E6	blink 6 times		
Compressor phase current detection circuit malfunction	Hardware malfunction	U1			blink 12 times
Compressor demagnetization protection	It can be displayed through remote controller within 200s and displayed directly after 200s	HE			blink 14 times
PN voltage drop protection		U3			blink 20 times
IPM high temperature protection		P8			blink 19 times
Refrigerant-lacking or blockage protection		F0		blink 10 times	
Capacitor charge malfunction	Hardware malfunction	PU			blink 17 times
Refrigerant system high pressure protection	Hardware malfunction	E1	blink once		
system low-pressure protection (reserved)	Hardware malfunction	E3	blink 3 times		
Compressor over load protection	It can be displayed through remote controller within 200s and displayed directly after 200s	H3			blink 3 times
Fault in matching	Hardware malfunction	LP	blink 19 times		
Loading EEPROM malfunction	Hardware malfunction	EE			blink 15 times
AC current detect circuit malfunction	Hardware malfunction	U5		blink 13 times	
Outdoor DC fan motor malfunction	Hardware malfunction	L3	blink 23 times		
Mode conflict	operation status	E7	blink 7 times		

Recovery refrigerant mode	operation status	Fo	blink once	blink once	
Startup failure	It can be displayed through remote controller within 200s and displayed directly after 200s	Lc			blink 11 times
Compressor exhaust high temperature protection		E4	blink 4 times		
Anti-high temperature protection		E8	blink 8 times		
AC over-current protection		E5	blink 5 times		
Over compressor phase current protection		P5			blink 15 times
Compressor loss step protection		H7			blink 7 times
Compressor loss of phase protection		Ld			
IPM protection		H5			blink 5 times
Low PN voltage protection		PL			blink 21 times
Over voltage protection for PN		PH		blink 11 times	
4-way valve reversal abnormal		U7		blink 20 times	
Malfunction of detecting plate(WIFI)	Hardware malfunction	JF			

Note: Please refer to service manual for the troubleshooting procedure for outdoor unit.

1. Malfunction of Temperature Sensor F1, F2

Main detection points:

- Is the wiring terminal between the temperature sensor and the controller loosened or poorly contacted?
- Is there short circuit due to trip-over of the parts?
- Is the temperature sensor broken?
- Is mainboard broken?

Malfunction diagnosis process:

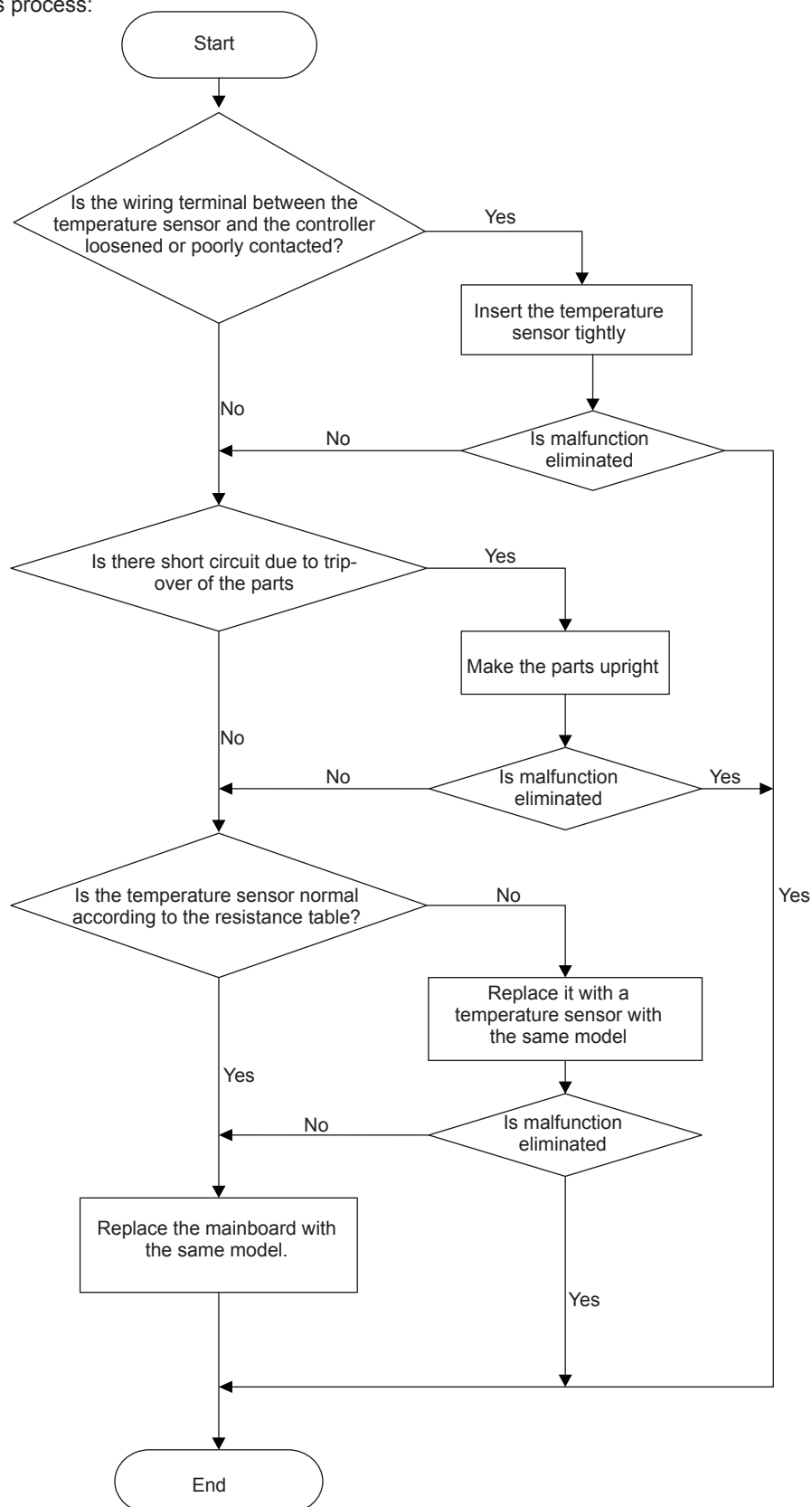

2. Malfunction of Blocked Protection of IDU Fan Motor H6

Main detection points:

- SmoothlyIs the control terminal of PG motor connected tightly?
- SmoothlyIs the feedback interface of PG motor connected tightly?
- The fan motor can't operate?
- The motor is broken?
- Detectioncircuit of the mainboard is defined abnormal?

Malfunction diagnosis process:

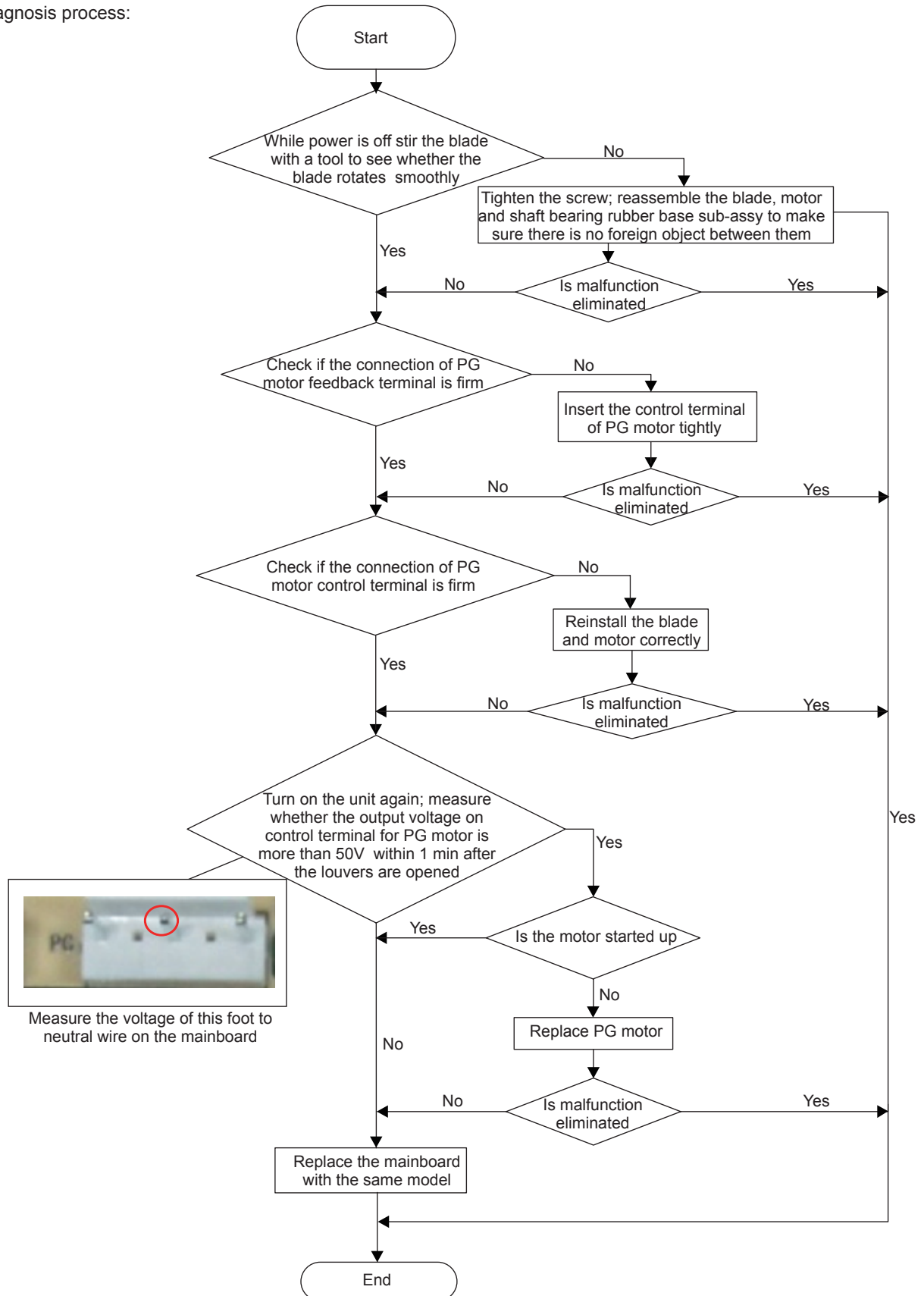

3. Malfunction of Protection of Jumper Cap C5

Main detection points:

- Is there jumper cap on the mainboard?
- Is the jumper cap inserted correctly and tightly?
- The jumper is broken?
- The motor is broken?
- Detection circuit of the mainboard is defined abnormal?

Malfunction diagnosis process:

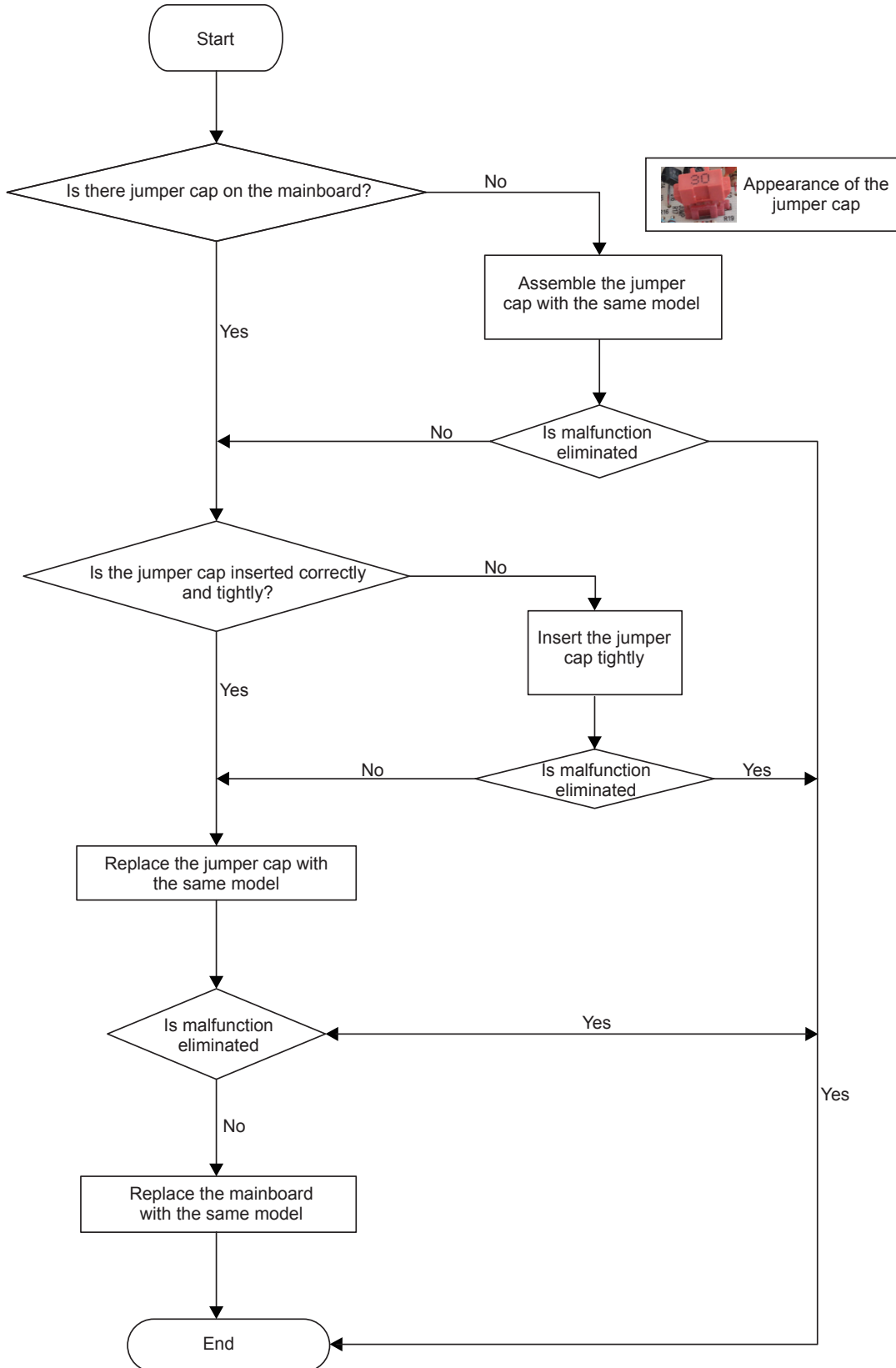

5. Malfunction of Overcurrent Protection E5

Main detection points:

- Is the supply voltage unstable with big fluctuation?
- Is the supply voltage too low with overload?
- Hardware trouble?

Malfunction diagnosis process:

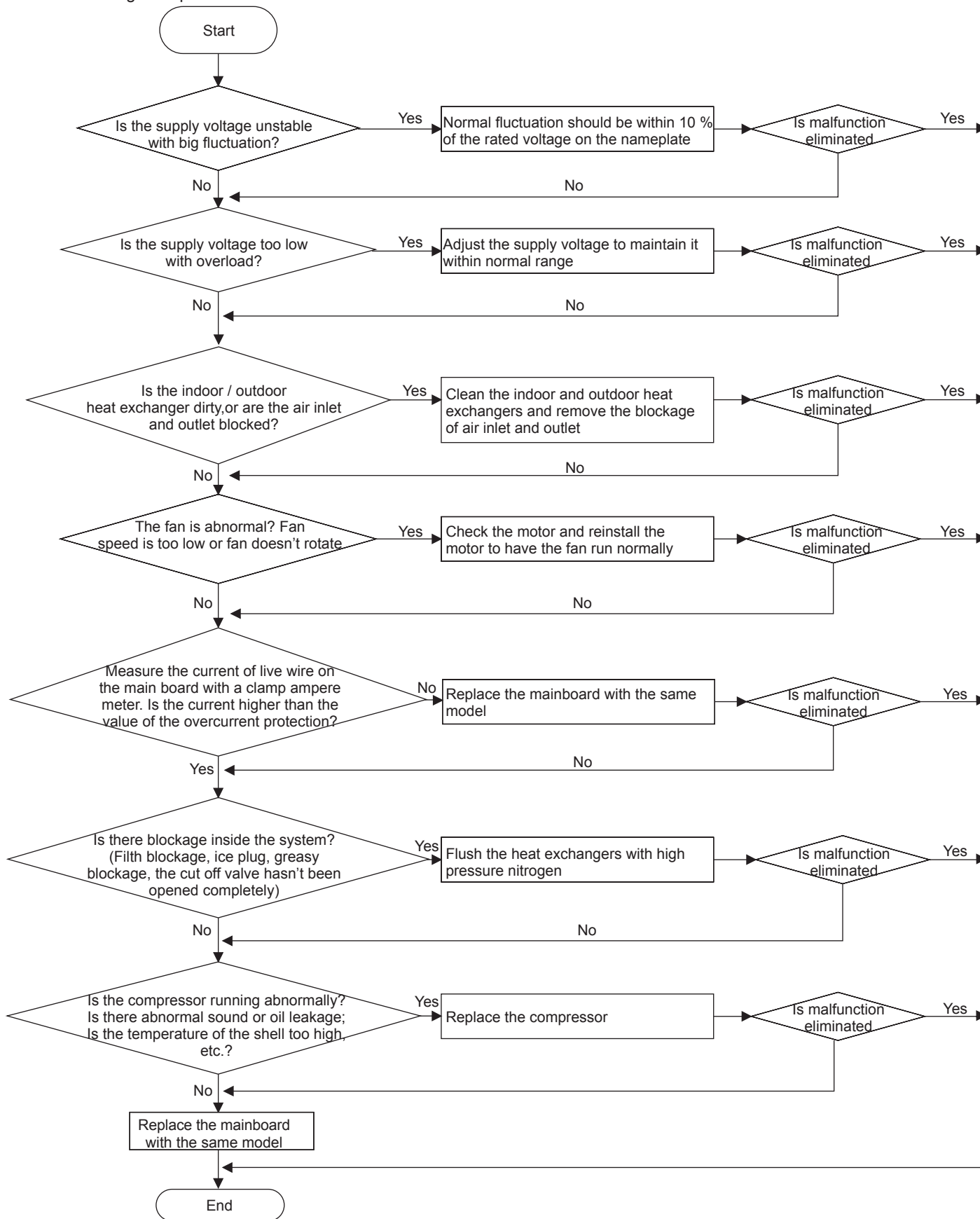

6. High temperature and overload protection (AP1 below means control board of outdoor unit) E8

Main detection points:

- If the outdoor ambient temperature is in normal range;
- If the indoor and outdoor fan are running normally;
- If the radiating environment of indoor and outdoor unit is good.

Malfunction diagnosis process:

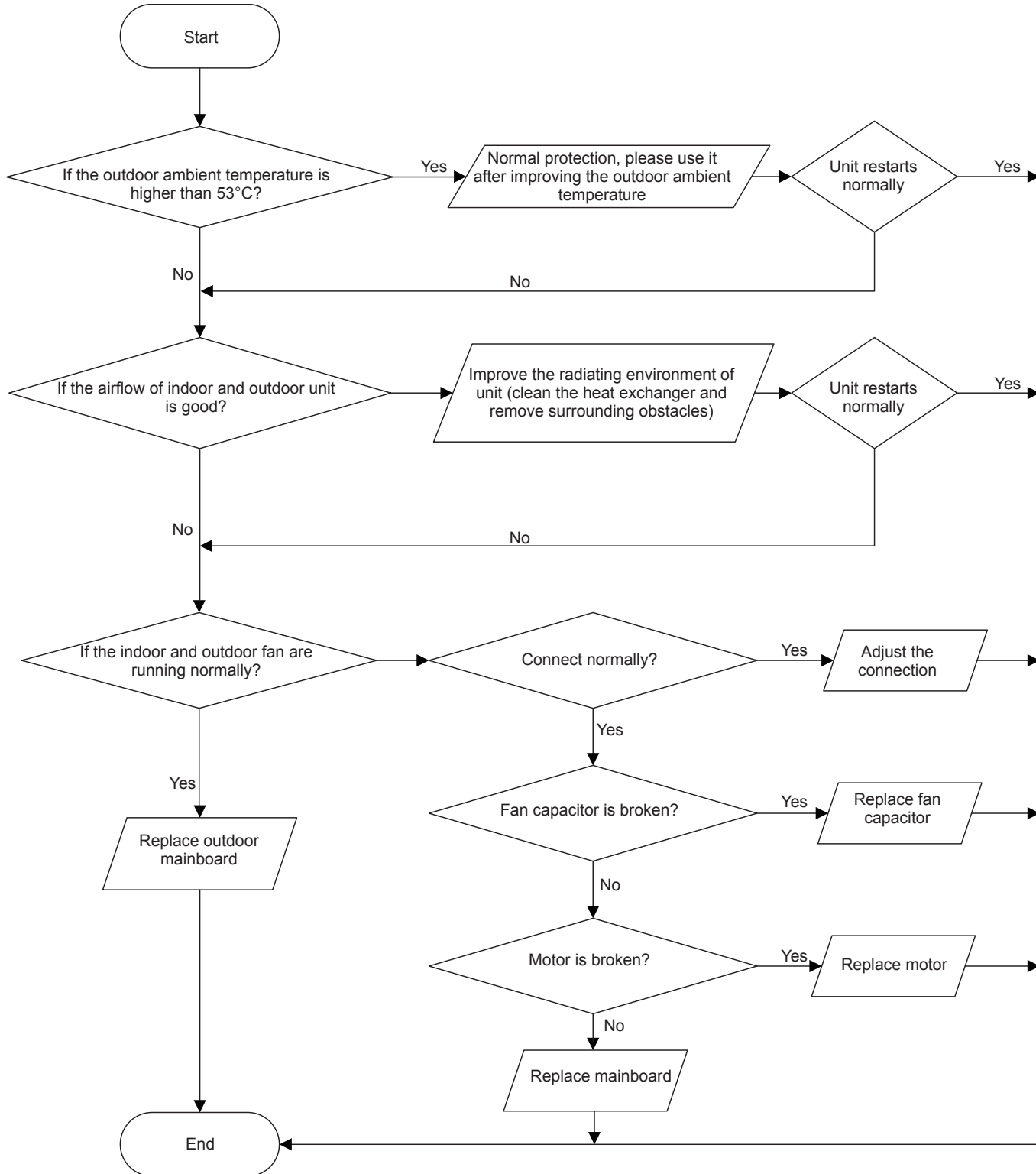

7. Overload Protection Compressor H3

Main detection points:

- Heat exchange of unit is not good? (heat exchanger is dirty and unit radiating environment is bad)
- Fan motor is not working?
- Too much load of the system causes high temperature of compressor after working for a long time?
- Whether high pressure switch is normal?
- If the refrigerant is leaked?

Malfunction diagnosis process:

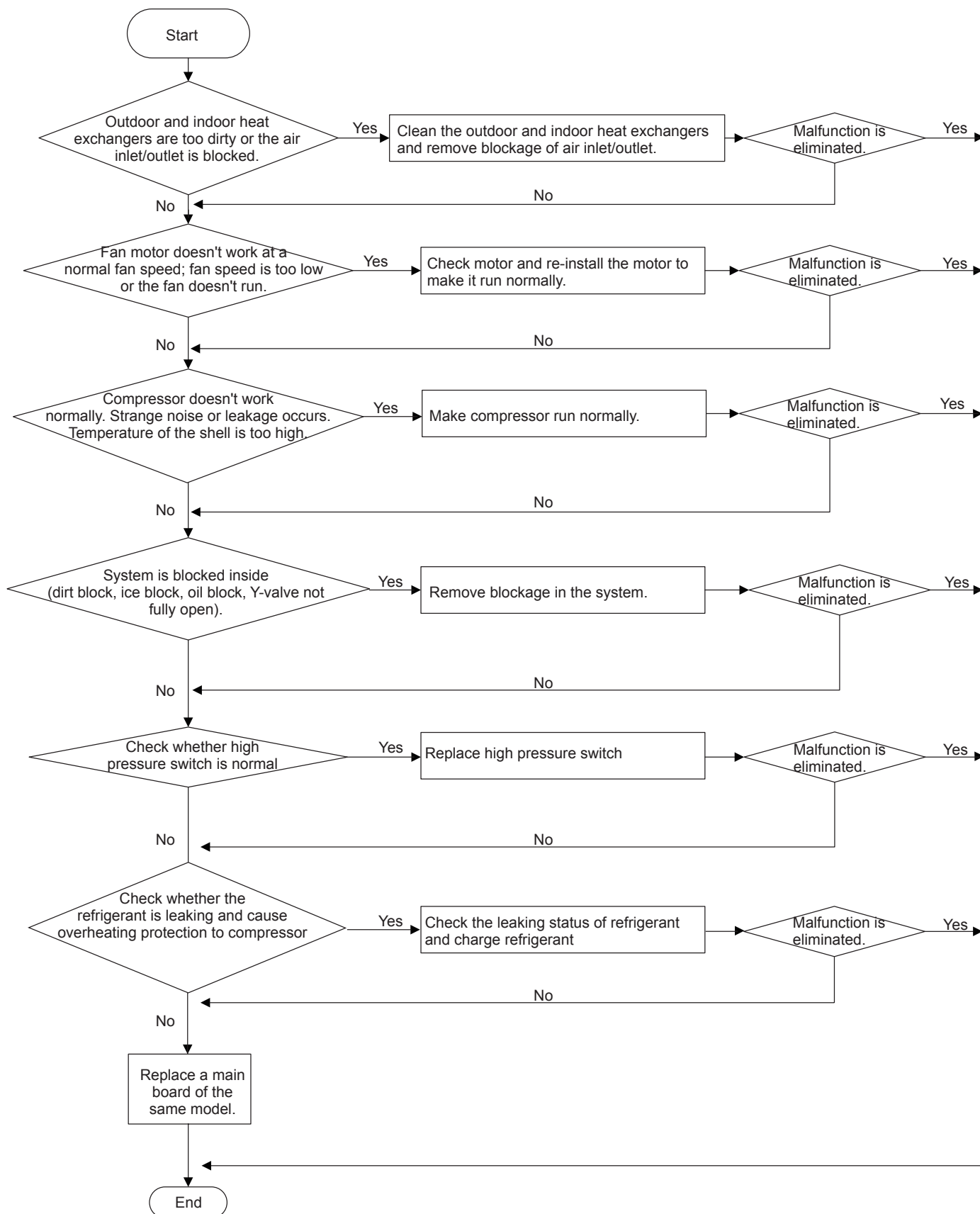

9.2 Maintenance Method for Normal Malfunction

1. Air Conditioner Can't be Started Up

Possible Causes	Discriminating Method (Air conditioner Status)	Troubleshooting
No power supply, or poor connection for power plug	After energization, operation indicator isn't bright and the buzzer can't give out sound	Confirm whether it's due to power failure. If yes, wait for power recovery. If not, check power supply circuit and make sure the power plug is connected well.
Wrong wire connection between indoor unit and outdoor unit, or poor connection for wiring terminals	Under normal power supply circumstances, operation indicator isn't bright after energization	Check the circuit according to circuit diagram and connect wires correctly. Make sure all wiring terminals are connected firmly
Electric leakage for air conditioner	After energization, room circuit breaker trips off at once	Make sure the air conditioner is grounded reliably Make sure wires of air conditioner is connected correctly Check the wiring inside air conditioner. Check whether the insulation layer of power cord is damaged; if yes, place the power cord.
Model selection for air switch is improper	After energization, air switch trips off	Select proper air switch
Malfunction of remote controller	After energization, operation indicator is bright, while no display on remote controller or buttons have no action.	Replace batteries for remote controller Repair or replace remote controller

2. Poor Cooling (Heating) for Air Conditioner

Possible Causes	Discriminating Method (Air conditioner Status)	Troubleshooting
Set temperature is improper	Observe the set temperature on remote controller	Adjust the set temperature
Rotation speed of the IDU fan motor is set too low	Small wind blow	Set the fan speed at high or medium
Filter of indoor unit is blocked	Check the filter to see it's blocked	Clean the filter
Installation position for indoor unit and outdoor unit is improper	Check whether the installation position is proper according to installation requirement for air conditioner	Adjust the installation position, and install the rainproof and sunproof for outdoor unit
Refrigerant is leaking	Discharged air temperature during cooling is higher than normal discharged wind temperature; Discharged air temperature during heating is lower than normal discharged wind temperature; Unit's pressure is much lower than regulated range	Find out the leakage causes and deal with it. Add refrigerant.
Malfunction of 4-way valve	Blow cold wind during heating	Replace the 4-way valve
Malfunction of capillary	Discharged air temperature during cooling is higher than normal discharged wind temperature; Discharged air temperature during heating is lower than normal discharged wind temperature; Unit's pressure is much lower than regulated range. If refrigerant isn't leaking, part of capillary is blocked	Replace the capillary
Flow volume of valve is insufficient	The pressure of valves is much lower than that stated in the specification	Open the valve completely
Malfunction of horizontal louver	Horizontal louver can't swing	Refer to point 3 of maintenance method for details
Malfunction of the IDU fan motor	The IDU fan motor can't operate	Refer to troubleshooting for H6 for maintenance method in details
Malfunction of the ODU fan motor	The ODU fan motor can't operate	Refer to point 4 of maintenance method for details
Malfunction of compressor	Compressor can't operate	Refer to point 5 of maintenance method for details

3. Horizontal Louver Can't Swing

Possible Causes	Discriminating Method (Air conditioner Status)	Troubleshooting
Wrong wire connection, or poor connection	Check the wiring status according to circuit diagram	Connect wires according to wiring diagram to make sure all wiring terminals are connected firmly
Stepping motor is damaged	Stepping motor can't operate	Repair or replace stepping motor
Main board is damaged	Others are all normal, while horizontal louver can't operate	Replace the main board with the same model

4. ODU Fan Motor Can't Operate

Possible causes	Discriminating method (air conditioner status)	Troubleshooting
Wrong wire connection, or poor connection	Check the wiring status according to circuit diagram	Connect wires according to wiring diagram to make sure all wiring terminals are connected firmly
Capacity of the ODU fan motor is damaged	Measure the capacity of fan capacitor with an universal meter and find that the capacity is out of the deviation range indicated on the nameplate of fan capacitor.	Replace the capacity of fan
Power voltage is a little low or high	Use universal meter to measure the power supply voltage. The voltage is a little high or low	Suggest to equip with voltage regulator
Motor of outdoor unit is damaged	When unit is on, cooling/heating performance is bad and ODU compressor generates a lot of noise and heat.	Change compressor oil and refrigerant. If no better, replace the compressor with a new one

5. Compressor Can't Operate

Possible causes	Discriminating method (air conditioner status)	Troubleshooting
Wrong wire connection, or poor connection	Check the wiring status according to circuit diagram	Connect wires according to wiring diagram to make sure all wiring terminals are connected firmly
Capacity of compressor is damaged	Measure the capacity of fan capacitor with an universal meter and find that the capacity is out of the deviation range indicated on the nameplate of fan capacitor.	Replace the compressor capacitor
Power voltage is a little low or high	Use universal meter to measure the power supply voltage. The voltage is a little high or low	Suggest to equip with voltage regulator
Coil of compressor is burnt out	Use universal meter to measure the resistance between compressor terminals and it's 0	Repair or replace compressor
Cylinder of compressor is blocked	Compressor can't operate	Repair or replace compressor

6. Air Conditioner is Leaking

Possible causes	Discriminating method (air conditioner status)	Troubleshooting
Drain pipe is blocked	Water leaking from indoor unit	Eliminate the foreign objects inside the drain pipe
Drain pipe is broken	Water leaking from drain pipe	Replace drain pipe
Wrapping is not tight	Water leaking from the pipe connection place of indoor unit	Wrap it again and bundle it tightly

7. Abnormal Sound and Vibration

Possible causes	Discriminating method (air conditioner status)	Troubleshooting
When turn on or turn off the unit, the panel and other parts will expand and there's abnormal sound	There's the sound of "PAPA"	Normal phenomenon. Abnormal sound will disappear after a few minutes.
When turn on or turn off the unit, there's abnormal sound due to flow of refrigerant inside air conditioner	Water-running sound can be heard	Normal phenomenon. Abnormal sound will disappear after a few minutes.
Foreign objects inside the indoor unit or there're parts touching together inside the indoor unit	There's abnormal sound fro indoor unit	Remove foreign objects. Adjust all parts' position of indoor unit, tighten screws and stick damping plaster between connected parts
Foreign objects inside the outdoor unit or there're parts touching together inside the outdoor unit	There's abnormal sound fro outdoor unit	Remove foreign objects. Adjust all parts' position of outdoor unit, tighten screws and stick damping plaster between connected parts
Short circuit inside the magnetic coil	During heating, the way valve has abnormal electromagnetic sound	Replace magnetic coil
Abnormal shake of compressor	Outdoor unit gives out abnormal sound	Adjust the support foot mat of compressor, tighten the bolts
Abnormal sound inside the compressor	Abnormal sound inside the compressor	If add too much refrigerant during maintenance, please reduce refrigerant properly. Replace compressor for other circumstances.

10. Exploded View and Parts List

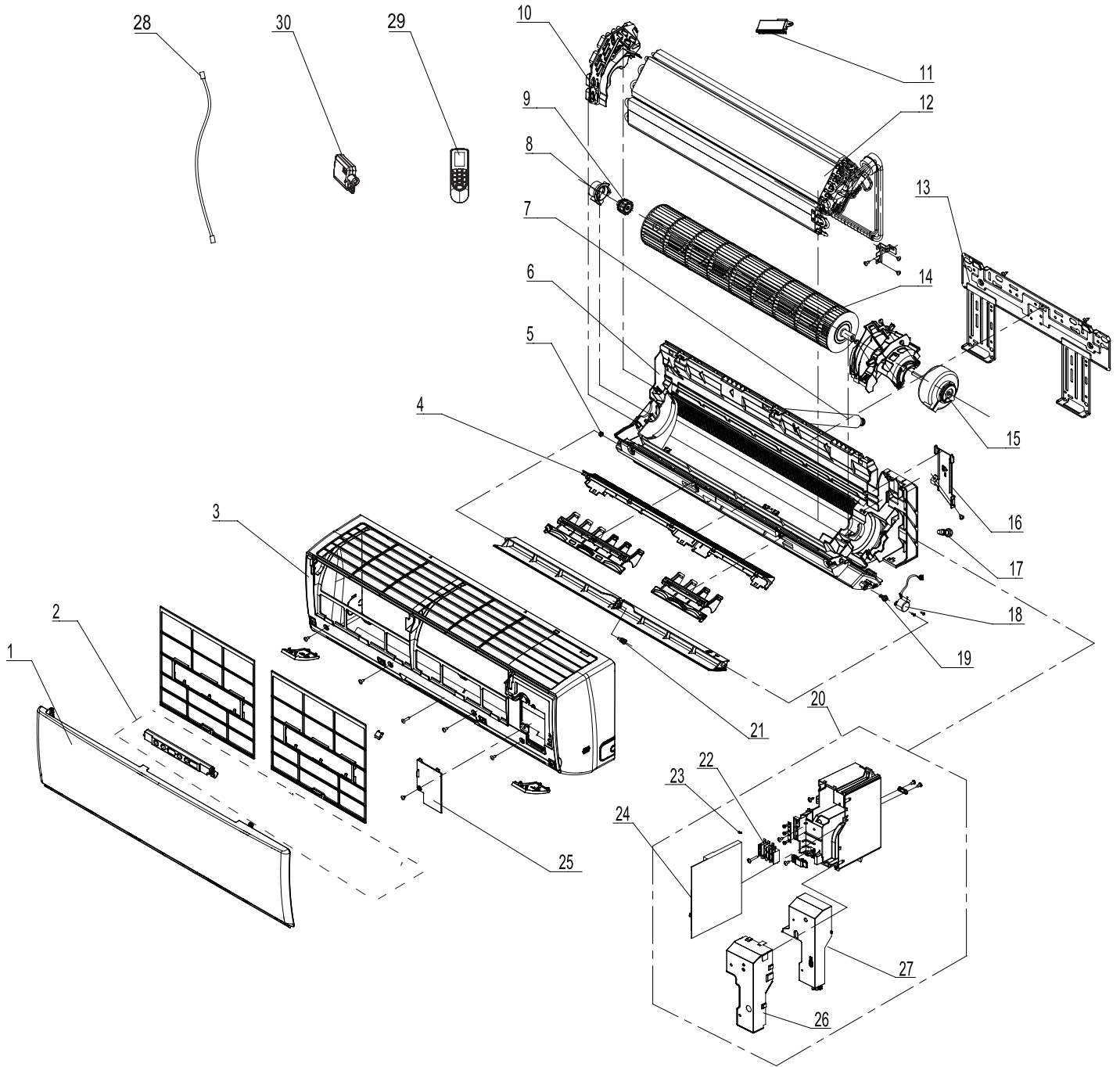

The component picture is only for reference; please refer to the actual product.

No.	Description	Part Code			Qty
		GWH(07)QB-K6DNA1A/I	GWH(07)QB-K6DND4A/I	GWH(07)QB-K6DNE6A/I	
	Product Code	CB419N12400	CB464N01300	CB465N01400	
1	Front Panel Assy	20022496	200003000075T	00000300007701	1
2	Display Board	30565231	300001000081	300001000035	1
3	Front Case Assy	20022495	00000200040	00000200040	1
4	Helicoid Tongue	26112508	26112508	26112508	1
5	Left Axile Bush	10512037	10512037	10512037	1
6	Rear Case assy	20162010	20162010	20162010	1
7	Drainage Hose	0523001408	0523001408	0523001408	1
8	Ring of Bearing	26152022	26152022	26152022	1
9	O-Gasket sub-assy of Bearing	7651205102	7651205102	7651205102	1
10	Evaporator Support	24212180	24212180	24212180	1
11	Cold Plasma Generator	1114001603	/	/	1
12	Evaporator Assy	0100200004406	0100200004407	0100200004407	1
13	Wall Mounting Frame	01252043	01252043	01252043	1
14	Cross Flow Fan	10352059	10352059	10352059	1
15	Fan Motor	150120874	150120874	150120874	1
16	Connecting pipe clamp	2611216401	2611216401	2611216401	1
17	Rubber Plug (Water Tray)	76712012	76712012	76712012	1
18	Stepping Motor	1521212901	1521212901	1521212901	1
19	Crank	73012005	73012005	73012005	1
20	Electric Box Assy	100002001192	100002003286	100002003284	1
21	Axile Bush	10542036	10542036	10542036	1
22	Terminal Board	42011233	42011233	42011233	1
23	Jumper	4202021901	4202021904	4202021904	1
24	Main Board	300002000288	300002000286	300002000286	1
25	Electric Box Cover Sub-Assy	0140206501	0140206501	0140206501	1
26	Shield Cover of Electric Box Cover	01592150	01592150	01592150	1
27	Electric Box Cover2	20112207	2011220801	2011220801	1
28	Connecting Cable	4002052317	4002052317	4002052317	0
29	Remote Controller	30510474	30510474	30510474	1
30	Detecting plate(WIFI)	30110154	30110154	30110154	1

Above data is subject to change without notice.

No.	Description	Part Code			Qty
		GWH(07)QB-K6DND6A/I	GWH(07)QB-K6DNC8A/I	GWH(07)QB-K6DNB6A/I	
	Product Code	CB460N05500	CB456N05800	CB435N09200	
1	Front Panel Assy	200003000028S	20000300155T	20000300050T	1
2	Display Board	300001000041	30565281	30565281	1
3	Front Case Assy	00000200040	00000200040	00000200040	1
4	Helicoid Tongue	26112508	26112508	26112508	1
5	Left Axile Bush	10512037	10512037	10512037	1
6	Rear Case assy	20162010	20162010	20162010	1
7	Drainage Hose	0523001408	0523001408	0523001408	1
8	Ring of Bearing	26152022	26152022	26152022	1
9	O-Gasket sub-assy of Bearing	7651205102	7651205102	7651205102	1
10	Evaporator Support	24212180	24212180	24212180	1
11	Cold Plasma Generator	1114001603	1114001603	1114001603	1
12	Evaporator Assy	0110010009505	0110010009505	0110010009505	1
13	Wall Mounting Frame	01252043	01252043	01252043	1
14	Cross Flow Fan	10352059	10352059	10352059	1
15	Fan Motor	150120874	150120874	150120874	1
16	Connecting pipe clamp	2611216401	2611216401	2611216401	1
17	Rubber Plug (Water Tray)	76712012	76712012	76712012	1
18	Stepping Motor	1521212901	1521212901	1521212901	1
19	Crank	73012005	73012005	73012005	1
20	Electric Box Assy	100002002891	100002003076	100002003076	1
21	Axile Bush	10542036	10542036	10542036	1
22	Terminal Board	42011233	42011233	42011233	1
23	Jumper	4202021904	4202021904	4202021904	1
24	Main Board	300002000288	300002000288	300002000288	1
25	Electric Box Cover Sub-Assy	0140206501	0140206501	0140206501	1
26	Shield Cover of Electric Box Cover	01592150	01592150	01592150	1
27	Electric Box Cover2	2011220801	2011220801	2011220801	1
28	Connecting Cable	4002052317	4002052317	4002052317	0
29	Remote Controller	305001000087	305001000087	305001000087	1
30	Detecting plate(WIFI)	30110154	30110154	30110154	1

Above data is subject to change without notice.

No.	Description	Part Code			Qty
		GWH(07)QB-K6DNE4A/I	GWH(07)QB-K6DNB2A/I	GWH(07)QB-K6DNC4A/I	
	Product Code	CB470N02600	CB432N17500	CB444N09700	
1	Front Panel Assy	200003000065T	20000300019S	20000300105S	1
2	Display Board	300001000081	30565260	30565260	1
3	Front Case Assy	00000200040	00000200040	00000200040	1
4	Helicoid Tongue	26112508	26112508	26112508	1
5	Left Axile Bush	10512037	10512037	10512037	1
6	Rear Case assy	20162010	20162010	20162010	1
7	Drainage Hose	0523001408	0523001408	0523001408	1
8	Ring of Bearing	26152022	26152022	26152022	1
9	O-Gasket sub-assy of Bearing	7651205102	7651205102	7651205102	1
10	Evaporator Support	24212180	24212180	24212180	1
11	Cold Plasma Generator	1114001603	1114001603	/	1
12	Evaporator Assy	0110010009505	0110010009505	01100100095	1
13	Wall Mounting Frame	01252043	01252043	01252043	1
14	Cross Flow Fan	10352059	10352059	10352059	1
15	Fan Motor	150120874	150120874	150120874	1
16	Connecting pipe clamp	2611216401	2611216401	2611216401	1
17	Rubber Plug (Water Tray)	76712012	76712012	76712012	1
18	Stepping Motor	1521212901	1521212901	1521212901	1
19	Crank	73012005	73012005	73012005	1
20	Electric Box Assy	100002002491	100002003790	100002061266	1
21	Axile Bush	10542036	10542036	10542036	1
22	Terminal Board	42011233	42011233	42011233	1
23	Jumper	4202021904	4202021904	4202021904	1
24	Main Board	300002000288	300002000288	300002000286	1
25	Electric Box Cover Sub-Assy	0140206501	0140206501	0140206501	1
26	Shield Cover of Electric Box Cover	01592150	01592150	01592150	1
27	Electric Box Cover2	2011220801	2011220801	2011220801	1
28	Connecting Cable	4002052317	4002052317	4002052317	0
29	Remote Controller	305001000087	305001000087	305001000087	1
30	Detecting plate(WIFI)	30110154	30110154	30110154	1

Above data is subject to change without notice.

No.	Description	Part Code			Qty
		GWH(07)QB-K6DNC2A/I	GWH(07)QB-K6DNA5A/I	GWH(07)QB-K6DNA2A/I	
	Product Code	CB439N12500	CB425N12100	CB426N06500	
1	Front Panel Assy	20000300068S	00000300036	20022719	1
2	Display Board	30565281	30565260	300001060082	1
3	Front Case Assy	00000200040	2002249501	2002273001	1
4	Helicoid Tongue	26112508	26112508	26112508	1
5	Left Axile Bush	10512037	10512037	10512037	1
6	Rear Case assy	20162010	20162010	20162010	1
7	Drainage Hose	0523001408	0523001408	0523001408	1
8	Ring of Bearing	26152022	26152022	26152022	1
9	O-Gasket sub-assy of Bearing	7651205102	7651205102	76512051	1
10	Evaporator Support	24212180	24212180	24212180	1
11	Cold Plasma Generator	1114001603	1114001603	1114001603	1
12	Evaporator Assy	0110010009505	0110010009505	0110010009505	1
13	Wall Mounting Frame	01252043	01252043	01252043	1
14	Cross Flow Fan	10352059	10352059	10352059	1
15	Fan Motor	150120874	150120874	150120874	1
16	Connecting pipe clamp	2611216401	2611216401	2611216401	1
17	Rubber Plug (Water Tray)	76712012	76712012	76712012	1
18	Stepping Motor	1521212901	1521212901	1521212901	1
19	Crank	73012005	73012005	73012005	1
20	Electric Box Assy	100002003076	100002061596	100002062497	1
21	Axile Bush	10542036	10542036	10542036	1
22	Terminal Board	42011233	42011233	42011233	1
23	Jumper	4202021904	4202021901	4202021904	1
24	Main Board	300002000288	300002000288	300002000288	1
25	Electric Box Cover Sub-Assy	0140206501	0140206501	0140206501	1
26	Shield Cover of Electric Box Cover	01592150	01592150	01592150	1
27	Electric Box Cover2	2011220801	2011220801	2011220801	1
28	Connecting Cable	4002052317	4002052317	4002052317	0
29	Remote Controller	305001000087	305001000087	305001000087	1
30	Detecting plate(WIFI)	30110154	30110154	30110154	1

Above data is subject to change without notice.

No.	Description	Part Code			Qty
		GWH(07)QB-K6DNC6A/I	GWH(07)QB-K6DNC4A/I	GWH(07)QB-K6DNB4A/I	
	Product Code	CB443N05500	CB444N09701	CB434N12800	
1	Front Panel Assy	20000300101T	20000300105S	20000300026T	1
2	Display Board	30565260	30565260	30565260	1
3	Front Case Assy	00000200040	00000200040	00000200040	1
4	Helicoid Tongue	26112508	26112508	26112508	1
5	Left Axile Bush	10512037	10512037	10512037	1
6	Rear Case assy	20162010	20162010	20162010	1
7	Drainage Hose	0523001408	0523001408	0523001408	1
8	Ring of Bearing	26152022	26152022	26152022	1
9	O-Gasket sub-assy of Bearing	76512051	76512051	76512051	1
10	Evaporator Support	24212180	24212180	24212180	1
11	Cold Plasma Generator	1114001603	1114001603	1114001603	1
12	Evaporator Assy	0110010009505	0110010009505	0110010009505	1
13	Wall Mounting Frame	01252043	01252043	01252043	1
14	Cross Flow Fan	10352059	10352059	10352059	1
15	Fan Motor	150120874	150120874	150120874	1
16	Connecting pipe clamp	2611216401	2611216401	2611216401	1
17	Rubber Plug (Water Tray)	76712012	76712012	76712012	1
18	Stepping Motor	1521212901	1521212901	1521212901	1
19	Crank	73012005	73012005	73012005	1
20	Electric Box Assy	100002003790	100002003790	100002003790	1
21	Axile Bush	10542036	10542036	10542036	1
22	Terminal Board	42011233	42011233	42011233	1
23	Jumper	4202021904	4202021904	4202021904	1
24	Main Board	300002000288	300002000288	300002000288	1
25	Electric Box Cover Sub-Assy	0140206501	0140206501	0140206501	1
26	Shield Cover of Electric Box Cover	01592150	01592150	01592150	1
27	Electric Box Cover2	2011220801	2011220801	2011220801	1
28	Connecting Cable	4002052317	4002052317	4002052317	0
29	Remote Controller	305001000087	305001000087	305001000087	1
30	Detecting plate(WIFI)	30110154	30110154	30110154	1

Above data is subject to change without notice.

No.	Description	Part Code			Qty
		GWH(07)QB-K6DND8A/I	GWH(07)QB-K6DNB6A/I	GWH(07)QB-K6DNE4A/I	
	Product Code	CB459N05400	CB435N09201	CB470N02601	
1	Front Panel Assy	00000300003701	200003000050T	200003000065T	1
2	Display Board	300001000035	30565281	300001000081	1
3	Front Case Assy	00000200040	00000200040	00000200040	1
4	Helicoid Tongue	26112508	26112508	26112508	1
5	Left Axile Bush	10512037	10512037	10512037	1
6	Rear Case assy	20162010	20162010	20162010	1
7	Drainage Hose	0523001408	0523001408	0523001408	1
8	Ring of Bearing	26152022	26152022	26152022	1
9	O-Gasket sub-assy of Bearing	76512051	76512051	76512051	1
10	Evaporator Support	24212180	24212180	24212180	1
11	Cold Plasma Generator	1114001603	/	/	1
12	Evaporator Assy	0110010009505	0100200004407	01100100095	1
13	Wall Mounting Frame	01252043	01252043	01252043	1
14	Cross Flow Fan	10352059	10352059	10352059	1
15	Fan Motor	150120874	150120874	150120874	1
16	Connecting pipe clamp	2611216401	2611216401	2611216401	1
17	Rubber Plug (Water Tray)	76712012	76712012	76712012	1
18	Stepping Motor	1521212901	1521212901	1521212901	1
19	Crank	73012005	73012005	73012005	1
20	Electric Box Assy	100002002490	100002064079	100002003286	1
21	Axile Bush	10542036	10542036	10542036	1
22	Terminal Board	42011233	42011233	42011233	1
23	Jumper	4202021904	4202021904	4202021904	1
24	Main Board	300002000288	300002000286	300002000286	1
25	Electric Box Cover Sub-Assy	0140206501	0140206501	0140206501	1
26	Shield Cover of Electric Box Cover	01592150	01592150	01592150	1
27	Electric Box Cover2	2011220801	2011220801	2011220801	1
28	Connecting Cable	4002052317	4002052317	4002052317	0
29	Remote Controller	305001000087	305001000087	305001000087	1
30	Detecting plate(WIFI)	30110154	30110154	30110154	1

Above data is subject to change without notice.

No.	Description	Part Code			Qty
		GWH(07)QB-K6DNA2A/I	GWH(07)QB-K6DNB4A/I	GWH(07)QB-K6DNB2A/I	
	Product Code	CB426N06501	CB434N12801	CB432N17501	
1	Front Panel Assy	20022719	20000300026T	20000300019	1
2	Display Board	300001060082	30565260	30565260	1
3	Front Case Assy	2002273001	00000200040	00000200040	1
4	Helicoid Tongue	26112508	26112508	26112508	1
5	Left Axile Bush	10512037	10512037	10512037	1
6	Rear Case assy	20162010	20162010	20162010	1
7	Drainage Hose	0523001408	0523001408	0523001408	1
8	Ring of Bearing	26152022	26152022	26152022	1
9	O-Gasket sub-assy of Bearing	76512051	76512051	76512051	1
10	Evaporator Support	24212180	24212180	24212180	1
11	Cold Plasma Generator	1114001603	/	/	1
12	Evaporator Assy	0110010009505	0110010009505	0110010009512	1
13	Wall Mounting Frame	01252043	01252043	01252043	1
14	Cross Flow Fan	10352059	10352059	10352059	1
15	Fan Motor	150120874	150120874	150120874	1
16	Connecting pipe clamp	2611216401	2611216401	2611216401	1
17	Rubber Plug (Water Tray)	76712012	76712012	76712012	1
18	Stepping Motor	1521212901	1521212901	1521212901	1
19	Crank	73012005	73012005	73012005	1
20	Electric Box Assy	100002062975	100002061266	100002061266	1
21	Axile Bush	10542036	10542036	10542036	1
22	Terminal Board	42011233	42011233	42011233	1
23	Jumper	4202021904	4202021904	4202021904	1
24	Main Board	300002000286	300002000286	300002000286	1
25	Electric Box Cover Sub-Assy	0140206501	0140206501	0140206501	1
26	Shield Cover of Electric Box Cover	01592150	01592150	01592150	1
27	Electric Box Cover2	2011220801	2011220801	2011220801	1
28	Connecting Cable	4002052317	4002052317	4002052317	0
29	Remote Controller	305001000087	305001000087	305001000087	1
30	Detecting plate(WIFI)	30110154	30110154	30110154	1

Above data is subject to change without notice.

No.	Description	Part Code		Qty
		GWH(07)QB-K6DNB8A/I	GWH(07)QB-K6DND8A/I	
	Product Code	CB438N10700	CB459N05401	
1	Front Panel Assy	20000300073	00000300003701	1
2	Display Board	30565260	300001000035	1
3	Front Case Assy	00000200040	00000200040	1
4	Helicoid Tongue	26112508	26112508	1
5	Left Axile Bush	10512037	10512037	1
6	Rear Case assy	20162010	20162010	1
7	Drainage Hose	0523001408	0523001408	1
8	Ring of Bearing	26152022	26152022	1
9	O-Gasket sub-assy of Bearing	76512051	76512051	1
10	Evaporator Support	24212180	24212180	1
11	Cold Plasma Generator	/	/	/
12	Evaporator Assy	0100200004407	0100200004407	1
13	Wall Mounting Frame	01252043	01252043	1
14	Cross Flow Fan	10352059	10352059	1
15	Fan Motor	150120874	150120874	1
16	Connecting pipe clamp	2611216401	2611216401	1
17	Rubber Plug (Water Tray)	76712012	76712012	1
18	Stepping Motor	1521212901	1521212901	1
19	Crank	73012005	73012005	1
20	Electric Box Assy	100002061266	100002003284	1
21	Axile Bush	10542036	10542036	1
22	Terminal Board	42011233	42011233	1
23	Jumper	4202021904	4202021904	1
24	Main Board	300002000286	300002000286	1
25	Electric Box Cover Sub-Assy	0140206501	017053060075	1
26	Shield Cover of Electric Box Cover	01592150	01592150	1
27	Electric Box Cover2	2011220801	2011220801	1
28	Connecting Cable	4002052317	4002052317	0
29	Remote Controller	305001000087	305001000087	1
30	Detecting plate(WIFI)	30110154	30110154	1

Above data is subject to change without notice.

11. Removal Procedure

⚠ Caution: discharge the refrigerant completely before removal.

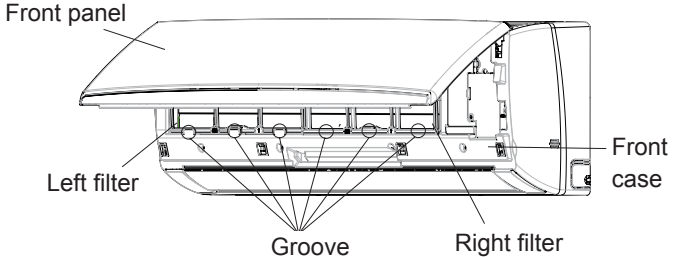
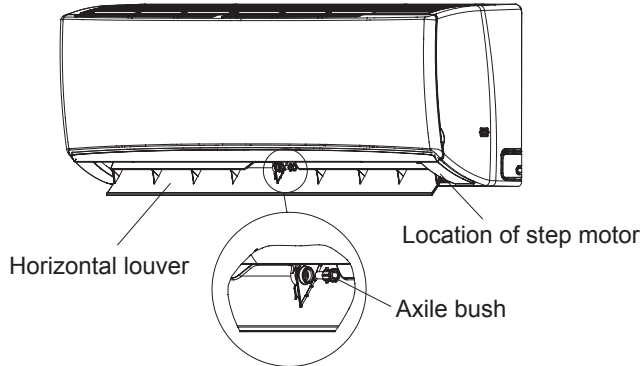
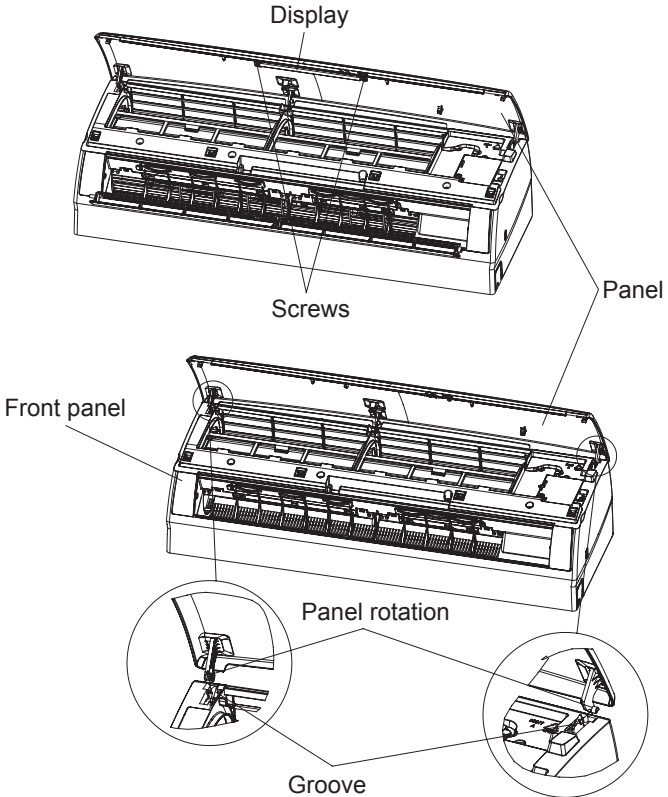
Step	Procedure
1.Remove filter assy	<p>Open the front panel. Push the left and right filters to make them break away from the groove on the front case. Then remove the left and right filters one by one.</p> 
2. Remove horizontal louver	<p>Push out the axle bush on horizontal louver. Bend the horizontal louver with hand and then separate the horizontal louver from the crankshaft of step motor to remove it.</p> 
3. Remove panel	<p>a Screw off the 2 screws that are locking the display board. Separate the display board from the front panel.</p> <p>b Separate the panel rotation shaft from the groove fixing the front panel and then removes the front panel.</p> 

Step	Procedure	Image
4. Remove electric box cover 2 and detecting plate(WIFI)	<p>Remove the screws on the electric box cover 2 and detecting plate(WIFI), then remove the electric box cover 2 and detecting plate(WIFI).</p>	
5. Remove front case sub-assy	<p>a Remove the screws fixing front case.</p> <p>Note: 1.Open the screw caps before removing the screws around the air outlet. 2.The quantity of screws fixing the front case sub-assy is different for different models.</p> <p>b Loosen the connection clasps between front case sub-assy and bottom case. Lift up the front case sub-assy and take it out.</p>	
6. Remove vertical louver	<p>Loosen the connection clasps between vertical louver and bottom case to remove vertical louver.</p>	

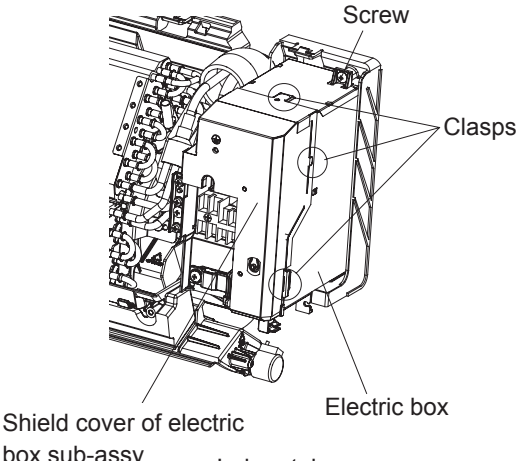
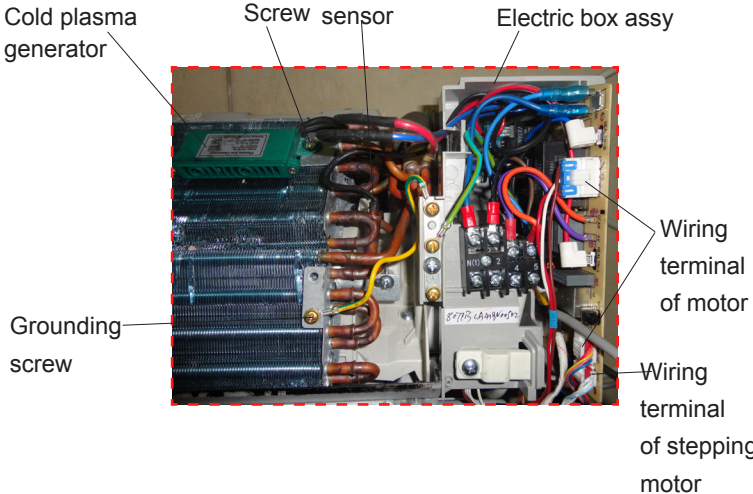
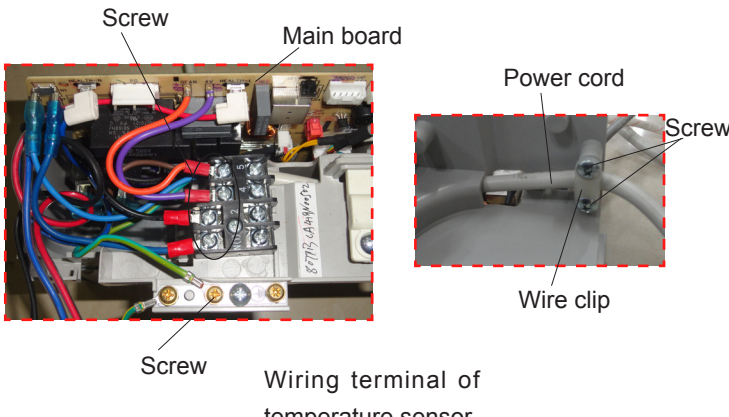
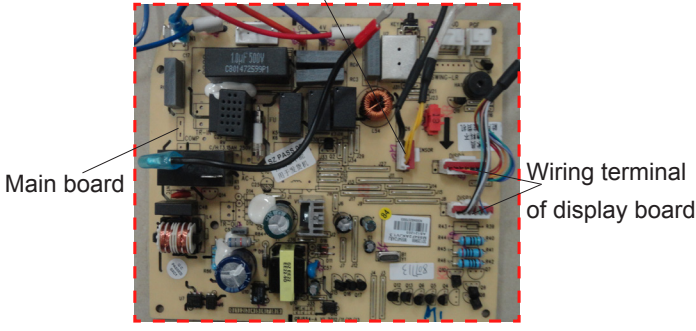
Step	Procedure
7. Remove electric box assy	
a	<p>Loosen the connection clasps between shield cover of electric box sub-assy and electric box, and then remove the shield cover of electric box sub-assy. Remove the screw fixing electric box assy .</p> 
b	<p>① Remove the cold plasma generator by screwing off one locking screw on the generator. ② Take off the indoor tube temperature sensor. ③ Screw off one grounding screw. ④ Remove the wiring terminals of motor and stepping motor. ⑤ Remove the electric box assy.</p> 
c	<p>Twist off the screws that are locking lead wire and rotate the electric box assy. Twist off the screws that are locking wire clip. Loosen the power cord and remove its wiring terminal. Lift up the main board and take it off.</p> 
d	<p>Remove the display board by taking out its wiring terminal. Remove temperature sensor by taking out its wiring terminal.</p> 

Step	Procedure	Image
	<p>Instruction: Some wiring terminal of this product is with lock catch and other devices. The pulling method is as below:</p> <p>1.Remove the soft sheath for some terminals at first, hold the circlip and then pull out the terminals.</p> <p>2.Pull out the holder for some terminals at first (holder is not available for some wiring terminal), hold the connector and then pull the terminal.</p>	<p>Circlip Soft sheath Holder Connector</p>
8. Remove evaporator assy		
a	Remove 3 screws fixing evaporator assy.	<p>Screws Evaporator assy</p>
b	At the back of the unit, remove the screw fixing connection pipe clamp and then remove the connection pipe clamp.	<p>Connection pipe clamp Screw</p>
c	First remove the left side of evaporator from the groove of bottom shell and then remove the right side from the clasp on the bottom shell.	<p>Groove Bottom shell Evaporator assy Clasp</p>
d	Adjust the position of connection pipe on evaporator slightly and then lift the evaporator upwards to remove it.	<p>Connection pipe</p>

Appendix:

Appendix 1: Reference Sheet of Celsius and Fahrenheit

Conversion formula for Fahrenheit degree and Celsius degree: $T_f = T_c \times 1.8 + 32$

Set temperature

Fahrenheit display temperature (°F)	Fahrenheit (°F)	Celsius (°C)	Fahrenheit display temperature (°F)	Fahrenheit (°F)	Celsius (°C)	Fahrenheit display temperature (°F)	Fahrenheit (°F)	Celsius (°C)
61	60.8	16	69/70	69.8	21	78/79	78.8	26
62/63	62.6	17	71/72	71.6	22	80/81	80.6	27
64/65	64.4	18	73/74	73.4	23	82/83	82.4	28
66/67	66.2	19	75/76	75.2	24	84/85	84.2	29
68	68	20	77	77	25	86	86	30

Ambient temperature

Fahrenheit display temperature (°F)	Fahrenheit (°F)	Celsius (°C)	Fahrenheit display temperature (°F)	Fahrenheit (°F)	Celsius (°C)	Fahrenheit display temperature (°F)	Fahrenheit (°F)	Celsius (°C)
32/33	32	0	55/56	55.4	13	79/80	78.8	26
34/35	33.8	1	57/58	57.2	14	81	80.6	27
36	35.6	2	59/60	59	15	82/83	82.4	28
37/38	37.4	3	61/62	60.8	16	84/85	84.2	29
39/40	39.2	4	63	62.6	17	86/87	86	30
41/42	41	5	64/65	64.4	18	88/89	87.8	31
43/44	42.8	6	66/67	66.2	19	90	89.6	32
45	44.6	7	68/69	68	20	91/92	91.4	33
46/47	46.4	8	70/71	69.8	21	93/94	93.2	34
48/49	48.2	9	72	71.6	22	95/96	95	35
50/51	50	10	73/74	73.4	23	97/98	96.8	36
52/53	51.8	11	75/76	75.2	24	99	98.6	37
54	53.6	12	77/78	77	25			

Appendix 2: Pipe Expanding Method

Note:

Improper pipe expanding is the main cause of refrigerant leakage. Please expand the pipe according to the following steps:

A: Cut the pipe

- Confirm the pipe length according to the distance of indoor unit and outdoor unit.
- Cut the required pipe with pipe cutter.

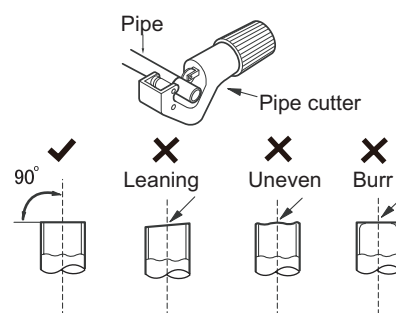

B: Remove the burrs

- Remove the burrs with shaper and prevent the burrs from getting into the pipe.

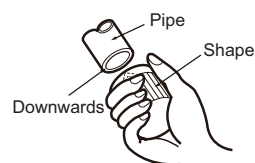

C: Put on suitable insulating pipe

D: Put on the union nut

- Remove the union nut on the indoor connection pipe and outdoor valve; install the union nut on the pipe.

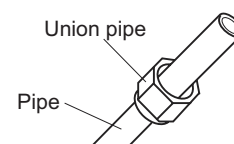

E: Expand the port

- Expand the port with expander.

Appendix 3: List of Resistance for Temperature Sensor

Resistance Table of Ambient Temperature Sensor for Indoor and Outdoor Units(15K)

Temp(°C)	Resistance(kΩ)	Temp(°C)	Resistance(kΩ)	Temp(°C)	Resistance(kΩ)	Temp(°C)	Resistance(kΩ)
-19	138.1	20	18.75	59	3.848	98	1.071
-18	128.6	21	17.93	60	3.711	99	1.039
-17	121.6	22	17.14	61	3.579	100	1.009
-16	115	23	16.39	62	3.454	101	0.98
-15	108.7	24	15.68	63	3.333	102	0.952
-14	102.9	25	15	64	3.217	103	0.925
-13	97.4	26	14.36	65	3.105	104	0.898
-12	92.22	27	13.74	66	2.998	105	0.873
-11	87.35	28	13.16	67	2.896	106	0.848
-10	82.75	29	12.6	68	2.797	107	0.825
-9	78.43	30	12.07	69	2.702	108	0.802
-8	74.35	31	11.57	70	2.611	109	0.779
-7	70.5	32	11.09	71	2.523	110	0.758
-6	66.88	33	10.63	72	2.439	111	0.737
-5	63.46	34	10.2	73	2.358	112	0.717
-4	60.23	35	9.779	74	2.28	113	0.697
-3	57.18	36	9.382	75	2.206	114	0.678
-2	54.31	37	9.003	76	2.133	115	0.66
-1	51.59	38	8.642	77	2.064	116	0.642
0	49.02	39	8.297	78	1.997	117	0.625
1	46.6	40	7.967	79	1.933	118	0.608
2	44.31	41	7.653	80	1.871	119	0.592
3	42.14	42	7.352	81	1.811	120	0.577
4	40.09	43	7.065	82	1.754	121	0.561
5	38.15	44	6.791	83	1.699	122	0.547
6	36.32	45	6.529	84	1.645	123	0.532
7	34.58	46	6.278	85	1.594	124	0.519
8	32.94	47	6.038	86	1.544	125	0.505
9	31.38	48	5.809	87	1.497	126	0.492
10	29.9	49	5.589	88	1.451	127	0.48
11	28.51	50	5.379	89	1.408	128	0.467
12	27.18	51	5.197	90	1.363	129	0.456
13	25.92	52	4.986	91	1.322	130	0.444
14	24.73	53	4.802	92	1.282	131	0.433
15	23.6	54	4.625	93	1.244	132	0.422
16	22.53	55	4.456	94	1.207	133	0.412
17	21.51	56	4.294	95	1.171	134	0.401
18	20.54	57	4.139	96	1.136	135	0.391
19	19.63	58	3.99	97	1.103	136	0.382

Resistance Table of Tube Temperature Sensors for Indoor and Outdoor (20K)

Temp(°C)	Resistance(kΩ)	Temp(°C)	Resistance(kΩ)	Temp(°C)	Resistance(kΩ)	Temp(°C)	Resistance(kΩ)
-19	181.4	20	25.01	59	5.13	98	1.427
-18	171.4	21	23.9	60	4.948	99	1.386
-17	162.1	22	22.85	61	4.773	100	1.346
-16	153.3	23	21.85	62	4.605	101	1.307
-15	145	24	20.9	63	4.443	102	1.269
-14	137.2	25	20	64	4.289	103	1.233
-13	129.9	26	19.14	65	4.14	104	1.198
-12	123	27	18.13	66	3.998	105	1.164
-11	116.5	28	17.55	67	3.861	106	1.131
-10	110.3	29	16.8	68	3.729	107	1.099
-9	104.6	30	16.1	69	3.603	108	1.069
-8	99.13	31	15.43	70	3.481	109	1.039
-7	94	32	14.79	71	3.364	110	1.01
-6	89.17	33	14.18	72	3.252	111	0.983
-5	84.61	34	13.59	73	3.144	112	0.956
-4	80.31	35	13.04	74	3.04	113	0.93
-3	76.24	36	12.51	75	2.94	114	0.904
-2	72.41	37	12	76	2.844	115	0.88
-1	68.79	38	11.52	77	2.752	116	0.856
0	65.37	39	11.06	78	2.663	117	0.833
1	62.13	40	10.62	79	2.577	118	0.811
2	59.08	41	10.2	80	2.495	119	0.77
3	56.19	42	9.803	81	2.415	120	0.769
4	53.46	43	9.42	82	2.339	121	0.746
5	50.87	44	9.054	83	2.265	122	0.729
6	48.42	45	8.705	84	2.194	123	0.71
7	46.11	46	8.37	85	2.125	124	0.692
8	43.92	47	8.051	86	2.059	125	0.674
9	41.84	48	7.745	87	1.996	126	0.658
10	39.87	49	7.453	88	1.934	127	0.64
11	38.01	50	7.173	89	1.875	128	0.623
12	36.24	51	6.905	90	1.818	129	0.607
13	34.57	52	6.648	91	1.736	130	0.592
14	32.98	53	6.403	92	1.71	131	0.577
15	31.47	54	6.167	93	1.658	132	0.563
16	30.04	55	5.942	94	1.609	133	0.549
17	28.68	56	5.726	95	1.561	134	0.535
18	27.39	57	5.519	96	1.515	135	0.521
19	26.17	58	5.32	97	1.47	136	0.509

Resistance Table of Discharge Temperature Sensor for Outdoor(50K)

Temp(°C)	Resistance(kΩ)	Temp(°C)	Resistance(kΩ)	Temp(°C)	Resistance(kΩ)	Temp(°C)	Resistance(kΩ)
-29	853.5	10	98	49	18.34	88	4.75
-28	799.8	11	93.42	50	17.65	89	4.61
-27	750	12	89.07	51	16.99	90	4.47
-26	703.8	13	84.95	52	16.36	91	4.33
-25	660.8	14	81.05	53	15.75	92	4.20
-24	620.8	15	77.35	54	15.17	93	4.08
-23	580.6	16	73.83	55	14.62	94	3.96
-22	548.9	17	70.5	56	14.09	95	3.84
-21	516.6	18	67.34	57	13.58	96	3.73
-20	486.5	19	64.33	58	13.09	97	3.62
-19	458.3	20	61.48	59	12.62	98	3.51
-18	432	21	58.77	60	12.17	99	3.41
-17	407.4	22	56.19	61	11.74	100	3.32
-16	384.5	23	53.74	62	11.32	101	3.22
-15	362.9	24	51.41	63	10.93	102	3.13
-14	342.8	25	49.19	64	10.54	103	3.04
-13	323.9	26	47.08	65	10.18	104	2.96
-12	306.2	27	45.07	66	9.83	105	2.87
-11	289.6	28	43.16	67	9.49	106	2.79
-10	274	29	41.34	68	9.17	107	2.72
-9	259.3	30	39.61	69	8.85	108	2.64
-8	245.6	31	37.96	70	8.56	109	2.57
-7	232.6	32	36.38	71	8.27	110	2.50
-6	220.5	33	34.88	72	7.99	111	2.43
-5	209	34	33.45	73	7.73	112	2.37
-4	198.3	35	32.09	74	7.47	113	2.30
-3	199.1	36	30.79	75	7.22	114	2.24
-2	178.5	37	29.54	76	7.00	115	2.18
-1	169.5	38	28.36	77	6.76	116	2.12
0	161	39	27.23	78	6.54	117	2.07
1	153	40	26.15	79	6.33	118	2.02
2	145.4	41	25.11	80	6.13	119	1.96
3	138.3	42	24.13	81	5.93	120	1.91
4	131.5	43	23.19	82	5.75	121	1.86
5	125.1	44	22.29	83	5.57	122	1.82
6	119.1	45	21.43	84	5.39	123	1.77
7	113.4	46	20.6	85	5.22	124	1.73
8	108	47	19.81	86	5.06	125	1.68
9	102.8	48	19.06	87	4.90	126	1.64



JF00303268



GREE ELECTRIC APPLIANCES, INC. OF ZHUHAI

Add: West Jinji Rd, Qianshan, Zhuhai, Guangdong, China, 519070

Tel: (+86-756) 8522218

Fax: (+86-756) 8669426

E-mail: global@cn.gree.com www.gree.com

For product improvement, specifications and appearance in this manual are subject to change without prior notice.