

INDOOR UNIT

No. OBH930

SERVICE MANUAL

Models

MSZ-AY25VGK - E6
MSZ-AY35VGK - E6
MSZ-AY42VGK - E6
MSZ-AY50VGK - E6

MSZ-AY25VGKP - E6
MSZ-AY35VGKP - E6
MSZ-AY42VGKP - E6
MSZ-AY50VGKP - E6

Outdoor unit service manual
MUZ-AY-VG/VGH Series (OBH931)
MXZ-F-VF/VFH Series (OBH790)



CONTENTS

1. TECHNICAL CHANGES	3
2. PART NAMES AND FUNCTIONS	4
3. SPECIFICATION	5
4. NOISE CRITERIA CURVES	6
5. OUTLINES AND DIMENSIONS	7
6. WIRING DIAGRAM	8
7. REFRIGERANT SYSTEM DIAGRAM	10
8. SERVICE FUNCTIONS	11
9. MICROPROCESSOR CONTROL	17
10. TROUBLESHOOTING	25
11. DISASSEMBLY INSTRUCTIONS	41

PARTS CATALOG (OBB930)

Use the specified refrigerant only

Never use any refrigerant other than that specified.

Doing so may cause a burst, an explosion, or fire when the unit is being used, serviced, or disposed of.

Correct refrigerant is specified in the manuals and on the spec labels provided with our products.

We will not be held responsible for mechanical failure, system malfunction, unit breakdown or accidents caused by failure to follow the instructions.

<Preparation before the repair service>

- Prepare the proper tools.
- Prepare the proper protectors.
- Provide adequate ventilation.
- After stopping the operation of the air conditioner, turn off the power-supply breaker and pull the power plug.
- Discharge the capacitor before the work involving the electric parts.

<Precautions during the repair service>

- Do not perform the work involving the electric parts with wet hands.
- Do not pour water into the electric parts.
- Do not touch the refrigerant.
- Do not touch the hot or cold areas in the refrigeration cycle.
- When the repair or the inspection of the circuit needs to be done without turning off the power, exercise great caution not to touch the live parts.

WARNING

- **When the refrigeration circuit has a leak, do not execute pump down with the compressor.**
- **When pumping down the refrigerant, stop the compressor before disconnecting the refrigerant pipes. The compressor may burst if air etc. get into it.**
- **When opening or closing the valve below freezing temperatures, refrigerant may spurt out from the gap between the valve stem and the valve body, resulting in injuries.**

1

TECHNICAL CHANGES

These models are compatible with the outdoor units with low standby power control.

Connecting these models to the **MUZ-AY-VG/VGH** series outdoor units enables the low standby power control.

These models may be connected to the **MUZ-AY-VG/VGH** series after once connected to the **MXZ** series and operated, for example because of relocation. In that case, the **MUZ-AY-VG/VGH** series outdoor units will not operate without taking a step. Follow the procedure "Deleting the memorized abnormal condition" described in 10-2.1.

MSZ-AY25VGK - E6

MSZ-AY35VGK - E6

MSZ-AY42VGK - E6

MSZ-AY50VGK - E6

MSZ-AY25VGKP - E6

MSZ-AY35VGKP - E6

MSZ-AY42VGKP - E6

MSZ-AY50VGKP - E6

1. New model

2

PART NAMES AND FUNCTIONS

MSZ-AY25VGK MSZ-AY35VGK MSZ-AY42VGK MSZ-AY50VGK
 MSZ-AY25VGKP MSZ-AY35VGKP MSZ-AY42VGKP MSZ-AY50VGKP

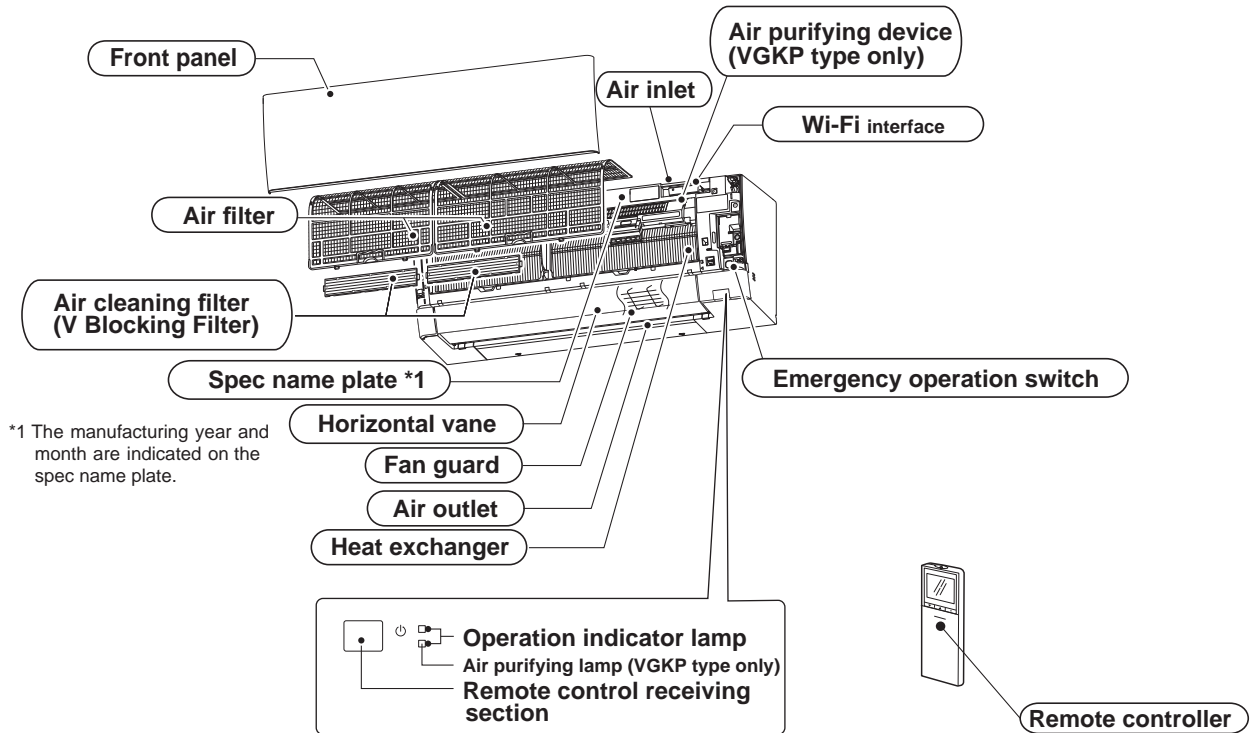

ACCESSORIES

	Model	MSZ-AY25VGK	MSZ-AY35VGK	MSZ-AY42VGK	MSZ-AY50VGK
		MSZ-AY25VGKP	MSZ-AY35VGKP	MSZ-AY42VGKP	MSZ-AY50VGKP
(1)	Installation plate			1	
(2)	Installation plate fixing screw 4 × 25 mm			5	
(3)	Wireless remote controller			1	
(4)	Felt tape (For left or left-rear piping)			1	
(5)	Battery (AAA) for remote controller			2	
(6)	Air cleaning filter			2 (VGK only)	

3

SPECIFICATION

Indoor model				MSZ-AY25VGK MSZ-AY25VGKP	MSZ-AY35VGK MSZ-AY35VGKP	MSZ-AY42VGK MSZ-AY42VGKP	MSZ-AY50VGK MSZ-AY50VGKP		
Power supply				Single phase 230 V, 50 Hz					
Electrical data	Power input *1	Cooling	W	19			24		
		Heating		26			32		
	Running current *1	Cooling	A	0.18			0.24		
		Heating		0.26			0.32		
Fan motor	Model			RC0J30CV					
	Current *1	Cooling	A	0.18			0.24		
		Heating		0.26			0.32		
Dimensions W × H × D			mm	798 × 299 × 245					
Weight			kg	VGK: 10.5 VGKP: 11					
Special remarks	Air direction			5					
	Airflow	Cooling	Super High	m³/h	630	666	630	702	
			High		468		504	546	
			Med.		378		420	450	
			Low		300		342	384	
			Silent		216		270	312	
		Heating	Super High	m³/h	708		774		
			High		480		516	546	
			Med.		396		420	438	
			Low		300		318	342	
			Silent		240		264	288	
	Sound level	Cooling	Super High	dB(A)	42			44	
			High		36		38	40	
			Med.		30		34	36	
			Low		24		29	33	
			Silent		18		21	28	
		Heating	Super High	dB(A)	45			48	
			High		39		38	43	
			Med.		34		31	38	
			Low		24		29	33	
			Silent		18		21	28	
	Fan speed	Cooling	Super High	rpm	940	980	940	1,020	
			High		760		800	850	
			Med.		650		700	740	
Low			560			610	660		
Silent			450			520	570		
Heating		Super High	rpm	1,030		1,100			
		High		770		810	850		
		Med.		670		700	720		
		Low		560		580	610		
		Silent		480		510	540		
Fan speed regulator				5					
Remote controller model				VGK: SH22Q VGKP: SH22R					

NOTE: Test conditions are based on ISO 5151.

Cooling: Indoor Dry-bulb temperature 27°C Wet-bulb temperature 19°C
 Outdoor Dry-bulb temperature 35°C Wet-bulb temperature 24°C
 Heating: Indoor Dry-bulb temperature 20°C Wet-bulb temperature 15°C
 Outdoor Dry-bulb temperature 7°C Wet-bulb temperature 6°C

*1 Measured under rated operating frequency.

Specifications and rated conditions of main electric parts

Fuse	(F11)	T3.15AL250V
Horizontal vane motor	(MV1, MV2)	12 V DC
Vertical Vane motor	(MV3)	12 V DC
Varistor	(NR11)	470 V
Terminal block	(TB)	3P

**MSZ-AY25VGK
MSZ-AY25VGKP**

FAN SPEED	FUNCTION	SPL(dB(A))	LINE
Super High	COOLING	42	●—●
	HEATING	45	○—○

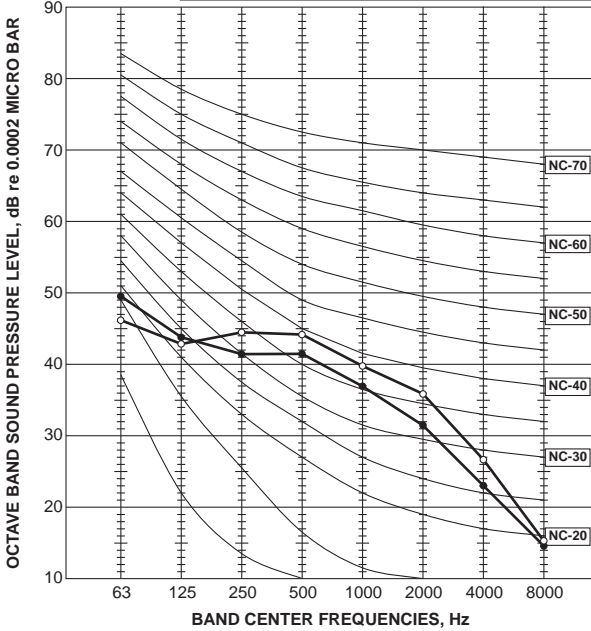

**MSZ-AY35VGK
MSZ-AY35VGKP**

FAN SPEED	FUNCTION	SPL(dB(A))	LINE
Super High	COOLING	42	●—●
	HEATING	45	○—○

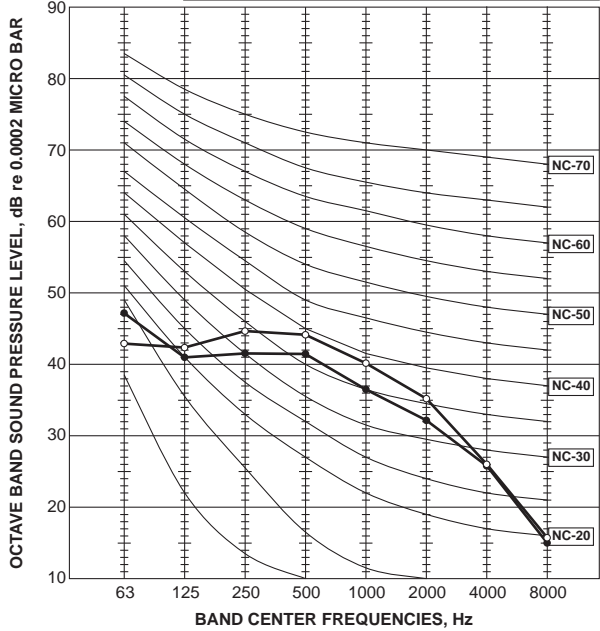

**MSZ-AY42VGK
MSZ-AY42VGKP**

FAN SPEED	FUNCTION	SPL(dB(A))	LINE
Super High	COOLING	42	●—●
	HEATING	45	○—○

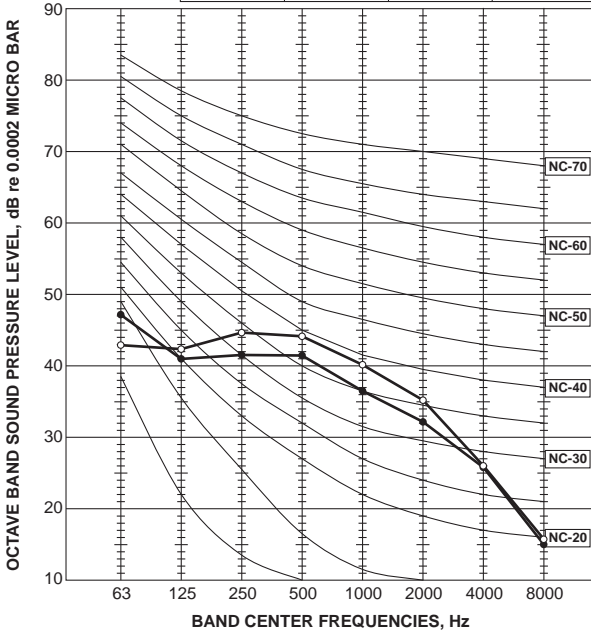

**MSZ-AY50VGK
MSZ-AY50VGKP**

FAN SPEED	FUNCTION	SPL(dB(A))	LINE
Super High	COOLING	44	●—●
	HEATING	48	○—○

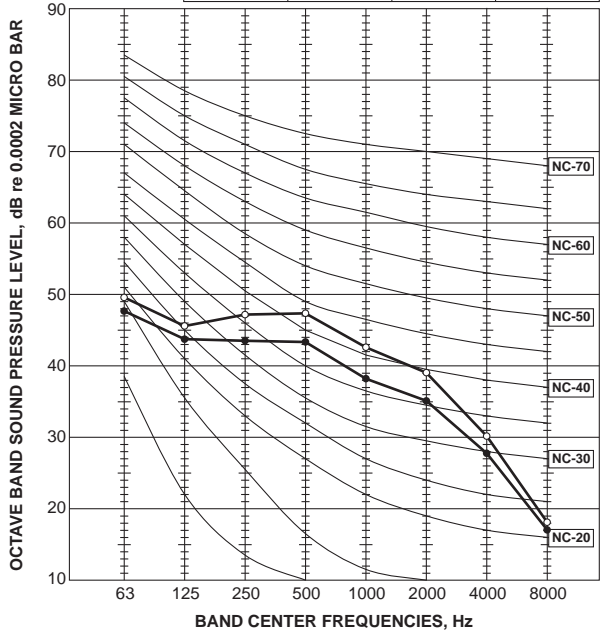

Test conditions

- Cooling: Dry-bulb temperature 27°C
Wet-bulb temperature 19°C
- Heating: Dry-bulb temperature 20°C

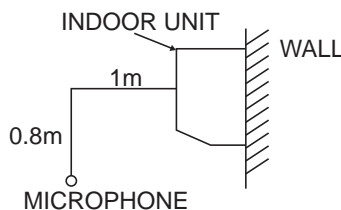

5

OUTLINES AND DIMENSIONS

MSZ-AY25VGK MSZ-AY35VGK MSZ-AY42VGK MSZ-AY50VGK
MSZ-AY25VGKP MSZ-AY35VGKP MSZ-AY42VGKP MSZ-AY50VGKP

Unit: mm

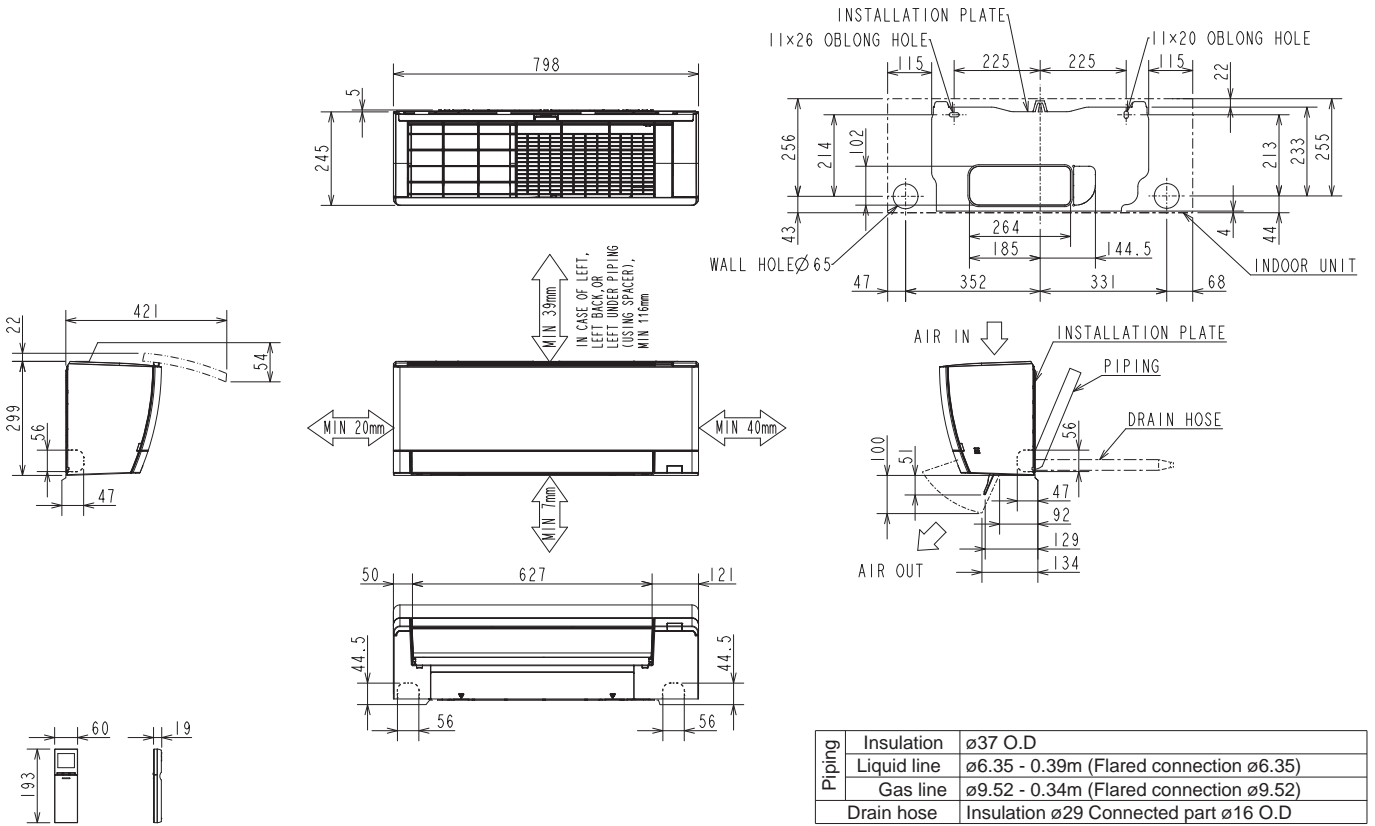

Piping	Insulation	ø37 O.D
	Liquid line	ø6.35 - 0.39m (Flared connection ø6.35)
	Gas line	ø9.52 - 0.34m (Flared connection ø9.52)
Drain hose	Insulation ø29	Connected part ø16 O.D

MSZ-AY25VGK MSZ-AY35VGK MSZ-AY42VGK

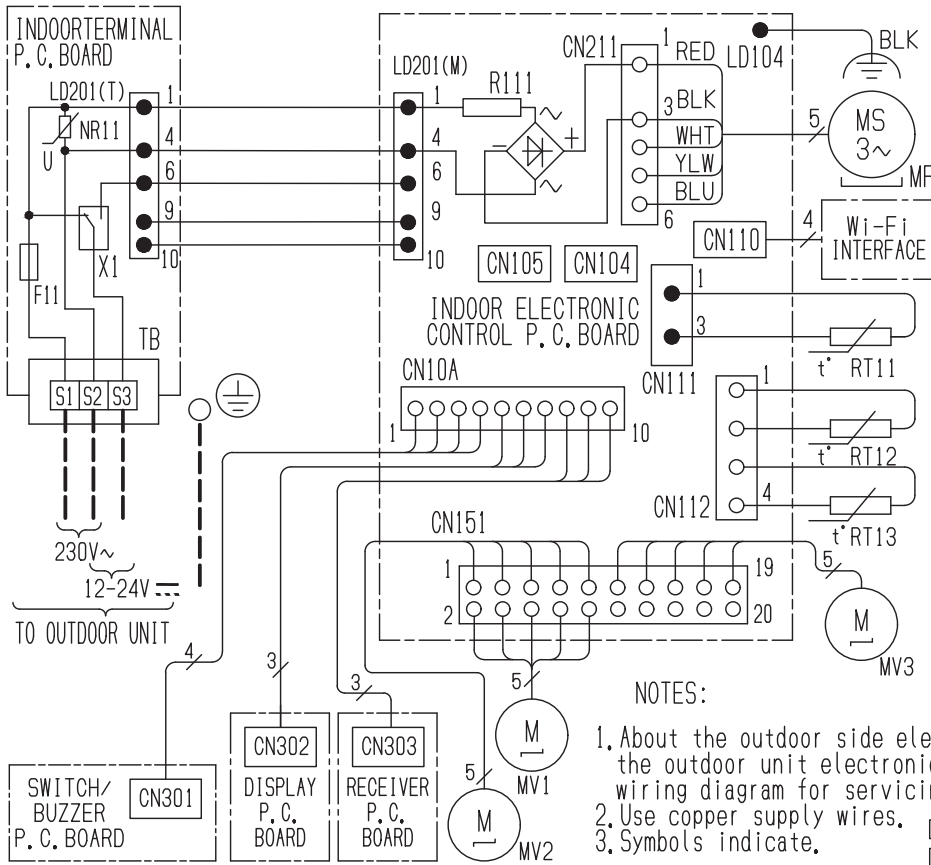

SYMBOL	NAME
F11	FUSE (T3, 15A/250V)
MF	FAN MOTOR
MV1	VANE MOTOR (HORIZONTAL UPPER)
MV2	VANE MOTOR (HORIZONTAL LOWER)
MV3	VANE MOTOR (VERTICAL)
NR11	VARISTOR
R111	RESISTOR
RT11	ROOM TEMP. THERMISTOR
RT12	COIL TEMP. THERMISTOR (MAIN)
RT13	COIL TEMP. THERMISTOR (SUB)
TB	TERMINAL BLOCK
X1	RELAY

NOTES:

- About the outdoor side electronic wiring refer to the outdoor unit electronic wiring diagram for servicing.
- Use copper supply wires.
- Symbols indicate.

□ □ □ □ : Terminal block
 ○ ○ ○ ○ : Connector

MSZ-AY50VGK

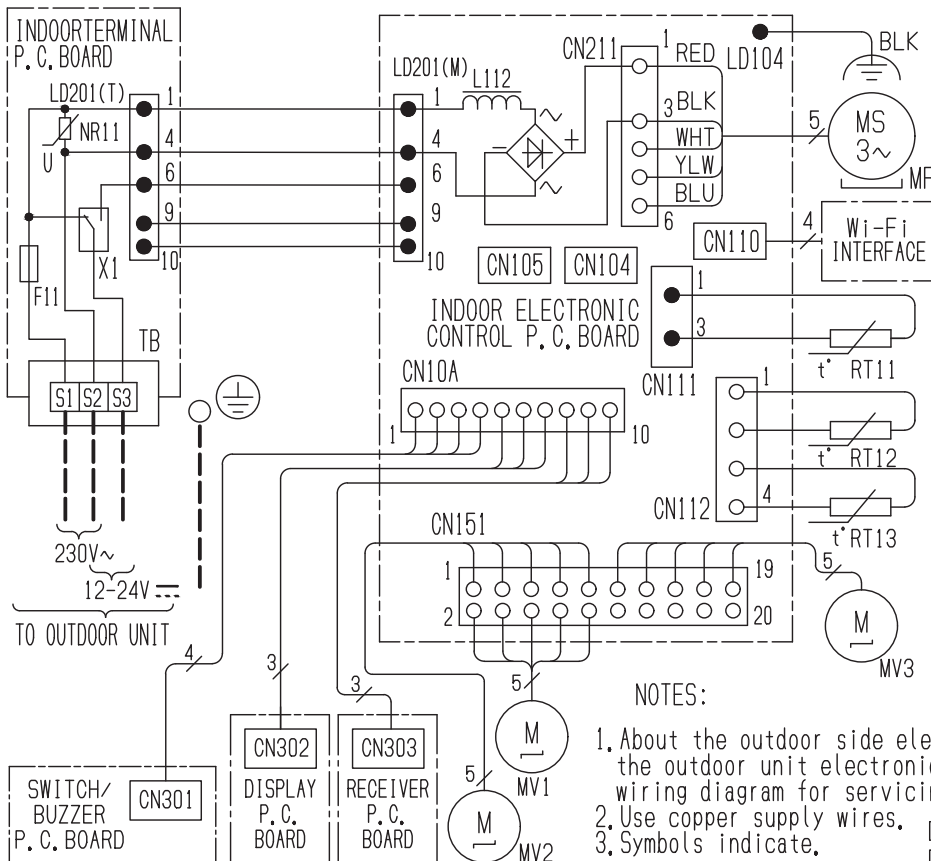

SYMBOL	NAME
F11	FUSE (T3, 15A/250V)
MF	FAN MOTOR
MV1	VANE MOTOR (HORIZONTAL UPPER)
MV2	VANE MOTOR (HORIZONTAL LOWER)
MV3	VANE MOTOR (VERTICAL)
NR11	VARISTOR
L112	REACTOR
RT11	ROOM TEMP. THERMISTOR
RT12	COIL TEMP. THERMISTOR (MAIN)
RT13	COIL TEMP. THERMISTOR (SUB)
TB	TERMINAL BLOCK
X1	RELAY

NOTES:

- About the outdoor side electronic wiring refer to the outdoor unit electronic wiring diagram for servicing.
- Use copper supply wires.
- Symbols indicate.

□ □ □ □ : Terminal block
 ○ ○ ○ ○ : Connector

MSZ-AY25VGKP MSZ-AY35VGKP MSZ-AY42VGKP

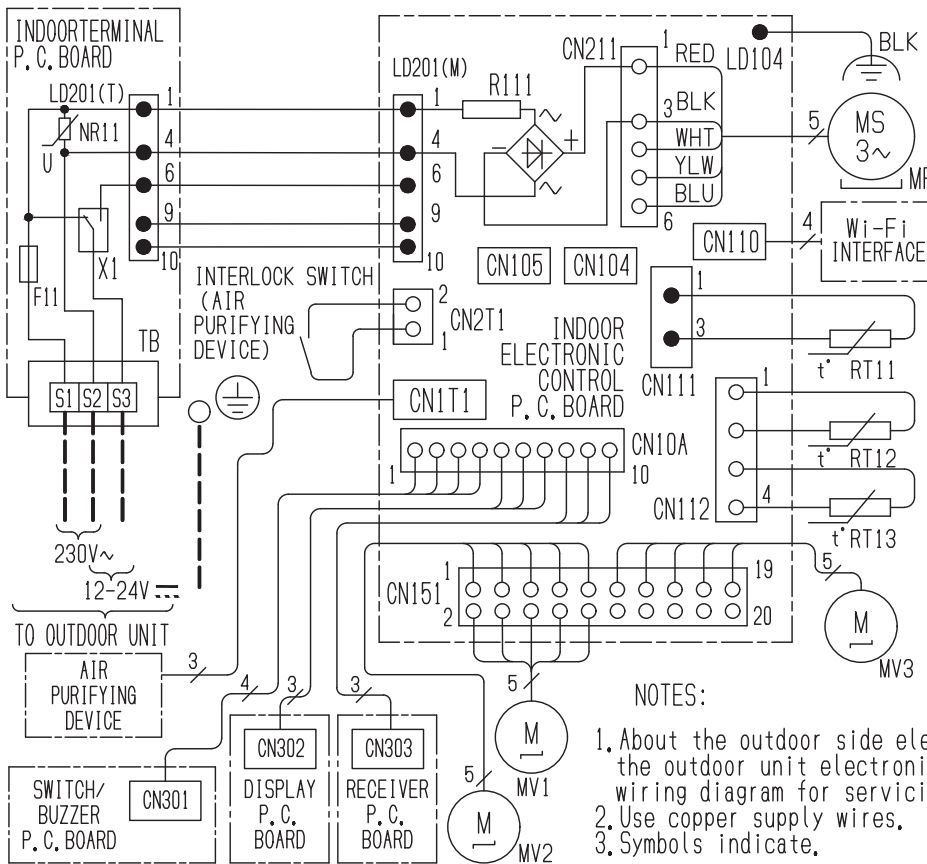

SYMBOL	NAME
F11	FUSE (T3, 15AL250V)
MF	FAN MOTOR
MV1	VANE MOTOR (HORIZONTAL UPPER)
MV2	VANE MOTOR (HORIZONTAL LOWER)
MV3	VANE MOTOR (VERTICAL)
NR11	VARISTOR
R111	RESISTOR
RT11	ROOM TEMP. THERMISTOR
RT12	COIL TEMP. THERMISTOR (MAIN)
RT13	COIL TEMP. THERMISTOR (SUB)
TB	TERMINAL BLOCK
X1	RELAY

NOTES:

- About the outdoor side electronic wiring refer to the outdoor unit electronic wiring diagram for servicing.
- Use copper supply wires.
- Symbols indicate.

	: Terminal block
	: Connector

MSZ-AY50VGKP

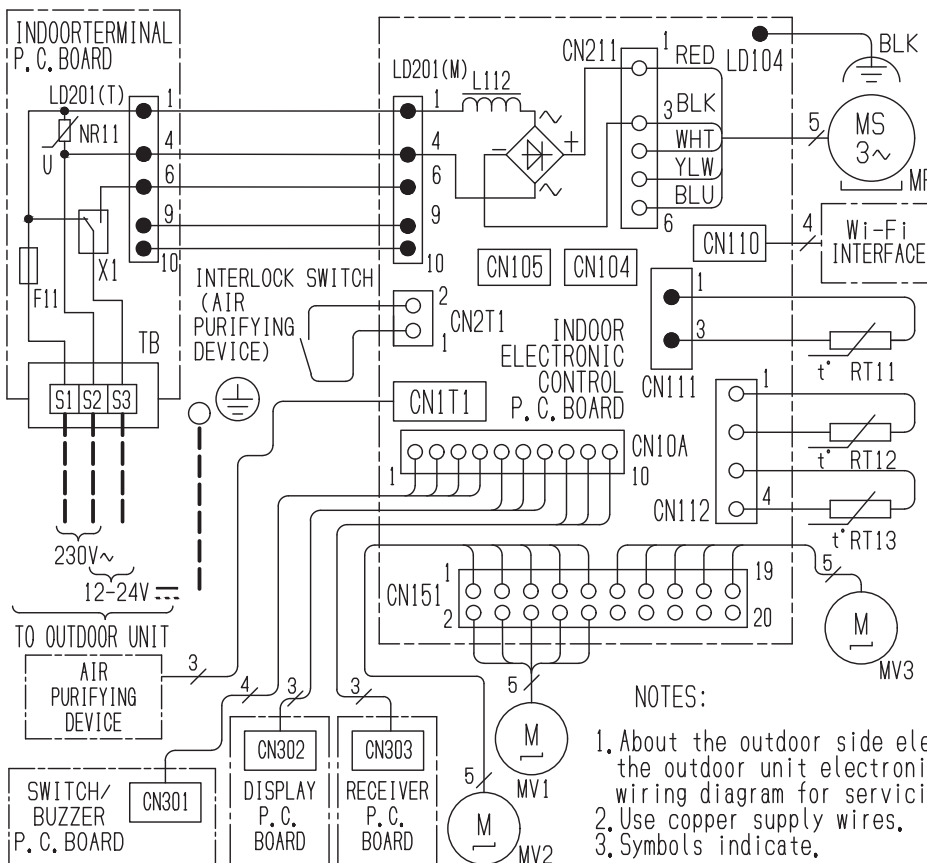

SYMBOL	NAME
F11	FUSE (T3, 15AL250V)
MF	FAN MOTOR
MV1	VANE MOTOR (HORIZONTAL UPPER)
MV2	VANE MOTOR (HORIZONTAL LOWER)
MV3	VANE MOTOR (VERTICAL)
NR11	VARISTOR
L112	REACTOR
RT11	ROOM TEMP. THERMISTOR
RT12	COIL TEMP. THERMISTOR (MAIN)
RT13	COIL TEMP. THERMISTOR (SUB)
TB	TERMINAL BLOCK
X1	RELAY

NOTES:

- About the outdoor side electronic wiring refer to the outdoor unit electronic wiring diagram for servicing.
- Use copper supply wires.
- Symbols indicate.

	: Terminal block
	: Connector

MSZ-AY25VGK MSZ-AY35VGK
MSZ-AY25VGKP MSZ-AY35VGKP

Unit: mm

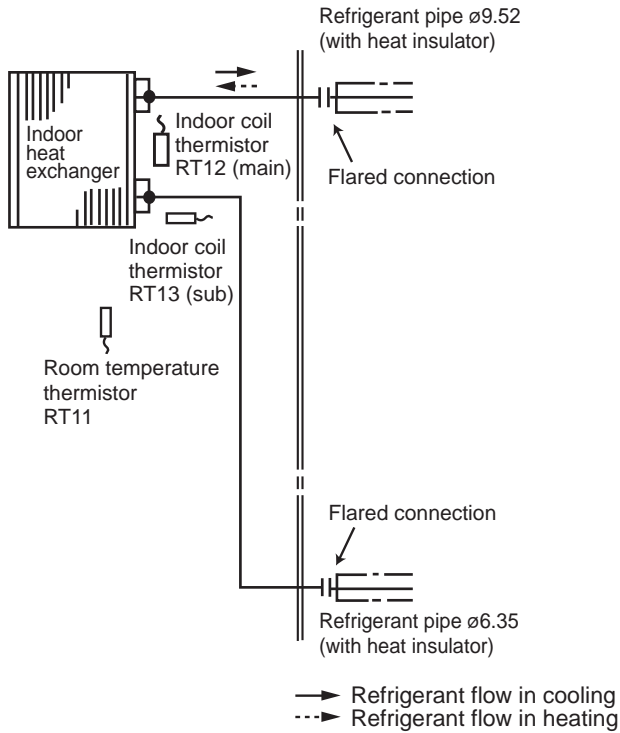

MSZ-AY42VGK MSZ-AY50VGK
MSZ-AY42VGKP MSZ-AY50VGKP

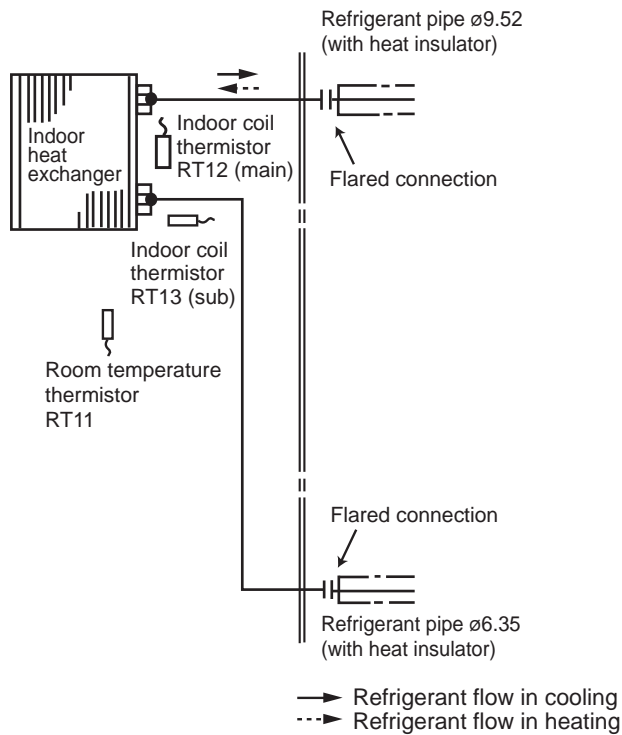

MSZ-AY25VGK MSZ-AY35VGK MSZ-AY42VGK MSZ-AY50VGK MSZ-AY25VGKP MSZ-AY35VGKP MSZ-AY42VGKP MSZ-AY50VGKP

8-1. TIMER SHORT MODE

For service, the following set time can be shortened by bridging the timer short mode point on the electronic control P.C. board.

(Refer to 10-7.)

- The set time for the ON/OFF timer can be reduced to 1 second for each minute.
- After the breaker is turned on, the time for starting the compressor, which normally takes 3 minutes, can be reduced to 1 minute. Restarting the compressor, which takes 3 minutes, cannot be reduced.

8-2. HOW TO SET REMOTE CONTROLLER EXCLUSIVELY FOR A PARTICULAR INDOOR UNIT

A maximum of 4 indoor units with wireless remote controllers can be used in a room.

To operate the indoor units individually with each remote controller, assign a number to each remote controller according to the number of the indoor unit.

This setting can be set only when all the following conditions are met:

- The remote controller is powered OFF.
- Weekly timer is not set.
- Weekly timer is not being edited.

(1) Hold down $\boxed{1\sim4}$ button on the remote controller for 2 seconds to enter the pairing mode.

(2) Press $\boxed{1\sim4}$ button again and assign a number to each remote controller.

Each press of $\boxed{1\sim4}$ button advances the number in the following order: 1 → 2 → 3 → 4.

(3) Press $\boxed{\text{EDIT/SEND SET}}$ button to complete the pairing setting.

After you turn the breaker ON, the remote controller that first sends a signal to an indoor unit will be regarded as the remote controller for the indoor unit.

Once they are set, the indoor unit will only receive the signal from the assigned remote controller afterwards.

8-3. AUTO RESTART FUNCTION

When the indoor unit is controlled with the remote controller, the operation mode, the set temperature, and the fan speed are memorized by the indoor electronic control P.C. board. "AUTO RESTART FUNCTION" automatically starts operation in the same mode just before the shutoff of the main power.

Operation

- ① If the main power has been cut, the operation settings remain.
- ② After the power is restored, the unit restarts automatically according to the memory.
(However, it takes at least 3 minutes for the compressor to start running.)

How to disable "AUTO RESTART FUNCTION"

- ① Turn off the main power for the unit.
- ② Cut the jumper wire to JR77 on the indoor electronic control P.C. board.
(Refer to 10-7.)

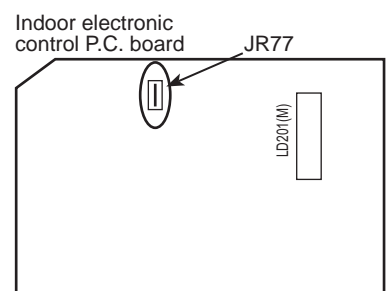

NOTE:

- The operation settings are memorized when 10 seconds have passed after the indoor unit was operated with the remote controller.
- If main power is turned OFF or a power failure occurs while AUTO START/STOP timer is active, the timer setting is cancelled.
- If the unit has been off with the remote controller before power failure, the auto restart function does not work as the power button of the remote controller is OFF.
- To prevent breaker OFF due to the rush of starting current, systematize other home appliance not to turn ON at the same time.
- When some air conditioners are connected to the same supply system, if they are operated before power failure, the starting current of all the compressors may flow simultaneously at restart.
Therefore, the special counter-measures are required to prevent the main voltage-drop or the rush of the starting current by adding to the system that allows the units to start one by one.

8-4. Wi-Fi INTERFACE SETTING UP

This Wi-Fi interface, communicates the status information and controls the commands from the MELCloud by connecting to the indoor unit.

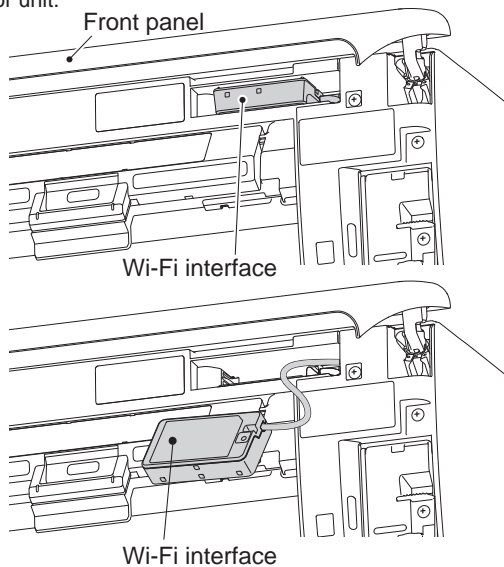

1. Wi-Fi interface introduction

NET LED
It shows the network state.
(Refer to 8-4.3-3. **NET LED**.)

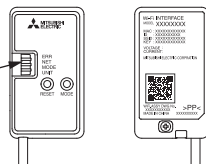

2. Setting up

Set up a connection between the Wi-Fi interface and the router.

NOTE:

Setup is possible only after operating the air conditioner using the wireless remote controller.

For MELCloud User Manual, please go to the website below.

www.melcloud.com/Support

3. Selecting a mode

The Wi-Fi interface has to be paired with the router in order for communication between the indoor unit and MELCloud to begin. There are 2 methods of pairing the Wi-Fi interface with the router:

- WPS-PUSH mode
- Access Point mode

The mode to be set depends on whether your router has the WPS button.

Use the pairing mode most suitable for your system.

Follow the instructions below to set the pairing mode with Remote controller.

Set up the Wi-Fi interface and the router again when the router has been replaced.

To reset connection and set up the Wi-Fi interface and the router again

- (1) Hold down the Temperature \ominus for 5 seconds.
- (2) Select “_2” by pressing Temperature \oplus and \ominus .
- (3) Point the remote controller toward the indoor unit and press the OFF/ON button.
- (4) The indoor unit beeps 3 times when resetting is complete.

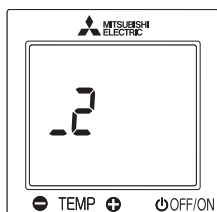

3-1. Setting up in WPS-PUSH mode

To enter the mode

- (1) Hold down the Temperature \oplus for 5 seconds.
- (2) Select “_2” by pressing Temperature \oplus and \ominus as shown on the right.
- (3) Point the remote controller toward the indoor unit and press the OFF/ON button.

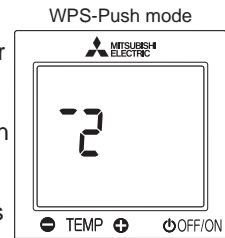

3-1.1. Connect the router to the air conditioner.

Make sure that the LED indication is as shown below.

Push WPS button of the router within 2 minutes after the mode selection has completed.

The WPS-PUSH mode will return to initial state if WPS button is not pressed for 2 minutes.

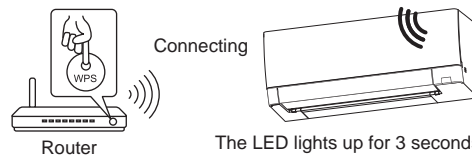

The LED lights up for 3 seconds then blinks twice.
A beep sounds as the LED blinks.
This series of actions is repeated.

3-1.2. LED will be as shown below when connection between the router and Wi-Fi interface is completed and connection to MELCloud starts.

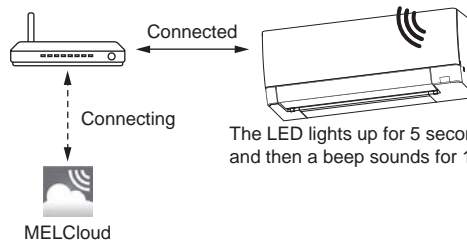

The LED lights up for 5 seconds and then a beep sounds for 1 second.

NOTE:

If the indication LED does not change or blinks 5 times, connection fails. Please reset connection and setup the Wi-Fi interface and the router again.

Main causes that Wi-Fi failed are as follows.

Communication distance (from the Wi-Fi interface to router), router settings (encryption, authentication, limit of connections, etc.)

3-2. Setting up in Access Point mode

Complete the setting up in the Access Point mode within 10 minutes.

To enter the mode

- (1) Hold down the Temperature \oplus for 5 seconds.
- (2) Select "1" by pressing Temperature \oplus and \ominus as shown on the right.
- (3) Point the remote controller toward the indoor unit and press the OFF/ON \square .

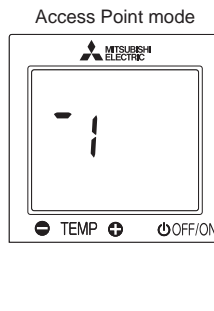

3-2.1. Connect your smartphone to the air conditioner.

Make sure that the LED indication is as shown below. On the Wi-Fi Setting Screen on your smartphone, select SSID and enter KEY, which are printed on the information label.

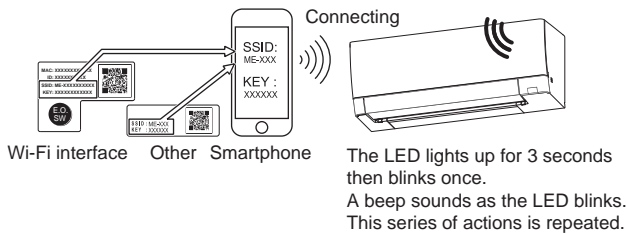

NOTE:

- Check Wi-Fi setting of your smartphone if SSID does not appear on it.
- Enter KEY again if SSID appears on your smartphone, but it cannot connect to the Wi-Fi interface.
- The LED indication does not change or blinks 5 times if connection fails. In that case, reset connection and set up the Wi-Fi interface and the router again.

3-2.2. Access URL (<http://192.168.11.1/network>) by any of the following methods to display the setting screen.

- (1) Scan the matrix barcode below.
- (2) Scan the matrix barcode on the information label.
- (3) Type the URL (<http://192.168.11.1/network>) in the web browser.

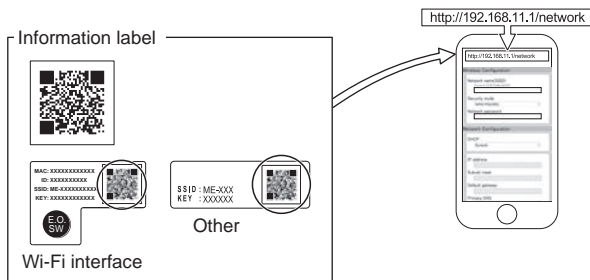

3-2.3. Register the information of the router on the air conditioner.

In the displayed window, select Dynamic in DHCP (*1) and enter the information of router, then tap the Submit button.

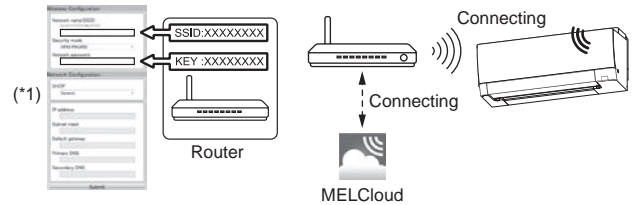

NOTE:

- If you want to use Static, select Static in DHCP (*1) and enter the information of router and network, then tap the Submit button.

3-2.4. LED indication will be as shown below when connection between the router and Wi-Fi interface is completed and connection to MELCloud starts.

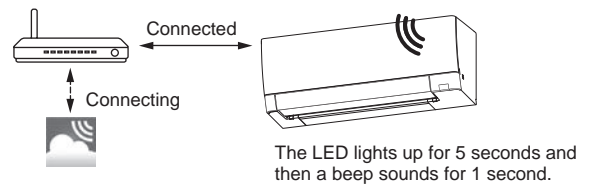

NOTE:

It may take several minutes to show the indication above. The LED indication does not change or blinks 5 times if connection fails. In that case, reset connection and set up the Wi-Fi interface and the router again.

3-3. NET LED

NET LED blinking indicates that the Wi-Fi interface is communicating with the router.

3-4. When it doesn't connect well

Check the following, and pair the Wi-Fi interface and the router according to Selecting a mode.

- Make sure that the communication distance is not too far between the Wi-Fi interface and the router.
- Make sure that the router uses WPA2-AES encryption.
- Make sure that the number of connected devices to the router does not exceed the limit.
- Make sure that DHCP is enabled, or check IP address setting of the Wi-Fi interface.
- Check DNS settings of the router, or check DNS address of the Wi-Fi interface.
- Check if the router is connected to Internet.
- Set up the Wi-Fi interface after operating the air conditioner using the wirelessremote controller at least once.

If the connection fails even after checking the above, set up the Wi-Fi interface and the router again by the following method.

- Hold down the Temperature \ominus for 5 seconds.
- Select “_ 2” by pressing Temperature \oplus and \ominus .
- Point the remote controller toward the indoor unit and press the  .
- The indoor unit beeps 3 times when resetting is complete.

[About trademarks]

- WPS is the connection via Wi-Fi Protected Setup.
- “Wi-Fi®”, “Wi-Fi Protected Setup™”, “WPA2™” are trademarks or registered trademarks of the Wi-Fi Alliance.

For Declaration of Conformity and MELCloud User Manual, please go to the website below.
www.melcloud.com/Support
After accessing the address above, select “United Kingdom” to view support details.

The Wi-Fi interface uses Open Source Software. To view the Open Source software licence(s), please go to the following website whilst connected to the Wi-Fi interface during the Access Point mode.
<http://192.168.11.1/license>

NOTE:

- Ensure that the router supports the WPA2-AES encryption setting before starting the Wi-Fi interface setup.
- The End user should read and accept the terms and conditions of the Wi-Fi service before using this Wi-Fi interface.
- To complete connection of this Wi-Fi interface to the Wi-Fi service, the router may be required.
- This Wi-Fi interface will not commence transmission of any operational data from the system until the End user registers and accepts the terms and conditions of the Wi-Fi service.
- This Wi-Fi interface should not be installed and connected to any Mitsubishi Electric system which is to provide application critical cooling or heating.
- At the time of relocation or disposal, reset the Wi-Fi interface to the factory default.

For the latest information regarding MELCloud from Mitsubishi Electric Corporation, please visit <https://www.melcloud.com>.

8-5. CHANGING THE CORRECTION VALUE OF THE ROOM TEMPERATURE (THE INLET TEMPERATURE)

The correction value of the room temperature can be adjusted in the range of 2 to 5 °C with the remote controller.

Normally, the temperature at the room temperature sensor might become higher than that around feet because warm air tends to accumulate around an indoor unit during heating operation. Thus, if you correct the room temperature to the temperature about 2 °C lower than that detected by the room temperature sensor, the air conditioner capacity during heating operation increases, which suppresses a decrease in the temperature around feet.

The optimal correction values of the room temperature, however, might differ depending on the installation environments such as installation height of the indoor unit or the ceiling height, so adjust the correction value of the room temperature in the range of 2 to 5 °C with the remote controller.

NOTE 1: The room will be warmer if you set the correction value of the room temperature to 5°C.

1. How to change the correction value of the room temperature

(1) Press [① OFF/ON] button on the remote controller to turn the indoor unit off. (Figure 1)

(2) Point the remote controller at the indoor unit.

While you hold down [② MODE] and [③ TEMP \ominus] at the same time, press [④ RESET], and keep holding [② MODE] and [③ TEMP \ominus] to indicate the correction value of the room temperature that was set the last time with the remote controller (Figure 2 shows 2°C at factory setting).

NOTE 2: Point the remote controller at the indoor unit while working in the procedure (3) and (4) like the procedure (2).

(3) Press [③ TEMP \ominus] or [⑤ TEMP \oplus] to change the correction value of the room temperature.

(4) Set the correction value of the room temperature to the desired value, and then press [① OFF/ON] button on the remote controller to turn the indoor unit off. (Figure 1)

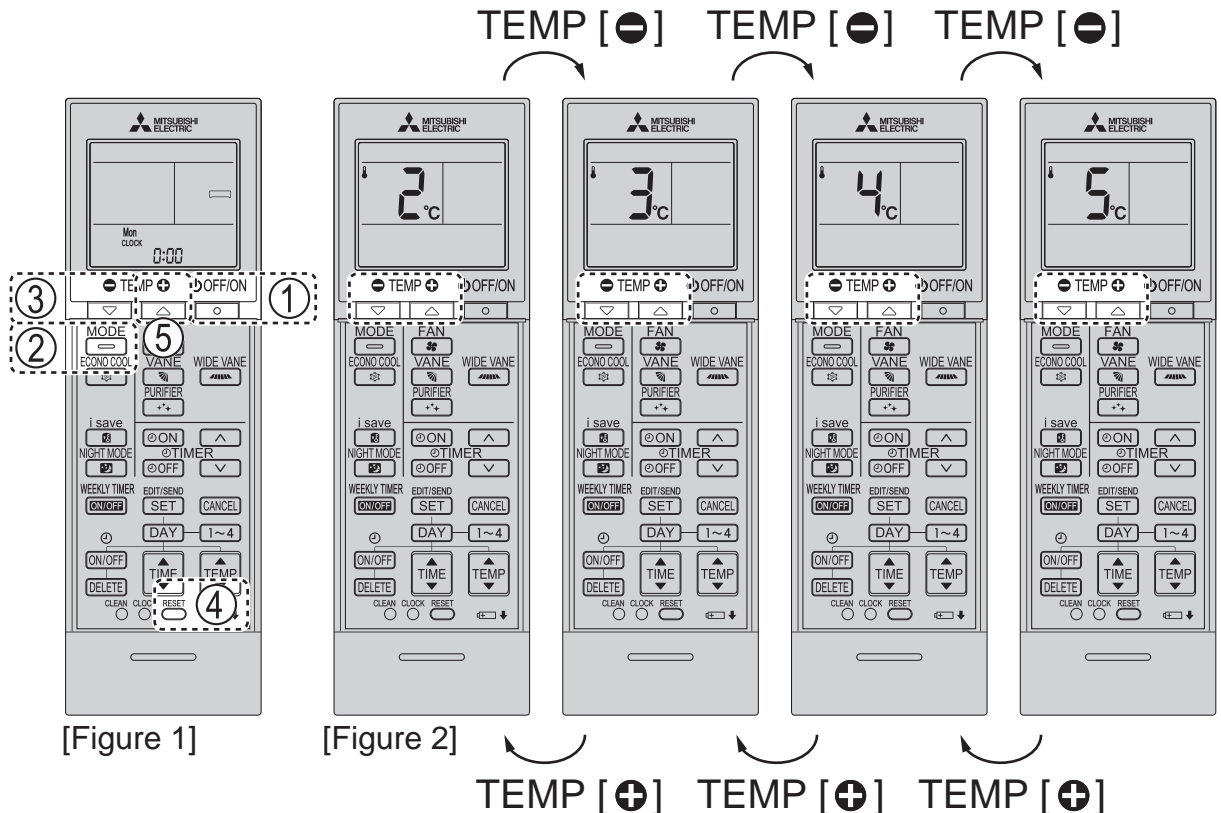

2. Writing the correction value of the room temperature on the wiring diagram

After setting the correction value of the room temperature (the inlet air temperature), follow 11. DISASSEMBLY INSTRUCTIONS to disassemble the indoor unit, and then write the correction value (any of 3, 4, or 5) on the wiring diagram with a ballpoint pen, etc. (e.g. The numerical value is described in the bold square.) (Figure 3)

If the indoor electronic control P.C. board is replaced in servicing, the correction value is reset. The numerical value (any of 3, 4, or 5) described on the wiring diagram will be needed when a service man sets the correction value again after replacing the P.C. board.

NOTE 3: The instruction for setting the correction value again is attached to the indoor electronic control P.C. board of the service part as well.

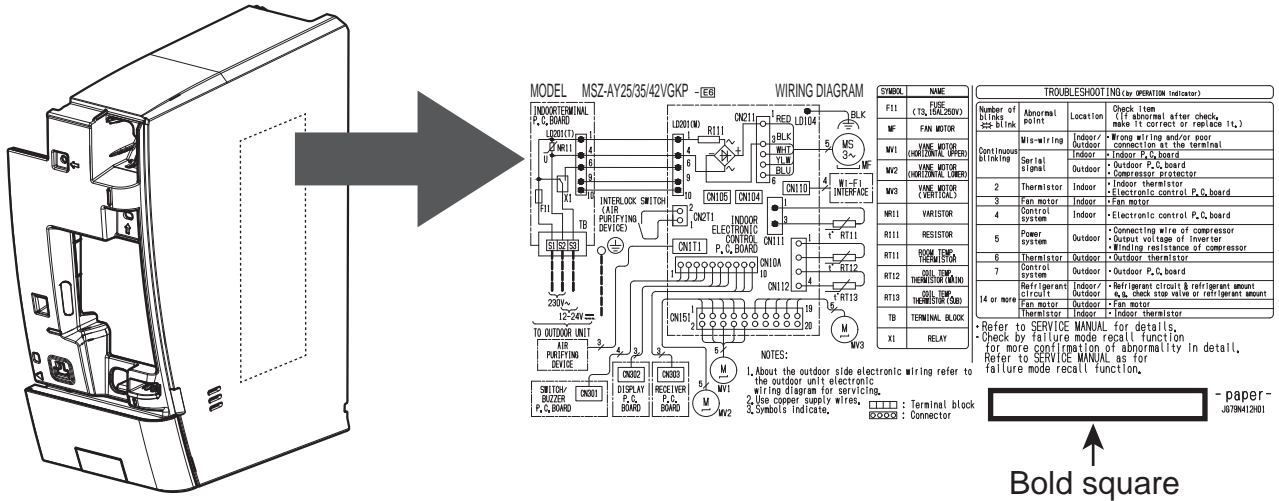

[Figure 3]

If you cut the jumper wire JR24 (Refer to 10-7.), a correction value of the room temperature during heating operation turns to 0°C regardless of the correction commands from the remote controller. (Figure 4)

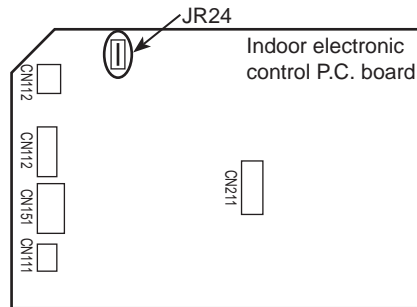

[Figure 4]

MSZ-AY25VGK MSZ-AY35VGK MSZ-AY42VGK MSZ-AY50VGK
MSZ-AY25VGKP MSZ-AY35VGKP MSZ-AY42VGKP MSZ-AY50VGKP

WIRELESS REMOTE CONTROLLER

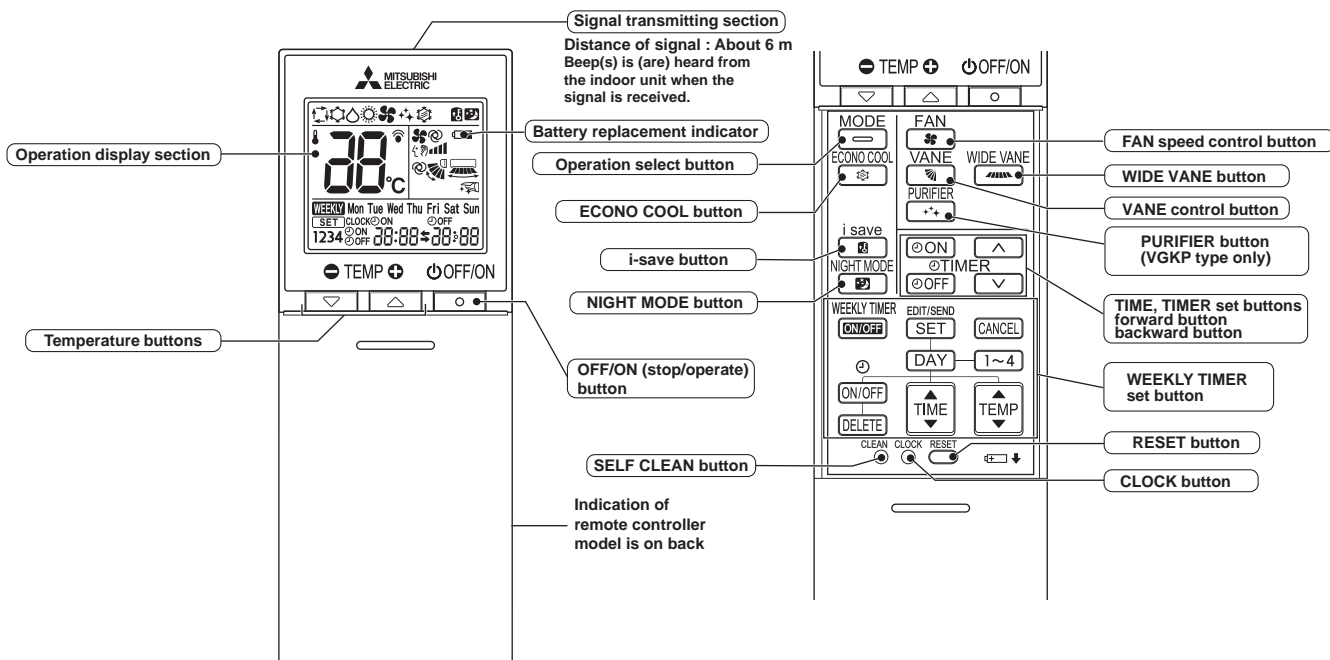









NOTE: Last setting will be stored after the unit is turned OFF with the remote controller. Indoor unit receives the signal of the remote controller with beeps.

INDOOR UNIT DISPLAY SECTION

Operation Indicator lamp

The operation indicator at the right side of the indoor unit indicates the operation state.

- The following indication applies regardless of shape of the indication.

Indication	Operation state	Room temperature
 	The unit is operating to reach the set temperature (VGK only)	About 2°C or more away from set temperature
 	The room temperature is approaching the set temperature (VGK only)	About 1 to 2°C from set temperature
 	Lower lamp lights during clean operation. Refer to 9-13.	—
 	Standby mode (Only during multi system operation)	—

 Lit
 Blinking
 Not lit

9-1. COOL (☼) OPERATION

- Press OFF/ON (stop/operate) button.
OPERATION INDICATOR lamp of the indoor unit turns on with a beep tone.
- Select COOL mode with Operation select button.
- Press Temperature buttons TEMP \ominus or \oplus button to select the desired temperature. The setting range is 16 - 31°C.

1. Coil frost prevention

The compressor operational frequency is controlled by the temperature of the indoor heat exchanger to prevent the coil from frosting.

When the temperature of indoor heat exchanger becomes too low, the coil frost prevention mode works.

The indoor fan operates at the set speed and the compressor stops. This mode continues until the temperature of indoor heat exchanger rises.

2. Low outside temperature operation

When the outside temperature is lower, low outside temperature operation starts, and the outdoor fan slows or stops.

3. Indoor fan speed control

When the thermostat turns OFF, the indoor fan operates very Low to reduce power consumption.

When the room temperature rises and the thermostat is ON, the indoor fan operates according to the settings on the remote controller.

9-2. DRY (△) OPERATION

(1) Press OFF/ON (stop/operate) button.

OPERATION INDICATOR lamp of the indoor unit turns on with a beep tone.

(2) Select DRY mode with Operation select button.

(3) The set temperature is determined from the initial room temperature.

1. Coil frost prevention

Coil frost prevention works the same way as that in COOL mode. (9-1.1.)

2. Low outside temperature operation

Low outside temperature operation works the same way as that in COOL mode. (9-1.2.)

3. Indoor fan speed control

Indoor fan speed control works the same way as that in COOL mode. (9-1.3.)

9-3. FAN (✳) OPERATION

(1) OPERATION INDICATOR lamp of the indoor unit turns on with a beep tone.

(2) Select FAN mode with Operation select button.

(3) Select the desired fan speed. When AUTO, it becomes Low.

Only indoor fan operates.

Outdoor unit does not operate.

9-4. HEAT (☀) OPERATION

(1) Press OFF/ON (stop/operate) button.

OPERATION INDICATOR lamp of the indoor unit turns on with a beep tone.

(2) Select HEAT mode with Operation select button.

(3) Press Temperature buttons TEMP \ominus or \oplus button to select the desired temperature. The setting range is 10 - 31°C.

1. Cold air prevention control

When the compressor is not operating or is starting, and the temperature of indoor heat exchanger and/or the room temperature is low or when defrosting is being done, the indoor fan will stop or rotate in Very Low speed.

2. High pressure protection

The compressor operational frequency is controlled by the temperature of the indoor heat exchanger to prevent the condensing pressure from increasing excessively.

When the temperature of indoor heat exchanger becomes too high, the high pressure protection works.

The indoor fan operates following the cold air prevention control. This mode continues until the temperature of indoor heat exchanger falls.

3. Defrosting

Defrosting starts when the temperature of outdoor heat exchanger becomes too low.

The compressor stops once, the indoor/outdoor fans stop, the 4-way valve reverses, and the compressor re-starts.

This mode continues until the temperature of outdoor heat exchanger rises or the fixed time passes.

9-5. AUTO CHANGE OVER ... AUTO MODE OPERATION

Once desired temperature is set, unit operation is switched automatically between COOL and HEAT operation.

Mode selection

(1) Initial mode

When unit starts the operation with AUTO operation from OFF:

- If the room temperature is higher than the set temperature, operation starts in COOL mode.
- If the room temperature is equal to or lower than the set temperature, operation starts in HEAT mode.

(2) Mode change

COOL mode changes to HEAT mode when about 15 minutes have passed with the room temperature 1°C below the set temperature.

HEAT mode changes to COOL mode when about 15 minutes have passed with the room temperature 1°C above the set temperature.

NOTE 1

If 2 or more indoor units are operating in multi system, there might be a case that the indoor unit, which is operating in □ (AUTO), cannot change over to the other operating mode (COOL ↔ HEAT) and becomes a state of standby.

Refer to **NOTE 2 "FOR MULTI SYSTEM AIR CONDITIONER"**.

NOTE 2

FOR MULTI SYSTEM AIR CONDITIONER

OUTDOOR UNIT: MXZ series

Multi system air conditioner can connect 2 or more indoor units with 1 outdoor unit.

- When you try to operate 2 or more indoor units with 1 outdoor unit simultaneously, one for the cooling and the others for heating, the operation mode of the indoor unit that operates first is selected. Other indoor units cannot operate, and operation indicator lamp blinks as shown in the figure below. In this case, please set all the indoor units to the same operation mode.

OPERATION INDICATOR

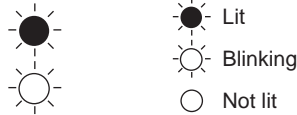

- When indoor unit starts the operation while the defrosting of outdoor unit is being done, it takes a few minutes (max. 10 minutes) to blow out the warm air.
- In the heating operation, though indoor unit is not operating, it may get warm or the sound of refrigerant flow may be heard. It is not malfunction. The reason is that the refrigerant continuously flows into it.

9-6. AUTO VANE OPERATION

1. Horizontal vane

(1) Vane motor drive

These models are equipped with a stepping motor for the horizontal vane. The rotating direction, speed, and angle of the motor are controlled by pulse signals (approximately 12 V) transmitted from indoor microprocessor.

- (2) The horizontal vane angle and mode change as follows by pressing Up-down airflow control button.

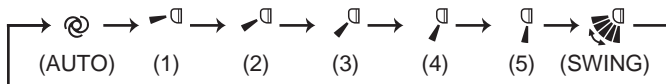

(3) Positioning

To confirm the standard position, the vane moves until it touches the vane stopper. Then the vane is set to the selected angle.

Confirming of standard position is performed in the following cases:

- (a) When the operation starts or finishes (including timer operation).
- (b) When the test run starts.
- (c) When standby mode (only during multi system operation) starts or finishes.

(4) VANE AUTO (@) mode

In VANE AUTO mode, the microprocessor automatically determines the vane angle to make the optimum room temperature distribution.

In COOL and DRY operation
Vane angle is fixed to Horizontal position.



In HEAT operation
Vane angle is fixed to Angle 4.



(5) STOP (operation OFF) and ON TIMER standby

In the following cases, the horizontal vane returns to the closed position.

- (a) When OFF/ON (stop/operate) button is pressed (POWER OFF).
- (b) When the operation is stopped by the emergency operation.
- (c) When ON TIMER is ON standby.

(6) Dew prevention

During COOL or DRY operation with the vane angle at Angle 5 when the compressor cumulative operation time exceeds 1 hour, the vane angle automatically changes to Angle 4 for dew prevention.

(7) SWING (fan icon) mode

By selecting SWING mode with Up-down airflow control button, the horizontal vanes swing vertically.

When COOL, DRY or FAN mode is selected, only the upper vane swings.

(8) Cold air prevention in HEAT operation

The horizontal vane position is set to upward.

NOTE: When 2 or more indoor units are operated with multi outdoor unit, even if any indoor unit turns thermostat off, this control does not work in the indoor unit.

(9) ECONO COOL (ECONOMICAL operation)

When ECONO COOL button is pressed in COOL mode, set temperature is automatically set 2°C higher by the microprocessor. (However, the temperature on the LCD screen on the remote controller is not changed.)

Also the horizontal vane swings in various cycle.

SWING operation makes you feel cooler than set temperature. So, even though the set temperature is higher, the air conditioner can keep comfort. As a result, energy can be saved.

To cancel this operation, select a different mode or press one of the following buttons in ECONO COOL operation: ECONO COOL, or Up-down airflow control button.

2. Vertical vane

(1) Vane motor drive

These models are equipped with a stepping motor for the vertical vane. The rotating direction, speed, and angle of the motor are controlled by pulse signals (approximately 12 V) transmitted from microprocessor.

(2) The vertical vane angle and mode change as follows by pressing Left-right airflow control button.

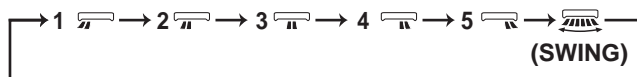

(3) Positioning

To confirm the standard position, the vane moves until it touches the vane stopper. Then the vane is set to the selected angle.

Confirmation of standard position is performed in the following cases:

(a) OFF/ON (stop/operate) button is pressed (POWER ON).

(4) SWING (SWING) MODE

By selecting SWING mode with Left-right airflow control button, the vertical vane swings horizontally. The remote controller displays "SWING". Swing mode is cancelled when Left-right airflow control button is pressed once again.

9-7. TIMER OPERATION

1. How to set the time

(1) Check that the current time is set correctly.

NOTE: Timer operation will not work without setting the current time. Initially "0:00" blinks at the current time display of TIME MONITOR, so set the current time correctly with CLOCK button.

How to set the current time

(a) Press the CLOCK button.

(b) Press the TIME SET buttons (UP and DOWN) to set the current time.

- Each time FORWARD button (UP) is pressed, the set time increases by 1 minute, and each time BACKWARD button (DOWN) is pressed, the set time decreases by 1 minute.

- Pressing those buttons longer, the set time increases/decreases by 10 minutes.

(c) Press the CLOCK button.

(2) Press OFF/ON (stop/operate) button to start the air conditioner.

(3) Set the time of timer.

ON timer setting

(a) Press ON TIMER button (ON) during operation.

(b) Set the time of the timer using TIME SET buttons (UP and DOWN). *

OFF timer setting

(a) Press OFF TIMER button (OFF) during operation.

(b) Set the time of the timer using TIME SET buttons (UP and DOWN). *

* Each time FORWARD button (UP) is pressed, the set time increases by 10 minutes: each time BACKWARD button (DOWN) is pressed, the set time decreases by 10 minutes.

2. To release the timer

To release ON timer, press ON TIMER button (ON).

To release OFF timer, press OFF TIMER button (OFF).

TIMER is cancelled and the display of set time disappears.

PROGRAM TIMER

- OFF timer and ON timer can be used in combination. The set time that is reached first will operate first.
- “←” and “→” display shows the order of OFF timer and ON timer operation.

(Example 1) The current time is 8:00 PM.
The unit turns off at 11:00 PM, and on at 6:00 AM.

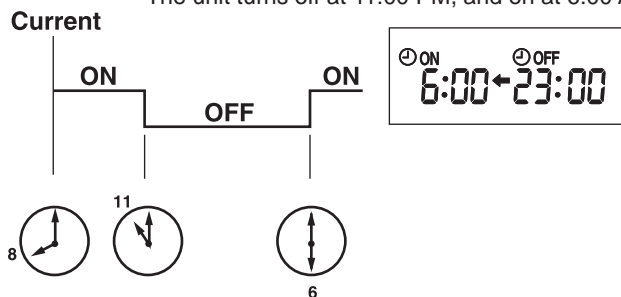

(Example 2) The current time is 11:00 AM.
The unit turns on at 5:00 PM, and off at 9:00 PM.

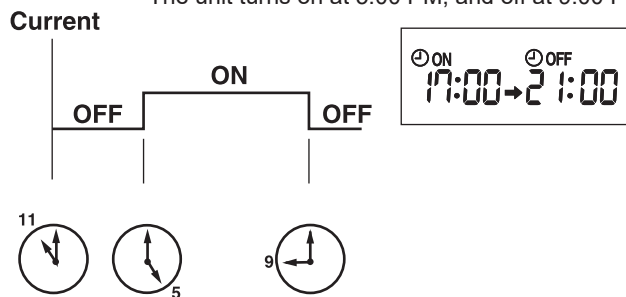

NOTE: If the main power is turned OFF or a power failure occurs while ON/OFF timer is active, the timer setting is cancelled. As these models are equipped with an auto restart function, the air conditioner starts operating with timer cancelled when power is restored.

9-8. WEEKLY TIMER OPERATION

- A maximum of 4 ON or OFF timers can be set for individual days of the week.
- A maximum of 28 ON or OFF timers can be set for a week.

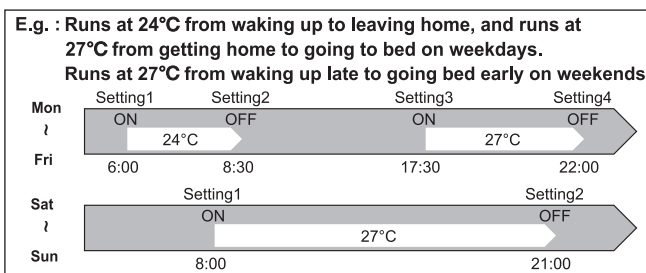

NOTE:

- The simple ON/OFF timer setting is available while the weekly timer is on. In this case, the ON/OFF timer has priority over the weekly timer; the weekly timer operation will start again after the simple ON/OFF timer is complete.

1. How to set the weekly timer

* Make sure that the current time and day are set correctly.

(1) Press **EDIT/SEND** button to enter the weekly timer setting mode.

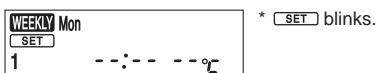

(2) Press **DAY** and **1~4** buttons to select setting day and number.

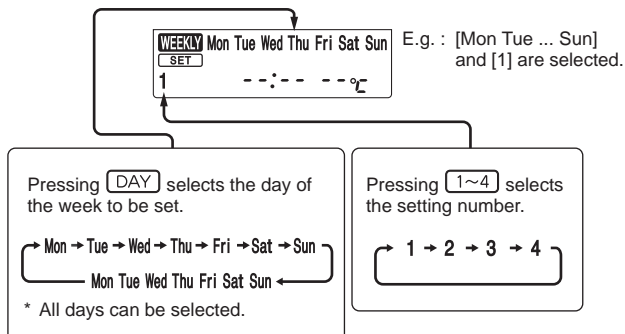

(3) Press , , and buttons to set ON/OFF, time, and temperature.

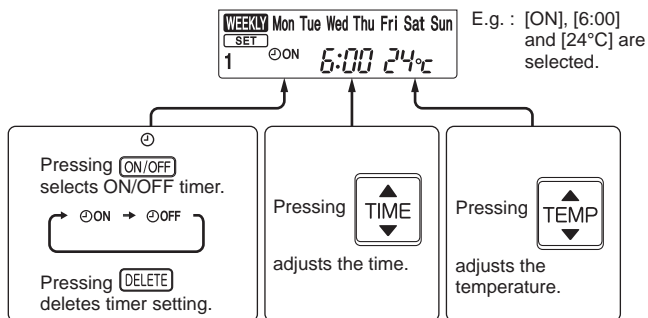

- * Hold down the button to change the time quickly.
- * The temperature can be set between 16°C and 31°C at cool operation.
- * The temperature can be set between 10°C and 31°C at heat operation.

Press and buttons to continue setting the timer for other days and/or numbers.

(4) Press button to complete and transmit the weekly timer setting.

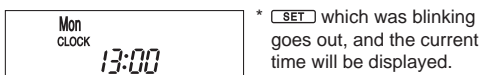

NOTE:

- Press button to transmit the setting information of weekly timer to the indoor unit. Point the remote controller toward the indoor unit for 3 seconds.
- When setting the timer for more than one day of the week or one number, button does not have to be pressed per each setting. Press button once after all the settings are complete. All the weekly timer settings will be saved.
- Press button to enter the weekly timer setting mode, and press and hold button for 5 seconds to erase all weekly timer settings. Point the remote controller toward the indoor unit.

(5) Press button to turn the weekly timer ON. (.)

- When the weekly timer is ON, the day of the week whose timer setting is complete, will light.

Press button again to turn the weekly timer OFF. (goes out.)

NOTE:

The saved settings will not be cleared when the weekly timer is turned OFF.

2. Checking weekly timer setting

(1) Press button to enter the weekly timer setting mode.

* blinks.

(2) Press or buttons to view the setting of the particular day or number.

(3) Press button to exit the weekly timer setting.

NOTE:

When all days of the week are selected to view the settings and a different setting is included among them, °C will be displayed.

9-9. NIGHT MODE (🌙) OPERATION

NIGHT MODE changes the brightness of the operation indicator, disables the beep sound and limits the noise level of the outdoor unit.

(1) Press NIGHT MODE button during operation to activate NIGHT MODE (🌙).

- The operation indicator lamp dims.
- The beep sound will be disabled except that emitted when the operation is started or stopped.
- Noise level of the outdoor unit will be lower than that mentioned in SPECIFICATIONS. (Except the connection to MXZ.)

(2) Press NIGHT MODE button to cancel NIGHT MODE (🌙).

NOTE:

- Noise level of the outdoor unit may not change after startup of the unit, during the protection operation, or depending on other operating conditions.
- The fan speed of the indoor unit will not change.
- The operation indicator lamp will be hard to be seen in a bright room.
- Noise level of the outdoor unit will not decrease during Multi system operation.

9-10. i-save (i) OPERATION

1. How to set i-save operation

- (1) Press OFF/ON (stop/operate) button.
- (2) Select COOL, HEAT or ECONO COOL mode.
- (3) Press i-save button.
- (4) Set the temperature, fan speed, and airflow direction for i-save operation.

NOTE:



- i-save operation cannot be selected during DRY or AUTO mode operation.
- The setting range of HEAT mode i-save operation is 10 - 31°C.
- 2 groups of setting can be saved. (One for COOL/ECONO COOL, one for HEAT)

2. How to cancel operation



- Press i-save button again.
- i-save operation can also be cancelled by pressing Operation select button to change the operation mode. The preferred setting can be saved for the next time with a single press of i-save button.

9-11. OPERATION LOCK

This function locks operation mode only. Other functions, such as OFF/ON, temperature setting, or airflow direction adjustment, are available.

- (1) Hold down  button and  button simultaneously for 2 seconds while the unit is not operating to enable OPERATION LOCK.

The icon for the locked operation mode blinks.

- (2) Hold down  button and  button simultaneously for 2 seconds again while the unit is not operating to disable OPERATION LOCK.

- The icon for the locked operation mode blinks when  button and  button are held down to enable or disable OPERATION LOCK or  button is pressed during operation while OPERATION LOCK is enabled.
- AIR PURIFYING operation is not available when OPERATION LOCK is enabled in a mode other than FAN mode.

9-12. AIR PURIFYING (+) OPERATION (MSZ-AY-VGKP)

In the AIR PURIFYING operation, the indoor unit built-in device reduces airborne fungi, viruses, mold, and allergens.

- (1) Press PURIFIER button to start AIR PURIFYING operation.
 - AIR PURIFYING lamp turns on. (Display section)
- (2) Press PURIFIER button again to cancel AIR PURIFYING operation.
 - AIR PURIFYING lamp turns off. (Display section)

NOTE:

- Never touch the air purifying device during operation. Although the air purifying device is safety-conscious design, touching this device could be the cause of trouble as this device discharge high voltage electricity.
- A "hissing" sound may be heard during the air purifying operation. This sound is produced when plasma is being discharged. This is not a malfunction.
- AIR PURIFYING lamp does not turn on if the front panel is not closed completely.

9-13. SELF CLEAN () OPERATION

- When SELF CLEAN operation is set, it performs for 25 minutes when unit is stopped after COOL/DRY operation. SELF CLEAN operation performs when: COOL/DRY is operated more than 3 minutes.
- The fan is stopped for the first 3 minutes. Then, the horizontal vane is set to higher than angle 1 and the fan is operated for 25 minutes.

9-14. EMERGENCY/TEST OPERATION

In the case of test run operation or the emergency operation, use the emergency operation switch on the right side of the indoor unit. The emergency operation is available when the remote controller is missing or has failed, or the batteries in the remote controller are running down. The unit will start and OPERATION INDICATOR lamp will light up.

The first 30 minutes of operation is the test run operation. This operation is for servicing. The indoor fan runs at High speed and the temperature control does not work.

After 30 minutes of test run operation, the system shifts to EMERGENCY COOL/HEAT MODE with a set temperature of 24°C. The fan speed shifts to Med.

The coil frost prevention works even in the test run or the emergency operation.

In the test run or the emergency operation, the horizontal vane operates in VANE AUTO (Ⓢ) mode.

The emergency operation continues until the emergency operation switch is pressed once or twice or the unit receives any signal from the remote controller. In the latter case, normal operation will start.

NOTE: Do not press the emergency operation switch during normal operation.

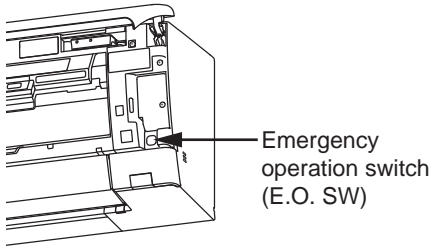

Operation mode	COOL/HEAT
Set temperature	24°C
Fan speed	Med.
Horizontal vane	Auto

The operation mode is indicated by the Operation Indicator lamp as following

Operation Indicator lamp

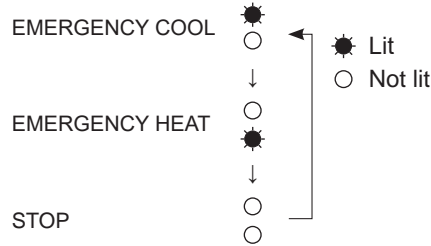

9-15. 3-MINUTE TIME DELAY OPERATION

When the system turns OFF, compressor will not restart for 3 minutes as 3-minute time delay function operates to protect compressor from overload.

MSZ-AY25VGK MSZ-AY35VGK MSZ-AY42VGK MSZ-AY50VGK MSZ-AY25VGKP MSZ-AY35VGKP MSZ-AY42VGKP MSZ-AY50VGKP

10-1. CAUTIONS ON TROUBLESHOOTING

1. Before troubleshooting, check the following

- 1) Check the power supply voltage.
- 2) Check the indoor/outdoor connecting wire for miswiring.

2. Take care of the following during servicing

- 1) Before servicing the air conditioner, be sure to turn OFF the main unit first with the remote controller, and after confirming the horizontal vane is closed, turn OFF the breaker and/or disconnect the power plug.
- 2) Be sure to turn OFF the power supply before removing the front panel, the cabinet, the top panel, and the P.C. board.
- 3) When removing the P.C. board, hold the edge of the board with care NOT to apply stress on the components.
- 4) When connecting or disconnecting the connectors, hold the connector housing. DO NOT pull the lead wires.

<Incorrect>



Lead wiring

<Correct>



Connector housing

3. Troubleshooting procedure

- 1) Check if the OPERATION INDICATOR lamp on the indoor unit is blinking ON and OFF to indicate an abnormality. To make sure, check how many times the OPERATION INDICATOR lamp is blinking ON and OFF before starting service work.
- 2) Before servicing, verify that all connectors and terminals are connected properly.
- 3) When the electronic control P.C. board seems to be defective, check for disconnection of the copper foil pattern and burnt or discolored components.
- 4) When troubleshooting, refer to 10-2, 10-3 and 10-4.

4. How to replace batteries

Weak batteries may cause the remote controller malfunction.

In this case, replace the batteries to operate the remote controller normally.

- ① Remove the front lid and insert batteries. Then reattach the front lid.

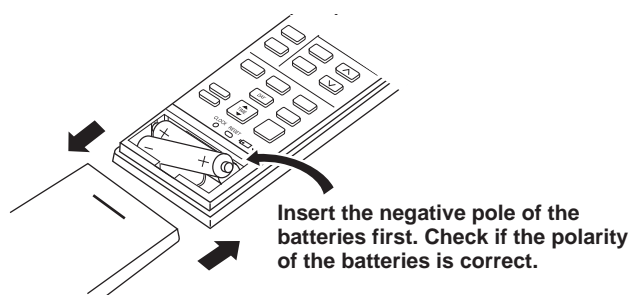

- ② Press RESET button with a fine-tipped object, and then use the remote controller.

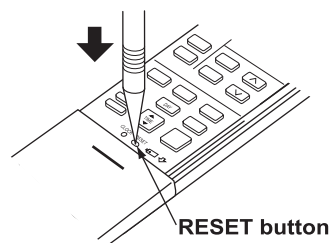

NOTE: 1. If RESET button is not pressed, the remote controller may not operate correctly.

2. This remote controller has a circuit to automatically reset the microcomputer when batteries are replaced.

This function is equipped to prevent the microcomputer from malfunctioning due to the voltage drop caused by the battery replacement.

3. Do not use the leaking batteries.

10-2. FAILURE MODE RECALL FUNCTION

Outline of the function

This air conditioner can memorize the abnormal condition which has occurred once.

Even though LED indication listed on the troubleshooting check table (10-4.) disappears, the memorized failure details can be recalled.

1. Flow chart of failure mode recall function for the indoor/outdoor unit

NOTE: The indoor unit does not operate by smartphone, refer to 10-3.2. "Check of Wi-Fi interface".

MSZ-AY25/35/42/50VGK
MSZ-AY25/35/42/50VGKP

Operational procedure

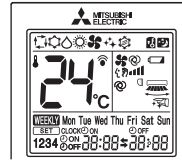
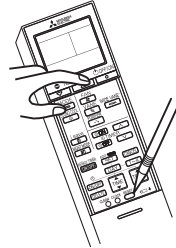
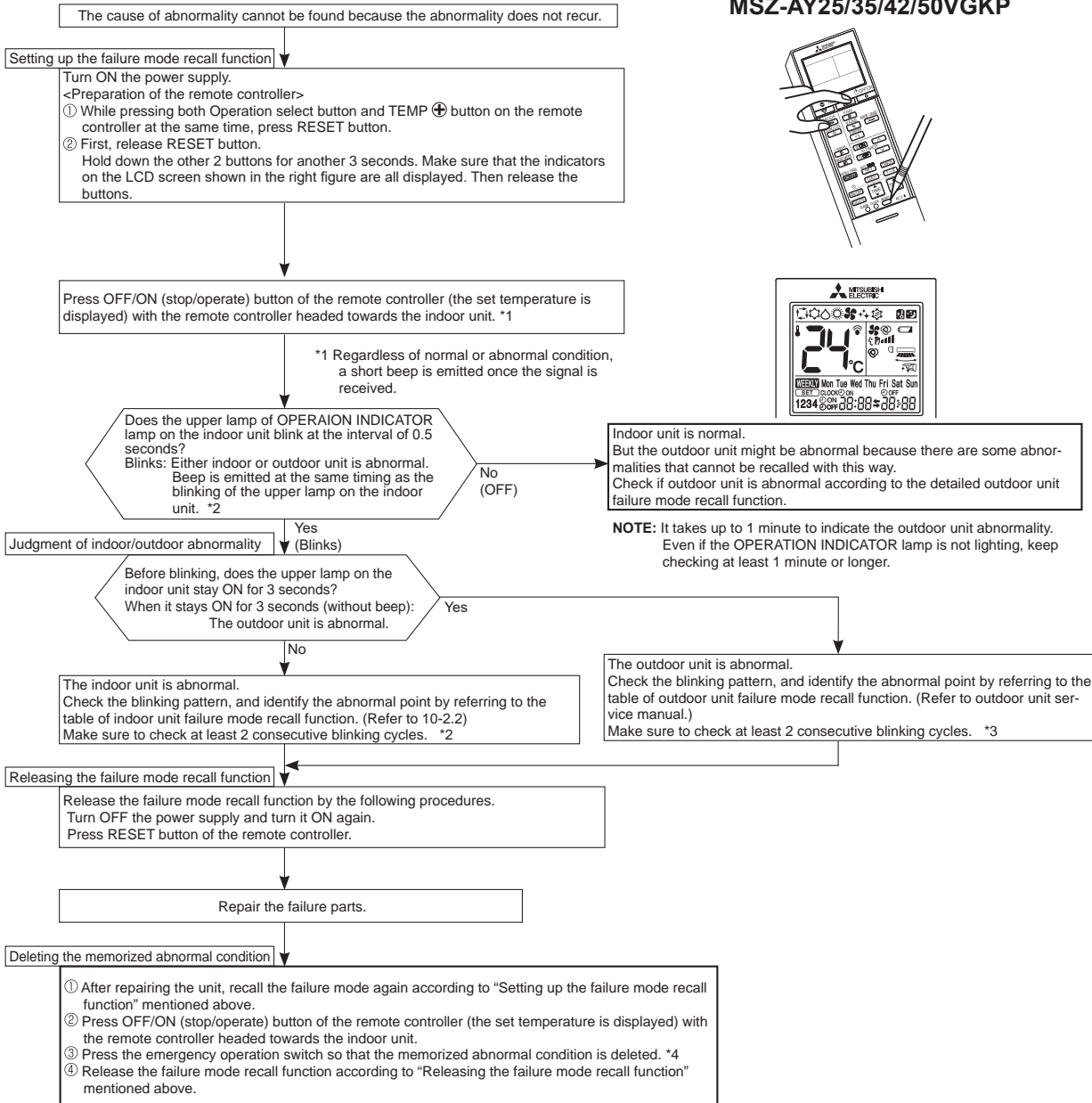

*2. Blinking pattern when the indoor unit is abnormal:

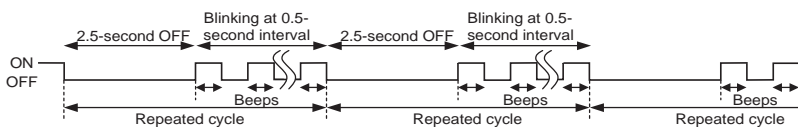

*3. Blinking pattern when the outdoor unit is abnormal:

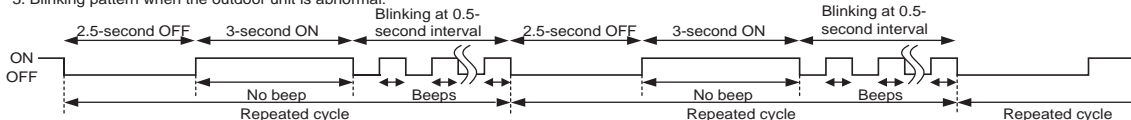

*4 The information regarding whether the connected outdoor unit is a low-standby-power model or a non-low-standby-power model will also be initialized. (Default= compatible with a low-standby-power model)

2. Flow chart of AIR PURIFYING power failure mode recall function (MSZ-AY•VGKP)

Operational procedure

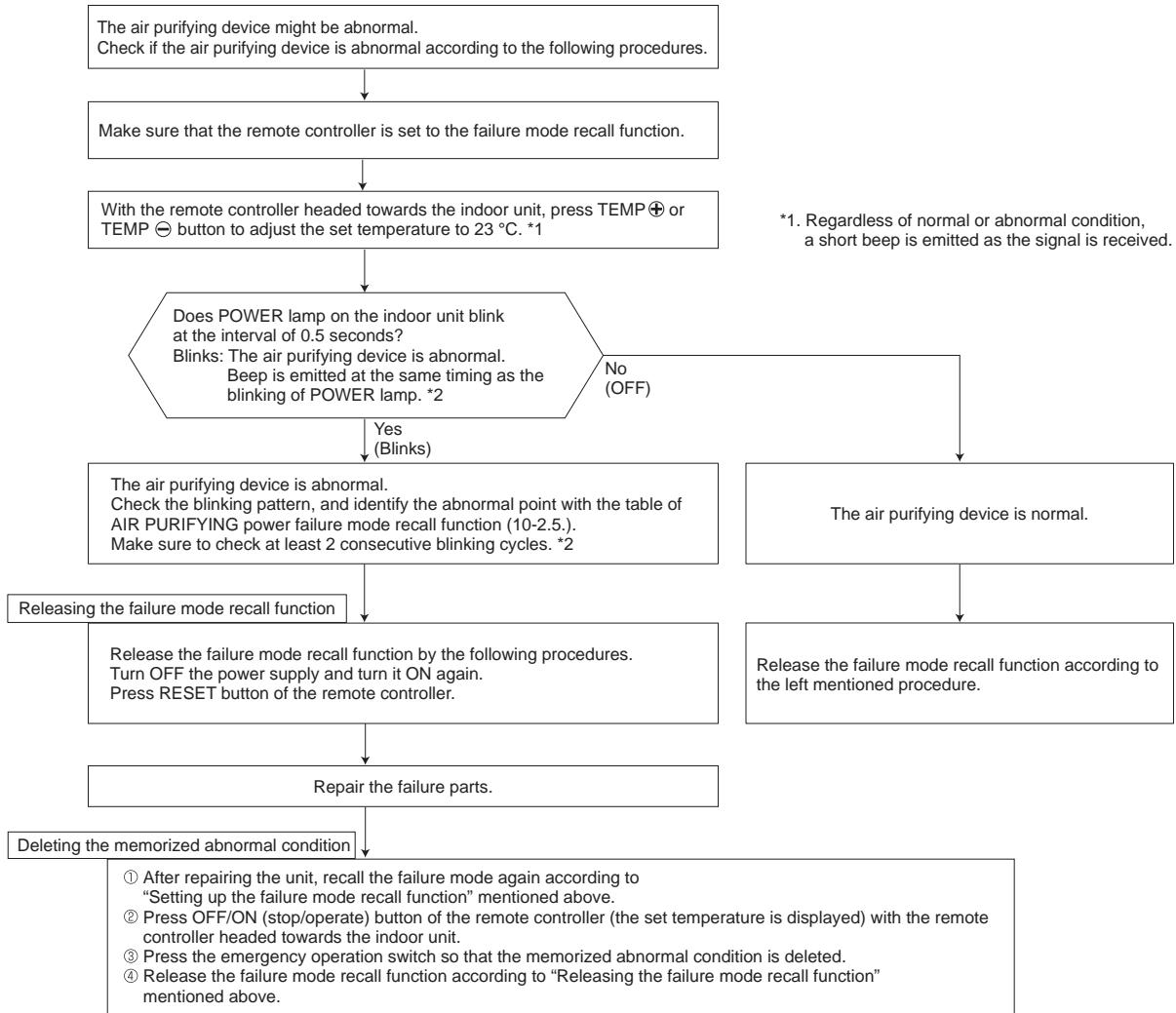

Note 1: Make sure to release the failure mode recall function after it is set up, otherwise the unit cannot operate properly.

Note 2: If the abnormal condition is not deleted from the memory, the last abnormal condition is kept memorized.

*2. Blinking pattern when the air purifying device is abnormal:

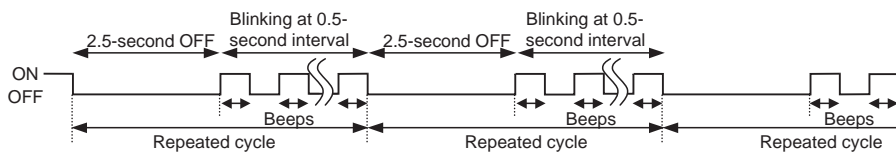

3. AIR PURIFYING power operation check

AIR PURIFYING power operation goes ON when PURIFIER button on the remote controller is pressed with any set temperature displayed during failure mode recall function.

Check the operation display section of the remote controller to confirm that AIR PURIFYING power operation is activated. While AIR PURIFYING lamp stays OFF, it means normal.

Blinking AIR PURIFYING lamp means abnormal, the AIR PURIFYING power operation is not conducted.

AIR PURIFYING lamp	Remedy
Continuously blinking	Follow "Check of AIR PURIFYING power" to identify the error. (Refer to 10-6.Ⓔ.)
2-time blink	AIR PURIFYING power control circuit on the indoor electronic control P.C. board is out of order. (Refer to 10-6.Ⓔ.)

NOTE: Perform the above mentioned check with the front panel closed. The interlock switch (Air purifying device) works by opening front panel and the AIR PURIFYING power is cut.

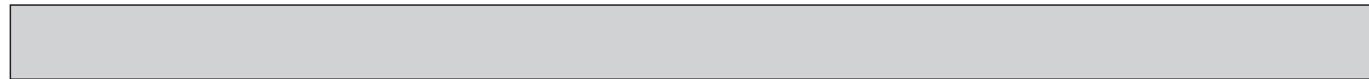

4. Table of indoor unit failure mode recall function

NOTE: Blinking patterns of this mode differ from the ones of TROUBLESHOOTING CHECK TABLE (10-4.).

The upper lamp of OPERATION INDICATOR lamp	Abnormal point (Failure mode)	Condition	Remedy
Not lit	Normal	—	—
1-time blink every 0.5-second	Room temperature thermistor	The room temperature thermistor short or open circuit is detected every 8 seconds during operation.	Refer to the characteristics of the room temperature thermistor (10-7.).
2-time blink 2.5-second OFF	Indoor coil thermistor	The indoor coil thermistor short or open circuit is detected every 8 seconds during operation.	Refer to the characteristics of the main indoor coil thermistor, the sub indoor coil thermistor (10-7.).
3-time blink 2.5-second OFF	Serial signal	The serial signal from outdoor unit is not received for a maximum of 6 minutes.	Refer to 10-6.Ⓣ “How to check miswiring and serial signal error”.
11-time blink 2.5-second OFF	Indoor fan motor	The rotational frequency feedback signal is not emitted for 12 seconds after the indoor fan motor is operated.	Refer to 10-6.ⓐ “Check of indoor fan motor”.
12-time blink 2.5-second OFF	Indoor control system	It cannot properly read data in the nonvolatile memory of the indoor electronic control P.C. board.	Replace the indoor electronic control P.C. board.

5. Table of indoor unit failure mode recall function (When recalled at a set temperature of 23°C)

Table of AIR PURIFYING power failure mode recall function

POWER lamp	Abnormal point (Failure mode)	Condition	Remedy
1-time blink	AIR PURIFYING power control	When AIR PURIFYING power cannot be turned OFF even if the AIR PURIFYING operation is turned OFF with the remote controller.	Refer to 10-6.Ⓢ “Check of AIR PURIFYING power”.
2-time blink	Electrode (Spark discharge)	When the voltage between CN1T1 Ⓝ (+) and Ⓜ (GND) on the electronic P.C. board falls below 1.3V (spark discharge judgment voltage).	
3-time blink	Electrode (Abnormal electric discharge error 1)	When the voltage between CN1T1 Ⓝ (+) and Ⓜ (GND) on the electronic P.C. board falls by 1.2V below the normal voltage value (2.5V).	
4-time blink	Electrode (Abnormal electric discharge error 2)	When the voltage between CN1T1 Ⓝ (+) and Ⓜ (GND) on the electronic P.C. board falls significantly. (0.4V / 0.5ms)	
5-time blink	AIR PURIFYING power	When the voltage between CN1T1 Ⓝ (+) and Ⓜ (GND) on the electronic P.C. board rises above 3V.	

NOTE1 : Blinking patterns of this mode differ from the ones of TROUBLESHOOTING CHECK TABLE (10-4.).

NOTE2 : As soon as an abnormality is detected, AIR PURIFYING power goes OFF, therefore measuring instrument which records the voltage wave is required in order to perform the above mentioned voltage measurement.

10-3. INSTRUCTION OF TROUBLESHOOTING

1. Check of the unit.

*1 "Test Run operation" means the operation within 30 minutes after the emergency operation switch is pressed.

*2 There is possibility that diesel explosion may occur due to the air mixed in the refrigerant circuit.
 First, ensure that there are no leakage points on the valves, flare connections, etc. that allow the air to flow into the refrigerant circuit, or no blockage points (e.g. clogged or closed valves) in the refrigerant circuit that cause an increase in pressure.
 If there is no abnormal point like above and the system operates cooling and heating modes normally, the indoor thermistor might have a problem, resulting in false detection.
 Check both the indoor coil thermistor and the room temperature thermistor, and replace faulty thermistor(s), if any.
NOTE: Do not start the operation again without repair to prevent hazards.

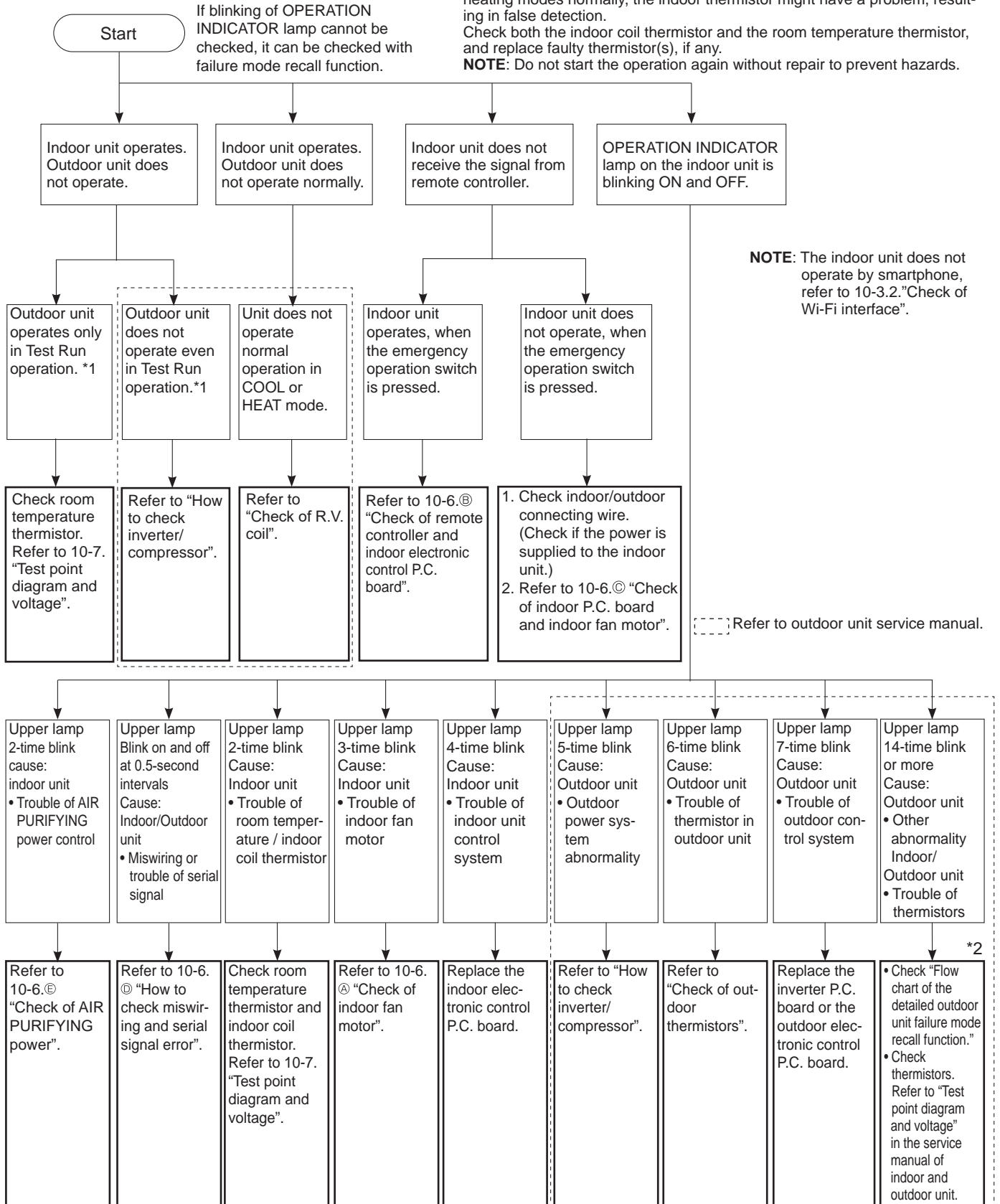

2. Check of Wi-Fi interface

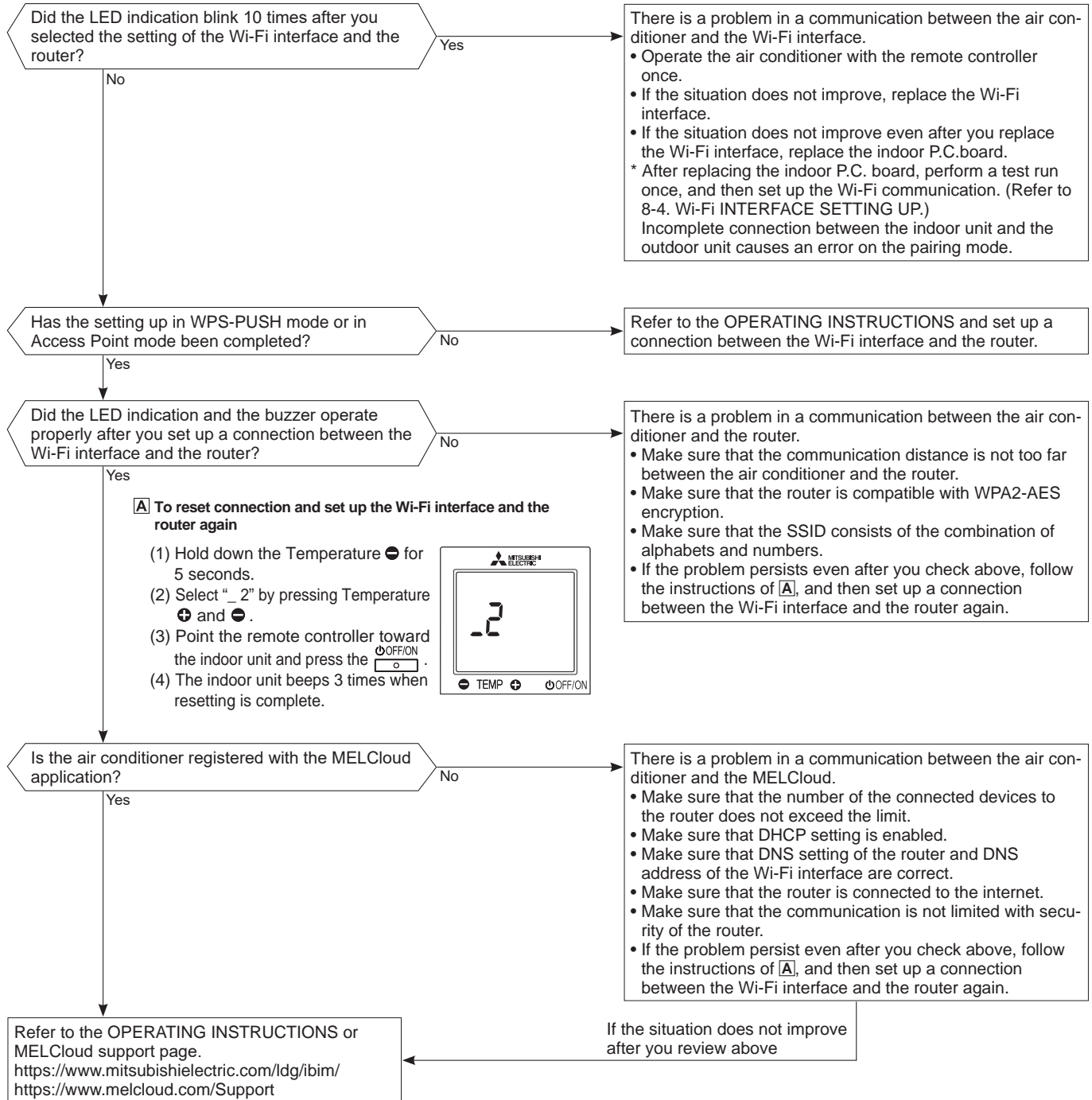

Follow the procedure below if the air conditioner cannot be monitored or controlled with a device such as a smartphone.







10-4. TROUBLESHOOTING CHECK TABLE

Before taking measures, make sure that the symptom reappears for accurate troubleshooting.

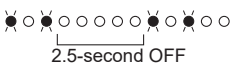
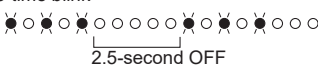
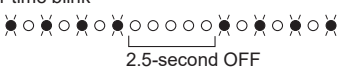
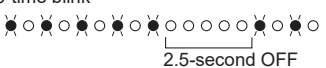
When the indoor unit has started operation and detected an abnormality of the following condition (the first detection after the power ON), the indoor fan motor turns OFF and OPERATION INDICATOR lamp blinks.

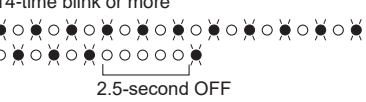
OPERATION INDICATOR  Lit
 Blinking
 Not lit

No.	Abnormal point	Operation indicator lamp	Symptom	Condition	Remedy
1	Miswiring or serial signal	Upper lamp blinks. 0.5-second ON  0.5-second OFF	Indoor unit and outdoor unit do not operate.	The serial signal from the outdoor unit is not received for 6 minutes. The indoor unit is connected to a low-standby-power model after once connected to a non-low-standby-power model.	<ul style="list-style-type: none"> Refer to 10-6. ③ "How to check miswiring and serial signal error". Refer to NOTE.
2	Indoor coil thermistor Room temperature thermistor	Upper lamp blinks. 2-time blink  2.5-second OFF		The indoor coil or the room temperature thermistor is short or open circuit.	<ul style="list-style-type: none"> Refer to the characteristics of indoor coil thermistor, and the room temperature thermistor (10-7.).
3	Indoor fan motor	Upper lamp blinks. 3-time blink  2.5-second OFF		The rotational frequency feedback signal is not emitted during the indoor fan operation.	<ul style="list-style-type: none"> Refer to 10-6. ④ "Check of indoor fan motor".
4	Indoor control system	Upper lamp blinks. 4-time blink  2.5-second OFF		It cannot properly read data in the nonvolatile memory of the indoor electronic control P.C. board.	<ul style="list-style-type: none"> Replace the indoor electronic control P.C. board.
5	Outdoor power system	Upper lamp blinks. 5-time blink  2.5-second OFF		It consecutively occurs 3 times that the compressor stops for overcurrent protection or startup failure protection within 1 minute after startup.	<ul style="list-style-type: none"> Refer to "How to check of inverter/compressor". Refer to outdoor unit service manual Check the stop valve.
6	Outdoor thermistors	Upper lamp blinks. 6-time blink  2.5-second OFF		The outdoor thermistors short or open circuit during the compressor operation.	<ul style="list-style-type: none"> Refer to "Check of outdoor thermistor". Refer to outdoor unit service manual.
7	Outdoor control system	Upper lamp blinks. 7-time blink  2.5-second OFF		It cannot properly read data in the nonvolatile memory of the inverter P.C. board or the outdoor electronic control P.C. board.	<ul style="list-style-type: none"> Replace the inverter P.C. board or the outdoor electronic control P.C. board. Refer to outdoor unit service manual.
8	Other abnormality *2 on 10-3	Upper lamp blinks. 14-time blink or more  2.5-second OFF		An abnormality other than the above is detected. An abnormality of the indoor thermistors, the defrost thermistor or ambient temperature thermistor is detected.	<ul style="list-style-type: none"> Check the stop valve. Check the 4-way valve. Check the abnormality in detail using the failure mode recall function for outdoor unit. Refer to TEST POINT DIAGRAM AND VOLTAGE" on the service manual of indoor and outdoor unit for the characteristics of the thermistors. (Do not start the operation again without repair to prevent hazards.)
9	Outdoor control system	Upper lamp lights up 	Outdoor unit does not operate	It cannot properly read data in the nonvolatile memory of the inverter P.C. board or the outdoor electronic control P.C. board.	<ul style="list-style-type: none"> Check the blinking pattern of the LED on the inverter P.C. board or the outdoor electronic control P.C. board.

NOTE: The indoor unit may have been connected to a non-low-standby-power model outdoor unit. To use a low-standby-power model, clear the error history by referring to "Deleting the memorized abnormal condition" described in 10-2.1. When the error history is being cleared, the connection information also will be initialized. The indoor unit will be compatible with a low-standby-power model after initialization. If the operation indicator lamp continues to blink as shown in No.1 after the procedure, refer to 10-6. ③ "How to check miswiring and serial error".

OPERATION INDICATOR

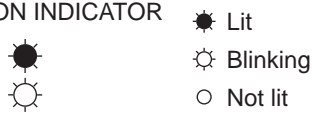

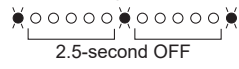
No.	Abnormal point	Operation indicator lamp	Symptom	Condition	Remedy
1	MXZ type Operation mode setting	Upper lamp lights and lower lamp blinks. 	Outdoor unit operates but indoor unit does not operate.	The operation mode of the each indoor unit is differently set to COOL (includes DRY) and HEAT at the same time, the operation mode of the indoor unit that has operated at first has the priority.	<ul style="list-style-type: none"> Unify the operation mode. Refer to outdoor unit service manual.

OPERATION INDICATOR

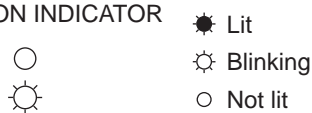

No.	Abnormal point	Operation indicator lamp	Symptom	Condition	Remedy
1	AIR PURIFYING power control	AIR PURIFYING lamp blinks. 	Indoor unit and outdoor unit do not operate.	When AIR PURIFYING power cannot be turned OFF even if the AIR PURIFYING operation is turned OFF by remote controller.	<ul style="list-style-type: none"> Refer to 10-6.Ⓔ "Check of AIR PURIFYING power".

10-5. TROUBLESHOOTING CRITERION OF MAIN PARTS

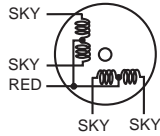
Part name	Check method and criterion	Figure			
Room temperature thermistor (RT11)	Measure the resistance with a multimeter.				
Indoor coil thermistor (RT12, RT13)	Refer to 10-7. "Test point diagram and voltage", "Indoor electronic control P.C. board", for the chart of thermistor.				
Indoor fan motor (MF)	Check 10-6.Ⓐ "Check of indoor fan motor".				
Vane motor (MV1) (Horizontal Upper)	Measure the resistance between the terminals with a multimeter. (Temperature: 10 to 30°C)				
	<table border="1"> <tr> <td>Color of the lead wire</td> <td>Normal</td> </tr> <tr> <td>RED - SKY*</td> <td>262 - 328 Ω</td> </tr> </table>		Color of the lead wire	Normal	RED - SKY*
Color of the lead wire	Normal				
RED - SKY*	262 - 328 Ω				
Vane motor (MV2) (Horizontal Lower)	Measure the resistance between the terminals with a multimeter. (Temperature: 10 to 30°C)				
	<table border="1"> <tr> <td>Color of the lead wire</td> <td>Normal</td> </tr> <tr> <td>RED - SKY*</td> <td>257 - 333 Ω</td> </tr> </table>	Color of the lead wire	Normal	RED - SKY*	257 - 333 Ω
Color of the lead wire	Normal				
RED - SKY*	257 - 333 Ω				
Vane motor (MV3) (Vertical)	Measure the resistance between the terminals with a multimeter. (Temperature: 10 to 30°C)				
	<table border="1"> <tr> <td>Color of the lead wire</td> <td>Normal</td> </tr> <tr> <td>RED - SKY*</td> <td>219 - 273 Ω</td> </tr> </table>	Color of the lead wire	Normal	RED - SKY*	219 - 273 Ω
Color of the lead wire	Normal				
RED - SKY*	219 - 273 Ω				
AIR PURIFYING power	Check 10-6.Ⓔ.				

*SKY = SKY BLUE

10-6. TROUBLESHOOTING FLOW

A Check of indoor fan motor

The indoor fan motor error has occurred, and the indoor fan does not operate.

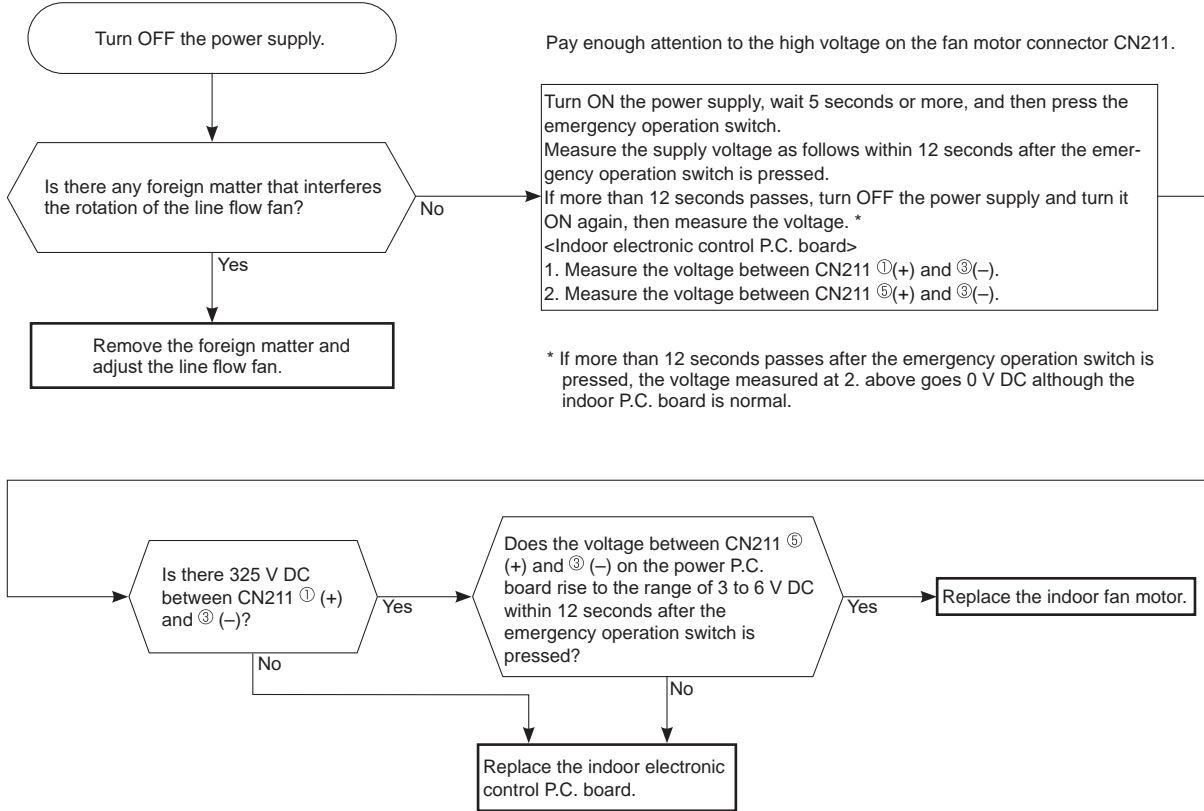

The indoor fan motor error has occurred, and the indoor fan repeats "12-second ON and 30-second OFF" 3 times, and then stops.

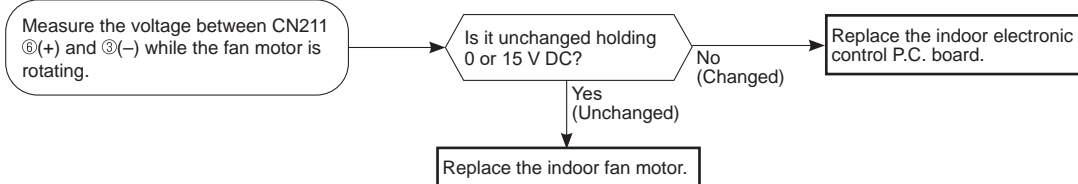

B Check of remote controller and indoor electronic control P.C. board

*Check if the remote controller is exclusive for this air conditioner.

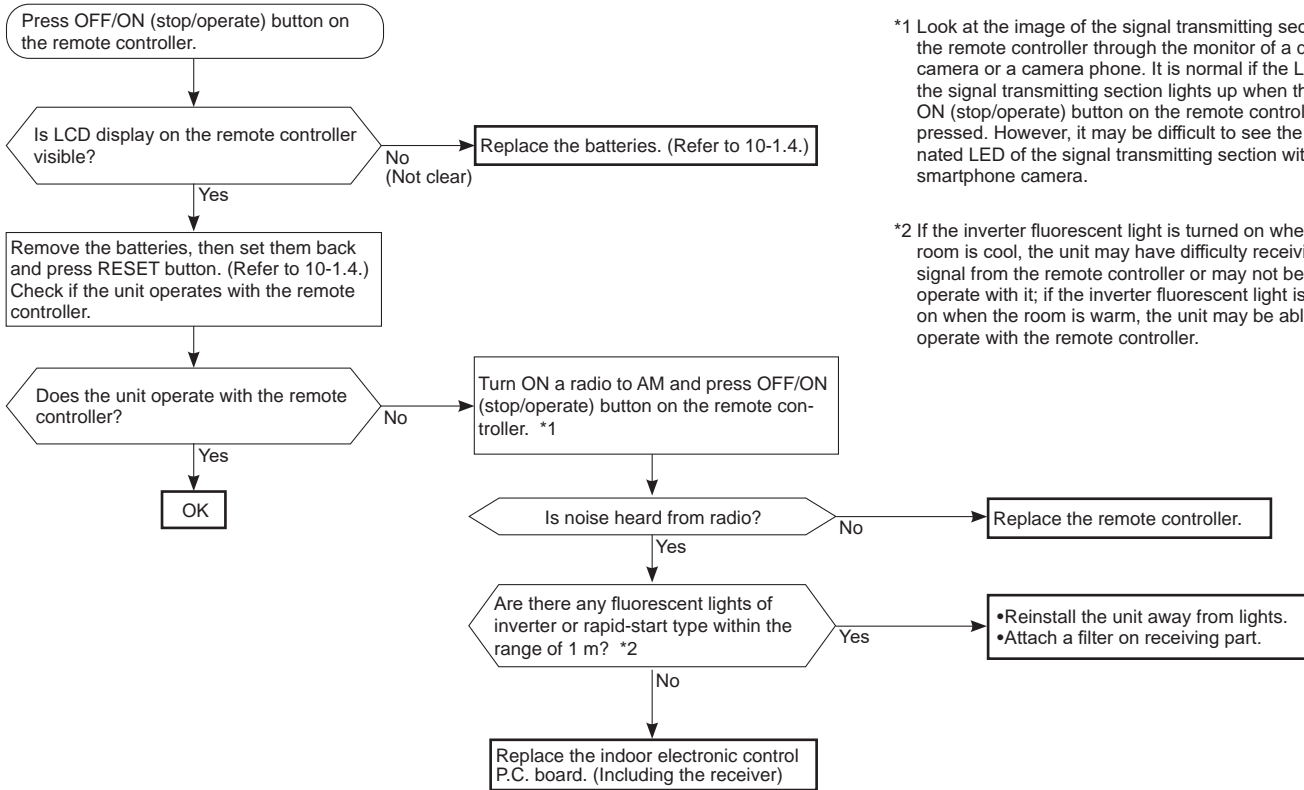

*1 Look at the image of the signal transmitting section of the remote controller through the monitor of a digital camera or a camera phone. It is normal if the LED of the signal transmitting section lights up when the OFF/ON (stop/operate) button on the remote controller is pressed. However, it may be difficult to see the illuminated LED of the signal transmitting section with a smartphone camera.

*2 If the inverter fluorescent light is turned on when the room is cool, the unit may have difficulty receiving the signal from the remote controller or may not be able to operate with it; if the inverter fluorescent light is turned on when the room is warm, the unit may be able to operate with the remote controller.

© Check of indoor P.C. board and indoor fan motor

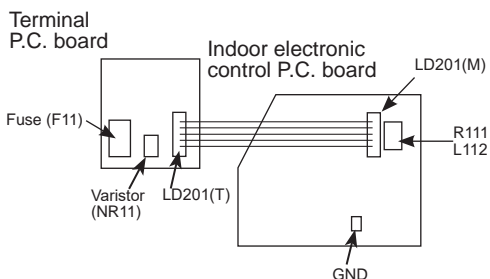
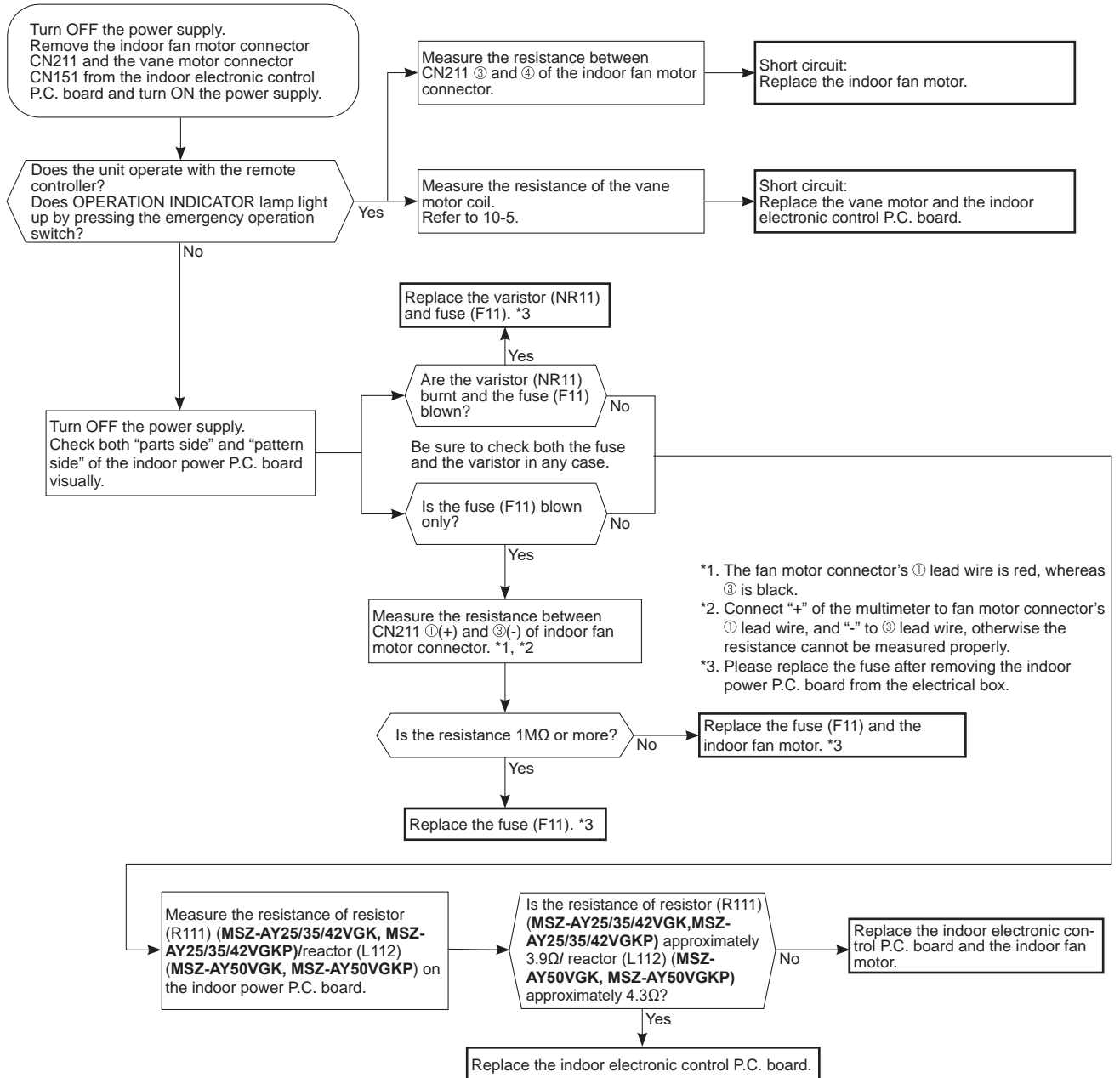

D How to check miswiring and serial signal error

MUZ Type

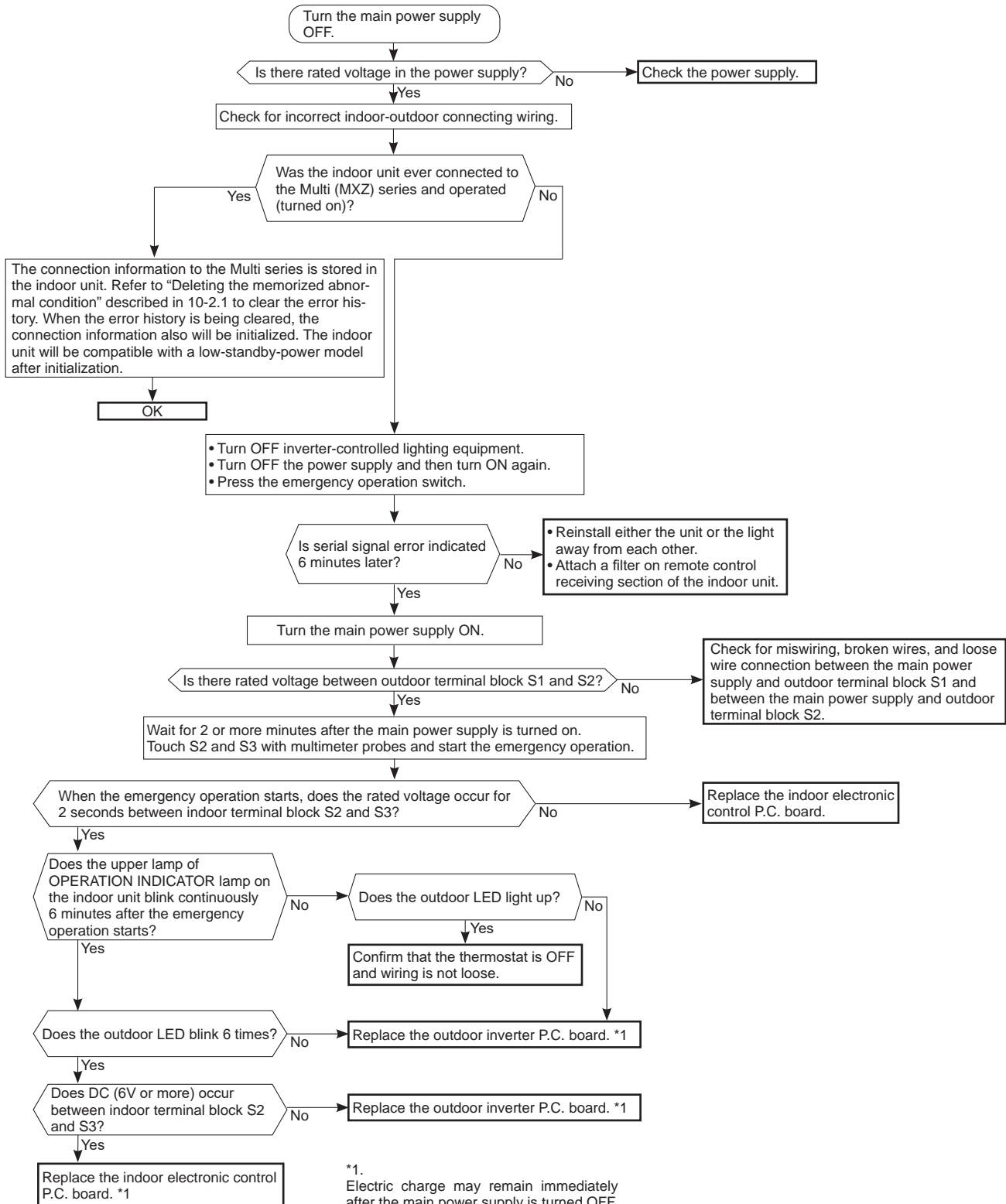

*1.
Electric charge may remain immediately after the main power supply is turned OFF. Perform the procedure after 3 minutes.

MXZ Type

LED indication for communication status

Communication status is indicated by the LED.

Unit status

Blinking: normal communication
Lit: abnormal communication or not connected

Pattern 1 and 2 is repeatedly displayed alternately. Each pattern is displayed for 10 seconds.

NOTE: "Lit" in the table below does not indicate abnormal communication.

Outdoor control P.C. board

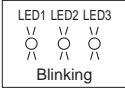

Pattern	LED 1	LED 2	LED 3
1	Unit A status	Unit B status	Lit
2	Unit C status	Unit D status	Not lit
3	Unit E status	—	Blinking

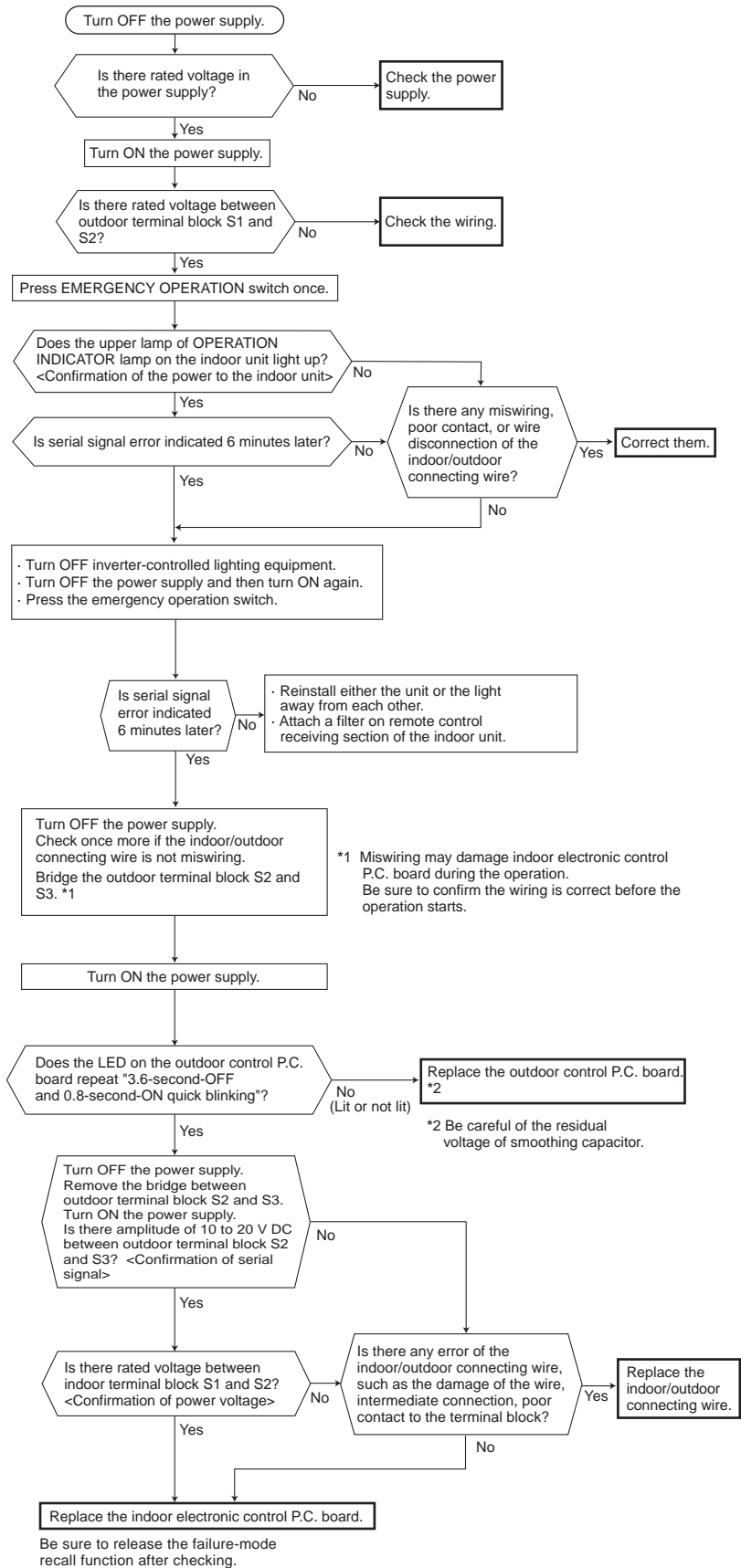

E Check of AIR PURIFYING power

After performing the check, make sure to release the failure mode recall function.

Turn ON the power supply.

High voltage (approximately 5.8kV) is generated during AIR PURIFYING power operation. Pay careful attention and never touch the air purifying device and the high-voltage lead part.

Does AIR PURIFYING lamp blink 2-time with unit stopping?

Yes

Replace the indoor electronic control P.C. board.

No

Make sure that the front panel is firmly closed.

- ① While pressing both Operation select button and TEMP button on the remote controller at the same time, press RESET button.
- ② First, release RESET button. Hold down the other two buttons for another 3 seconds. Make sure that the indicators on the LCD screen shown in the right figure are all displayed. Then release the buttons.
- ③ Press OFF/ON (stop/operate) button. (the set temperature is displayed) And press PURIFIER button once with the remote controller
- ④ headed towards the indoor unit.*1 AIR PURIFYING operation is selected. The AIR PURIFYING power operation check mode is set. (Refer to 10-2.5.)

MSZ-AY25/35/42/50VGKP

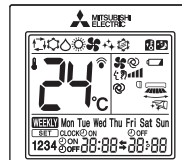
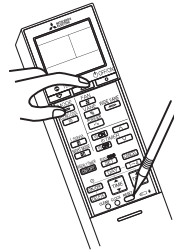

*1 Regardless of normal or abnormal condition, a short beep is emitted once the signal is received.

Does AIR PURIFYING lamp stay OFF, or continuously blink?

OFF

AIR PURIFYING power supply is normal. Working of the interlock switch (Air purifying device) due to uncomplete close of the front panel could cause 2-time blink.

Continuously blinking.

*2 Turn AIR PURIFYING power OFF and ON again. (For turning OFF AIR PURIFYING power, refer to 10-2.3.) (If it goes normal without turning OFF and ON, AIR PURIFYING lamp does not go OFF.)

Remove the air purifying device, firmly close the front panel, and then perform AIR PURIFYING power operation check (*2). Does AIR PURIFYING lamp stay OFF, or continuously blink?

OFF

Abnormal discharge may occur due to much dirt on the air purifying device, clean it. After cleaning, make sure to attach the air purifying device since it is completely dry. If AIR PURIFYING power operation check is performed with the air purifying device wet, protection gets active and AIR PURIFYING lamp blinks continuously as well.

Continuously blinking.

Turn OFF the power supply, and check the interlock switch (Air purifying device). Is it firmly fixed?

No

Firmly fix the interlock switch (Air purifying device).

Yes

Work and Not-work the interlock switch (Air purifying device) using something like a screw driver, and measure the resistance between CN1R1 ① and ② on the indoor electronic control P.C. board. Does the interlock switch (Air purifying device) function?

No

Replace the interlock switch (Air purifying device).

Yes

Keep the interlock switch (Air purifying device) Not-work (close) using something like a screw driver. Turn ON the power supply. Is the voltage between CN1T1 ① (+) and ② (GND) on the electronic control P.C. board) 0V with the unit stopping? (Refer to 10-7.)

No

12.5 V DC is generated.

Replace the indoor electronic control P.C. board.

Yes

Set the AIR PURIFYING power failure mode recall function. (Refer to 10-2.2)

When AIR PURIFYING power turns ON by pressing PURIFIER button once, is there 12.5 V DC between CN1T1 ① (+) and ② (GND)?

No

Replace the indoor electronic control P.C. board, after check of the wiring of CN1T1 on the indoor electronic control P.C. board.

Yes

Replace the air purifying device.

F Electromagnetic noise enters into TV sets or radios

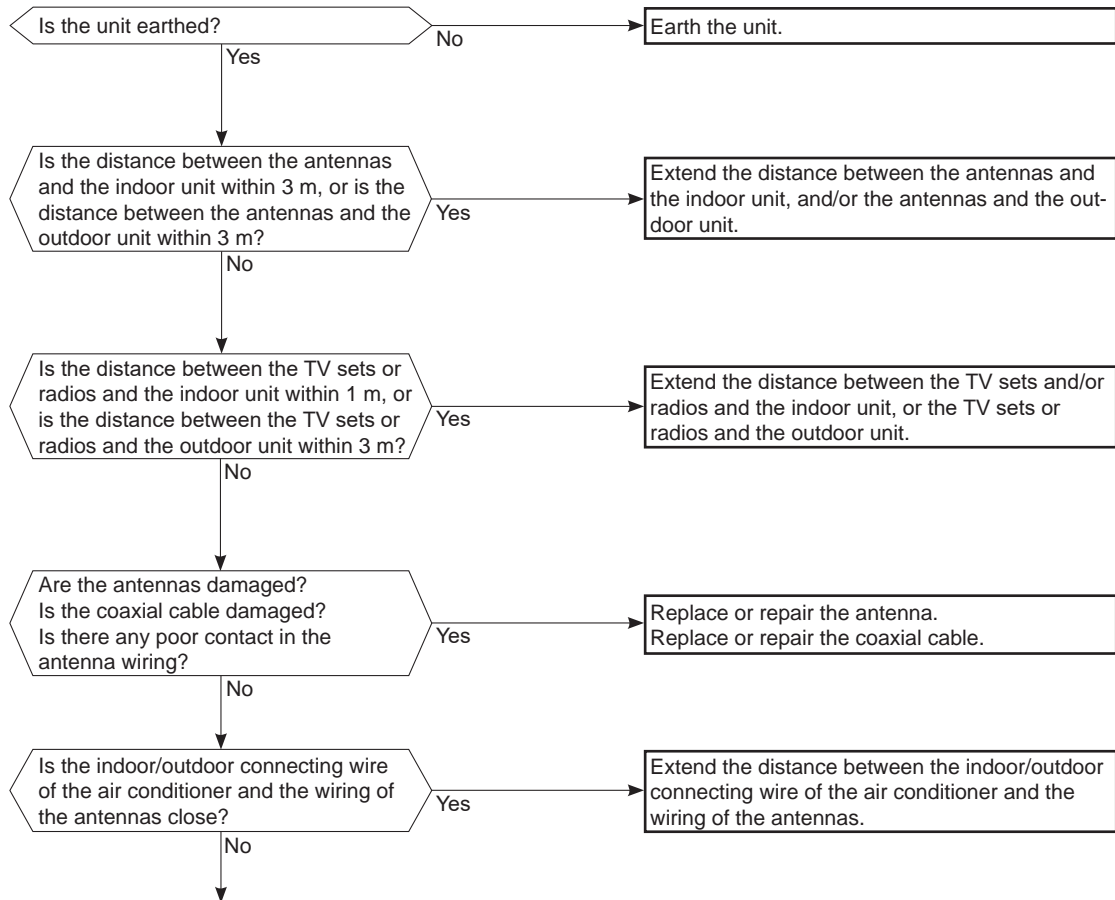

Even if all of the above conditions are fulfilled, the electromagnetic noise may enter, depending on the electric field strength or the installation condition (combination of specific conditions such as antennas or wiring).

Check the following before asking for service.

1. Devices affected by the electromagnetic noise
TV sets, radios (FM/AM broadcast, shortwave)
2. Channel, frequency, broadcast station affected by the electromagnetic noise
3. Channel, frequency, broadcast station unaffected by the electromagnetic noise
4. Layout of:
indoor/outdoor unit of the air conditioner, indoor/outdoor wiring, earth wire, antennas, wiring from antennas, receiver
5. Electric field intensity of the broadcast station affected by the electromagnetic noise
6. Presence or absence of amplifier such as booster
7. Operation condition of air conditioner when the electromagnetic noise enters in
 - 1) Turn OFF the power supply once, and then turn ON the power supply. In this situation, check for the electromagnetic noise.
 - 2) Within 3 minutes after turning ON the power supply, press OFF/ON (stop/operate) button on the remote controller for power ON, and check for the electromagnetic noise.
 - 3) After a short time (3 minutes later after turning ON), the outdoor unit starts running. During operation, check for the electromagnetic noise.
 - 4) Press OFF/ON (stop/operate) button on the remote controller for power OFF, when the outdoor unit stops but the indoor/outdoor communication still runs on. In this situation, check for the electromagnetic noise.

10-7. TEST POINT DIAGRAM AND VOLTAGE

Indoor terminal P.C. board, Indoor electronic control P.C. board, Receiver P.C. board, Display P.C. board, Switch/buzzer P.C. board

**MSZ-AY25VGK MSZ-AY35VGK MSZ-AY42VGK MSZ-AY50VGK
MSZ-AY25VGKP MSZ-AY35VGKP MSZ-AY42VGKP MSZ-AY50VGKP**

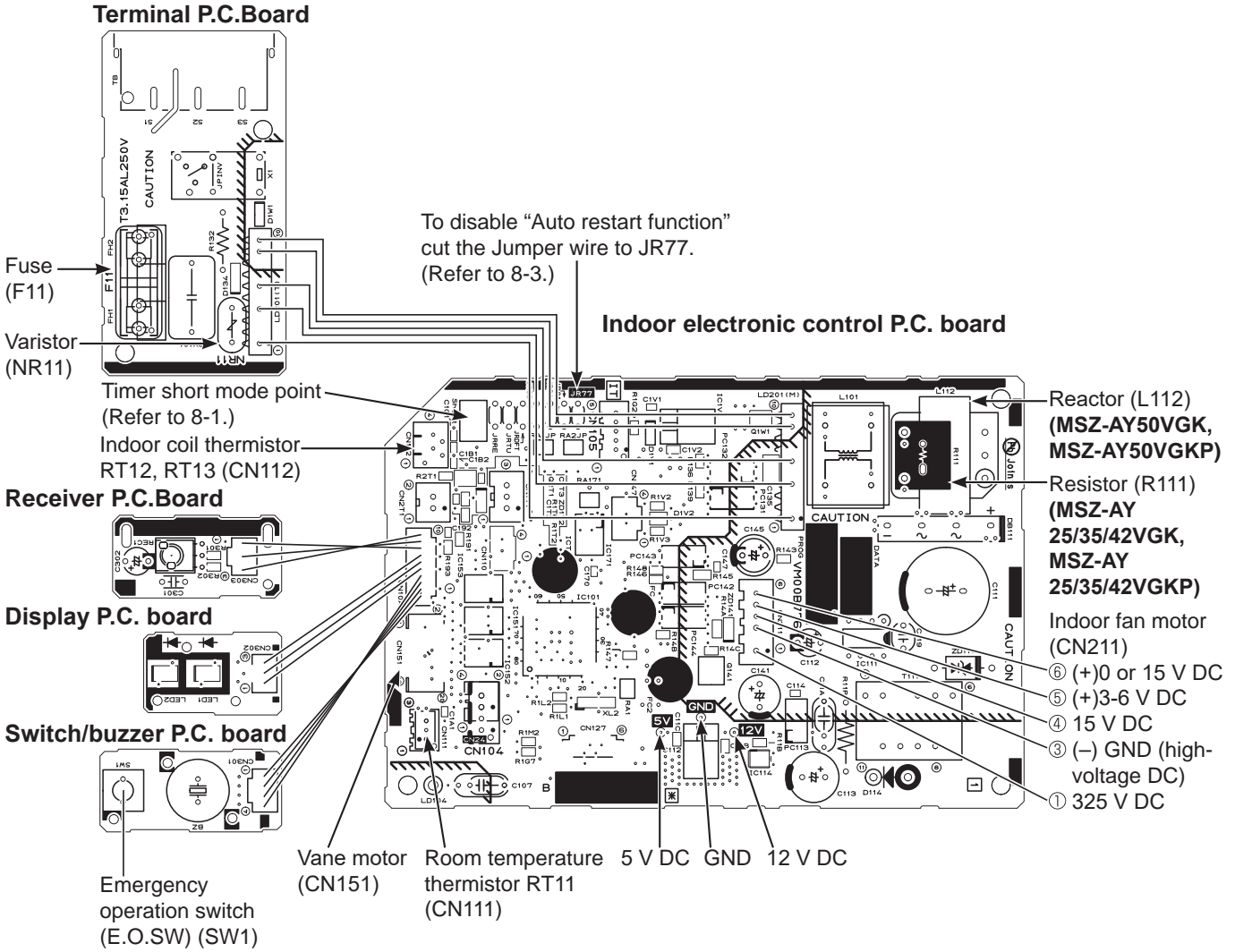

Room temperature thermistor (RT11)
Indoor coil thermistor (RT12, RT13)

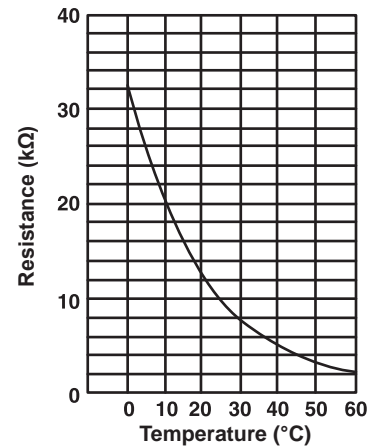

<Detaching method of the terminal with locking mechanism>

The terminal which has the locking mechanism can be detached as shown below.

There are 2 types of the terminal with locking mechanism.

The terminal without locking mechanism can be detached by pulling it out.

Check the shape of the terminal before detaching.

(1) Slide the sleeve and check if there is a locking lever or not.

(2) The terminal with this connector shown below has the locking mechanism.

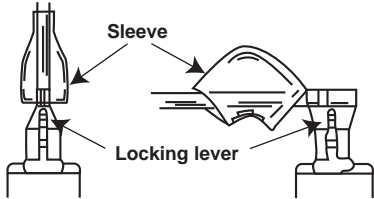

- ① Slide the sleeve.
- ② Pull the terminal while pushing the locking lever.

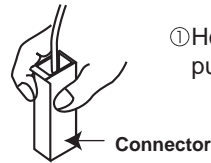



- ① Hold the sleeve, and pull out the terminal slowly.

**MSZ-AY25VGK MSZ-AY35VGK MSZ-AY42VGK MSZ-AY50VGK
MSZ-AY25VGKP MSZ-AY35VGKP MSZ-AY42VGKP MSZ-AY50VGKP**

—————>: Indicates the visible parts in the photos/figures.
- - - - ->: Indicates the invisible parts in the photos/figures.

NOTE: Turn OFF the power supply before disassembly.

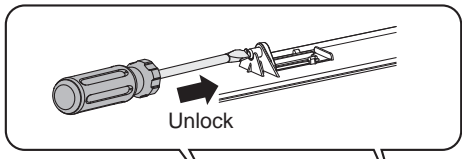
Photos: MSZ-AY42VGKP

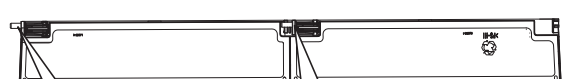
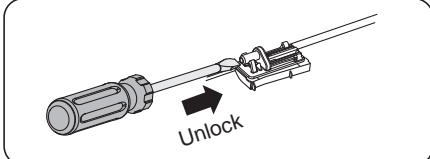
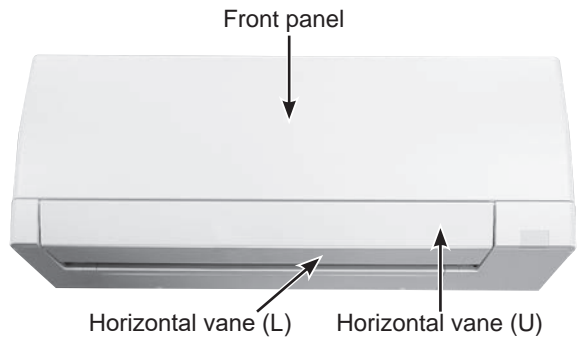
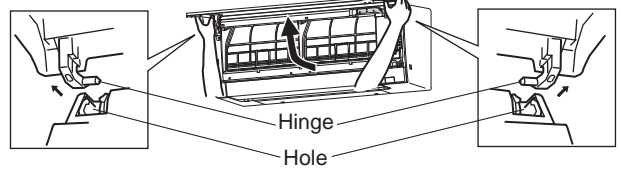
OPERATING PROCEDURE	PHOTOS/FIGURES
<p>1. Removing the front panel and the panels (R/L/F/U) Removing the front panel (Photo 1, Figure 1) (1) Lift the front panel until a "click" is heard. (2) Hold the hinges and pull to remove the front panel (Figure 1). (3) Remove the horizontal vanes.</p> <div style="border: 1px solid black; padding: 5px; margin: 10px 0;"> <p>Unlock the stopper and remove the horizontal vanes using following tool like a screw driver.</p>  <p style="text-align: center;">Unlock</p>  <p style="text-align: right;">Upper</p>  <p style="text-align: right;">Lower</p>  <p style="text-align: center;">Unlock</p> </div>	<p>Photo 1</p>  <p style="text-align: center;">Front panel</p> <p style="text-align: center;">Horizontal vane (L) Horizontal vane (U)</p> <p>Figure 1</p>  <p style="text-align: center;">Hinge Hole</p>

OPERATING PROCEDURE

Removing the panel (R) (Photos 1, 2, Figure 1)

- (1) Remove the front panel and the horizontal vanes (U) (L).
- (2) Remove the screw cap on the panel (R), and the screw.
- (3) Remove the 2 screws of the panel (R), and pull the top of the panel (R) toward you to remove.

Removing the panel (L) (Photos 1, 2, Figure 1)

- (1) Remove the front panel and the horizontal vanes (U) (L).
- (2) Remove the screw cap on the panel (L), and the screw.
- (3) Remove the screw of the panel (L), and pull the top of the panel (L) toward you to remove.

Removing the panel (F) (Photos 1, 2, 3 Figure 1)

- (1) Remove the front panel and the horizontal vanes (U) (L).
- (2) Remove the panels (R) (L).
- (3) Remove the Wi-Fi interface on the right side of the panel (F). Pull out its cable, and remove the cable tie (Refer to section 2).
- (4) Remove the panel (F) from the bottom to the top.

Removing the panel (U) (Photo 2, Figure 1)

- (1) Remove the front panel and the horizontal vanes (U) (L).
- (2) Remove the panels (R) (L).
- (3) Remove the center hook of the panel (U), and pull it toward you to remove.

PHOTOS/FIGURES

Photo 2

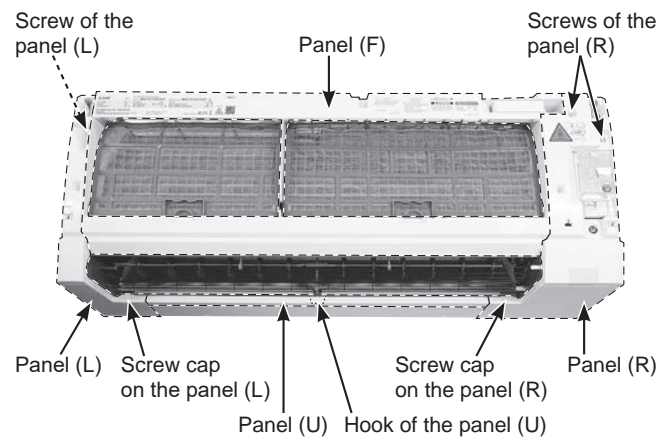

OPERATING PROCEDURE

2. Removing the Wi-Fi interface (Photos 3, 5)

- (1) Remove the front panel and the horizontal vanes (U) (L).
- (2) Remove the panels (R) (L) (U).
- (3) Remove the screw of the V.A. clamp and remove the V.A. clamp.
- (4) Remove the Wi-Fi interface on the right side of the panel (F). Pull out its cable, and remove the cable tie, then remove the panel (F).
- (5) Unhook the catch on the left side of the display and receiver P.C. board holder. Pull the display and receiver P.C. board holder as if opening the door at 90 degrees.
- (6) Remove the screw of the electrical cover, and remove the electrical cover.
- (7) Disconnect the following connector (Photo 5):
<Indoor electronic control P.C. board>
CN110 (Wi-Fi interface)
- (8) Remove the lead wire of the Wi-Fi interface from the hook of the cable guide.

How to install the Wi-Fi interface (Photo 3)

Note: Install the Wi-Fi interface before installing the panel (R).

- (1) Install the panel (F).
- (2) Fasten the cable of Wi-Fi interface to the part ① of the panel (F) with a cable tie.
- (3) Stow the cable of Wi-Fi interface in the area ②.
- (4) Attach the Wi-Fi interface so that its cable is facing away from you on the right side.
- (5) Attach the lead wire of the Wi-Fi interface to the hook of the cable guide.
- (6) Close the display and receiver P.C. board holder through the lead wire under the display and receiver P.C. board holder.
- (7) Connect the connector of Wi-Fi interface (CN110) to the indoor electronic control P.C. board.
- (8) Install the electrical cover, and install the screw in the electrical cover.
- (9) Install the V.A. clamp, and install the screw in the V.A. clamp.
- (10) Install the panel (U).
- (11) Install the panel (R).
- (12) Install the panel (L).

PHOTOS/FIGURES

Photo 3

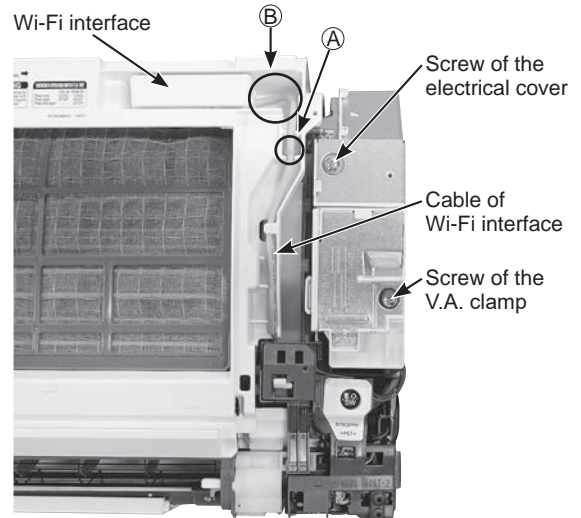

OPERATING PROCEDURE

3. Removing the indoor electrical box and the air purifying device (Photos 3, 4, 5, 6)

- (1) Remove the front panel and the horizontal vanes (U) (L).
- (2) Remove the panel (R) and the Wi-Fi interface from the panel (F).
- (3) Remove the panels (L) (U) (F).
- (4) Remove the lead wires of indoor coil thermistor and the air purifying device from the water cover.
- (4) Remove the earth wire connected to the indoor heat exchanger from the electrical box.
- (5) Disconnect the following connector (Photo 5):
<Indoor electronic control P.C. board>
CN110 (Wi-Fi interface)
CN151 (Vane motors)
CN211 (Indoor fan motor)
CN112 (Indoor coil thermistors)
CN1T1, CN2T1 (Air purifying device) **(MSZ-AY-VGKP)**
- (6) Remove the electrical box.
- (7) Remove the screw of the air purifying device and the air purifying device (Photo 6). **(MSZ-AY-VGKP)**

4. Removing the indoor terminal P.C. board, the switch board, the display board, the receiver board and the indoor electronic control P.C. board

- (1) Remove the indoor electrical box (Refer to section 3).
- (2) Remove the screw of the terminal block (Photo 5).
- (3) Remove the earth wire connected to the electrical box from the indoor electronic control P.C. board.
- (4) Remove the indoor terminal P.C. board.
- (5) Pull the display and receiver P.C. board holder as if opening the door at 90 degrees. Remove the display and receiver P.C. board holder from the axial rod on the electrical box.
- (6) Open the rear cover of the display and receiver P.C. board holder.
- (7) Remove the switch/ buzzer P.C. board, the display P.C. board and the receiver P.C. board.
- (8) Remove the indoor electronic control P.C. board.

PHOTOS/FIGURES

Photo 4

Lead wire of the indoor coil thermistor and air purifying device **(MSZ-AY-VGKP)**

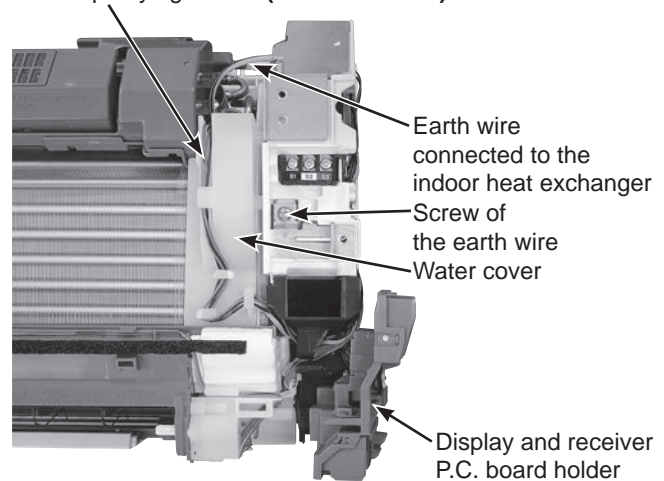

Photo 5

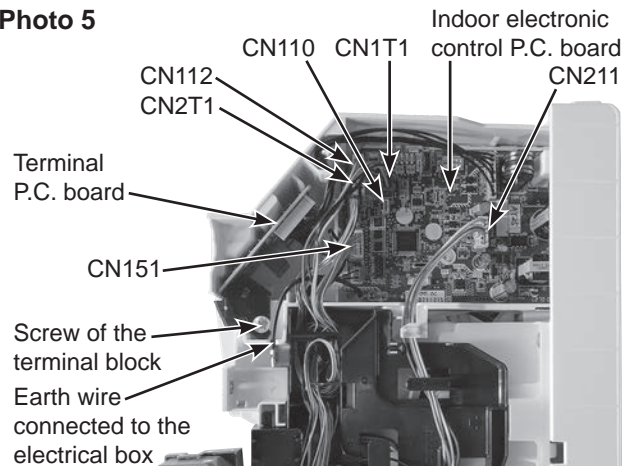
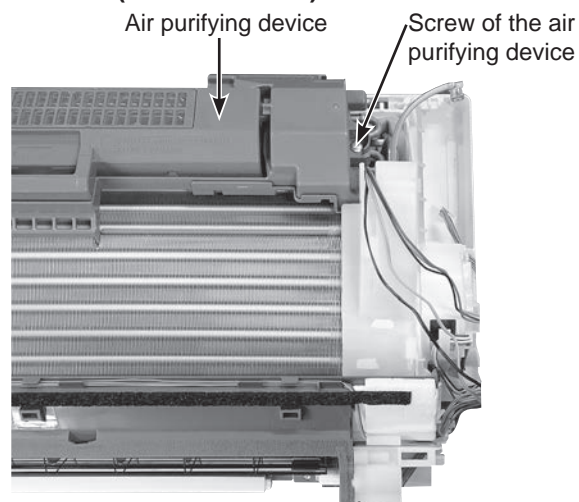

Photo 6 (MSZ-AY-VGKP)



OPERATING PROCEDURE

5. Removing the nozzle assembly

- (1) Remove the front panel and the horizontal vanes (U) (L).
- (2) Remove the panels (R) (L) (U) (F).
- (3) Remove the indoor/outdoor connecting wire (Refer to section 3).
- (4) Remove the electrical cover (Refer to section 3).
- (5) Disconnect the following connector:
<Indoor electronic control P.C. board>
CN151 (Vane motors)
- (6) Unhook the catch on the left side of the display and receiver P.C. board holder. Pull the display and receiver P.C. board holder as if opening the door at 90 degrees. Remove the display and receiver P.C. board holder from the axial rod on the electrical box.
- (7) Pull out the drain hose from the nozzle assembly and remove the nozzle assembly.
- (8) Remove the vane motors (Refer to section 6).

6. Removing the vane motors (U) (L) (horizontal) and the vane motor (vertical)

- (1) Remove the front panel, the horizontal vanes (U) (L), the panels (R) (L) (F) (U), the Wi-Fi interface, the V.A. clamp, and the electrical cover.
- (2) Unhook the catch on the left side of the display and receiver P.C. board holder. Pull the display and receiver P.C. board holder as if opening the door at 90 degrees.
- (3) Remove the following connector (Photo 5):
<Indoor electronic control P.C. board>
CN151 (Vane motors)
- (4) Pull out the drain hose from the nozzle assembly. Pull and remove the nozzle assembly (refer to section 5).

Removing the vane motors (U) (L) (horizontal) (Photo 7)

- (5) Remove the 2 screws of the vane motor unit (U) (L) and remove the lead wires of the vane motors (U) (L) (horizontal).
- (6) Remove the screw of the vane motor unit (L) (horizontal), and remove the vane motor unit (L) (horizontal).
- (7) Remove the 2 screws of the vane motor unit (U) (horizontal) from the backside of the vane motor unit (U) (L) (horizontal), and remove the vane motor unit (L) (horizontal).

Removing the vane motor unit (vertical) (Photo 8, 9)

- (8) Remove the crank of the vane motor unit (vertical) from the vane (vertical).
- (9) Remove the 2 screws of the vane motor unit (vertical), and pull the vane motor unit (vertical).
- (10) Remove the 2 screws of the vane motor unit cover (vertical).
- (11) Remove the crank of the vane motor unit (vertical) from the shaft of the vane motor (vertical).
- (12) Remove the vane motor (vertical) from the vane motor unit (vertical).
- (13) Disconnect the connector of vane motor (vertical) from the vane motor (vertical).

PHOTOS/FIGURES

Photo 7

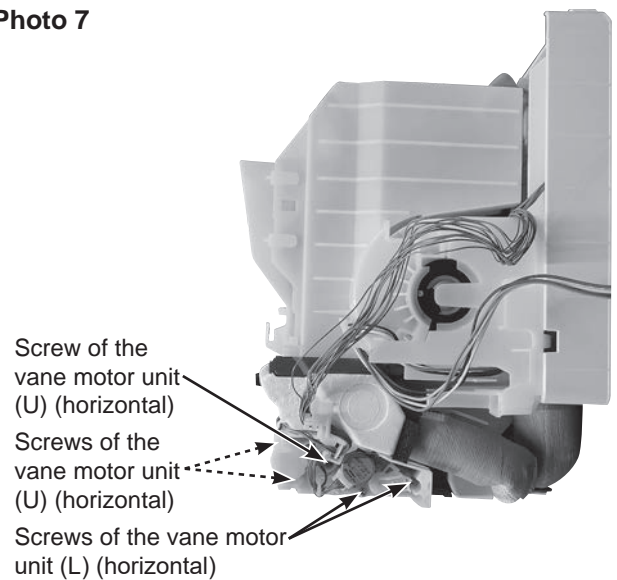

Photo 8

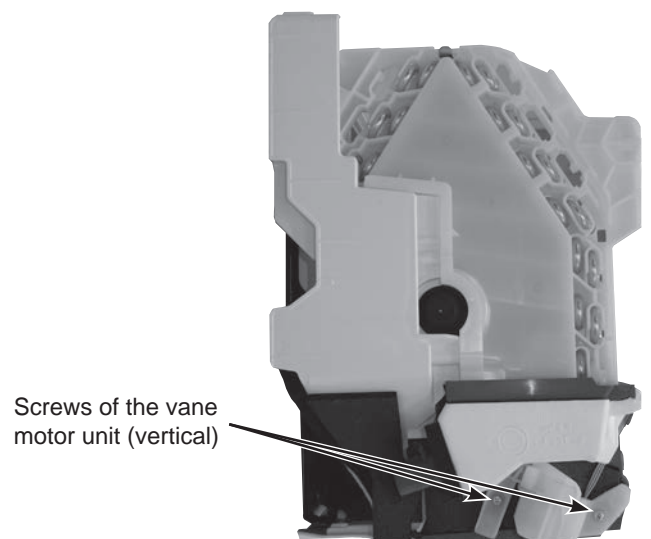
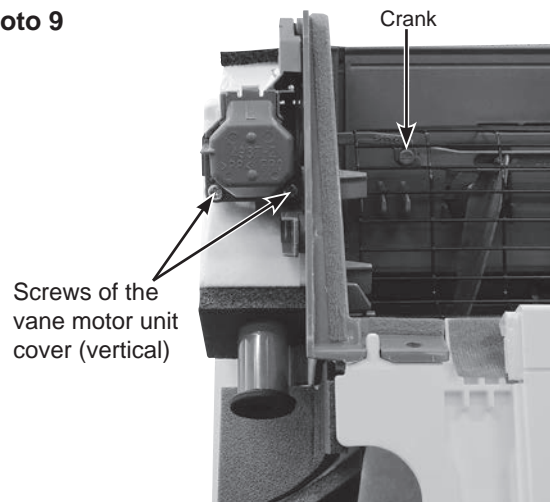

Photo 9



OPERATING PROCEDURE

7. Removing the line flow fan, the indoor fan motor assembly, the indoor coil thermistor (Photo 10, 11, 12)

- (1) Remove the front panel, the horizontal vanes (U) (L), the panels (R) (L) (F) (U), the Wi-Fi interface, the electrical box, and the nozzle assembly.
- (2) Disengage the catches of the water cover, and remove the water cover.
- (3) Loosen the screw inside the right side of the line flow fan (Photo 10).
- (4) Remove the 3 screws of the fan motor assembly. Pull the fan motor assembly slightly toward you, and remove it by pulling to the right (Photo 11).
- (5) Remove the indoor coil thermistor from the heat exchanger.
- (6) Remove the 2 screws of the hairpin holder on the left side of the heat exchanger. Raise the left side of the heat exchanger, and pull the line flow fan to the lower left to remove (Photo 12).

*1 When attaching the line flow fan, screw the line flow fan so 4 mm gap is provided between the right end of the line flow fan and the right wall of the air passage of the box (Figure 2).

Figure 2

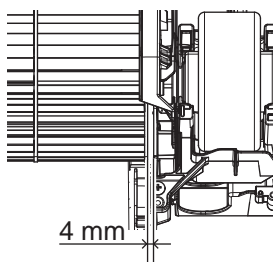

PHOTOS/FIGURES

Photo 10

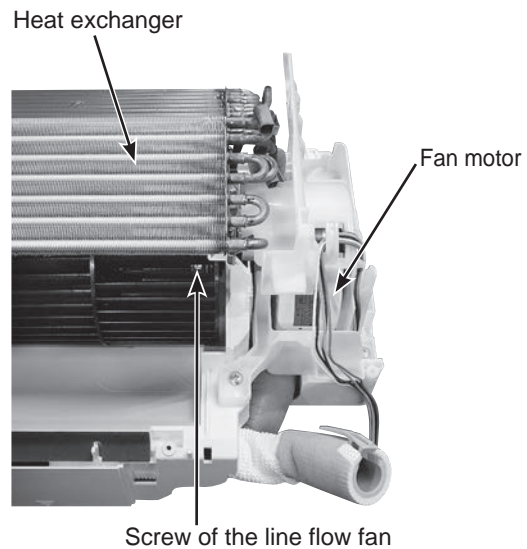

Photo 11

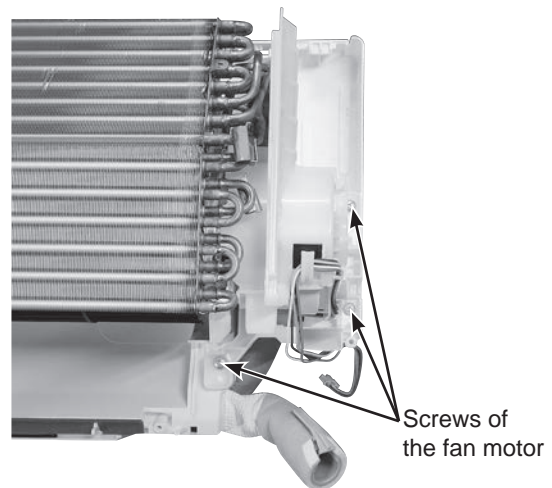
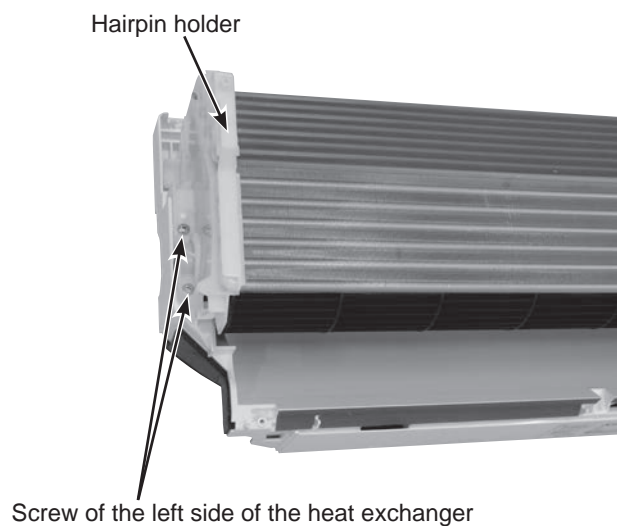

Photo 12



Fixing the indoor coil thermistor

* There are 2 forms of parts for fixing the indoor coil thermistor.

Clip shape



Holder shape



When fixing the indoor coil thermistor to the clip-shape/holder-shape part, the lead wire should point down.

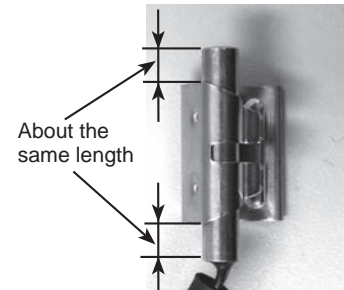

Position and procedure for mounting the clip-shape part

1. Set the indoor coil thermistor in the center of the clip-shape part.



2. Check the (marked) mounting position.



3. Mount the clip-shape part.



NOTE:

- Take care to avoid loss and accidental falling of the clip-shape part inside the unit.
- Mount the clip-shape part on the marked position.
- Do not pull the lead wire when removing the indoor coil thermistor.

mitsubishi electric corporation

HEAD OFFICE: TOKYO BUILDING, 2-7-3, MARUNOUCHI, CHIYODA-KU, TOKYO 100-8310, JAPAN

© Copyright 2022 MITSUBISHI ELECTRIC CORPORATION
Published: Nov. 2022. No. OBH930
Made in Japan

Specifications are subject to change without notice.