

TECHNICAL & SERVICE MANUAL

REVISED EDITION-C

[Model Name]	[Service Ref.]
SUZ-M25VA	SUZ-M25VA.TH SUZ-M25VAR1.TH SUZ-M25VAR2.TH
SUZ-M25VA-ET	SUZ-M25VA-ET.TH SUZ-M25VA-ETR2.TH
SUZ-M35VA	SUZ-M35VA.TH SUZ-M35VAR1.TH SUZ-M35VAR2.TH
SUZ-M35VA-ET	SUZ-M35VA-ET.TH SUZ-M35VA-ETR2.TH
SUZ-M50VA	SUZ-M50VA.TH SUZ-M50VAR1.TH SUZ-M50VAR2.TH
SUZ-M50VA-ET	SUZ-M50VA-ET.TH SUZ-M50VA-ETR2.TH
SUZ-M60VA	SUZ-M60VA.TH SUZ-M60VAR1.TH SUZ-M60VAR2.TH
SUZ-M60VA-ET	SUZ-M60VA-ET.TH SUZ-M60VA-ETR2.TH
SUZ-M71VA	SUZ-M71VA.TH SUZ-M71VAR1.TH
SUZ-M71VA-ET	SUZ-M71VA-ET.TH SUZ-M71VA-ETR1.TH

R32
Revision:

- SUZ-M25VAR2.TH, SUZ-M35VAR2.TH, SUZ-M50VAR2.TH, SUZ-M60VAR2.TH, SUZ-M71VAR1.TH, SUZ-M25VA-ETR2.TH, SUZ-M35VA-ETR2.TH, SUZ-M50VA-ETR2.TH, SUZ-M60VA-ETR2.TH, and SUZ-M71VA-ETR1.TH have been added in REVISED EDITION-C.

OCH684 REVISED EDITION-B is void.

Note:

- This service manual describes service data of the outdoor units only.

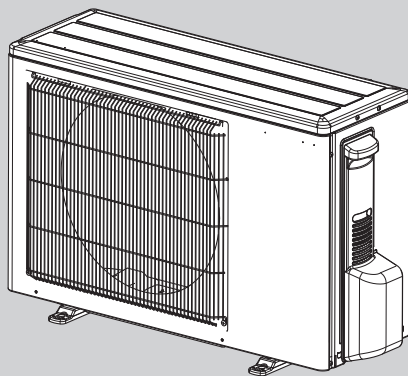
 SUZ-M25VA.TH
SUZ-M35VA.TH

CONTENTS

TECHNICAL CHANGES.....	2
1. COMBINATION OF INDOOR AND OUTDOOR UNITS	2
2. SAFETY PRECAUTION	3
3. PARTS NAMES AND FUNCTIONS	11
4. SPECIFICATION.....	12
5. NOISE CRITERIA CURVES	14
6. OUTLINES AND DIMENSIONS	15
7. WIRING DIAGRAM.....	17
8. REFRIGERANT SYSTEM DIAGRAM	21
9. ACTUATOR CONTROL.....	24
10. SERVICE FUNCTIONS.....	25
11. TROUBLESHOOTING	25
12. DISASSEMBLY PROCEDURE.....	42

PARTS CATALOG (OCB684)

TECHNICAL CHANGES

Service ref. have been changed as follows.

SUZ-M25VAR1.TH	➔	SUZ-M25VAR2.TH
SUZ-M35VAR1.TH	➔	SUZ-M35VAR2.TH
SUZ-M50VAR1.TH	➔	SUZ-M50VAR2.TH
SUZ-M60VAR1.TH	➔	SUZ-M60VAR2.TH
SUZ-M71VA.TH	➔	SUZ-M71VAR1.TH
SUZ-M25VA-ET.TH	➔	SUZ-M25VA-ETR2.TH
SUZ-M35VA-ET.TH	➔	SUZ-M35VA-ETR2.TH
SUZ-M50VA-ET.TH	➔	SUZ-M50VA-ETR2.TH
SUZ-M60VA-ET.TH	➔	SUZ-M60VA-ETR2.TH
SUZ-M71VA-ET.TH	➔	SUZ-M71VA-ETR1.TH

• Connection with SFZ will be added.

SUZ-M25VA.TH	➔	SUZ-M25VAR1.TH
SUZ-M35VA.TH	➔	SUZ-M35VAR1.TH
SUZ-M50VA.TH	➔	SUZ-M50VAR1.TH
SUZ-M60VA.TH	➔	SUZ-M60VAR1.TH

• Connection with MFZ-KT will be added.

1 COMBINATION OF INDOOR AND OUTDOOR UNITS





INDOOR UNIT SERVICE MANUAL

Indoor unit		Outdoor unit				
		Heat pump type				
Service Ref.	Service manual No.	SUZ-				
		M25VA.TH M25VAR1.TH M25VAR2.TH M25VA-ET.TH M25VA-ETR2.TH	M35VA.TH M35VAR1.TH M35VAR2.TH M35VA-ET.TH M35VA-ETR2.TH	M50VA.TH M50VAR1.TH M50VAR2.TH M50VA-ET.TH M50VA-ETR2.TH	M60VA.TH M60VAR1.TH M60VAR2.TH M60VA-ET.TH M60VA-ETR2.TH	M71VA.TH M71VAR1.TH M71VA-ET.TH M71VA-ETR1.TH
SLZ-M25FA.TH	OCH522 OCB522	○	—	—	—	—
SLZ-M35FA.TH		—	○	—	—	—
SLZ-M50FA.TH		—	—	○	—	—
SLZ-M60FA.TH	HWE17040 BWE017250	—	—	—	○	—
SEZ-M25DA.TH		○	—	—	—	—
SEZ-M35DA.TH		—	○	—	—	—
SEZ-M50DA.TH		—	—	○	—	—
SEZ-M60DA.TH		—	—	—	○	—
SEZ-M71DA.TH	—	—	—	—	○	
MLZ-KP25VF-E1	OBH801 OBB801	○	—	—	—	—
MLZ-KP35VF-E1		—	○	—	—	—
MLZ-KP50VF-E1		—	—	○	—	—
MFZ-KT25VG-E1	—	○*1	—	—	—	—
MFZ-KT35VG-E1		—	○*1	—	—	—
MFZ-KT50VG-E1		—	—	○*1	—	—
MFZ-KT60VG-E1		—	—	—	○*1	—
PLA-M35EA.UK	OCH697 OCB697	—	○	—	—	—
PLA-M50EA.UK		—	—	○	—	—
PLA-M60EA.UK		—	—	—	○	—
PLA-M71EA.UK		—	—	—	—	○
PCA-M35KA	OCH659 OCB659	—	○	—	—	—
PCA-M50KA		—	—	○	—	—
PCA-M60KA		—	—	—	○	—
PCA-M71KA		—	—	—	—	○
PEAD-M35JA(L).UK	HWE16130 BWE017010	—	○	—	—	—
PEAD-M50JA(L).UK		—	—	○	—	—
PEAD-M60JA(L).UK		—	—	—	○	—
PEAD-M71JA(L).UK		—	—	—	—	○
SFZ-M25VA	—	○*2	—	—	—	—
SFZ-M35VA		—	○*2	—	—	—
SFZ-M50VA		—	—	○*2	—	—
SFZ-M60VA		—	—	—	○*2	—
SFZ-M71VA		—	—	—	—	○*2

*1 Only for R1 and R2 models.

*2 Only for R2 models.

MEANINGS OF SYMBOLS DISPLAYED ON THE UNIT

	WARNING (Risk of fire)	This mark is for R32 refrigerant only. Refrigerant type is written on nameplate of outdoor unit. In case that refrigerant type is R32, this unit uses a flammable refrigerant. If refrigerant leaks and comes in contact with fire or heating part, it will create harmful gas and there is risk of fire.
	Read the OPERATION MANUAL carefully before operation.	
	Service personnel are required to carefully read the OPERATION MANUAL and INSTALLATION MANUAL before operation.	
	Further information is available in the OPERATION MANUAL, INSTALLATION MANUAL, and the like.	

2-1. ALWAYS OBSERVE FOR SAFETY

Before obtaining access to terminal, all supply circuits must be disconnected.

2-2. CAUTIONS RELATED TO NEW REFRIGERANT

Cautions for units utilizing refrigerant R32

Preparation before the repair service

- Prepare the proper tools.
- Prepare the proper protectors.
- Provide adequate ventilation.
- After stopping the operation of the air conditioner, turn off the power-supply breaker.
- Discharge the condenser before the work involving the electric parts.

Use new refrigerant pipes.

In the case of using the existing pipes for R22, be careful with the following.

- Be sure to clean the pipes and make sure that the insides of the pipes are clean.
- Change flare nut to the one provided with this product. Use a newly flared pipe.
- Avoid using thin pipes.

Make sure that the inside and outside of refrigerant piping is clean and it has no contaminants such as sulfur, oxides, dirt, shaving particles, etc., which are hazard to refrigerant cycle.

In addition, use pipes with specified thickness.

Contamination inside refrigerant piping can cause deterioration of refrigerant oil, etc.

Store the piping indoors, and keep both ends of the piping sealed until just before brazing. (Leave elbow joints, etc. in their packaging.)

If dirt, dust or moisture enters into refrigerant cycle, that can cause deterioration of refrigerant oil or malfunction of compressor.

The refrigerant oil applied to flare and flange connections must be ester oil, ether oil or alkylbenzene oil in a small amount.

If large amount of mineral oil enters, that can cause deterioration of refrigerant oil, etc.

Do not use refrigerant other than R32.

If other refrigerant (R22, etc.) is used, chlorine in refrigerant can cause deterioration of refrigerant oil, etc.

Precautions during the repair service

- Do not perform the work involving the electric parts with wet hands.
- Do not pour water into the electric parts.
- Do not touch the refrigerant.
- Do not touch the hot or cold areas in the refrigerating cycle.
- When the repair or the inspection of the circuit needs to be done without turning off the power, exercise great caution not to touch the live parts.

Use a vacuum pump with a reverse flow check valve.

Vacuum pump oil may flow back into refrigerant cycle and that can cause deterioration of refrigerant oil, etc.

Use the following tools specifically designed for use with R32 refrigerant.

The following tools are necessary to use R32 refrigerant.

Tools for R32	
Gauge manifold	Flare tool
Charge hose	Size adjustment gauge
Gas leak detector	Vacuum pump adaptor
Torque wrench	Electronic refrigerant charging scale

Handle tools with care.

If dirt, dust or moisture enters into refrigerant cycle, that can cause deterioration of refrigerant oil or malfunction of compressor.

Use the specified refrigerant only.

Never use any refrigerant other than that specified. Doing so may cause a burst, an explosion, or fire when the unit is being used, serviced, or disposed of. Correct refrigerant is specified in the manuals and on the spec labels provided with our products. We will not be held responsible for mechanical failure, system malfunction, unit breakdown or accidents caused by failure to follow the instructions.

Ventilate the room if refrigerant leaks during operation. If refrigerant comes into contact with a flame, poisonous gases will be released.

[1] Warning for service

- (1) Do not alter the unit.
- (2) For installation and relocation work, follow the instructions in the Installation Manual and use tools and pipe components specifically made for use with refrigerant specified in the outdoor unit installation manual.
- (3) Ask a dealer or an authorized technician to install, relocate and repair the unit.
For appliances not accessible to the general public.
- (4) Refrigerant pipes connection shall be accessible for maintenance purposes.
- (5) If the air conditioner is installed in a small room or closed room, measures must be taken to prevent the refrigerant concentration in the room from exceeding the safety limit in the event of refrigerant leakage. Should the refrigerant leak and cause the concentration limit to be exceeded, hazards due to lack of oxygen in the room may result.
- (6) Keep gas-burning appliances, electric heaters, and other fire sources (ignition sources) away from the location where installation, repair, and other air conditioner work will be performed.
If refrigerant comes into contact with a flame, poisonous gases will be released.
- (7) When installing or relocating, or servicing the air conditioner, use only the specified refrigerant (R32) to charge the refrigerant lines.
Do not mix it with any other refrigerant and do not allow air to remain in the lines.
If air is mixed with the refrigerant, then it can be the cause of abnormal high pressure in the refrigerant line, and may result in an explosion and other hazards.
- (8) After installation has been completed, check for refrigerant leaks. If refrigerant leaks into the room and comes into contact with the flame of a heater or portable cooking range, poisonous gases will be released.
- (9) Do not use low temperature solder alloy in the case of brazing the refrigerant pipes.
- (10) When performing brazing work, be sure to ventilate the room sufficiently. Make sure that there are no hazardous or flammable materials nearby.
When performing the work in a closed room, small room, or similar location, make sure that there are no refrigerant leaks before performing the work.
If refrigerant leaks and accumulates, it may ignite or poisonous gases may be released.
- (11) Do not install the unit in places where refrigerant may build-up or places with poor ventilation such as a semi-basement or a sunken place in outdoor: Refrigerant is heavier than air, and inclined to fall away from the leak source.
- (12) Do not use means to accelerate the defrosting process or to clean, other than those recommended by the manufacturer.
- (13) The appliance shall be stored in a room without continuously operating ignition sources (for example: open flames, an operating gas appliance or an operating electric heater).
- (14) Do not pierce or burn.
- (15) Be aware that refrigerants may not contain an odor.
- (16) Pipe-work shall be protected from physical damage.
- (17) The installation of pipe-work shall be kept to a minimum.
- (18) Compliance with national gas regulations shall be observed.
- (19) Keep any required ventilation openings clear of obstruction.
- (20) Servicing shall be performed only as recommended by the manufacturer.
- (21) The appliance shall be stored in a well-ventilated area where the room size corresponds to the room area as specified for operation.
- (22) Maintenance, service and repair operations shall be performed by authorized technician with required qualification.
- (23) Be sure to have appropriate ventilation in order to prevent ignition. Furthermore, be sure to carry out fire prevention measures that there are no dangerous or flammable objects in the surrounding area.

[2] Cautions for unit using R32 refrigerant

Basic work procedures are the same as those for conventional units using refrigerant R410A. However, pay careful attention to the following points.

(1) Information on servicing

(1-1) Checks on the Area

Prior to beginning work on systems containing flammable refrigerants, safety checks are necessary to ensure that the risk of ignition is minimized.

For repair to the refrigerating systems, (1-3) to (1-7) shall be completed prior to conducting work on the systems.

(1-2) Work Procedure

Work shall be undertaken under a controlled procedure so as to minimize the risk of a flammable gas or vapor being present while the work is being performed.

(1-3) General Work Area

All maintenance staff and others working in the local area shall be instructed on the nature of work being carried out.

Work in confined spaces shall be avoided. The area around the workspace shall be sectioned off. Ensure that the conditions within the area have been made safe by control of flammable material.

(1-4) Checking for Presence of Refrigerant

The area shall be checked with an appropriate refrigerant detector prior to and during work, to ensure the technician is aware of potentially toxic or flammable atmospheres. Ensure that the leak detection equipment being used is suitable for use with all applicable refrigerants, i.e. non-sparking, adequately sealed or intrinsically safe.

(1-5) Presence of Fire Extinguisher

If any hot work is to be conducted on the refrigeration equipment or any associated parts, appropriate fire extinguishing equipment shall be available to hand.

Have a dry powder or CO₂ fire extinguisher adjacent to the charging area.

(1-6) No Ignition Sources

No person carrying out work in relation to a refrigeration system which involves exposing any pipe work shall use any sources of ignition in such a manner that it may lead to the risk of fire or explosion. All possible ignition sources, including cigarette smoking, should be kept sufficiently far away from the site of installation, repairing, removing and disposal, during which refrigerant can possibly be released to the surrounding space. Prior to work taking place, the area around the equipment is to be surveyed to make sure that there are no flammable hazards or ignition risks. "No Smoking" signs shall be displayed.

(1-7) Ventilated Area

Ensure that the area is in the open or that it is adequately ventilated before breaking into the system or conducting any hot work. A degree of ventilation shall continue during the period that the work is carried out. The ventilation should safely disperse any released refrigerant and preferably expel it externally into the atmosphere.

(1-8) Checks on the Refrigeration Equipment

Where electrical components are being changed, they shall be fit for the purpose and to the correct specification. At all times the manufacturer's maintenance and service guidelines shall be followed. If in doubt, consult the manufacturer's technical department for assistance.

The following checks shall be applied to installations using flammable refrigerants:

- The charge size is in accordance with the room size within which the refrigerant containing parts are installed.
- The ventilation machinery and outlets are operating adequately and are not obstructed.
- Marking to the equipment continues to be visible and legible. Markings and signs that are illegible shall be corrected.
- Refrigeration pipe or components are installed in a position where they are unlikely to be exposed to any substance which may corrode refrigerant containing components, unless the components are constructed of materials which are inherently resistant to being corroded or are suitably protected against being corroded.

(1-9) Checks on Electrical Devices

Repair and maintenance to electrical components shall include initial safety checks and component inspection procedures. If a fault exists that could compromise safety, then no electrical supply shall be connected to the circuit until it is satisfactorily dealt with. If the fault cannot be corrected immediately but it is necessary to continue operation, an adequate temporary solution shall be used. This shall be reported to the owner of the equipment so all parties are advised. Initial safety checks shall include that:

- capacitors are discharged: this shall be done in a safe manner to avoid possibility of sparking;
- no live electrical components and wiring are exposed while charging, recovering or purging the system;
- there is continuity of earth bonding

(2) Repairs to Sealed Components

(2-1) During repairs to sealed components, all electrical supplies shall be disconnected from the equipment being worked upon prior to any removal of sealed covers, etc. If it is absolutely necessary to have an electrical supply to equipment during servicing, then a permanently operating form of leak detection shall be located at the most critical point to warn of a potentially hazardous situation.

(2-2) Particular attention shall be paid to the following to ensure that by working on electrical components, the casing is not altered in such a way that the level of protection is affected. This shall include damage to cables, excessive number of connections, terminals not made to original specification, damage to seals, incorrect fitting of glands, etc.

Ensure that the apparatus is mounted securely.

Ensure that seals or sealing materials have not degraded to the point that they no longer serve the purpose of preventing the ingress of flammable atmospheres.

Replacement parts shall be in accordance with the manufacturer's specifications.

(3) Repair to intrinsically Safe Components

Do not apply any permanent inductive or capacitance loads to the circuit without ensuring that this will not exceed the permissible voltage and current permitted for the equipment in use.

Intrinsically safe components are the only types that can be worked on while live in the presence of a flammable atmosphere. The test apparatus shall be at the correct rating.

Replace components only with parts specified by the manufacturer. Other parts may result in the ignition of refrigerant in the atmosphere from a leak.

(4) Cabling

Check that cabling will not be subject to wear, corrosion, excessive pressure, vibration, sharp edges or any other adverse environmental effects. The check shall also take into account the effects of aging or continual vibration from sources such as compressors or fans.

(5) Detection of Flammable Refrigerants

Under no circumstances shall potential sources of ignition be used in the searching for or detection of refrigerant leaks. A halide torch (or any other detector using a naked flame) shall not be used.

(6) Leak Detection Methods

Electronic leak detectors may be used to detect refrigerant leaks but, in the case of flammable refrigerants, the sensitivity may not be adequate, or may need re-calibration. (Detection equipment shall be calibrated in a refrigerant-free area.)

Ensure that the detector is not a potential source of ignition and is suitable for the refrigerant used. Leak detection equipment shall be set at a percentage of the LFL of the refrigerant and shall be calibrated to the refrigerant employed, and the appropriate percentage of gas (25% maximum) is confirmed.

Leak detection fluids are suitable for use with most refrigerants but the use of detergents containing chlorine shall be avoided as the chlorine may react with the refrigerant and corrode the copper pipe-work.

If a leak is suspected, all naked flames shall be removed/extinguished.

If a leakage of refrigerant is found which requires brazing, all of the refrigerant shall be recovered from the system, or isolated (by means of shut off valves) in a part of the system remote from the leak. For appliances containing flammable refrigerants, oxygen free nitrogen (OFN) shall then be purged through the system both before and during the brazing process.

(7) Removal and Evacuation

When breaking into the refrigerant circuit to make repairs – or for any other purpose conventional procedures shall be used. However, for flammable refrigerants it is important that best practice is followed since flammability is a consideration. The following procedure shall be adhered to:

- remove refrigerant
- purge the circuit with inert gas
- evacuate
- purge again with inert gas
- open the circuit by cutting or brazing.

The refrigerant charge shall be recovered into the correct recovery cylinders. For appliances containing flammable refrigerants, the system shall be “flushed” with OFN to render the unit safe. This process may need to be repeated several times.

Compressed air or oxygen shall not be used for purging refrigerant systems.

For appliances containing flammable refrigerants, flushing shall be achieved by breaking the vacuum in the system with OFN and continuing to fill until the working pressure is achieved, then venting to atmosphere, and finally pulling down to a vacuum. This process shall be repeated until no refrigerant is within the system. When the final OFN charge is used, the system shall be vented down to atmospheric pressure to enable work to take place. This operation is absolutely vital if brazing operations on the pipe-work are to take place.

Ensure that the outlet for the vacuum pump is not close to any ignition sources and that ventilation is available.

(8) Charging Procedures

In addition to conventional charging procedures, the following requirements shall be followed:

- Ensure that contamination of different refrigerants does not occur when using charging equipment. Hoses or lines shall be as short as possible to minimize the amount of refrigerant contained in them.
- Cylinders shall be kept upright.
- Ensure that the refrigeration system is earthed prior to charging the system with refrigerant.
- Label the system when charging is complete (if not already).
- Extreme care shall be taken not to overfill the refrigeration system.

Prior to recharging the system, it shall be pressure-tested with the appropriate purging gas. The system shall be leak-tested on completion of charging but prior to commissioning. A follow up leak test shall be carried out prior to leaving the site.

(9) Decommissioning

Before carrying out this procedure, it is essential that the technician is completely familiar with the equipment and all its detail. It is recommended good practice that all refrigerants are recovered safely. Prior to the task being carried out, an oil and refrigerant sample shall be taken in case analysis is required prior to re-use of reclaimed refrigerant. It is essential that electrical power is available before the task is commenced.

- a) Become familiar with the equipment and its operation.

- b) Isolate system electrically.
- c) Before attempting the procedure, ensure that:
 - mechanical handling equipment is available, if required, for handling refrigerant cylinders;
 - all personal protective equipment is available and being used correctly;
 - the recovery process is supervised at all times by a competent person;
 - recovery equipment and cylinders conform to the appropriate standards.
- d) Pump down refrigerant system, if possible.
- e) If a vacuum is not possible, make a manifold so that refrigerant can be removed from various parts of the system.
- f) Make sure that cylinder is situated on the scales before recovery takes place.
- g) Start the recovery machine and operate in accordance with manufacturer's instructions.
- h) Do not overfill cylinders. (No more than 80 % volume liquid charge).
- i) Do not exceed the maximum working pressure of the cylinder, even temporarily.
- j) When the cylinders have been filled correctly and the process completed, make sure that the cylinders and the equipment are removed from site promptly and all isolation valves on the equipment are closed off.
- k) Recovered refrigerant shall not be charged into another refrigeration system unless it has been cleaned and checked.

(10) Labelling

Equipment shall be labelled stating that it has been de-commissioned and emptied of refrigerant. The label shall be dated and signed. For appliances containing flammable refrigerants, ensure that there are labels on the equipment stating the equipment contains flammable refrigerant.

(11) Recovery

When removing refrigerant from a system, either for servicing or decommissioning, it is recommended good practice that all refrigerants are removed safely. When transferring refrigerant into cylinders, ensure that only appropriate refrigerant recovery cylinders are employed. Ensure that the correct number of cylinders for holding the total system charge are available. All cylinders to be used are designated for the recovered refrigerant and labelled for that refrigerant (i.e. special cylinders for the recovery of refrigerant). Cylinders shall be complete with pressure-relief valve and associated shut-off valves in good working order. Empty recovery cylinders are evacuated and, if possible, cooled before recovery occurs.

The recovery equipment shall be in good working order with a set of instructions concerning the equipment that is at hand and shall be suitable for the recovery of all appropriate refrigerants including, when applicable, flammable refrigerants. In addition, a set of calibrated weighing scales shall be available and in good working order. Hoses shall be complete with leak-free disconnect couplings and in good condition. Before using the recovery machine, check that it is in satisfactory working order, has been properly maintained and that any associated electrical components are sealed to prevent ignition in the event of a refrigerant release. Consult manufacturer if in doubt.

The recovered refrigerant shall be returned to the refrigerant supplier in the correct recovery cylinder, and the relevant waste transfer note arranged. Do not mix refrigerants in recovery units and especially not in cylinders. If compressors or compressor oils are to be removed, ensure that they have been evacuated to an acceptable level to make certain that flammable refrigerant does not remain within the lubricant. The evacuation process shall be carried out prior to returning the compressor to the suppliers. Only electric heating to the compressor body shall be employed to accelerate this process. When oil is drained from a system, it shall be carried out safely.

2-3. Choosing the outdoor unit installation location

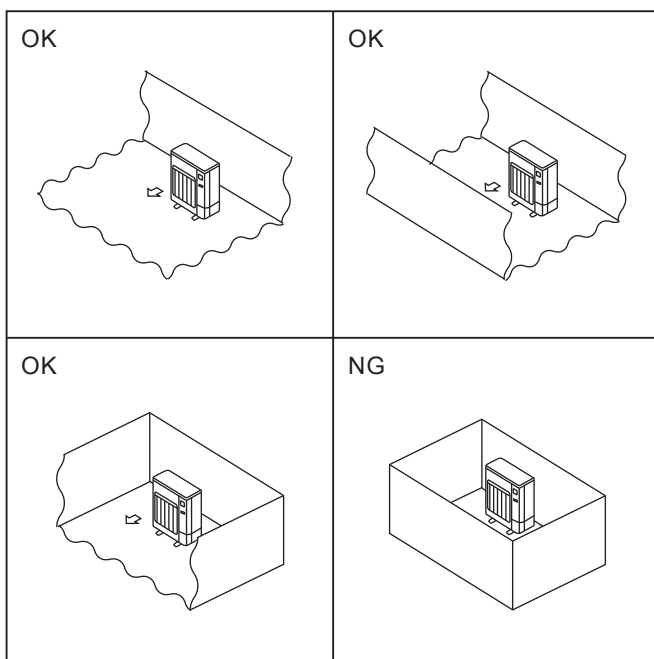

R32 is heavier than air—as well as other refrigerants—so tends to accumulate at the base (in the vicinity of the floor). If R32 accumulates around base, it may reach a flammable concentration in case room is small. To avoid ignition, maintaining a safe work environment is required by ensuring appropriate ventilation. If a refrigerant leak is confirmed in a room or an area where there is insufficient ventilation, refrain from using of flames until the work environment can be improved by ensuring appropriate ventilation.

Install outdoor units in a place where at least one of the four sides is open, and in a sufficiently large space without depressions.

2-4. Minimum installation area

If you unavoidably install a unit in a space where all four sides are blocked or there are depressions, confirm that one of these situations (A, B or C) is satisfied.

Note: These countermeasures are for keeping safety not for specification guarantee.

A) Secure sufficient installation space (minimum installation area A_{min}).

Install in a space with an installation area of A_{min} or more, corresponding to refrigerant amount M (factory-charged refrigerant + locally added refrigerant).

M [kg]	A_{min} [m ²]
1.0	12
1.5	17
2.0	23
2.5	28
3.0	34
3.5	39
4.0	45
4.5	50
5.0	56
5.5	62
6.0	67
6.5	73
7.0	78
7.5	84

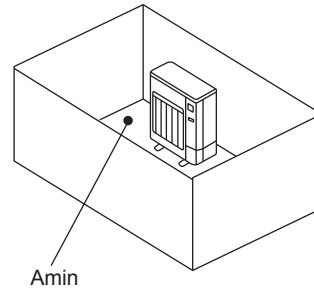

B) Install in a space with a depression height of ≤ 0.125 [m]

Height from the bottom of
0.125 [m] or less

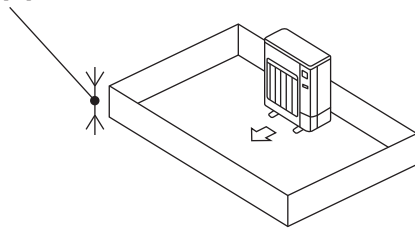

Height from the bottom of
0.125 [m] or less

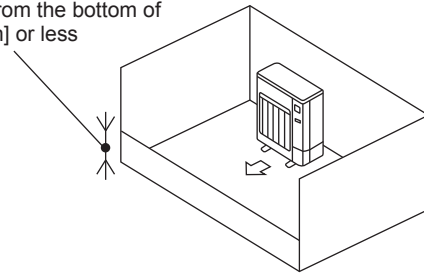

C) Create an appropriate ventilation open area.

Make sure that the width of the open area is 0.9 [m] or more and the height of the open area is 0.15 [m] or more.

However, the height from the bottom of the installation space to the bottom edge of the open area should be 0.125 [m] or less.

Open area should be 75% or more opening.

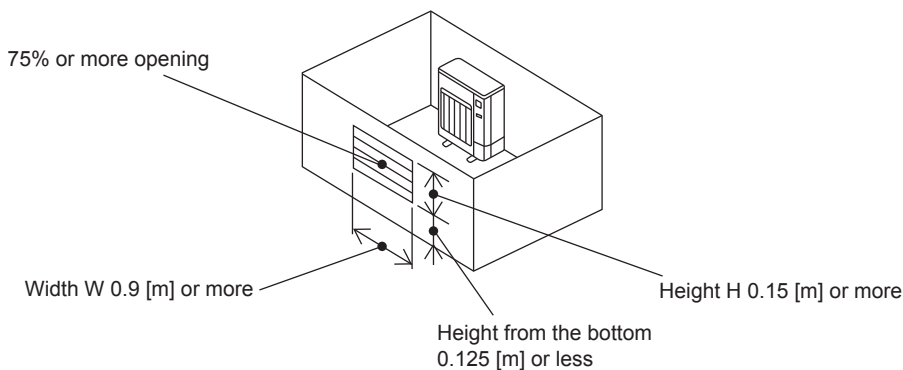

■ Indoor units

Install in a room with a floor area of A_{min} or more, corresponding to refrigerant amount M (factory-charged refrigerant + locally added refrigerant).

* For the factory-charged refrigerant amount, refer to the spec nameplate or installation manual.

For the amount to be added locally, refer to the installation manual.

Install the indoor unit so that the height from the floor to the bottom of the indoor unit is h_0 ;

for wall mounted: 1.8 m or more

for ceiling suspended, cassette and ceiling concealed: 2.2 m or more

for floor standing (PSA-M): 0 m

for floor standing (MFZ-KT): Refer to indoor unit installation manual.

for floor standing concealed: Refer to indoor unit installation manual.

* There are restrictions in installation height for each model, so read the installation manual for the particular unit.

Case 1: for wall mounted, ceiling suspended, cassette and concealed

M [kg]	A_{min} [m ²]
1.0	4
1.5	6
2.0	8
2.5	10
3.0	12
3.5	14
4.0	16
4.5	20
5.0	24
5.5	29
6.0	35
6.5	41
7.0	47
7.5	54

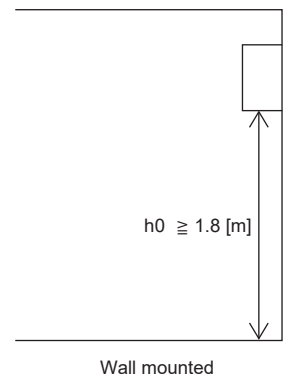

Wall mounted

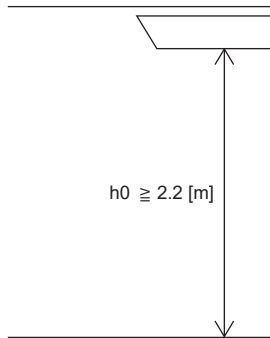

Ceiling suspended

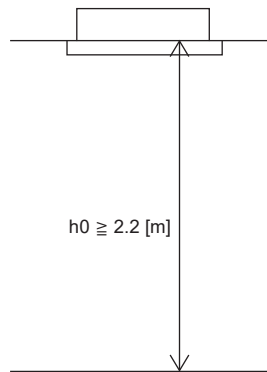

Cassette

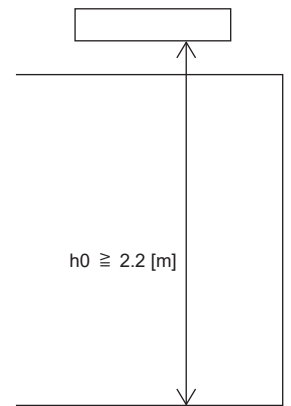

Ceiling concealed

Case 2: for floor standing (PSA-M)

M [kg]	A_{min} [m ²]
< 1.84	No requirements
1.84	6
2.0	6
2.5	7
3.0	9
3.5	10
4.0	11
4.5	13
5.0	14
5.5	15
6.0	17
6.5	18
7.0	20
7.5	21

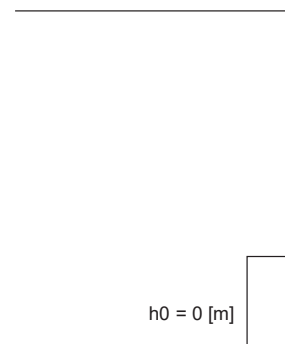

Floor standing (PSA-M)

Case 3: for floor standing (MFZ-KT)

M [kg]	Amin [m ²]
1.00	No requirements
1.10	
1.20	
1.30	
1.40	
1.50	
1.60	
1.70	
1.80	
1.84	
1.90	3.75
2.00	3.95
2.10	4.15
2.20	4.34
2.30	4.54
2.40	4.74

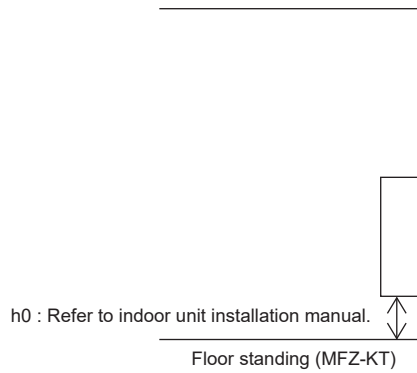

Case 4: for floor standing concealed

Case 4-1: When duct is installed

M [kg]	Amin [m ²]		
	$h \geq 1.8$	$1.4 \leq h < 1.8$	$1.0 \leq h < 1.4$
1.00	No requirements		
1.10			
1.20			
1.30			
1.40			
1.50			
1.60			
1.70			
1.80			
1.84			
1.90	4.6	5.9	8.3
2.00	4.9	6.3	8.7
2.10	5.1	6.6	9.2
2.20	5.4	6.9	9.6
2.30	5.6	7.2	10.0
2.40	5.8	7.5	10.5

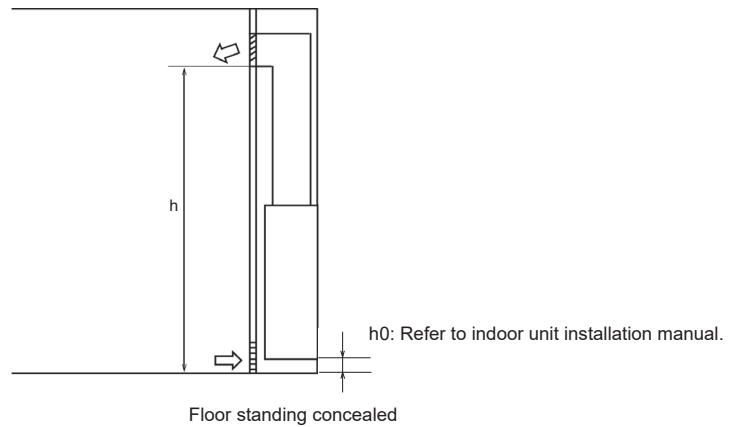

* The height h of the air outlet port shall not be less than 1.0 m

Case 4-2: When air outlet grille is installed

M [kg]	Amin [m ²]		
	$\varphi = 90^\circ$	$60^\circ \leq \varphi < 90^\circ$	$30^\circ \leq \varphi < 60^\circ$
1.00	No requirements		
1.10			
1.20			
1.30			
1.40			
1.50			
1.60			
1.70			
1.80			
1.84			
1.90	4.3	5.1	8.6
2.00	4.5	5.4	9.0
2.10	4.7	5.7	9.5
2.20	4.9	5.9	9.9
2.30	5.2	6.2	10.4
2.40	5.4	6.5	10.8

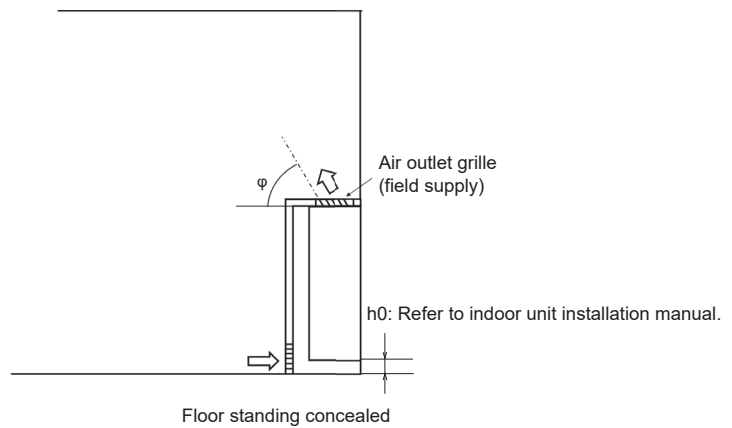

* The grille angle shall not be less than 30°

3

PARTS NAMES AND FUNCTIONS

SUZ-M25VA.TH
 SUZ-M25VAR1.TH
 SUZ-M25VAR2.TH
 SUZ-M25VA-ET.TH
 SUZ-M25VA-ETR2.TH
 SUZ-M35VA.TH
 SUZ-M35VAR1.TH
 SUZ-M35VAR2.TH
 SUZ-M35VA-ET.TH
 SUZ-M35VA-ETR2.TH

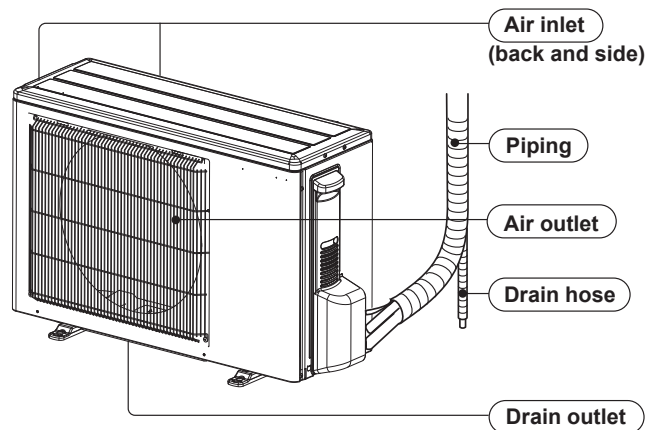

SUZ-M50VA.TH
 SUZ-M50VAR1.TH
 SUZ-M50VAR2.TH
 SUZ-M50VA-ET.TH
 SUZ-M50VA-ETR2.TH

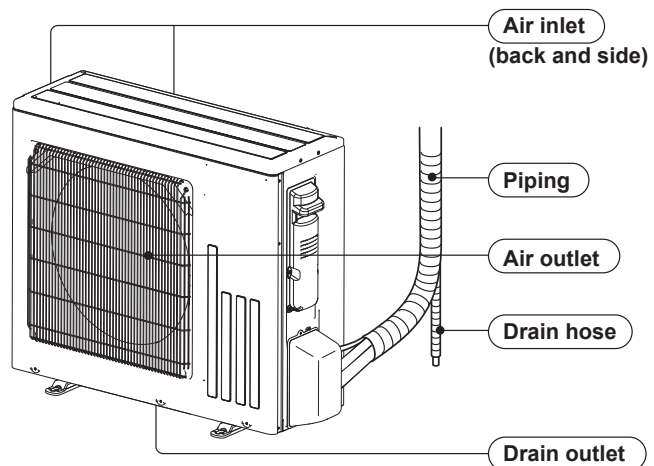

SUZ-M60VA.TH
 SUZ-M60VAR1.TH
 SUZ-M60VAR2.TH
 SUZ-M60VA-ET.TH
 SUZ-M60VA-ETR2.TH
 SUZ-M71VA.TH
 SUZ-M71VAR1.TH
 SUZ-M71VA-ET.TH
 SUZ-M71VA-ETR1.TH

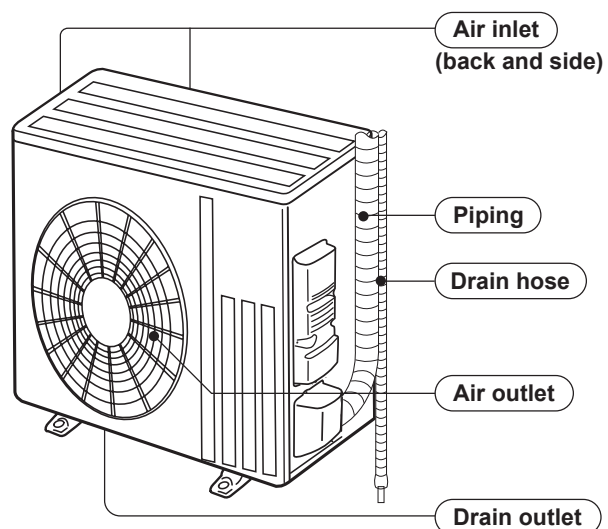

Model	SUZ-M·VA
Drain socket	1

4

SPECIFICATION

Service ref.				SUZ-M25VA.TH SUZ-M25VAR1.TH SUZ-M25VAR2.TH SUZ-M25VA-ET.TH SUZ-M25VA-ETR2.TH	SUZ-M35VA.TH SUZ-M35VAR1.TH SUZ-M35VAR2.TH SUZ-M35VA-ET.TH SUZ-M35VA-ETR2.TH	SUZ-M50VA.TH SUZ-M50VAR1.TH SUZ-M50VAR2.TH SUZ-M50VA-ET.TH SUZ-M50VA-ETR2.TH	SUZ-M60VA.TH SUZ-M60VAR1.TH SUZ-M60VAR2.TH SUZ-M60VA-ET.TH SUZ-M60VA-ETR2.TH	SUZ-M71VA.TH SUZ-M71VAR1.TH SUZ-M71VA-ET.TH SUZ-M71VA-ETR1.TH		
Power supply				Single phase 230 V, 50 Hz						
Compressor	Model			KVB073FYXMC	SVB092FBAMT	SVB130FBBMT		SVB172FCKMT		
	Output		W	470	660	900		1,200		
	Current*	Cooling	A	3.0	4.1	7.1	8.4	9.1		
		Heating		3.7	5.0	8.0	9.3	9.5		
Refrigeration oil (Model)			L	0.27 (FW68S)	0.35 (FW68S)		0.40 (FW68S)			
Fan motor	Model			RC0J50-NC		RC0J50-RA	RC0J60-BC			
	Current*	Cooling	A	0.22	0.20	0.29	0.84			
		Heating		0.20	0.23	0.29	0.84			
Dimensions W × H × D			mm	800 × 550 × 285		800 × 714 × 285	840 × 880 × 330			
Weight			kg	30	35	41	54	55		
Special remarks	Air flow*	Cooling	High	m ³ /h	2,178	2,058	2,748	3,006		
			Low		1,038	906	1,320	1,716		
		Heating	High		2,076	1,962	2,622	3,006		
			Med.		1,788	1,686	2,238	2,892		
			Low		1,452	1,260	1,704	2,280		
	Sound pressure level*		Cooling	dB(A)	45	48		49		
			Heating		46	48	49	51		
	Sound power level				59	64	65	66		
	Fan speed	Cooling	High	rpm	940		840			
			Low		470	460	490	450		
		Heating	High		900		840		860	
			Med.		780		810			
			Low		640	600	610	650		
Fan speed regulator				3						
Refrigerant filling capacity (R32)			kg	0.65	0.90	1.20	1.25	1.45		

Note: Test conditions are based on ISO 5151

Cooling: Indoor D.B. 27°C W.B. 19°C

Outdoor D.B. 35°C

Heating: Indoor D.B. 20°C

Outdoor D.B. 7°C W.B. 6°C

Refrigerant piping length (one way): 5 m

*Measured under rated operating frequency.

Specifications and rating conditions of main electric parts

Item	Service ref.	SUZ-M25VA.TH	SUZ-M35VA.TH	SUZ-M50VA.TH	SUZ-M60VA.TH	SUZ-M71VA.TH
		SUZ-M25VAR1.TH SUZ-M25VAR2.TH SUZ-M25VA-ET.TH SUZ-M25VA-ETR2.TH	SUZ-M35VAR1.TH SUZ-M35VAR2.TH SUZ-M35VA-ET.TH SUZ-M35VA-ETR2.TH	SUZ-M50VAR1.TH SUZ-M50VAR2.TH SUZ-M50VA-ET.TH SUZ-M50VA-ETR2.TH	SUZ-M60VAR1.TH SUZ-M60VAR2.TH SUZ-M60VA-ET.TH SUZ-M60VA-ETR2.TH	SUZ-M71VAR1.TH SUZ-M71VA-ET.TH SUZ-M71VA-ETR1.TH
Smoothing capacitor	(C61)	—	620 μF 420 V	620 μF 420 V	—	—
	(C62, C63)	620 μF 420 V	620 μF 420 V	620 μF 420 V	—	—
	(CB1, 2, 3)	—	—	—	560 μF 450 V	
Diode module	(DB61)	15 A 600 V	15 A 600 V	25 A 600 V	—	—
	(DB65)	25 A 600 V			—	—
Fuse	(F61)	25 A 250 V			—	—
	(F62)	15 A 250 V			—	—
	(F701, F801, F901)	T3.15 A L250 V			—	—
	(F601, F880, F901)	—	—	—	T3.15 A L250 V	
Power module	(IC700)	15 A 600 V		20 A 600 V		
	(IC932)	5 A 600 V				
Switch power transistor	(Q821)	30 A 600 V			—	—
Expansion valve coil	(LEV)	12 V DC				
Reactor	(L61)	18 mH	23 mH		—	—
	(L)	—	—	—	282 μH	
Diode	(D3A, D3B)	—	—	—	20 A 600 V	
Diode module	(DB41A, DB41B)	—	—	—	20 A 600 V	
Current-Limiting PTC thermistor	(PTC64, PTC65)	33Ω				
Terminal block	(TB1)	5P			3P	
Relay	(X63)	3 A 250 V			—	—
	(X64)	20 A 250 V				
	(X601)	—	—	—	3 A 250 V	
	(X602)	—	—	—	3 A 250 V	
R.V. coil	(21S4)	220–240 V AC				

5

NOISE CRITERIA CURVES

SUZ-M25VA.TH
 SUZ-M25VAR1.TH
 SUZ-M25VAR2.TH
 SUZ-M25VA-ET.TH
 SUZ-M25VA-ETR2.TH

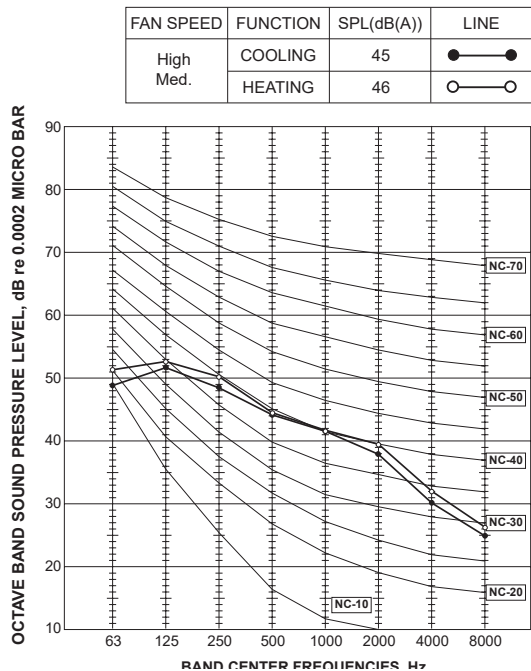

SUZ-M35VA.TH
 SUZ-M35VAR1.TH
 SUZ-M35VAR2.TH
 SUZ-M35VA-ET.TH
 SUZ-M35VA-ETR2.TH

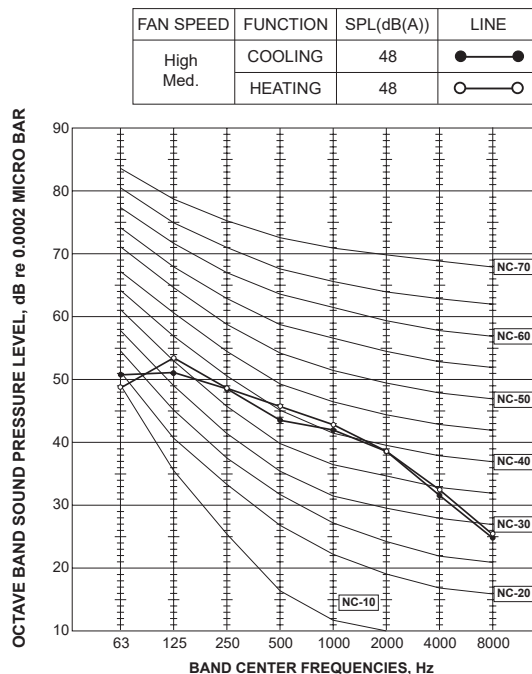

SUZ-M50VA.TH
 SUZ-M50VAR1.TH
 SUZ-M50VAR2.TH
 SUZ-M50VA-ET.TH
 SUZ-M50VA-ETR2.TH

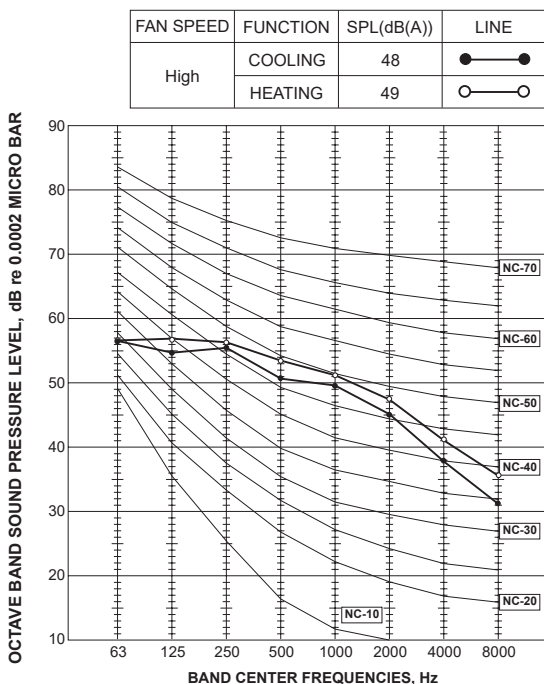

SUZ-M60VA.TH
 SUZ-M60VAR1.TH
 SUZ-M60VAR2.TH
 SUZ-M60VA-ET.TH
 SUZ-M60VA-ETR2.TH

SUZ-M71VA.TH
 SUZ-M71VAR1.TH
 SUZ-M71VA-ET.TH
 SUZ-M71VA-ETR1.TH

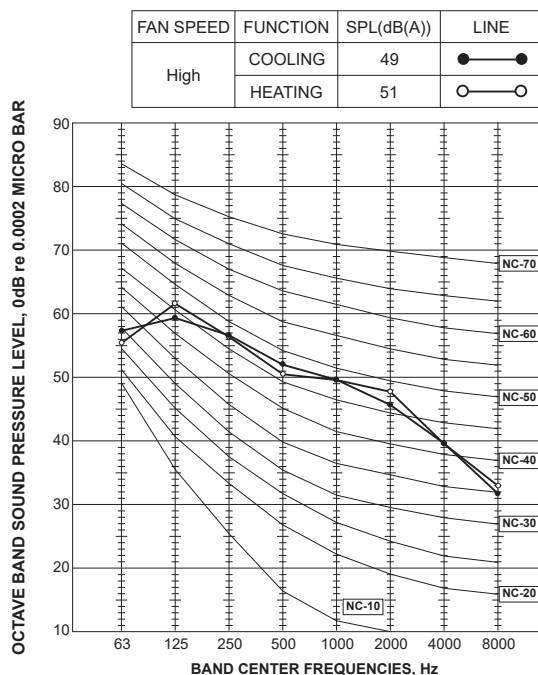

Test conditions

Cooling: Dry-bulb temperature 35°C
 Heating: Dry-bulb temperature 7°C
 Wet-bulb temperature 6°C

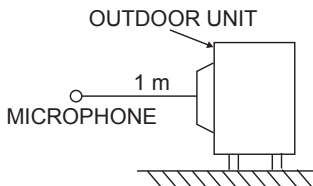

Unit: mm

SUZ-M25VA.TH
 SUZ-M25VAR1.TH
 SUZ-M25VAR2.TH
 SUZ-M25VA-ET.TH
 SUZ-M25VA-ETR2.TH

SUZ-M35VA.TH
 SUZ-M35VAR1.TH
 SUZ-M35VAR2.TH
 SUZ-M35VA-ET.TH
 SUZ-M35VA-ETR2.TH

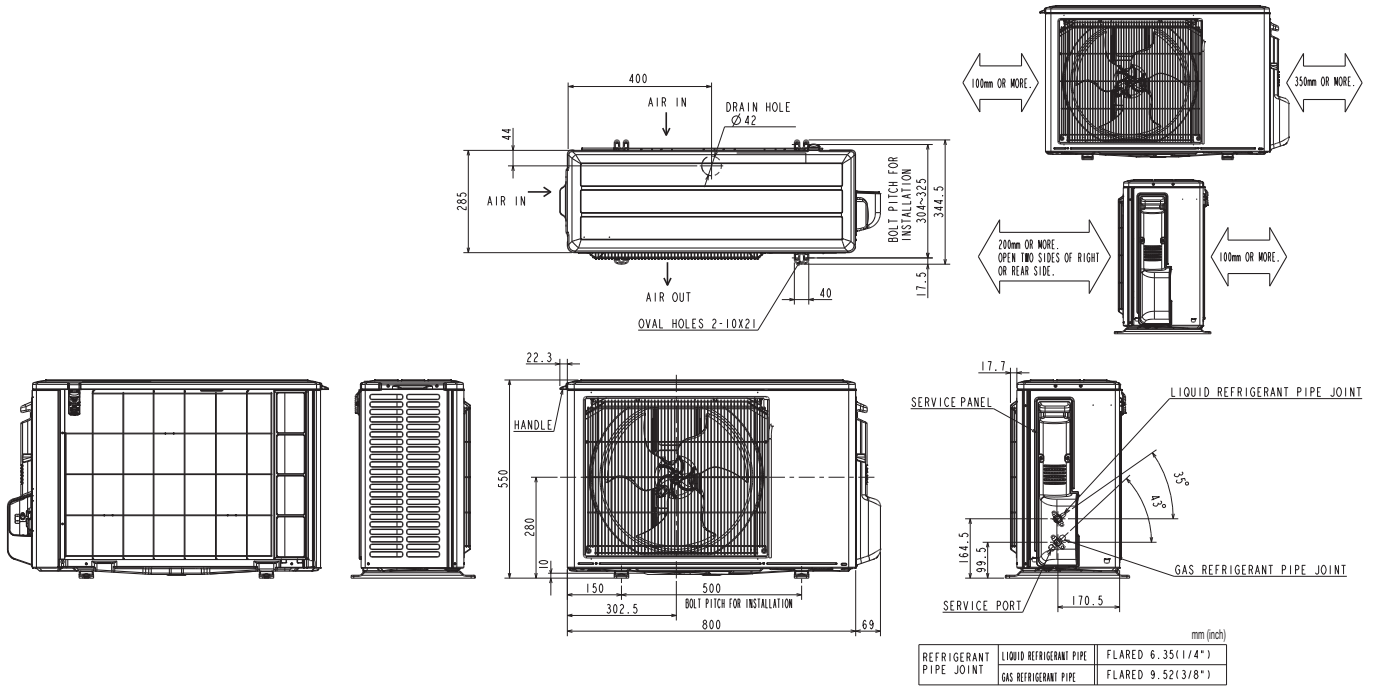

SUZ-M50VA.TH
 SUZ-M50VAR1.TH
 SUZ-M50VAR2.TH
 SUZ-M50VA-ET.TH
 SUZ-M50VA-ETR2.TH

Unit: mm

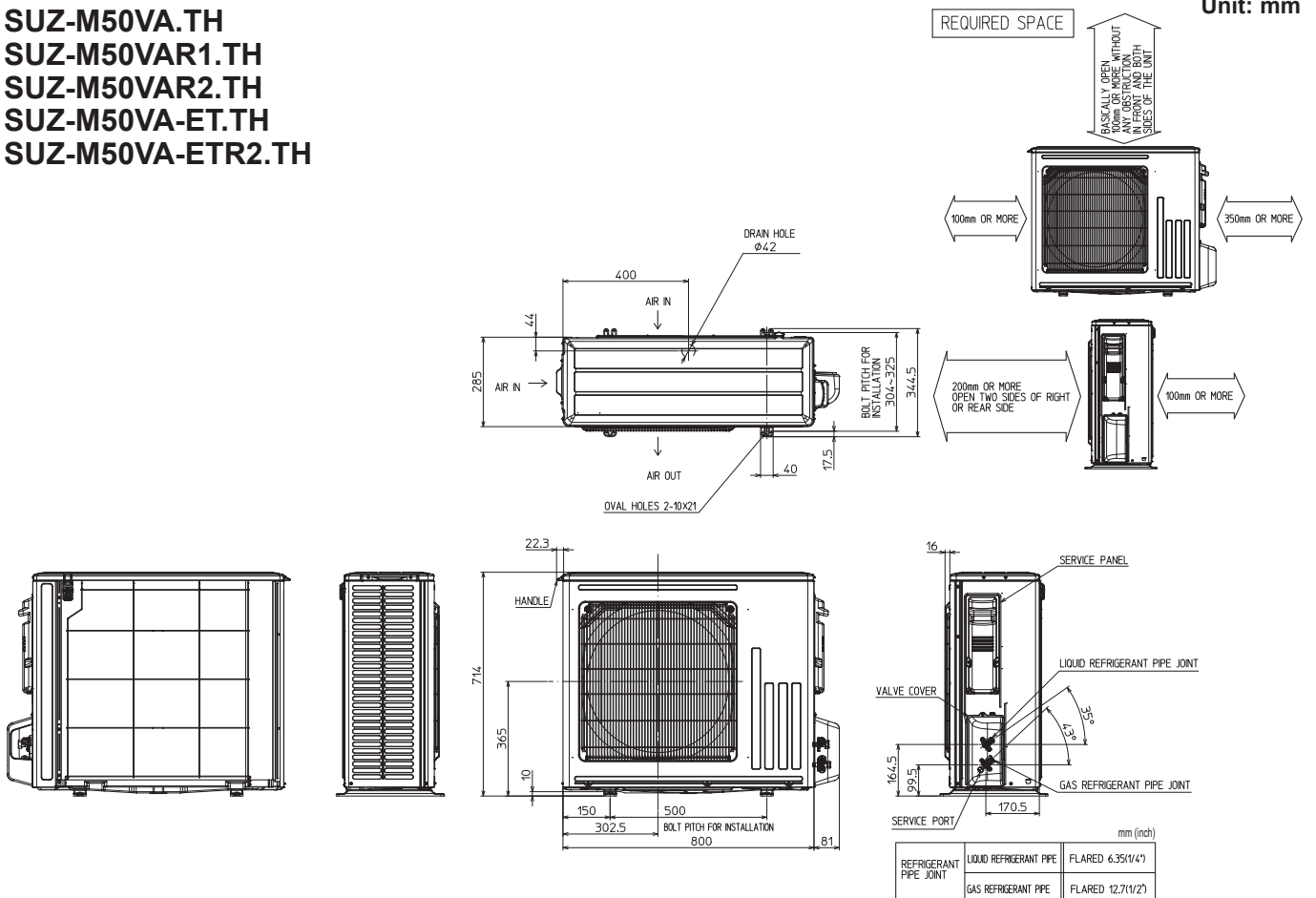

SUZ-M60VA.TH
 SUZ-M60VAR1.TH
 SUZ-M60VAR2.TH
 SUZ-M60VA-ET.TH
 SUZ-M60VA-ETR2.TH

SUZ-M71VA.TH
 SUZ-M71VAR1.TH
 SUZ-M71VA-ET.TH
 SUZ-M71VA-ETR1.TH

Unit: mm

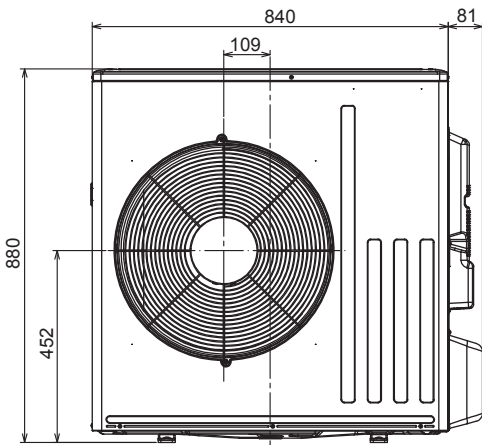
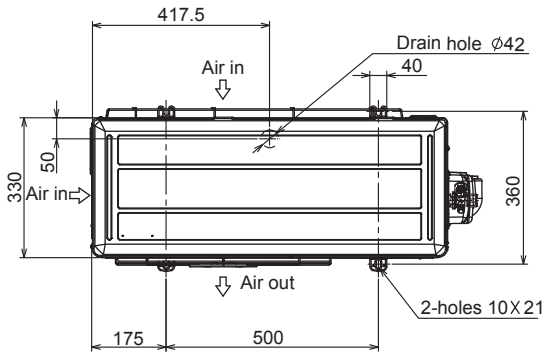

REQUIRED SPACE

*1 500 mm or more when front and sides of the unit are clear

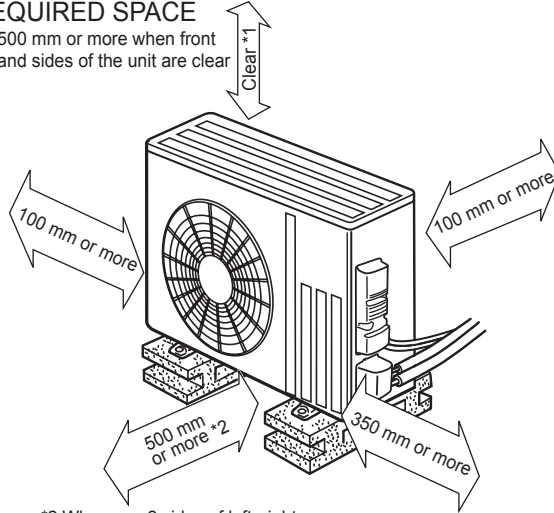

*2 When any 2 sides of left, right and rear of the unit are clear

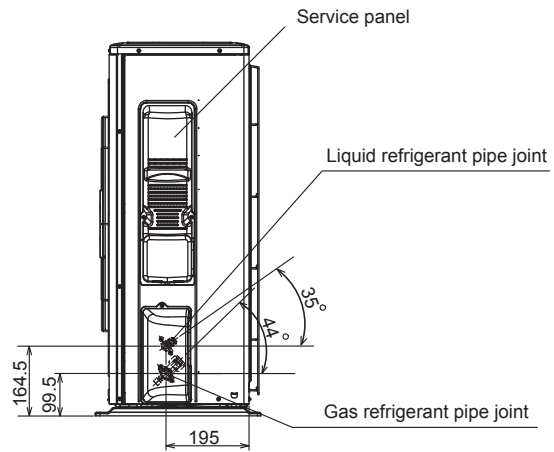



mm (inch)

MODEL NAME		SUZ-M60VA	SUZ-M71VA
REFRIGERANT PIPE JOINT	LIQUID REFRIGERANT PIPE	FLARED 6.35(1/4")	FLARED 9.52(3/8")
	GAS REFRIGERANT PIPE	FLARED 15.88(5/8")	

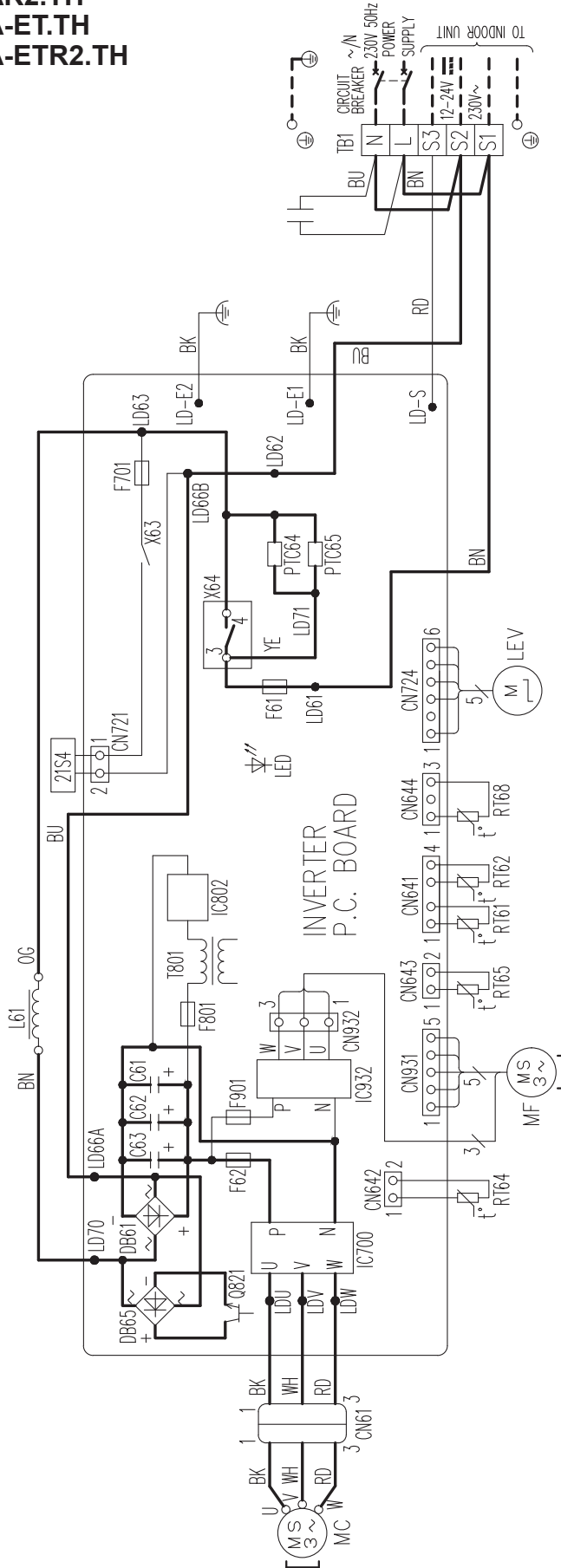
SUZ-M35VA.TH
 SUZ-M35VAR1.TH
 SUZ-M35VAR2.TH
 SUZ-M35VA-ET.TH
 SUZ-M35VA-ETR2.TH



NOTES:

1. About the indoor side electric wiring, refer to the indoor unit electric wiring diagram for servicing.
2. Use copper supply wires.
3. Symbols indicate,  : Terminal block,  : Connector

SYMBOL	NAME	SYMBOL	NAME	SYMBOL	NAME
CN61	CONNECTOR	LEV	EXPANSION VALVE COIL	RT65	AMBIENT TEMP. THERMISTOR
C61, C62, C63	SMOOTHING CAPACITOR	L61	REACTOR	RT68	OUTDOOR HEAT EXCHANGER TEMP. THERMISTOR
DB61, DB65	DIODE MODULE	MC	COMPRESSOR	TB1	TERMINAL BLOCK
F61	FUSE (25A, 250V)	MF	FAN MOTOR	T801	TRANSFORMER
F701, F801, F901	FUSE (13.15A/1250V)	O821	CIRCUIT PROTECTION	X63, X64	SWITCHING POWER TRANSISTOR
IC700, IC932	POWER MODULE	RT61	DEFROST THERMISTOR	Z1S4	RELAY
IC802	POWER DEVICE	RT62	DISCHARGE TEMP. THERMISTOR		REVERSING VALVE COIL
LED	LED	RT64	FIN TEMP. THERMISTOR		

SUZ-M50VA.TH
SUZ-M50VAR1.TH
SUZ-M50VAR2.TH
SUZ-M50VA-ET.TH
SUZ-M50VA-ETR2.TH

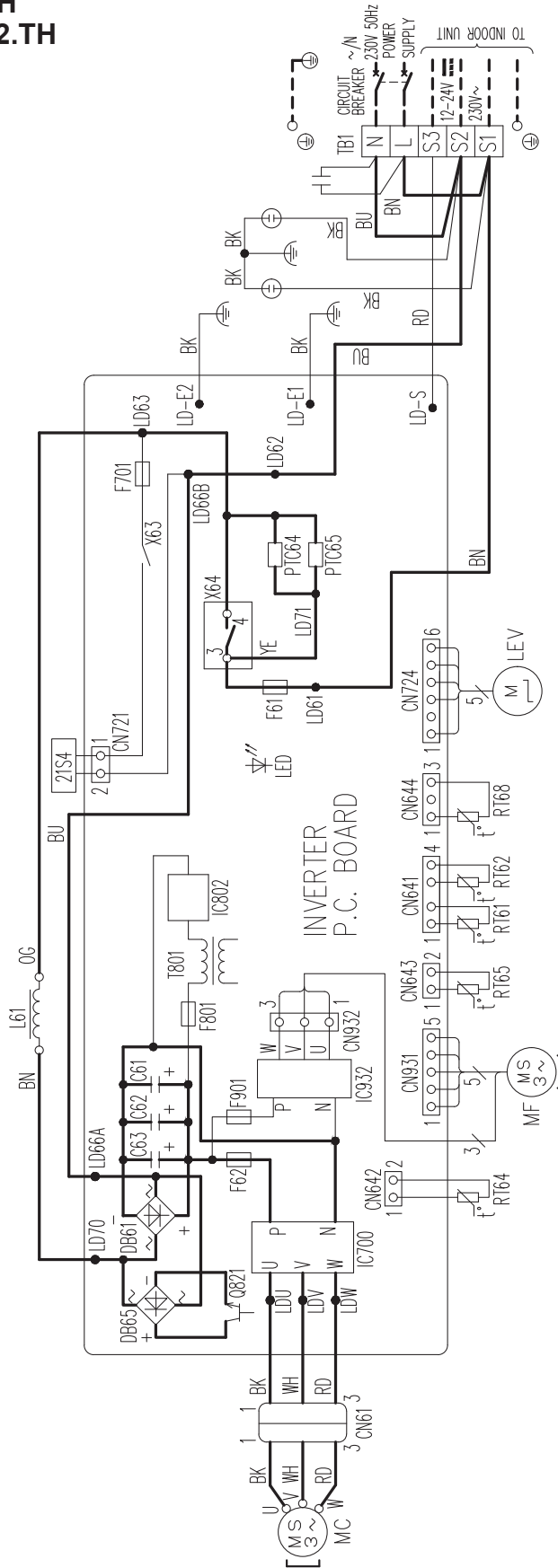

NOTES:

- 1.About the indoor side electric wiring, refer to the indoor unit electric wiring diagram for servicing.
- 2.Use copper supply wires.
- 3.Symbols indicate, : Terminal block : Connector

SYMBOL	NAME	SYMBOL	NAME	SYMBOL	NAME
CN61	CONNECTOR	LEV	EXPANSION VALVE COIL	RT65	AMBIENT TEMP. THERMISTOR
C61,C62,C63	SMOOTHING CAPACITOR	L61	REACTOR	RT68	OUTDOOR HEAT EXCHANGER TEMP. THERMISTOR
DB61,DB65	DIODE MODULE	MC	COMPRESSOR	TB1	TERMINAL BLOCK
F61	FUSE (15A, 250V)	MF	FAN MOTOR	PTC64, PTC65	CIRCUIT PROTECTION TRANSFORMER
F701,F801,F901	FUSE (13.5A/250V)	O821	SWITCHING POWER TRANSISTOR	X63,X64	RELAY
IC700,IC932	POWER MODULE	RT65	DEFROST THERMISTOR	Z1S4	REVERSING VALVE COIL
IC802	POWER DEVICE	RT66	DISCHARGE TEMP. THERMISTOR		
LED	LED	RT64	FIN TEMP. THERMISTOR		

SUZ-M60VA.TH
 SUZ-M60VAR1.TH
 SUZ-M60VAR2.TH
 SUZ-M60VA-ET.TH
 SUZ-M60VA-ETR2.TH

SUZ-M71VA.TH
 SUZ-M71VAR1.TH
 SUZ-M71VA-ET.TH
 SUZ-M71VA-ETR1.TH

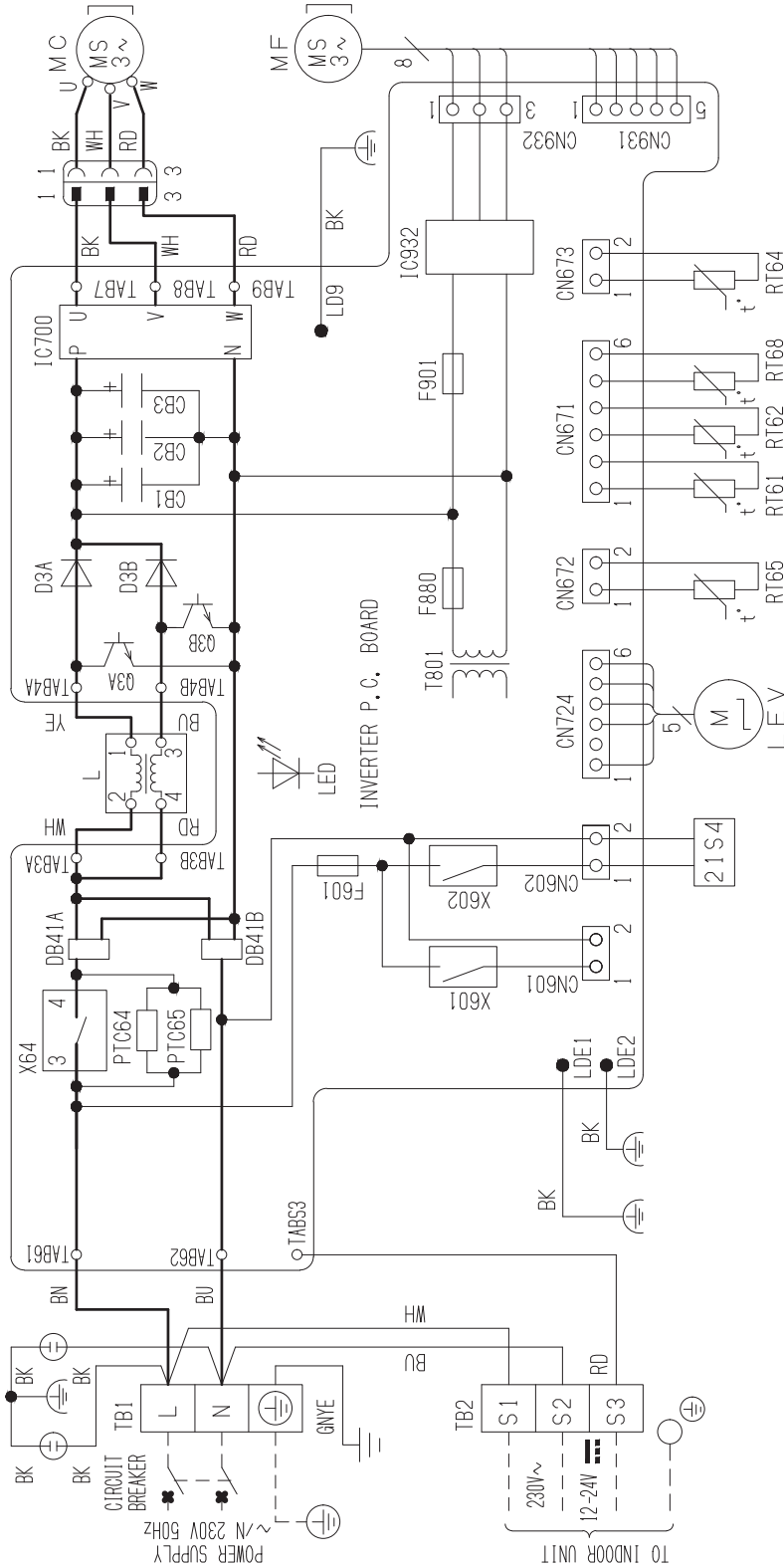

SYMBOL	NAME	SYMBOL	NAME	SYMBOL	NAME	SYMBOL	NAME
CB1, CB2, CB3	SMOOTHING CAPACITOR	L	REACTOR	RT61	DEFROST THERMISTOR	T801	TRANSFORMER
DB41A, DB41B	DIODE MODULE	LED	LED	RT62	DISCHARGE TEMP. THERMISTOR	X64	RELAY
D3A, D3B	DIODE	LEV	EXPANSION VALVE COIL	RT64	FIN TEMP. THERMISTOR	X601, X602	RELAY
F601	FUSE (T3, 15AL250V)	MC	COMPRESSOR	RT65	AMBIENT TEMP. THERMISTOR	21S4	REVERSING VALVE COIL
F880	FUSE (T3, 15AL250V)	MF	FAN MOTOR	RT68	OUTDOOR HEAT EXCHANGER TEMP. THERMISTOR		
F901	FUSE (T3, 15AL250V)	PT064, PT065	CIRCUIT PROTECTION	TB1, TB2	TERMINAL BLOCK		
IC700, IC932	POWER MODULE	Q3A, Q3B	SWITCHING POWER TRANSISTOR				

NOTES
 1. About the indoor side electric wiring, refer to the indoor unit electric wiring diagram for servicing.
 2. Use copper supply wires.
 3. Symbols indicate, □□□□: terminal block □□□□□□: Connector

SUZ-M25VA.TH
 SUZ-M25VAR1.TH
 SUZ-M25VAR2.TH
 SUZ-M25VA-ET.TH
 SUZ-M25VA-ETR2.TH

SUZ-M35VA.TH
 SUZ-M35VAR1.TH
 SUZ-M35VAR2.TH
 SUZ-M35VA-ET.TH
 SUZ-M35VA-ETR2.TH

Unit: mm

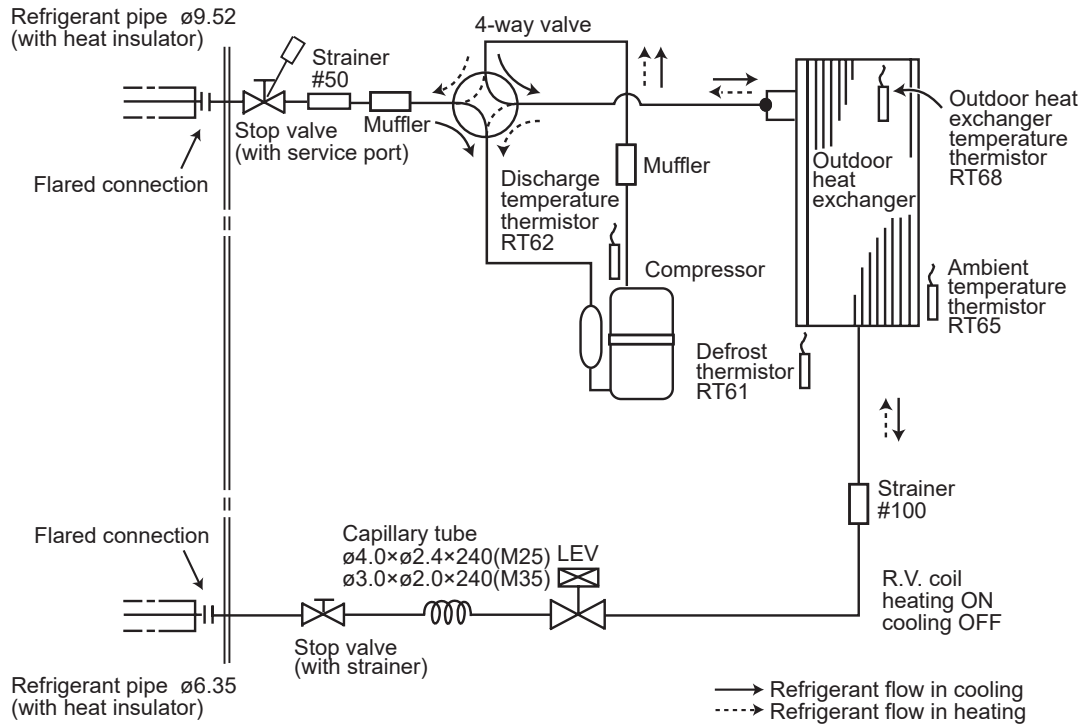

SUZ-M50VA.TH
 SUZ-M50VAR1.TH
 SUZ-M50VAR2.TH
 SUZ-M50VA-ET.TH
 SUZ-M50VA-ETR2.TH

Unit: mm

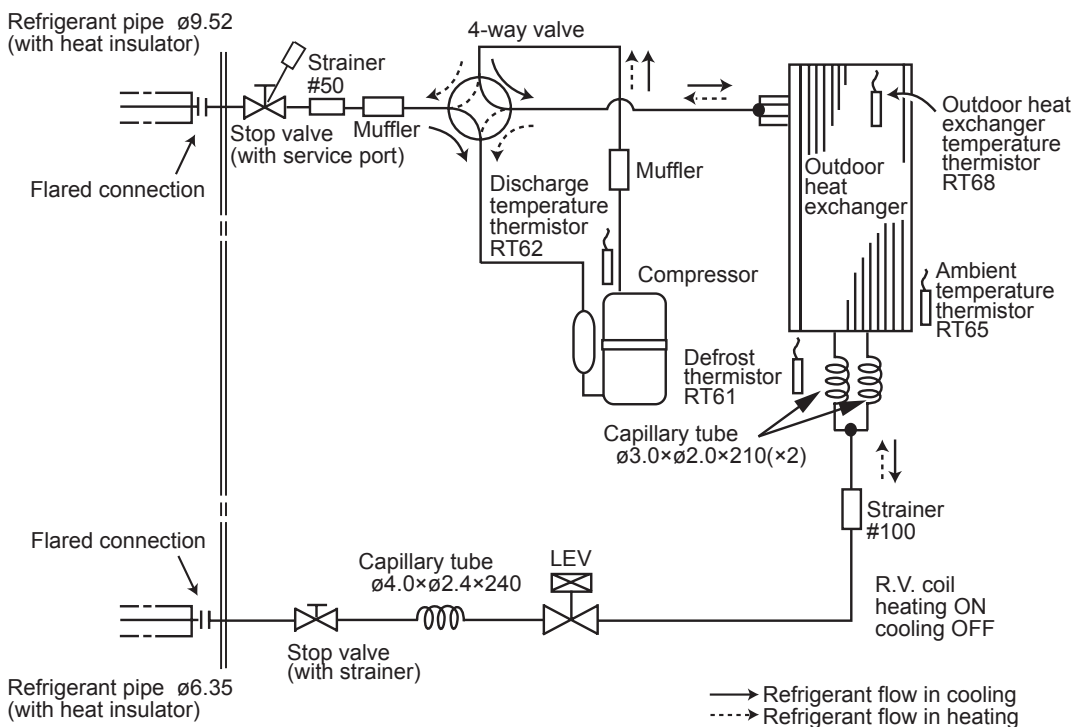

SUZ-M60VA.TH **SUZ-M71VA.TH**
SUZ-M60VAR1.TH **SUZ-M71VAR1.TH**
SUZ-M60VAR2.TH **SUZ-M71VA-ET.TH**
SUZ-M60VA-ET.TH **SUZ-M71VA-ETR1.TH**
SUZ-M60VA-ETR2.TH

Unit: mm

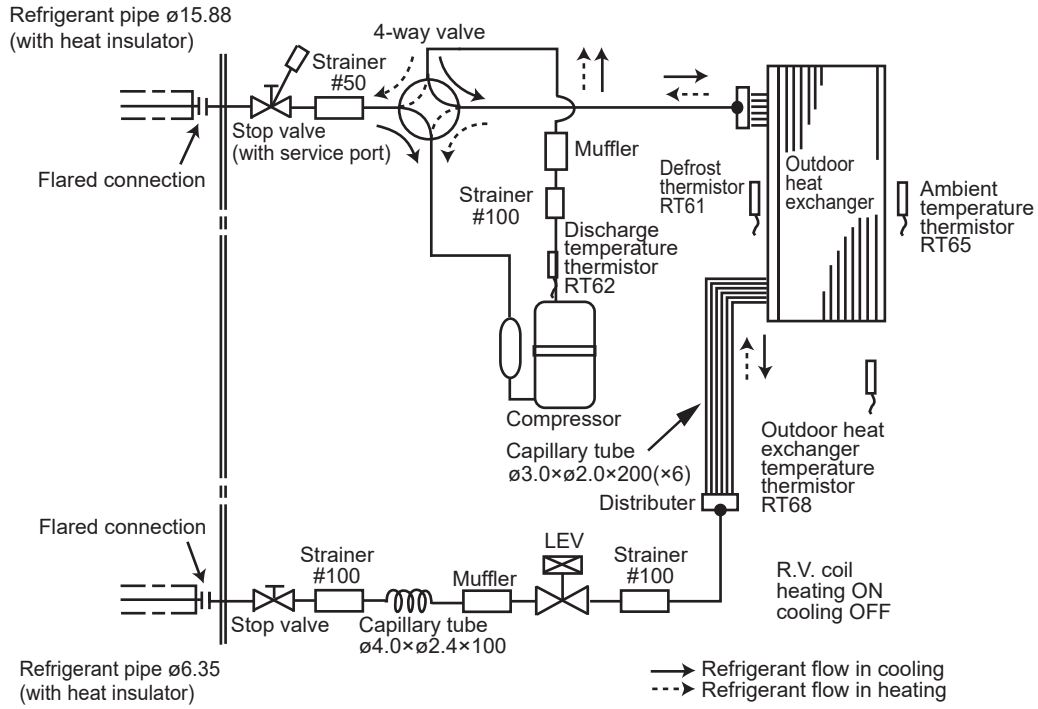

MAX. REFRIGERANT PIPING LENGTH

Service ref.	Refrigerant piping: m		Piping size O.D: mm	
	Max. Length A	Max. Height difference B	Gas	Liquid
SUZ-M25VA(R1/R2).TH SUZ-M25VA-ET(R2).TH	20	12	9.52	6.35
SUZ-M35VA(R1/R2).TH SUZ-M35VA-ET(R2).TH				
SUZ-M50VA(R1/R2).TH SUZ-M50VA-ET(R2).TH	30	30	12.7	
SUZ-M60VA(R1/R2).TH SUZ-M60VA-ET(R2).TH			15.88	
SUZ-M71VA(R1).TH SUZ-M71VA-ET(R1).TH				9.52

MAX. HEIGHT DIFFERENCE

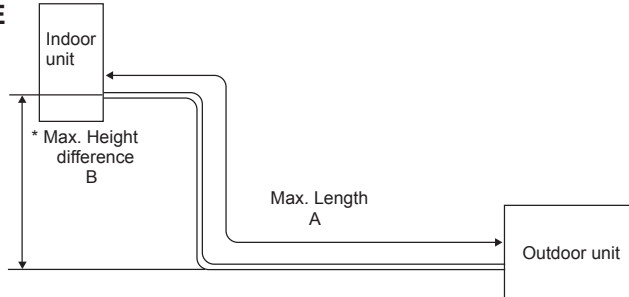

* Height difference limitations are binding regardless of the height position at which either indoor or outdoor is placed higher.

ADDITIONAL REFRIGERANT CHARGE (R32: g)

Service ref.	Outdoor unit precharged	Refrigerant piping length (one way)			
		7 m	10 m	15 m	20 m
SUZ-M25VA(R1/R2).TH SUZ-M25VA-ET(R2).TH	650	0	60	160	260
SUZ-M35VA(R1/R2).TH SUZ-M35VA-ET(R2).TH	900	0	60	160	260

Calculation: $X_g = 20g/m \times (\text{Refrigerant piping length}(m) - 7)$

Service ref.	Outdoor unit precharged	Refrigerant piping length (one way)					
		7 m	10 m	15 m	20 m	25 m	30 m
SUZ-M50VA(R1/R2).TH SUZ-M50VA-ET(R2).TH	1,200	0	60	160	260	360	460
SUZ-M60VA(R1/R2).TH SUZ-M60VA-ET(R2).TH	1,250	0	60	160	260	360	460

Calculation: $X_g = 20g/m \times (\text{Refrigerant piping length}(m) - 7)$

Service ref.	Outdoor unit precharged	Refrigerant piping length (one way)					
		7 m	10 m	15 m	20 m	25 m	30 m
SUZ-M71VA(R1).TH SUZ-M71VA-ET(R1).TH	1,450	0	120	320	520	720	920

Calculation: $X_g = 40g/m \times (\text{Refrigerant piping length}(m) - 7)$

Pumping Down

When relocating or disposing of the air conditioner, pump down the system by following the procedure below so that no refrigerant is released into the atmosphere.

- ① Turn off the power supply (circuit breaker).
- ② Connect the gauge manifold valve to the service port of the stop valve on the gas pipe side of the outdoor unit.
- ③ Fully close the stop valve on the liquid pipe side of the outdoor unit.
- ④ Supply power (circuit breaker).
- ⑤ Perform the refrigerant collecting operation (cooling test run).
 - For the PAR-4xMAA ("x" represents 0 or later), select "Service" → "Test Run" from the main menu to start the test run, and then select the cooling mode.
 - For details or for other information about starting the test run when using remote controllers, refer to the installation manual for the indoor unit or the remote controller.
- ⑥ Fully close the stop valve on the gas pipe side of the outdoor unit when the pressure gauge shows 0.05 to 0 MPa [Gauge] (approx. 0.5 to 0 kgf/cm²) and quickly stop the air conditioner.
 - Push the "ON/OFF" button on the remote controller to stop the air conditioner.

Note:

When the extension piping is very long with a large refrigerant amount, it may not be possible to perform a pump down operation. In this case, use refrigerant recovery equipment to collect all of the refrigerant in the system.

- ⑦ Turn off the power supply (circuit breaker), remove the gauge manifold valve, and then disconnect the refrigerant pipes.

⚠ Warning: When pumping down the refrigerant, stop the compressor before disconnecting the refrigerant pipes.

- If the refrigerant pipes are disconnected while the compressor is operating and the stop valve (ball valve) is open, the pressure in the refrigeration cycle could become extremely high if air is drawn in, causing the pipes to burst, personal injury, etc.

SUZ-M25VA.TH
 SUZ-M25VAR1.TH
 SUZ-M25VAR2.TH
 SUZ-M25VA-ET.TH
 SUZ-M25VA-ETR2.TH
 SUZ-M60VA.TH
 SUZ-M60VAR1.TH
 SUZ-M60VAR2.TH
 SUZ-M60VA-ET.TH
 SUZ-M60VA-ETR2.TH

SUZ-M35VA.TH
 SUZ-M35VAR1.TH
 SUZ-M35VAR2.TH
 SUZ-M35VA-ET.TH
 SUZ-M35VA-ETR2.TH
 SUZ-M71VA.TH
 SUZ-M71VAR1.TH
 SUZ-M71VA-ET.TH
 SUZ-M71VA-ETR1.TH

SUZ-M50VA.TH
 SUZ-M50VAR1.TH
 SUZ-M50VAR2.TH
 SUZ-M50VA-ET.TH
 SUZ-M50VA-ETR2.TH

9-1. OUTDOOR FAN MOTOR CONTROL

The fan motor turns ON/OFF, interlocking with the compressor.

[ON] The fan motor turns ON 5 seconds before the compressor starts up.

[OFF] The fan motor turns OFF 15 seconds after the compressor has stopped running.

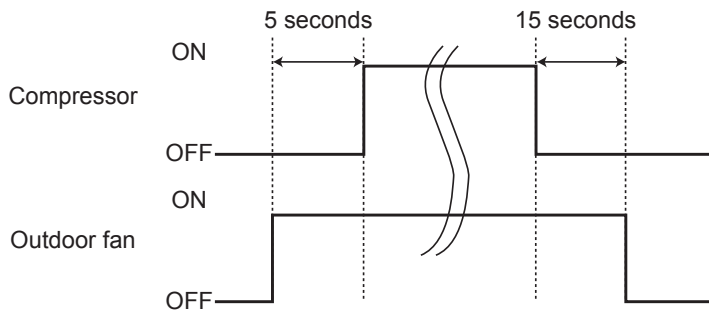

9-2. R.V. COIL CONTROL

Heating ON
 Cooling OFF
 Dry OFF

NOTE: The 4-way valve reverses for 5 seconds right before startup of the compressor.

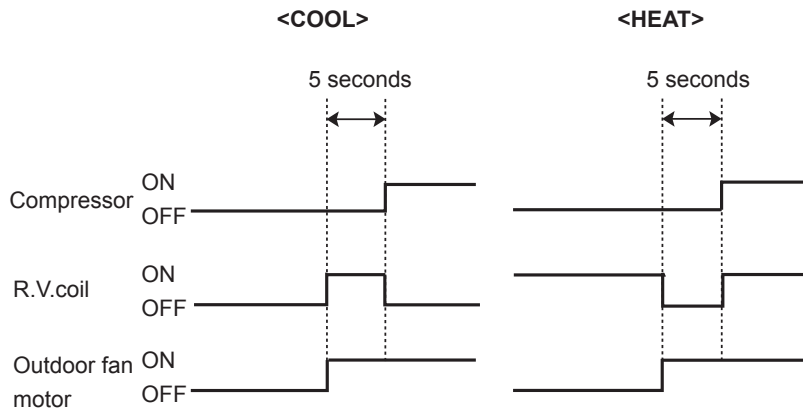

9-3. RELATION BETWEEN MAIN SENSOR AND ACTUATOR

Sensor	Purpose	Actuator				
		Compressor	LEV	Outdoor fan motor	R.V.coil	Indoor fan motor
Discharge temperature thermistor	Protection	○	○			
Indoor coil temperature thermistor	Cooling: Coil frost prevention	○				
	Heating: High pressure protection	○	○			
Defrost thermistor	Heating: Defrosting	○	○	○	○	○
Fin temperature thermistor	Protection	○		○		
Ambient temperature thermistor	Cooling: Low ambient temperature operation	○	○	○		
Outdoor heat exchanger temperature thermistor	Cooling: Low ambient temperature operation	○	○	○		
	Cooling: High pressure protection	○	○	○		

10

SERVICE FUNCTIONS

SUZ-M25VA.TH

SUZ-M25VAR1.TH

SUZ-M25VAR2.TH

SUZ-M25VA-ET.TH

SUZ-M25VA-ETR2.TH

SUZ-M60VA.TH

SUZ-M60VAR1.TH

SUZ-M60VAR2.TH

SUZ-M60VA-ET.TH

SUZ-M60VA-ETR2.TH

SUZ-M35VA.TH

SUZ-M35VAR1.TH

SUZ-M35VAR2.TH

SUZ-M35VA-ET.TH

SUZ-M35VA-ETR2.TH

SUZ-M71VA.TH

SUZ-M71VAR1.TH

SUZ-M71VA-ET.TH

SUZ-M71VA-ETR1.TH

SUZ-M50VA.TH

SUZ-M50VAR1.TH

SUZ-M50VAR2.TH

SUZ-M50VA-ET.TH

SUZ-M50VA-ETR2.TH

CHANGE IN DEFROST SETTING

Changing defrost finish temperature

<JS> To change the defrost finish temperature, cut/solder the JS wire of the outdoor inverter P.C. board. (Refer to "11-6-1. Inverter P.C. board".)

Jumper wire		Defrost finish temperature (°C)			
		SUZ-M25	SUZ-M35	SUZ-M50	SUZ-M60 SUZ-M71
JS	Soldered (Initial setting)	5	9	9	10
	None (cut)	8	13	18	18

11

TROUBLESHOOTING

SUZ-M25VA.TH

SUZ-M25VAR1.TH

SUZ-M25VAR2.TH

SUZ-M25VA-ET.TH

SUZ-M25VA-ETR2.TH

SUZ-M60VA.TH

SUZ-M60VAR1.TH

SUZ-M60VAR2.TH

SUZ-M60VA-ET.TH

SUZ-M60VA-ETR2.TH

SUZ-M35VA.TH

SUZ-M35VAR1.TH

SUZ-M35VAR2.TH

SUZ-M35VA-ET.TH

SUZ-M35VA-ETR2.TH

SUZ-M71VA.TH

SUZ-M71VAR1.TH

SUZ-M71VA-ET.TH

SUZ-M71VA-ETR1.TH

SUZ-M50VA.TH

SUZ-M50VAR1.TH

SUZ-M50VAR2.TH

SUZ-M50VA-ET.TH

SUZ-M50VA-ETR2.TH

11-1. CAUTIONS ON TROUBLESHOOTING

1. Before troubleshooting, check the following items:

- 1) Check the power supply voltage.
- 2) Check the indoor/outdoor connecting wire for miswiring.

2. Take care of the following during servicing.

- 1) Before servicing the air conditioner, be sure to turn OFF the main unit first with the remote controller, and turn off the breaker.
- 2) Be sure to turn OFF the power supply before removing the front panel, the cabinet, the top panel, and the electronic control P.C. board.
- 3) When removing the electrical parts, be careful of the residual voltage of smoothing capacitor.
- 4) When removing the electronic control P.C. board, hold the edge of the board with care NOT to apply stress on the components.
- 5) When connecting or disconnecting the connectors, hold the housing of the connector. DO NOT pull the lead wires.

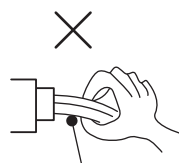

Lead wire

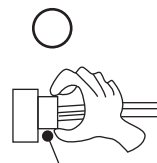

Housing point

3. Troubleshooting procedure

- 1) Check if the OPERATION INDICATOR lamp on the outdoor P.C. board is blinking on and off to indicate an abnormality. To make sure, check how many times the abnormality indication is blinking on and off before starting service work.
- 2) Before servicing check that the connector and terminal are connected properly.
- 3) If the electronic control P.C. board is supposed to be defective, check the copper foil pattern for disconnection and the components for bursting and discoloration.
- 4) When troubleshooting, refer to "11-2. TROUBLESHOOTING CHECK TABLE" and "11-3. HOW TO PROCEED "SELF-DIAGNOSIS"".

11-2. TROUBLESHOOTING CHECK TABLE

No.	Symptoms	LED indication	check code	Abnormal point/Condition	Condition	Remedy
1	Outdoor unit does not operate.	1-time blink every 2.5 seconds	UP	Outdoor power system	Overcurrent protection cut-out operates 3 consecutive times within 1 minute after the compressor gets started.	•Reconnect connector of compressor. •Refer to 11-5. Ⓐ "How to check inverter/compressor". •Check stop valve.
2			U3	Outdoor thermistors	Discharge temperature thermistor shorts, or opens during compressor running.	•Refer to 11-5. Ⓔ "Check of outdoor thermistors".
			U4	Fin temperature thermistor, defrost thermistor, P.C. board temperature thermistor, outdoor heat exchanger temperature thermistor or ambient temperature thermistor shorts, or opens during compressor running.		
3			FC	Outdoor control system	Nonvolatile memory data cannot be read properly.	•Replace inverter P.C. board.
4		6-time blink every 2.5 seconds OFF	E8 / E9	Serial signal	The communication fails between the indoor and outdoor unit for 3 minutes.	•Check of indoor/outdoor connecting wire •Replace indoor or outdoor P.C. board if abnormality is displayed again.
5		11-time blink every 2.5 seconds OFF	UE	Stop valve/ Closed valve	Closed valve is detected by compressor current.	• Check stop valve.
6		16-time blink every 2.5 seconds OFF	PL	Outdoor refrigerant system abnormality	A closed valve and air trapped in the refrigerant circuit are detected based on the temperature sensed by the indoor and outdoor thermistors and the current of the compressor.	• Check for a gas leak in a connecting piping, etc. • Check stop valve. •Refer to 11-5. Ⓚ "Check of outdoor refrigerant circuit".
	7					20-time blink every 2.5 seconds OFF
8	'Outdoor unit stops and restarts 3 minutes later' is repeated.	2-time blink every 2.5 seconds OFF	OFF	Overcurrent protection	Large current flows into intelligent power module.	•Reconnect connector of compressor. •Refer to 11-5. Ⓐ "How to check inverter/compressor". •Check stop valve.
9		3-time blink every 2.5 seconds OFF	OFF	Discharge temperature overheat protection	Temperature of discharge temperature thermistor exceeds 116°C, compressor stops. Compressor can restart if discharge temperature thermistor reads 100°C or less 3 minutes later.	•Check refrigerant circuit and refrigerant amount. •Refer to 11-5. Ⓚ "Check of LEV".
10		4-time blink every 2.5 seconds OFF	OFF	Fin temperature /P.C. board temperature thermistor overheat protection	Temperature of fin temperature thermistor on the heat sink exceeds 72 to 86°C or temperature of P.C. board temperature thermistor on the inverter P.C. board exceeds 72 to 85°C.	•Check around outdoor unit. •Check outdoor unit air passage. •Refer to 11-5. Ⓚ "Check of outdoor fan motor".
11		5-time blink every 2.5 seconds OFF	OFF	High pressure protection	Indoor coil thermistor exceeds 70°C in HEAT mode. Defrost thermistor exceeds 70°C in COOL mode.	•Check refrigerant circuit and refrigerant amount. •Check stop valve.
12		8-time blink every 2.5 seconds OFF	OFF	Compressor synchronous abnormality	The waveform of compressor current is distorted.	•Reconnect connector of compressor. •Refer to 11-5. Ⓐ "How to check inverter/compressor".
13		10-time blink every 2.5 seconds OFF	OFF	Outdoor fan motor	Outdoor fan has stopped 3 times in a row within 30 seconds after outdoor fan startup.	•Refer to 11-5. Ⓚ "Check of outdoor fan motor." •Refer to 11-5. Ⓚ "Check of inverter P.C. board."
14		12-time blink every 2.5 seconds OFF	OFF	Each phase current of compressor	Each phase current of compressor cannot be detected normally.	•Refer to 11-5. Ⓐ "How to check inverter/compressor".
15		13-time blink every 2.5 seconds OFF	OFF	DC voltage	DC voltage of inverter cannot be detected normally.	•Refer to 11-5. Ⓐ "How to check inverter/compressor".
16		Outdoor unit operates.	1-time blink every 2.5 seconds OFF	OFF	Frequency drop by current protection	When the input current exceeds approximately 7A(M25) / 8A(M35)/12A(M50)/14A(M60)/16A(M71), compressor frequency lowers.
17	3-time blink every 2.5 seconds OFF		OFF	Frequency drop by high pressure protection	Temperature of indoor coil thermistor exceeds 55°C in HEAT mode, compressor frequency lowers.	
				Frequency drop by defrosting in COOL mode	Indoor coil thermistor reads 8°C or less in COOL mode, compressor frequency lowers.	
18	4-time blink every 2.5 seconds OFF		OFF	Frequency drop by discharge temperature protection	Temperature of discharge temperature thermistor exceeds 111°C, compressor frequency lowers.	•Check refrigerant circuit and refrigerant amount. •Refer to 11-5. Ⓚ "Check of LEV". •Refer to 11-5. Ⓔ "Check of outdoor thermistors".
19	7-time blink every 2.5 seconds OFF		OFF	Low discharge temperature protection	Temperature of discharge temperature thermistor has been 50°C or less for 20 minutes.	•Refer to 11-5. Ⓚ "Check of LEV". •Check refrigerant circuit and refrigerant amount.
20	8-time blink every 2.5 seconds OFF	OFF	(M25/35/50) PAM protection PAM: Pulse Amplitude Modulation	The overcurrent flows into PFC (Power factor correction: IC820) or the bus-bar voltage reaches 394 V or more, PAM stops and restarts.	This is not malfunction. PAM protection will be activated in the following cases: 1. Instantaneous power voltage drop. (Short time power failure) 2. When the power supply voltage is high.	
			(M60/71) Zero cross detecting circuit	Zero cross signal for PAM control cannot be detected.		
21	9-time blink every 2.5 seconds OFF	OFF	Inverter check mode	The connector of compressor is disconnected, inverter check mode starts.	• Check if the connector of the compressor is correctly connected. •Refer to 11-5. Ⓐ "How to check inverter/compressor".	

Notes: 1. The location of LED is illustrated at the right figure. Refer to "11-6. Test point diagram and voltage".

2. LED is lighted during normal operation.

The blinking frequency shows the number of times the LED blinks after every 2.5-second OFF.
(Example) When the blinking frequency is "2".

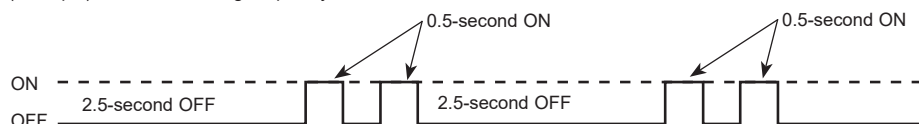

Inverter P.C. board

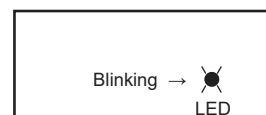

11-3. HOW TO PROCEED "SELF-DIAGNOSIS"

11-3-1. Self-diagnosis <PAR-4xMAA ("x" represents 0 or later)>

- ① Select "Service" from the Main menu, and press the [✓] button.

Select "Check" from the Service menu, and press the [✓] button.

Select "Diagnosis" from the Check menu, and press the [✓] button.

Select "Self check" with the [F1] or [F2] button, and press the [✓] button.

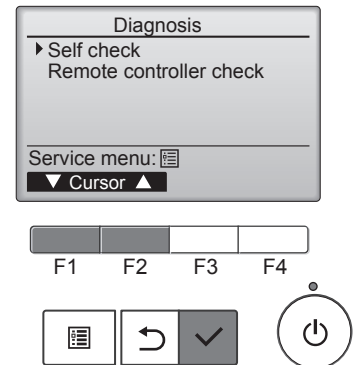

- ② With the [F1] or [F2] button, enter the refrigerant address, and press the [✓] button.

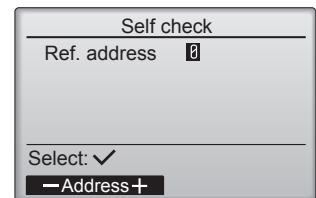

- ③ Check code, unit number, attribute will appear. "-" will appear if no error history is available.

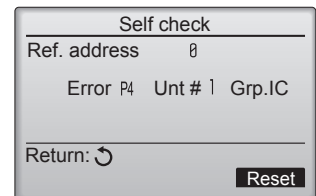

When there is no error history

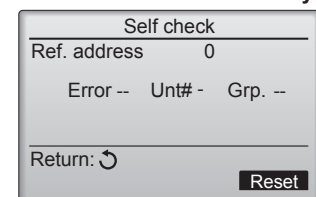

- ④ Resetting the error history

Press the [F4] button (Reset) on the screen that shows the error history.

A confirmation screen will appear asking if you want to delete the error history.

Press the [F4] button (OK) to delete the error history.

If deletion fails, "Request rejected" will appear. "Unit not exist" will appear if no indoor units that correspond to the entered address are found.

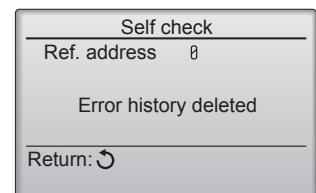
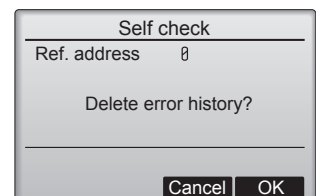

Navigating through the screens

- To go back to the Service menu [☰] button
- To return to the previous screen..... [↻] button

11-3-2. Remote controller check <PAR-4xMAA ("x" represents 0 or later)>

If operations cannot be completed with the remote controller, diagnose the remote controller with this function.

- ① Select "Service" from the Main menu, and press the [✓] button.



Select "Check" from the Service menu, and press the [✓] button.



Select "Diagnosis" from the Check menu, and press the [✓] button.



Select "Remote controller check" with the [F1] or [F2] button, and press the [✓] button.

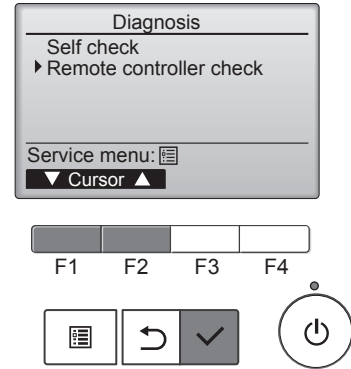

- ② Select "Remote controller check" from the Diagnosis menu and press the [✓] button to start the remote controller check and see the check results.



To cancel the remote controller check and exit the "Remote controller check" menu screen, press the [⏏] or the [↺] button.



The remote controller will not reboot itself.

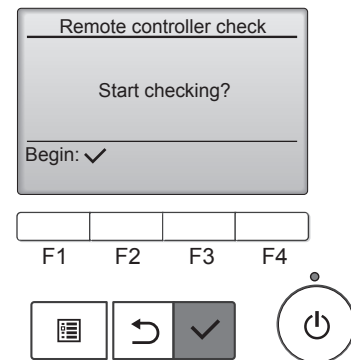

- ③
- OK: No problems are found with the remote controller. Check other parts for problems.
 - E3, 6832: There is noise on the transmission line, or the indoor unit or another remote controller is faulty. Check the transmission line and the other remote controllers.
 - NG (ALLO, ALL1): Send-receive circuit fault. The remote controller needs replacing.
 - ERC: The number of data errors is the discrepancy between the number of bits in the data transmitted from the remote controller and that of the data that was actually transmitted over the transmission line. If data errors are found, check the transmission line for external noise interference.



If the [✓] button is pressed after the remote controller check results are displayed, remote controller check will end, and the remote controller will automatically reboot itself.

Remote controller check results screen

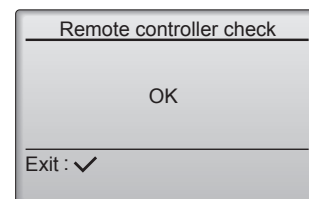



Check the remote controller display and see if anything is displayed (including lines). Nothing will appear on the remote controller display if the correct voltage (8.5–12 V DC) is not supplied to the remote controller. If this is the case, check the remote controller wiring and indoor units.



11-3-3. Self-diagnosis <PAC-YT52CRA>

Retrieve the error history of each unit using the Simple MA controller.

- ① Switch to the self-diagnosis mode.

When the (A)  button and the (C)  button are pressed for 5 seconds or longer, the figure shown below is displayed.

- ② Set the address or refrigerant address No. you want to self-diagnosis.

When the (B)  and (C)  are pressed, the address decreases and increases between 01 and 50 or 00 and 15. Set it to the address No. or refrigerant address No. you want to self-diagnosis.

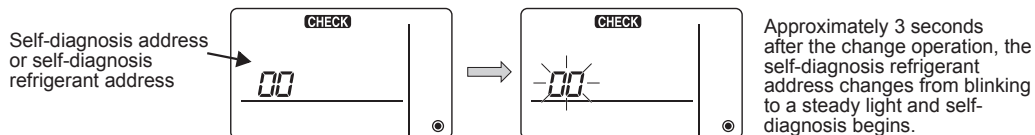

- ③ Self-diagnosis result display <error history>

(For the contents of the check code, refer to the indoor unit installation manual or service handbook.)

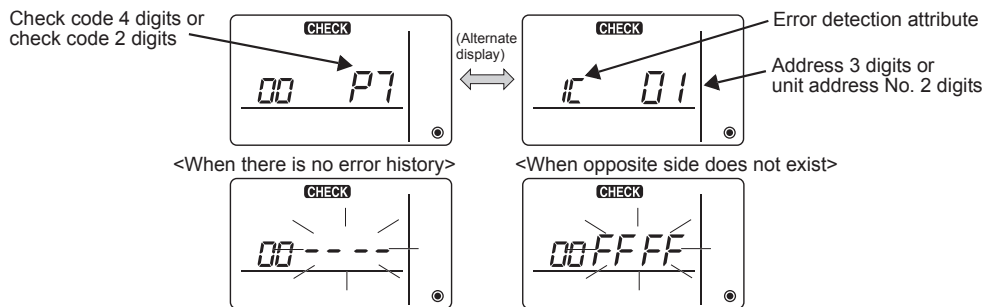

- ④ Error history reset

The error history is displayed in ③ self-diagnosis results display.

When the (D)  button is pressed 2 times successively within 3 seconds, the self-diagnosis object address and refrigerant address blink.

When the error history was reset, the display shown below appears.

When error history reset is failed, the error contents are displayed again.

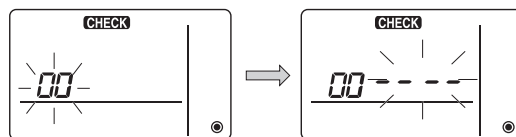

- ⑤ Self-diagnosis reset

There are the following 2 ways of resetting self-diagnosis.

Press the (A)  button and the (C)  button simultaneously for 5 seconds or longer.

→ Resets self-diagnosis and returns to the state before self-diagnosis.

Press the (A)  button. → Self-diagnosis resets and indoor units stop.

(When operation is prohibited, this operation is ineffective.)

11-3-4. Remote Controller Check <PAC-YT52CRA>

When the air conditioner cannot be controlled from the Simple MA controller, use this function to check the remote controller.

- First, check the power mark.
When normal voltage (12 V DC) is not applied to the remote controller, the power mark goes off.
When the power mark is off, check the remote controller wiring and the indoor unit.

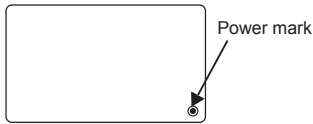

- Switch to the remote controller check mode.
When the **TEMP** button and the **RC** button are pressed simultaneously for 5 seconds or longer, the figure shown below is displayed.
When the **ON/OFF** button is pressed, remote controller check begins.

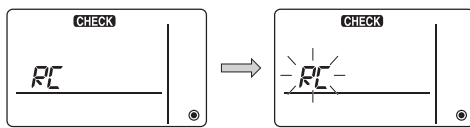

- Remote controller check result
<When remote controller is normal>

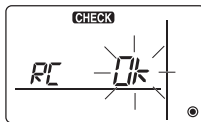

Since there is no problem at the remote controller, check for other causes.

(Error display 1) "NG" blinks → Remote controller sends/receives circuit abnormal

<When remote controller is faulty>

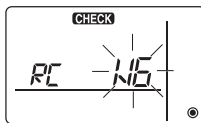

Remote controller switching is necessary.

When the problem is other than the checked remote controller



(Error display 2) "E3" "6833" "6832" blink → Cannot send

There is noise on the transmission line, or the indoor unit or another remote controller is faulty. Check the transmission line and the other remote controllers.

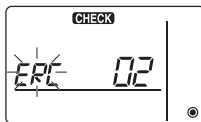

(Error display 3) "ERC" and data error count are displayed → Data error generation

"Data error count" is the difference between the number of bits of remote controller send data and the number of bits actually sent to the transmission line. In this case, the send data was disturbed by the noise, etc. Check the transmission line.

When data error count is 02

Remote controller send data
Send data on transmission line

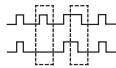

- Remote controller check reset
When the **TEMP** button and the **RC** button are pressed simultaneously for 5 seconds or longer, remote controller diagnosis is reset, the [HO] and run lamp blink for a certain period of time, and then the remote controller returns to its state before diagnosis.

11-3-5. Self-diagnosis <Wireless remote controller>

*For SLZ model, refer to the indoor unit's service manual.

<In the case of trouble during operation, except for SLZ model*>

When a malfunction occurs to air conditioner, both indoor unit and outdoor unit will stop and operation lamp blinks to inform unusual stop.

<Malfunction-diagnosis method at maintenance service>

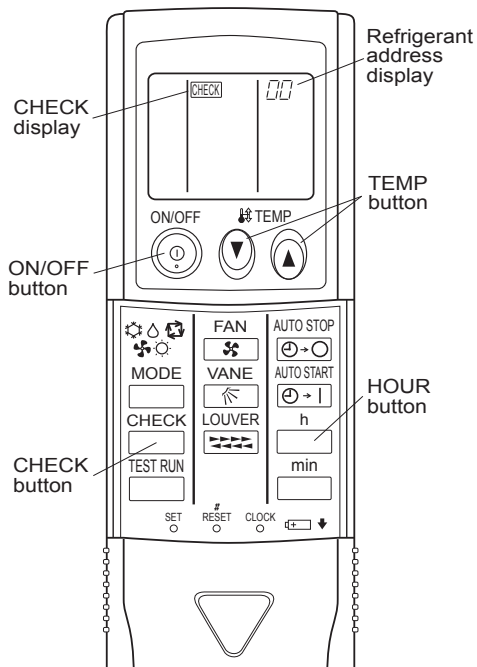

[Procedure]

1. Press the CHECK button twice.
 - "CHECK" lights, and refrigerant address "00" blinks.
 - Check that the remote controller's display has stopped before continuing.
2. Press the TEMP buttons.
 - Select the refrigerant address of the indoor unit for the self-diagnosis.
Note: Set refrigerant address using the outdoor unit's DIP switch (SW1).
(For more information, see the outdoor unit installation manual.)
3. Point the remote controller at the sensor on the indoor unit and press the HOUR button.
 - If an air conditioner error occurs, the indoor unit's sensor emits an intermittent buzzer sound, the operation light blinks, and the check code is output.
(It takes 3 seconds at most for check code to appear.)
4. Point the remote controller at the sensor on the indoor unit and press the ON/OFF button.
 - The check mode is cancelled.

• Refer to the following tables for details on the check codes.

[Output pattern A]

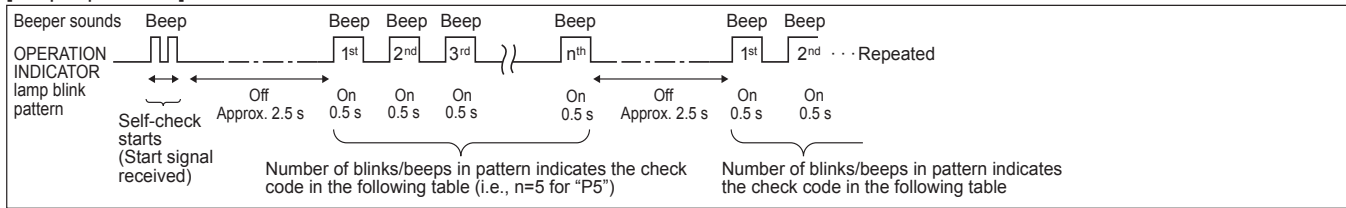

[Output pattern B]

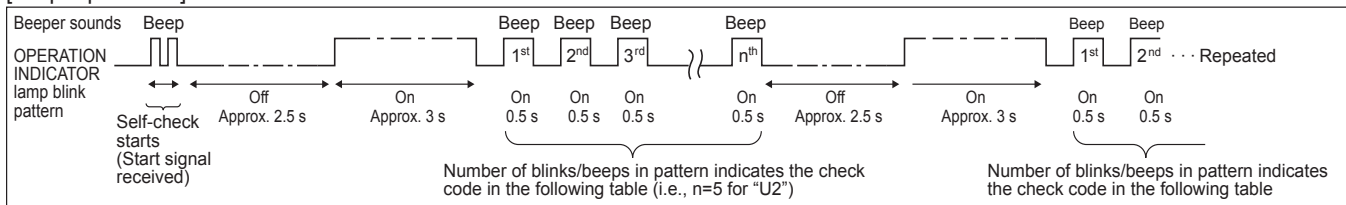

[Output pattern A] Errors detected by indoor unit

Wireless remote controller	Wired remote controller	Symptom	Remark
Beeper sounds/OPERATION INDICATOR lamp blinks (Number of times)	Check code		
1	P1	Intake sensor error	As for indoor unit, refer to indoor unit's service manual.
2	P2	Pipe (TH2) sensor error	
	P9	Pipe (TH5) sensor error	
3	E6,E7	Indoor/outdoor unit communication error	
4	P4	Drain sensor error/Float switch connector (CN4F) open	
5	P5	Drain pump error	
	PA	Forced compressor stop (due to water leakage abnormality)	
6	P6	Freezing/Overheating protection operation	
7	EE	Combination error between indoor and outdoor units	
9	E4,E5	Remote controller signal receiving error	
12	Fb (FB)*	Indoor unit control system error (memory error, etc.)	
14	PL	Abnormality of refrigerant circuit	
-	E0,E3	Remote controller transmission error	
-	E1,E2	Remote controller control board error	

[Output pattern B] Errors detected by unit other than indoor unit (outdoor unit, etc.)

Wireless remote controller	Wired remote controller	Symptom
Beeper sounds/OPERATION INDICATOR lamp blinks (Number of times)	Check code	
1	E9	Indoor/outdoor unit communication error (Transmitting error) (Outdoor unit)
2	UP	Compressor overcurrent interruption
3	U3,U4	Open/short of outdoor unit thermistors
14	PL or Others	Abnormality of refrigerant circuit or other errors (Refer to the technical manual for the outdoor unit.)

- Notes: 1. If the beeper does not sound again after the initial 2 beeps to confirm the self-check start signal was received and the OPERATION INDICATOR lamp does not come on, there are no error records.
 2. If the beeper sounds 3 times continuously "beep, beep, beep (0.4 + 0.4 + 0.4 second)" after the initial 2 beeps to confirm the self-check start signal was received, the specified refrigerant address is incorrect.

*The check code in the parenthesis indicates PAR-4xMAA model. ("x" represents 0 or later).

11-4. TROUBLE CRITERION OF MAIN PARTS

SUZ-M25VA.TH
 SUZ-M25VAR1.TH
 SUZ-M25VAR2.TH
 SUZ-M25VA-ET.TH
 SUZ-M25VA-ETR2.TH
 SUZ-M60VA.TH
 SUZ-M60VAR1.TH
 SUZ-M60VAR2.TH
 SUZ-M60VA-ET.TH
 SUZ-M60VA-ETR2.TH

SUZ-M35VA.TH
 SUZ-M35VAR1.TH
 SUZ-M35VAR2.TH
 SUZ-M35VA-ET.TH
 SUZ-M35VA-ETR2.TH
 SUZ-M71VA.TH
 SUZ-M71VAR1.TH
 SUZ-M71VA-ET.TH
 SUZ-M71VA-ETR1.TH

SUZ-M50VA.TH
 SUZ-M50VAR1.TH
 SUZ-M50VAR2.TH
 SUZ-M50VA-ET.TH
 SUZ-M50VA-ETR2.TH

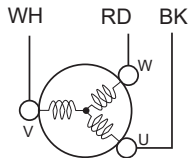
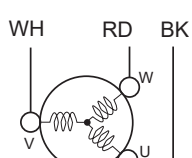
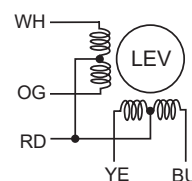
Parts name	Check method and criterion	Figure																									
Defrost thermistor (RT61) Fin temperature thermistor (RT64) Ambient temperature thermistor (RT65) Outdoor heat exchanger temperature thermistor(RT68)	Measure the resistance with a tester. Refer to "11-6. Test point diagram and voltage", 11-6-1. (M25/35/50) or 11-6-2. (M60/71) "Inverter P.C. board", for the chart of thermistor.	/																									
Discharge temperature thermistor (RT62)	Measure the resistance with a tester. Before measurement, hold the thermistor with your hands to warm it up. Refer to "11-6. Test point diagram and voltage", 11-6-1. (M25/35/50) or 11-6-2. (M60/71) "Inverter P.C. board", for the chart of thermistor.	/																									
Compressor	Measure the resistance between terminals with a tester. (Temperature: -10 to 40°C) <table border="1" style="margin-top: 10px;"> <thead> <tr> <th></th> <th colspan="4">Normal</th> </tr> <tr> <th></th> <th>SUZ-M25</th> <th>SUZ-M35</th> <th>SUZ-M50/60</th> <th>SUZ-M71</th> </tr> </thead> <tbody> <tr> <td>U-V</td> <td></td> <td></td> <td></td> <td></td> </tr> <tr> <td>U-W</td> <td>1.59 to 2.16Ω</td> <td>1.60 to 2.17 Ω</td> <td>0.82 to 1.11 Ω</td> <td>0.87 to 1.18 Ω</td> </tr> <tr> <td>V-W</td> <td></td> <td></td> <td></td> <td></td> </tr> </tbody> </table>		Normal					SUZ-M25	SUZ-M35	SUZ-M50/60	SUZ-M71	U-V					U-W	1.59 to 2.16Ω	1.60 to 2.17 Ω	0.82 to 1.11 Ω	0.87 to 1.18 Ω	V-W					
	Normal																										
	SUZ-M25	SUZ-M35	SUZ-M50/60	SUZ-M71																							
U-V																											
U-W	1.59 to 2.16Ω	1.60 to 2.17 Ω	0.82 to 1.11 Ω	0.87 to 1.18 Ω																							
V-W																											
Outdoor fan motor	Measure the resistance between terminals with a tester. (Temperature: -10 to 40°C) <table border="1" style="margin-top: 10px;"> <thead> <tr> <th>Color of the lead wire</th> <th colspan="3">Normal</th> </tr> <tr> <th></th> <th>SUZ-M25/35</th> <th>SUZ-M50</th> <th>SUZ-M60/71</th> </tr> </thead> <tbody> <tr> <td>WH - BK</td> <td></td> <td></td> <td></td> </tr> <tr> <td>BK - RD</td> <td>32 to 43 Ω</td> <td>15 to 20 Ω</td> <td>25 to 34 Ω</td> </tr> <tr> <td>RD - WH</td> <td></td> <td></td> <td></td> </tr> </tbody> </table>	Color of the lead wire	Normal				SUZ-M25/35	SUZ-M50	SUZ-M60/71	WH - BK				BK - RD	32 to 43 Ω	15 to 20 Ω	25 to 34 Ω	RD - WH									
Color of the lead wire	Normal																										
	SUZ-M25/35	SUZ-M50	SUZ-M60/71																								
WH - BK																											
BK - RD	32 to 43 Ω	15 to 20 Ω	25 to 34 Ω																								
RD - WH																											
R.V. coil (21S4)	Measure the resistance between terminals with a tester. (Temperature: -10 to 40°C) <table border="1" style="margin-top: 10px;"> <thead> <tr> <th colspan="2">Normal</th> </tr> <tr> <th>SUZ-M25/35/50</th> <th>SUZ-M60/71</th> </tr> </thead> <tbody> <tr> <td>1.41 to 2.00 kΩ</td> <td>1.17 to 1.66 kΩ</td> </tr> </tbody> </table>	Normal		SUZ-M25/35/50	SUZ-M60/71	1.41 to 2.00 kΩ	1.17 to 1.66 kΩ	/																			
Normal																											
SUZ-M25/35/50	SUZ-M60/71																										
1.41 to 2.00 kΩ	1.17 to 1.66 kΩ																										
Expansion valve coil (LEV)	Measure the resistance with a tester. (Temperature: -10 to 40°C) <table border="1" style="margin-top: 10px;"> <thead> <tr> <th>Color of the lead wire</th> <th>Normal</th> </tr> </thead> <tbody> <tr> <td>RD - OG</td> <td rowspan="4" style="text-align: center;">37 to 54 Ω</td> </tr> <tr> <td>RD - WH</td> </tr> <tr> <td>RD - BU</td> </tr> <tr> <td>RD - YE</td> </tr> </tbody> </table>	Color of the lead wire	Normal	RD - OG	37 to 54 Ω	RD - WH	RD - BU	RD - YE																			
Color of the lead wire	Normal																										
RD - OG	37 to 54 Ω																										
RD - WH																											
RD - BU																											
RD - YE																											

11-5. TROUBLESHOOTING FLOW

A How to check inverter/compressor

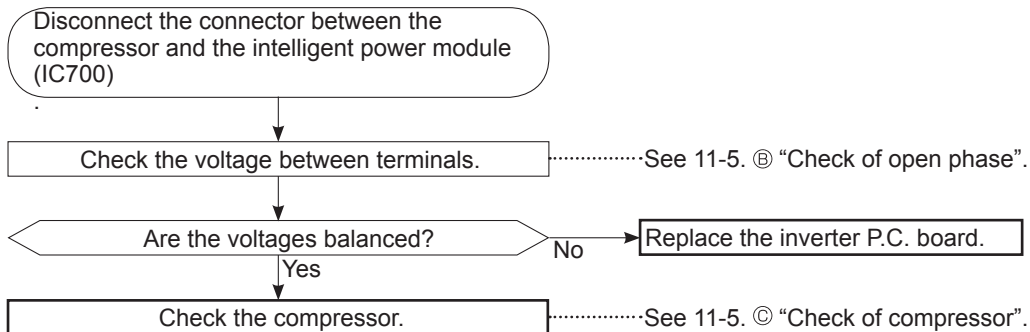

B Check of open phase

- With the connector between the compressor and the intelligent power module disconnected, activate the inverter and check if the inverter is normal by measuring **the voltage balance** between the terminals.

Output voltage is 50–130 V. (The voltage may differ according to the tester.)

< Operation method (Test run operation)>

- For the PAR-4xMAA model. ("x" represents 0 or later), select "Service" → "Test Run" from the main menu to start the test run, and then select the cooling mode.
- For details or for other information about starting the test run when using remote controllers, refer to the installation manual for the indoor unit or the remote controller.

<Measurement point>

At 3 points

BK (U) - WH (V)

BK (U) - RD (W)

WH (V) - RD (W)

Measure AC voltage between the lead wires at 3 points.

NOTE: 1. Output voltage varies according to power supply voltage.

2. Measure the voltage by analog type tester.

3. During this check, LED of the inverter P.C. board blinks 9 times. (M25/35/50: Refer to 11-6-1, M60/71: 11-6-2)

C Check of compressor

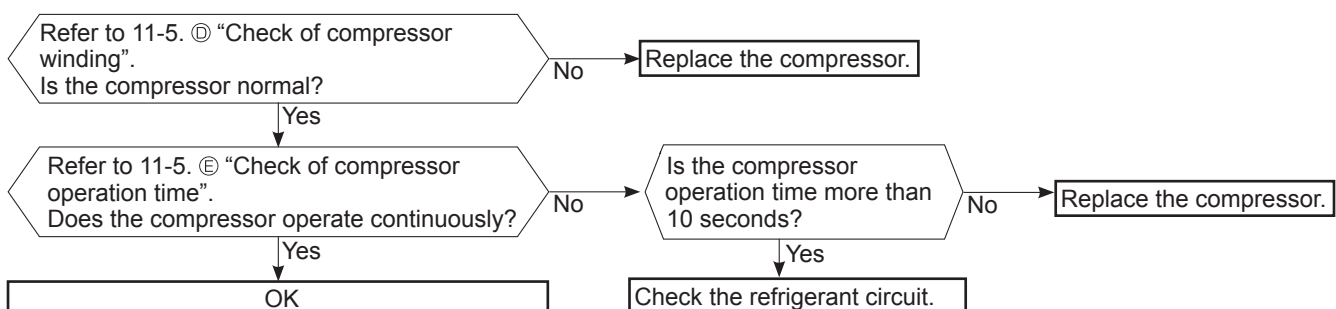

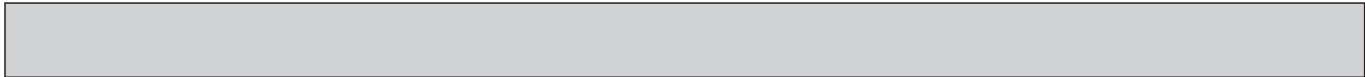

D Check of compressor winding

- Disconnect the connector between the compressor and the intelligent power module, and measure the resistance between the compressor terminals.

<Measurement point>

Measure the resistance between the lead wires at 3 points.

BK-WH

BK-RD

WH-RD

<Judgement>

Refer to "11-4. TROUBLE CRITERION OF MAIN PARTS".

0 [Ω]Abnormal [short]

Infinite [Ω]Abnormal [open]

NOTE: Be sure to zero the ohmmeter before measurement.

E Check of compressor operation time

- Connect the compressor and activate the inverter. Then measure the time until the inverter stops due to overcurrent.

<Operation method>

Start heating or cooling test run.

(TEST RUN OPERATION : Refer to 11-5 ⑥.)

<Measurement>

Measure the time from the start of compressor to the stop of compressor due to overcurrent.

<<Judgement>>

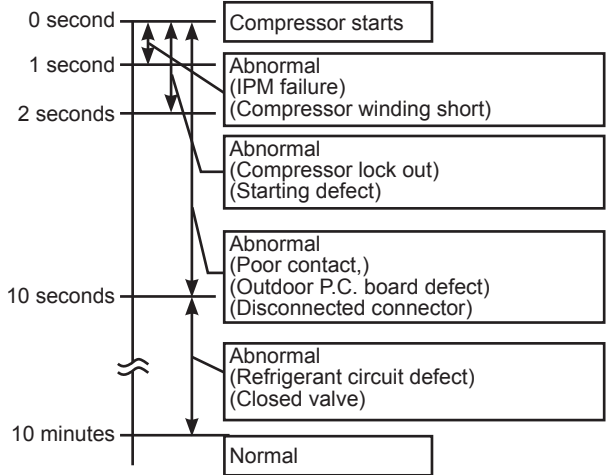

F Check of outdoor thermistors

Disconnect the connector of thermistor in the outdoor P.C. board (see below table), and measure the resistance of thermistor.

Is the resistance of thermistor normal?

(M25/35/50: Refer to 11-6-1, M60/71: 11-6-2.)

No

Replace the thermistor except RT64. When RT64 is abnormal, replace the inverter P.C. board.

Yes

Reconnect the connector of thermistor. Turn ON the power supply and press EMERGENCY OPERATION switch.

Does the unit operate for 10 minutes or more without showing thermistor abnormality?

No

Replace the inverter P.C. board.

Yes

OK
(Cause is poor contact.)

Thermistor	Symbol	Connector, Pin No.		Board
		SUZ-M25/35/50	SUZ-M60/71	
Defrost	RT61	Between CN641 pin1 and pin2	Between CN671 pin1 and pin2	Inverter P.C. board
Discharge temperature	RT62	Between CN641 pin3 and pin4	Between CN671 pin3 and pin4	
Fin temperature	RT64	Between CN642 pin1 and pin2	Between CN673 pin1 and pin2	
Ambient temperature	RT65	Between CN643 pin1 and pin2	Between CN672 pin1 and pin2	
Outdoor heat exchanger temperature	RT68	Between CN644 pin1 and pin3	Between CN671 pin5 and pin6	

G Check of R.V. coil

- First of all, measure the resistance of R.V. coil to check if the coil is defective. Refer to "11-4. TROUBLE CRITERION OF MAIN PARTS".

In case CN721(M25/35/50)/CN602(M60/71) is not connected or R.V. coil is open, voltage is generated between the terminal pins of the connector although any signal is not being transmitted to R.V. coil.

Check if CN721(M25/35/50)/CN602(M60/71) is connected.

Unit operates in COOL mode even if it is set to HEAT mode.

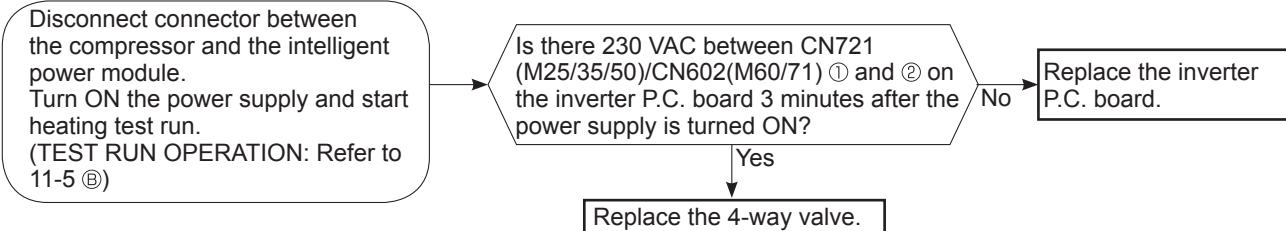

Unit operates in HEAT mode even if it is set to COOL mode.

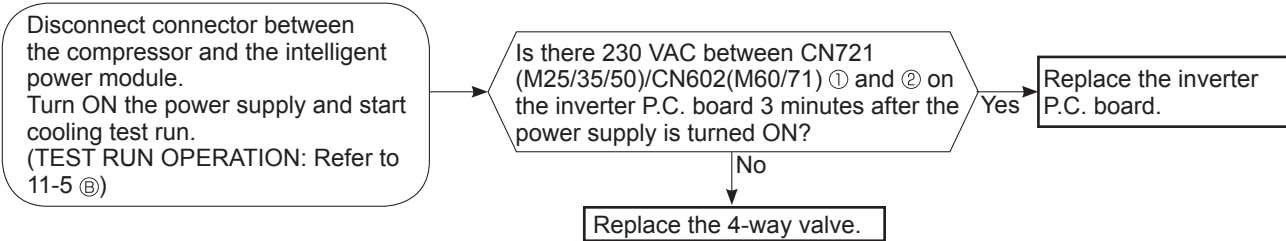

H Check of outdoor fan motor

Disconnect the connectors CN931 and CN932 from the inverter P.C. board. Check the connection between the connector CN931 and CN932.

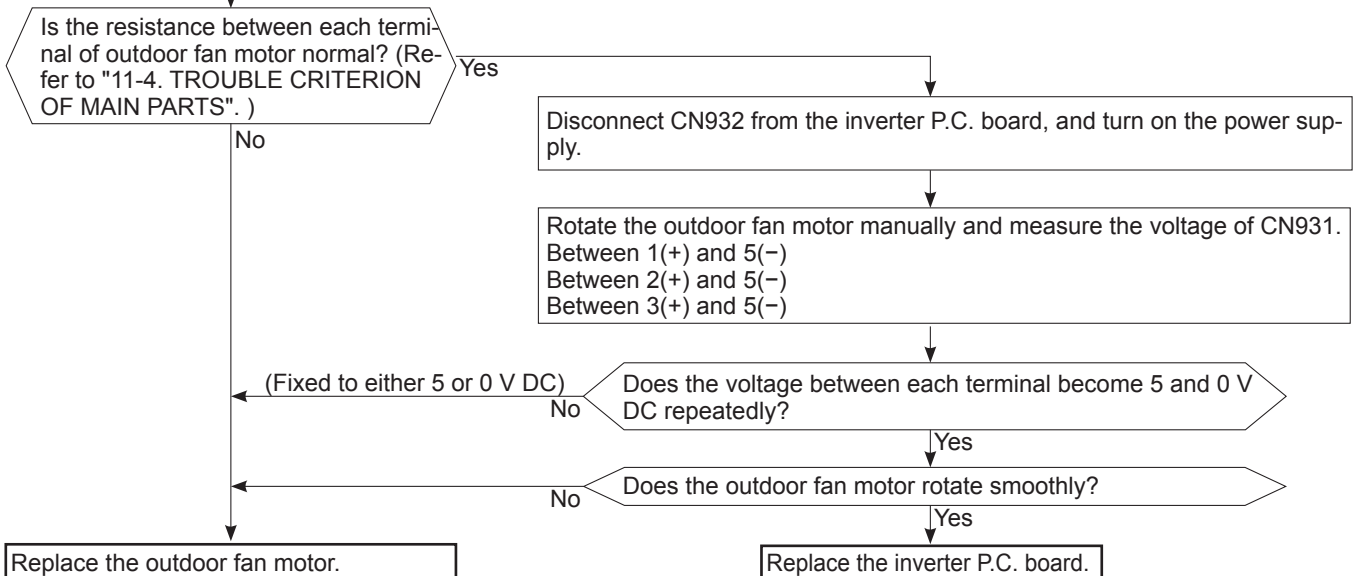

① Check of LEV

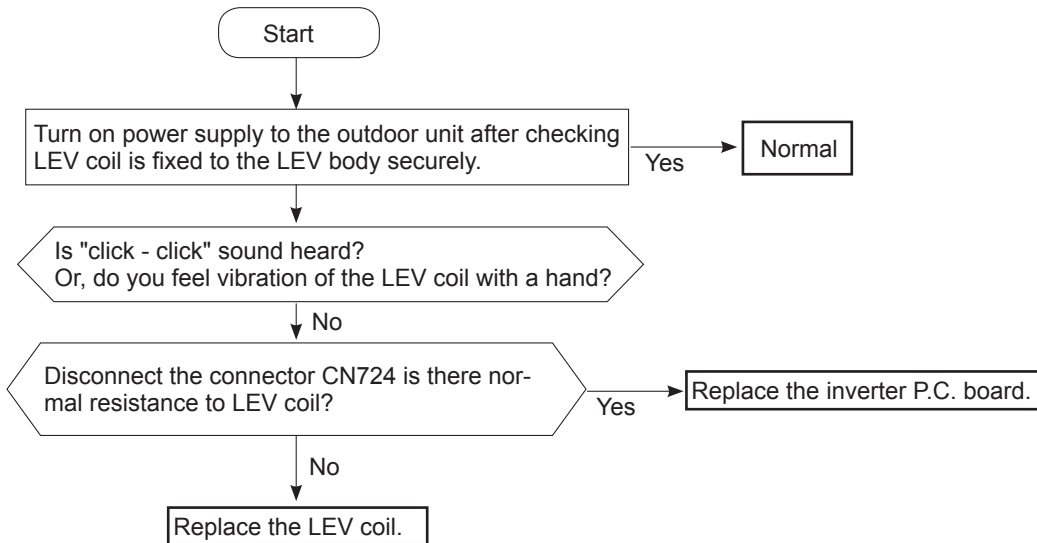

② Check of inverter P.C. board

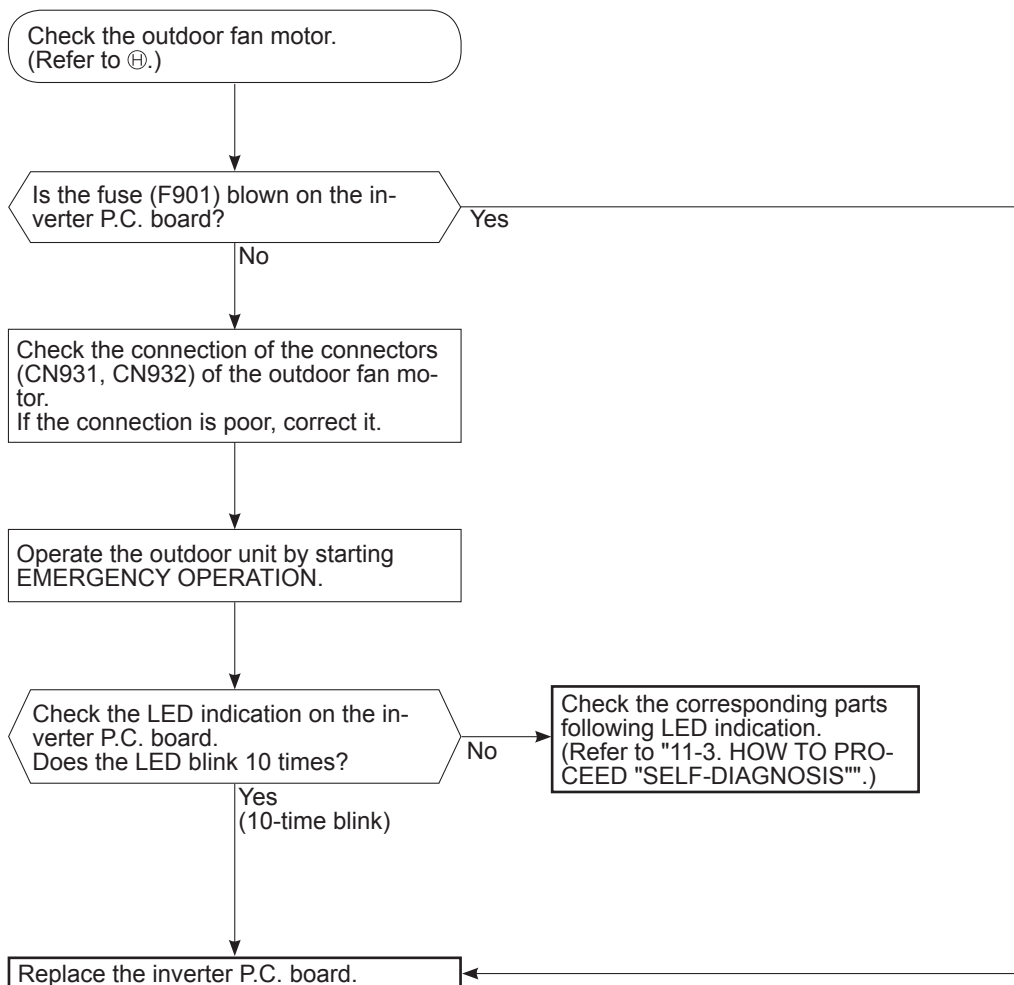

K Electromagnetic noise enters into TV sets or radios

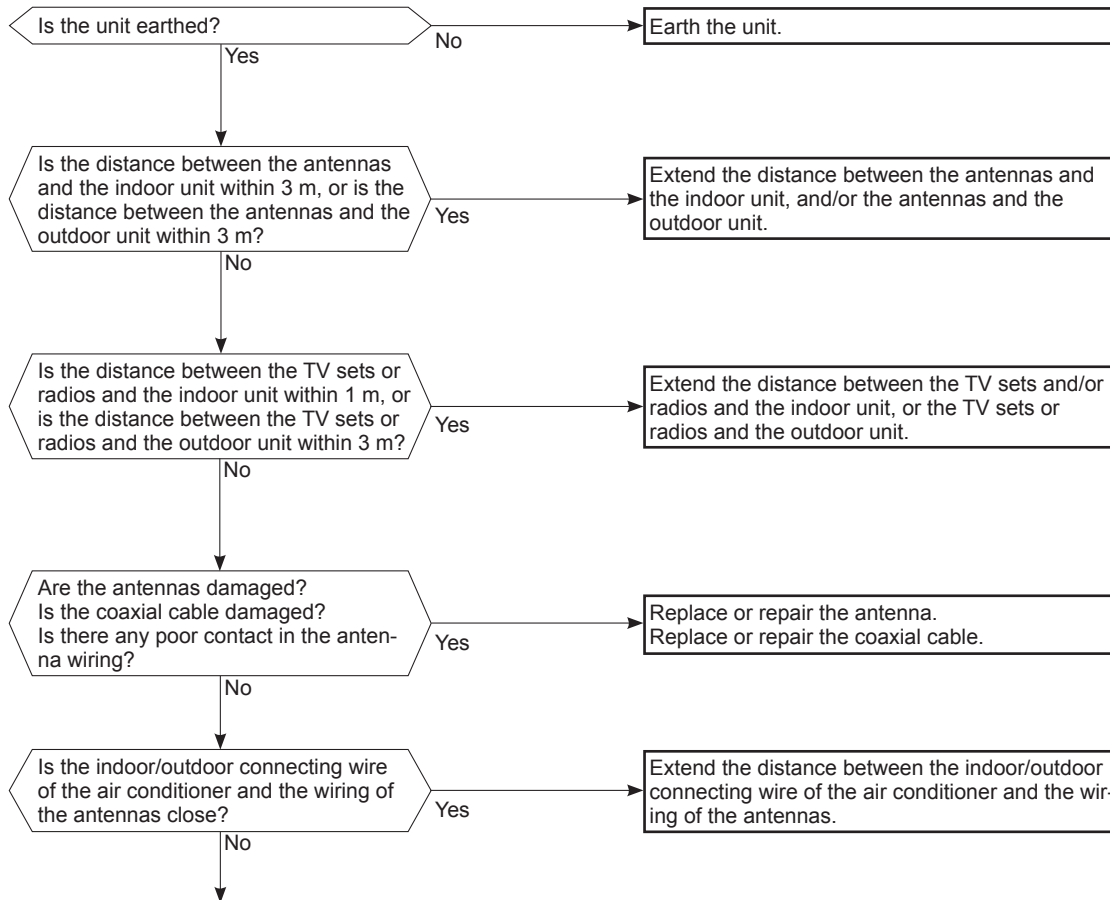

Even if all of the above conditions are fulfilled, the electromagnetic noise may enter, depending on the electric field strength or the installation condition (combination of specific conditions such as antennas or wiring).
Check the following before asking for service.

1. Devices affected by the electromagnetic noise
TV sets, radios (FM/AM broadcast, shortwave)
2. Channel, frequency, broadcast station affected by the electromagnetic noise
3. Channel, frequency, broadcast station unaffected by the electromagnetic noise
4. Layout of;
indoor/outdoor unit of the air conditioner, indoor/outdoor wiring, earth wire, antennas, wiring from antennas, receiver
5. Electric field intensity of the broadcast station affected by the electromagnetic noise
6. Presence or absence of amplifier such as booster
7. Operation condition of air conditioner when the electromagnetic noise enters in
 - 1) Turn OFF the power supply once, and then turn ON the power supply. In this situation, check for the electromagnetic noise.
 - 2) Within 3 minutes after turning ON the power supply, press OPERATE/STOP (ON/OFF) button on the remote controller for power ON, and check for the electromagnetic noise.
 - 3) After a short time (3 minutes later after turning ON), the outdoor unit starts running. During operation, check for the electromagnetic noise.
 - 4) Press OPERATE/STOP (ON/OFF) button on the remote controller for power OFF, when the outdoor unit stops but the indoor/outdoor communication still runs on. In this situation, check for the electromagnetic noise.

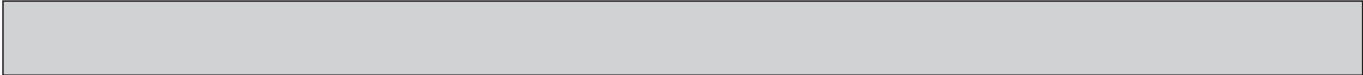

L Check of outdoor refrigerant circuit

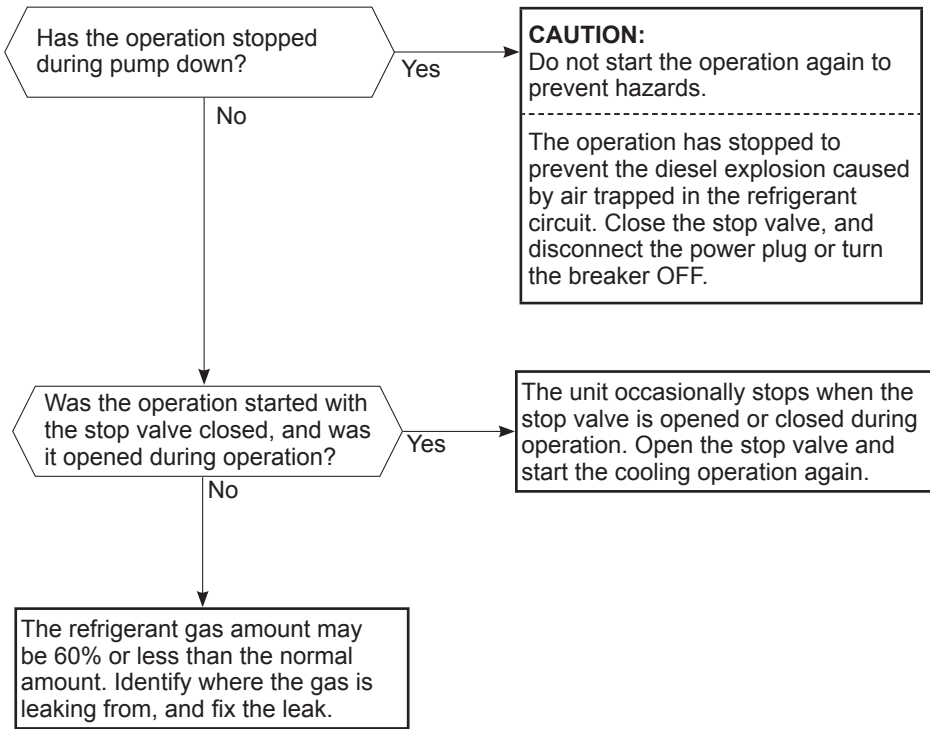

Note: If the abnormality cannot be reset with remote controllers, it is detected in the connected indoor unit. Please refer to the indoor unit's service manual.

11-6. TEST POINT DIAGRAM AND VOLTAGE

11-6-1. Inverter P.C. board

SUZ-M25VA.TH
 SUZ-M25VAR1.TH
 SUZ-M25VAR2.TH
 SUZ-M25VA-ET.TH
 SUZ-M25VA-ETR2.TH

SUZ-M35VA.TH
 SUZ-M35VAR1.TH
 SUZ-M35VAR2.TH
 SUZ-M35VA-ET.TH
 SUZ-M35VA-ETR2.TH

SUZ-M50VA.TH
 SUZ-M50VAR1.TH
 SUZ-M50VAR2.TH
 SUZ-M50VA-ET.TH
 SUZ-M50VA-ETR2.TH

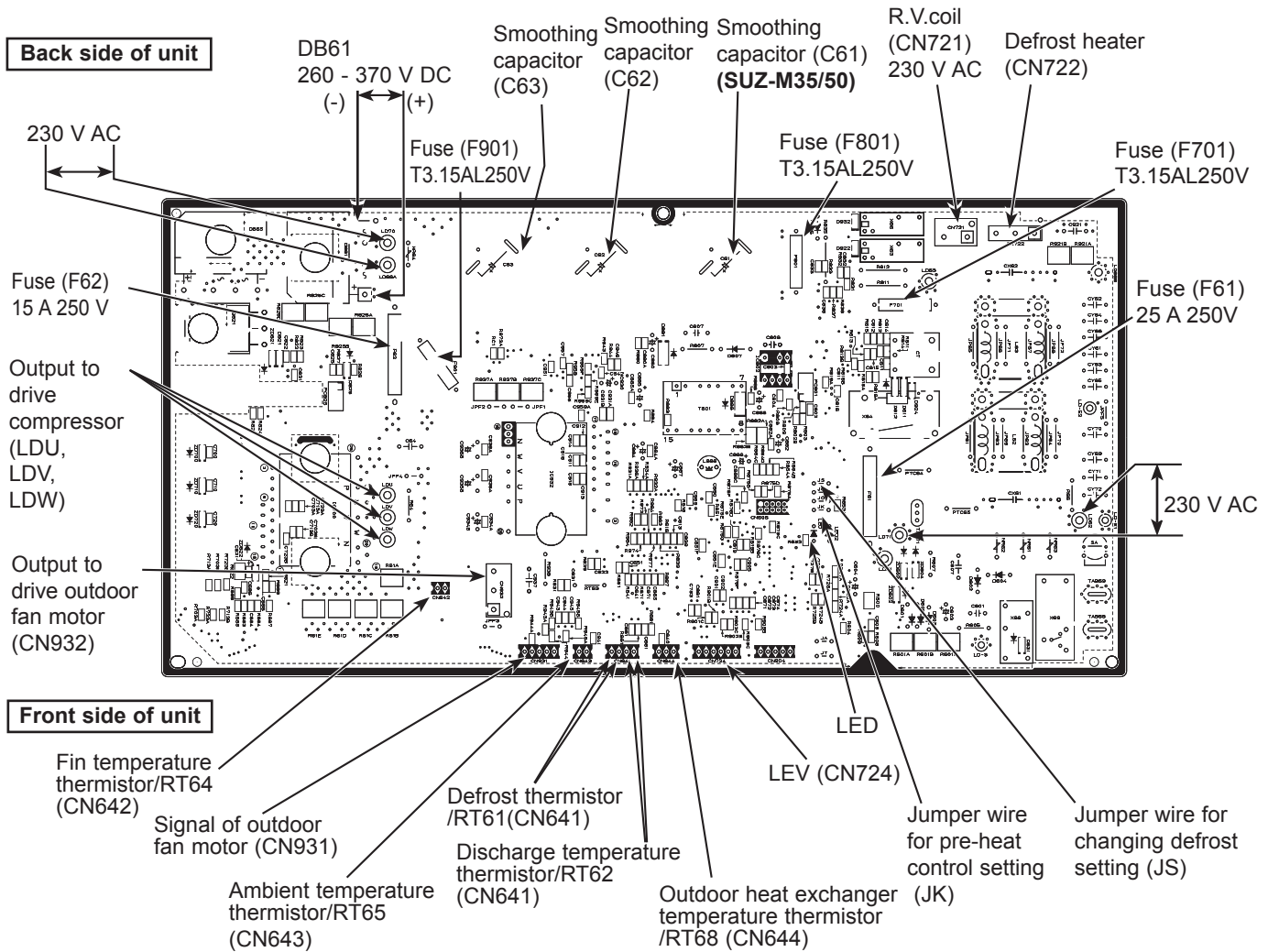

Defrost thermistor(RT61)
 Ambient temperature thermistor(RT65)
 Outdoor heat exchanger temperature thermistor(RT68)

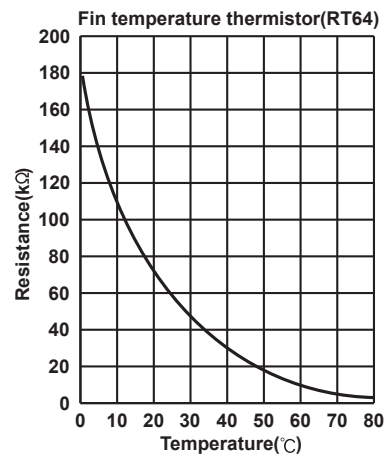
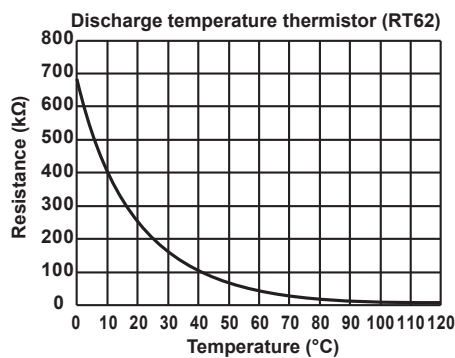
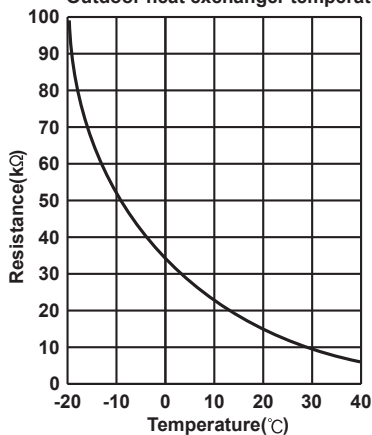

11-6-2. Inverter P.C. board

SUZ-M60VA.TH

SUZ-M60VAR1.TH

SUZ-M60VAR2.TH

SUZ-M60VA-ET.TH

SUZ-M60VA-ETR2.TH

SUZ-M71VA.TH

SUZ-M71VAR1.TH

SUZ-M71VA-ET.TH

SUZ-M71VA-ETR1.TH

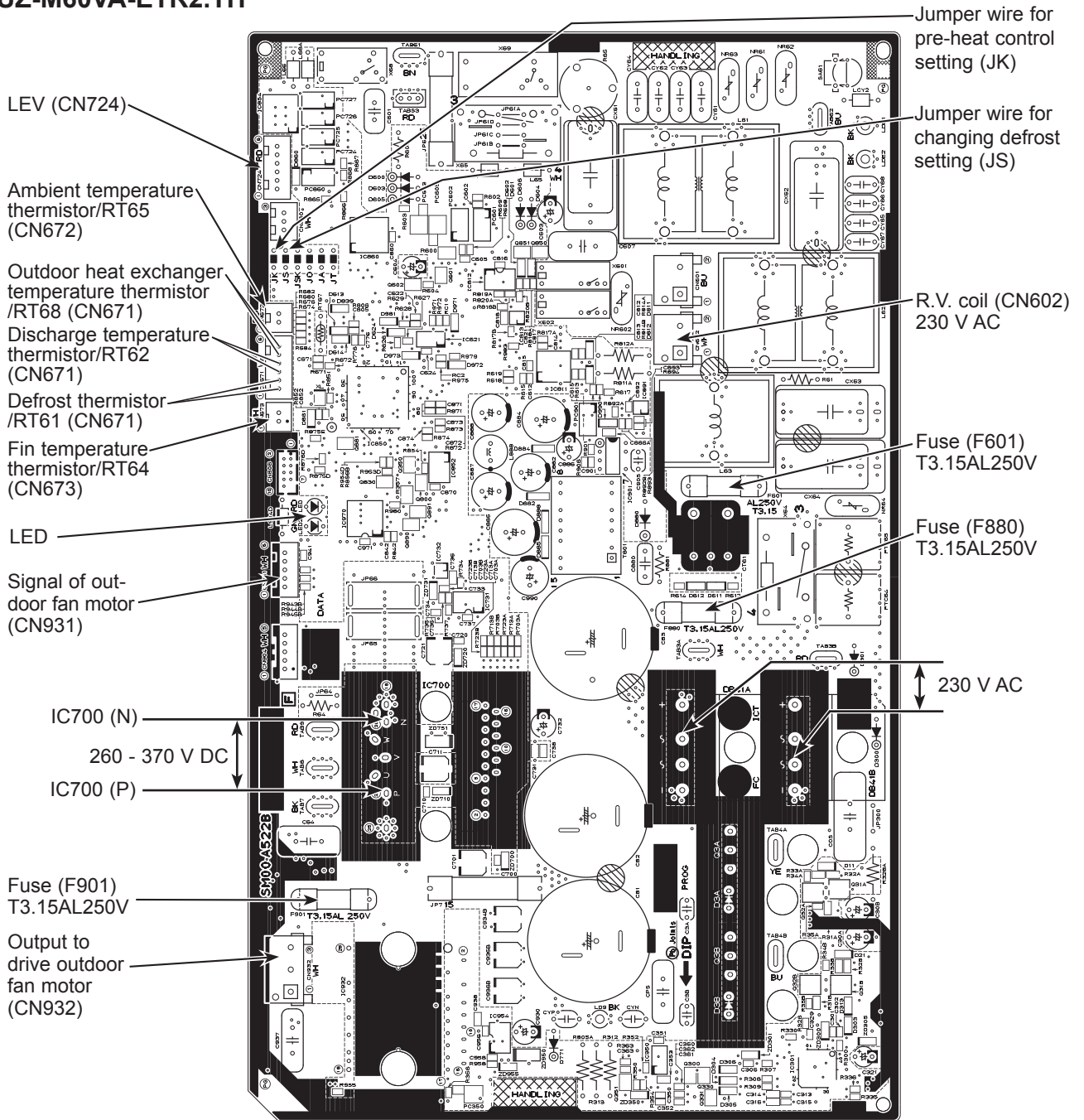

Defrost thermistor (RT61)
Ambient temperature thermistor (RT65)
Outdoor heat exchanger temperature thermistor (RT68)

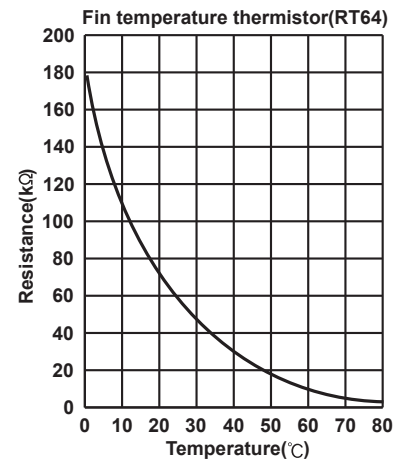
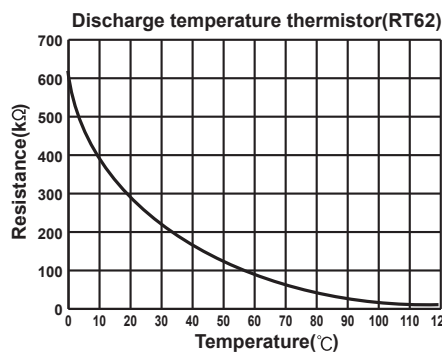
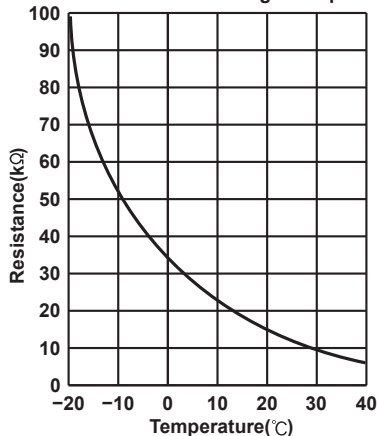

<"Terminal with locking mechanism" Detaching points>

The terminal which has the locking mechanism can be detached as shown below.
 There are 2 types (Refer to (1) and (2)) of the terminal with locking mechanism.
 The terminal without locking mechanism can be detached by pulling it out.
 Check the shape of the terminal before detaching.

(1) Slide the sleeve and check if there is a locking lever or not.

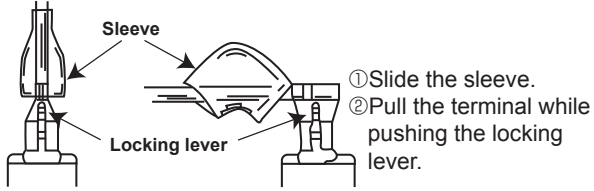

(2) The terminal with this connector has the locking mechanism.

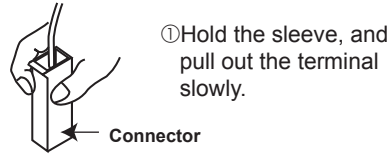

SUZ-M25VA.TH
SUZ-M25VAR1.TH
SUZ-M25VAR2.TH
SUZ-M25VA-ET.TH
SUZ-M25VA-ETR2.TH

SUZ-M35VA.TH
SUZ-M35VAR1.TH
SUZ-M35VAR2.TH
SUZ-M35VA-ET.TH
SUZ-M35VA-ETR2.TH

—————> : Indicates the visible parts in the photos/figures.
 - - - - -> : Indicates the invisible parts in the photos/figures.

NOTE: Turn OFF the power supply before disassembly.

OPERATING PROCEDURE	PHOTOS/FIGURES
<p>1. Removing the cabinet</p> <p>(1) Remove the screw fixing the service panel. (2) Pull down the service panel and remove it. (3) Disconnect the power supply cord and indoor/outdoor connecting wire. (4) Remove the screws fixing the top panel. (5) Remove the top panel. (6) Remove the screws fixing the cabinet. (7) Remove the cabinet. (8) Remove the screws fixing the back panel. (9) Remove the back panel.</p> <p>Photo 3</p>	<p>Photo 1</p> <p>Photo 2</p>

OPERATING PROCEDURE

2. Removing the inverter assembly, inverter P.C. board

- (1) Remove the cabinet and panels. (Refer to section 1.)
- (2) Disconnect the lead wire to the reactor and the following connectors:
 - <Inverter P.C. board>
 - CN721 (R.V. coil)
 - CN931, CN932 (Fan motor)
 - CN641 (Defrost thermistor and discharge temperature thermistor)
 - CN643 (Ambient temperature thermistor)
 - CN644 (Outdoor heat exchanger temperature thermistor)
 - CN724 (LEV)
- (3) Remove the compressor connector (CN61).
- (4) Remove the screws fixing the heat sink support and the separator.
- (5) Remove the fixing screws of the terminal block support and the back panel.
- (6) Remove the inverter assembly.
- (7) Remove the screw of the earth wire and screw of the terminal block support.
- (8) Remove the heat sink support from the P.C. board support.
- (9) Remove the screw of the inverter P.C. board and remove the inverter P.C. board from the P.C. board support.

3. Removing R.V. coil

- (1) Remove the cabinet and panels. (Refer to section 1.)
- (2) Disconnect the following connectors:
 - <Inverter P.C. board>
 - CN721 (R.V. coil)
- (3) Remove the R.V. coil.

4. Removing the discharge temperature thermistor, defrost thermistor, outdoor heat exchanger temperature thermistor and ambient temperature thermistor

- (1) Remove the cabinet and panels. (Refer to section 1.)
- (2) Disconnect the lead wire to the reactor and the following connectors:
 - <Inverter P.C. board>
 - CN641 (Defrost thermistor and discharge temperature thermistor)
 - CN643 (Ambient temperature thermistor)
 - CN644 (Outdoor heat exchanger temperature thermistor)
- (3) Pull out the discharge temperature thermistor from its holder.
- (4) Pull out the defrost thermistor from its holder. (Photo 7)
- (5) Pull out the outdoor heat exchanger temperature thermistor from its holder. (Photo 7)
- (6) Pull out the ambient temperature thermistor from its holder.

PHOTOS/FIGURES

Photo 4

Screws of the heat sink support and the separator Screws of the terminal block support and the back panel

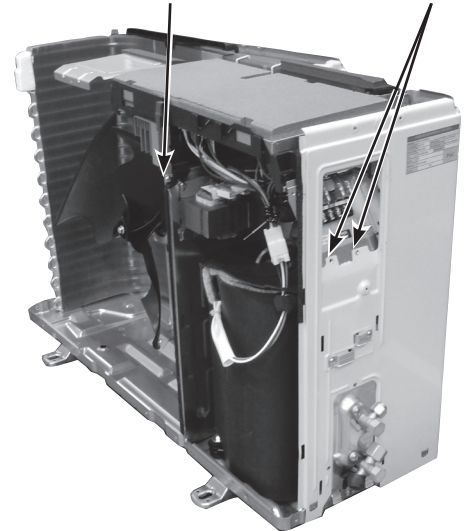

Photo 5 (Inverter assembly)

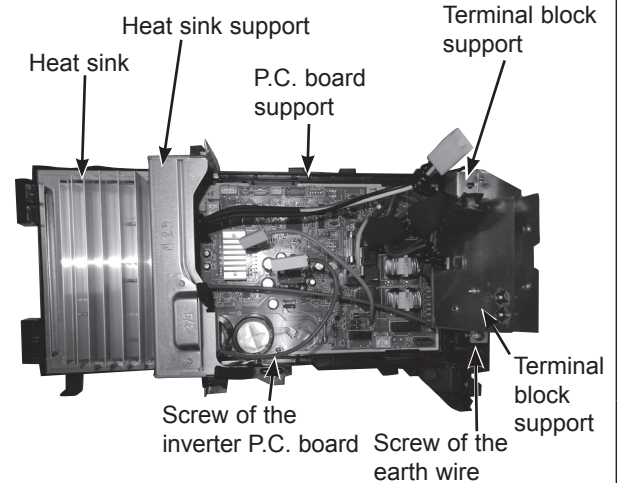
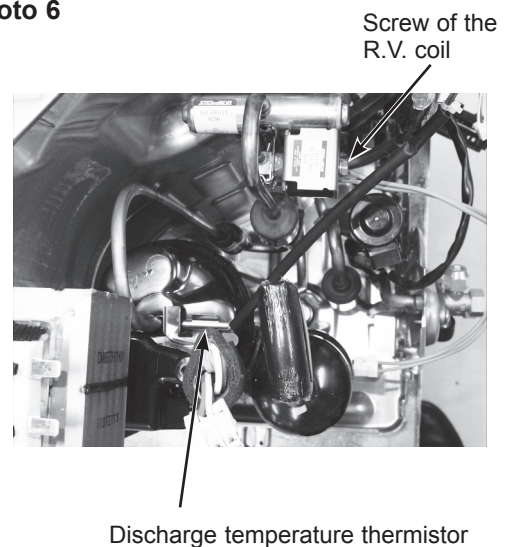

Photo 6



OPERATING PROCEDURE

5. Removing outdoor fan motor

- (1) Remove the cabinet and panels. (Refer to section 1.)
- (2) Disconnect the following connectors:
<Inverter P.C. board>
CN931, CN932 (Fan motor)
- (3) Remove the propeller fan nut.
- (4) Remove the propeller fan.
- (5) Remove the screws fixing the fan motor.
- (6) Remove the fan motor.

6. Removing the compressor and 4-way valve

- (1) Remove the cabinet and panels. (Refer to section 1.)
- (2) Remove the inverter assembly. (Refer to section 2.)
- (3) Recover gas from the refrigerant circuit.
NOTE: Recover gas from the pipes until the pressure gauge shows 0 kg/cm² (0 MPa).
- (4) Detach the brazed part of the suction and the discharge pipe connected with compressor.
- (5) Remove the nuts of compressor legs.
- (6) Remove the compressor.
- (7) Detach the brazed part of pipes connected with 4-way valve.

7. Removing the LEV assembly

- (1) Detaching the brazed part of pipes connected with LEV valve.

Photo 10

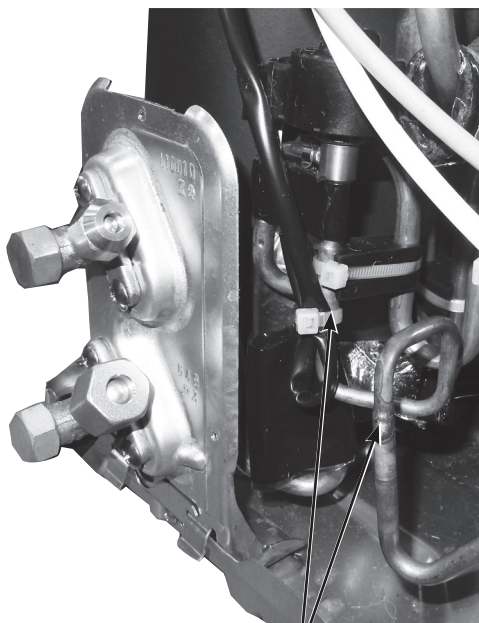

Brazed parts of LEV valve

PHOTOS/FIGURES

Photo 7

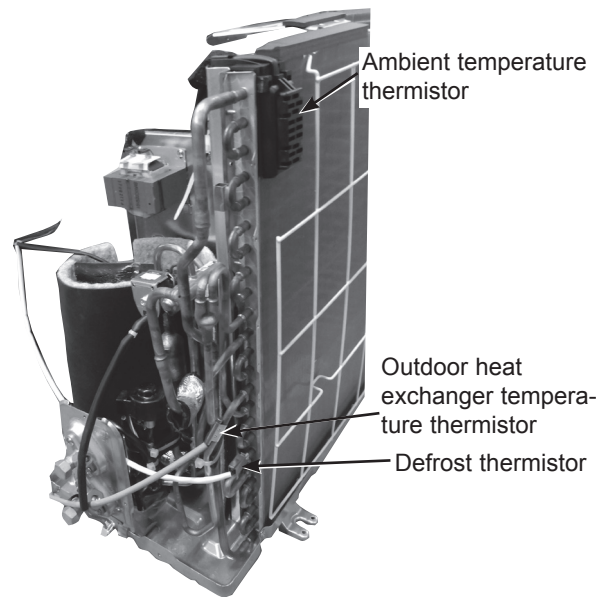

NOTE: SUZ-M25/35VA are different in the installation position of thermistors.

Screws of the outdoor fan motor

Photo 8

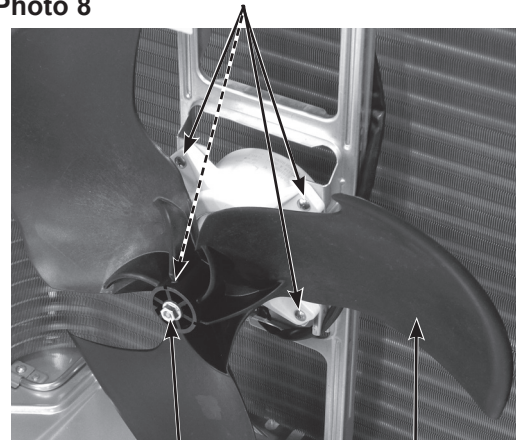

Propeller fan nut

Propeller fan

Photo 9

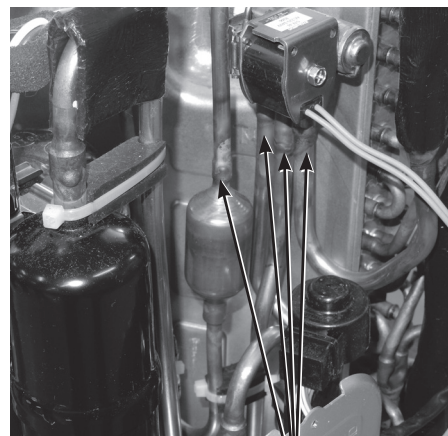

Brazed parts of 4-way valve

SUZ-M50VA.TH
SUZ-M50VAR1.TH
SUZ-M50VAR2.TH
SUZ-M50VA-ET.TH
SUZ-M50VA-ETR2.TH

NOTE: Turn OFF the power supply before disassembly.

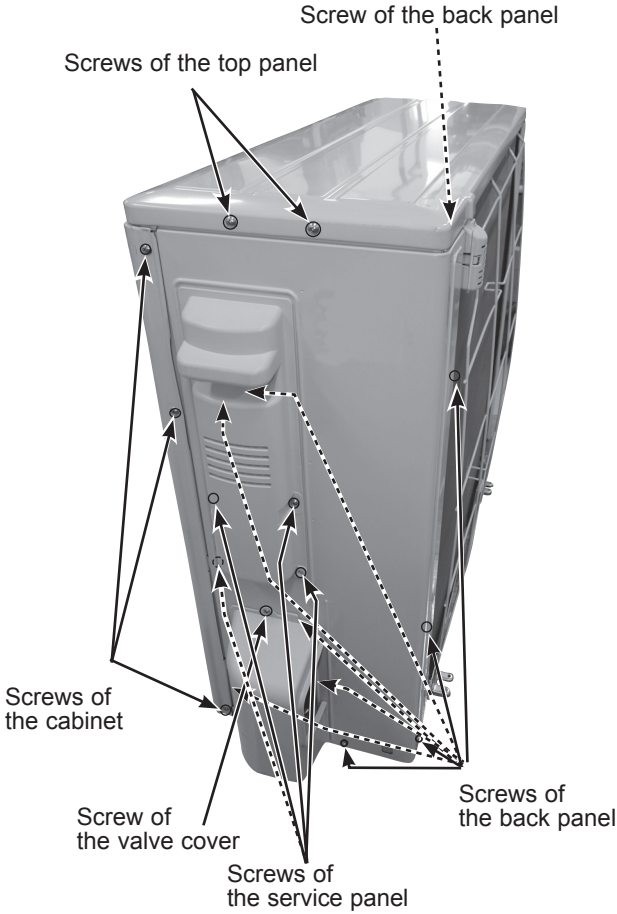
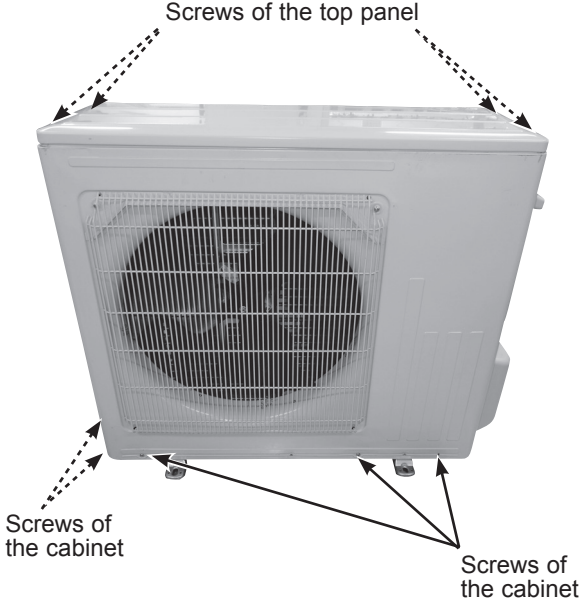
OPERATING PROCEDURE	PHOTOS/FIGURES
<p>1. Removing the cabinet</p> <ol style="list-style-type: none"> (1) Remove the screws of the service panel. (2) Remove the screws of the top panel. (3) Remove the screw of the valve cover. (4) Remove the service panel. (5) Remove the top panel. (6) Remove the valve cover. (7) Disconnect the power supply and indoor/outdoor connecting wire. (8) Remove the screws of the cabinet. (9) Remove the cabinet. (10) Remove the screws of the back panel. (11) Remove the back panel. <p>Photo 2</p> 	<p>Photo 1</p> 

OPERATING PROCEDURE

2. Removing the inverter assembly and inverter P.C. board

- (1) Remove the cabinet and panels. (Refer to section 1.)
- (2) Disconnect the lead wire to the reactor and the following connectors:
 - <Inverter P.C. board>
 - CN721 (R.V. coil)
 - CN931, CN932 (Fan motor)
 - CN641 (Defrost thermistor and discharge temperature thermistor)
 - CN643 (Ambient temperature thermistor)
 - CN644 (Outdoor heat exchanger temperature thermistor)
 - CN724 (LEV)
- (3) Remove the compressor connector (CN61).
- (4) Remove the screws fixing the heat sink support and the separator.
- (5) Remove the fixing screw of the P.B. support and the separator.
- (6) Remove the fixing screws of the terminal block support and the back panel.
- (7) Remove the inverter assembly.
- (8) Remove the heat sink support from the P.C. board support.
- (9) Remove the screw of the inverter P.C. board and remove the inverter P.C. board from the P.C. board support.

* Connection procedure when attaching the inverter P.C. board (Photo 4)

1. Connect the lead wires of the heat exchanger temperature thermistor, the defrost thermistor and discharge temperature thermistor to the connector on the inverter P.C. board. Pull the lead wires toward you and put them on the right hook on the P.C. board support.
2. Connect the lead wires of the LEV to the connector on the inverter P.C. board. Pull the lead wires toward you and put them on the right hook on the P.C. board support.
3. Connect the lead wires of the ambient temperature thermistor to the connector on the inverter P.C. board. Pull the lead wires toward you and put them on the left hook on the P.C. board support so that the fan motor lead wires are bundled up as shown in Photo 4.

PHOTOS/FIGURES

Photo 3

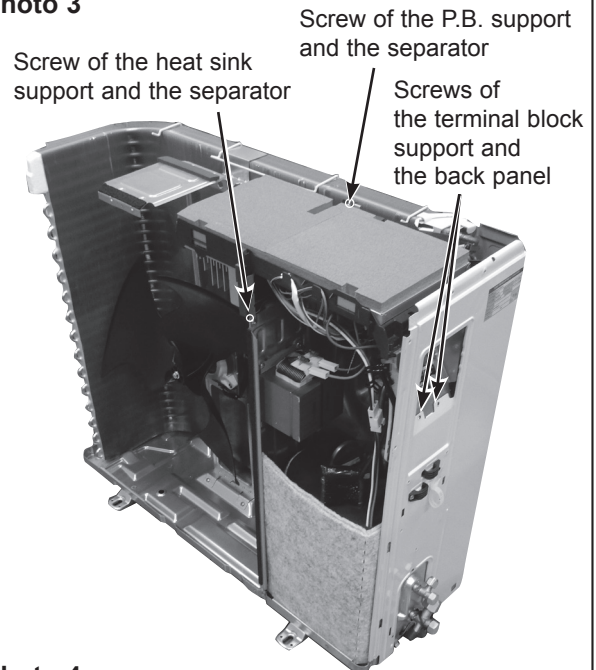
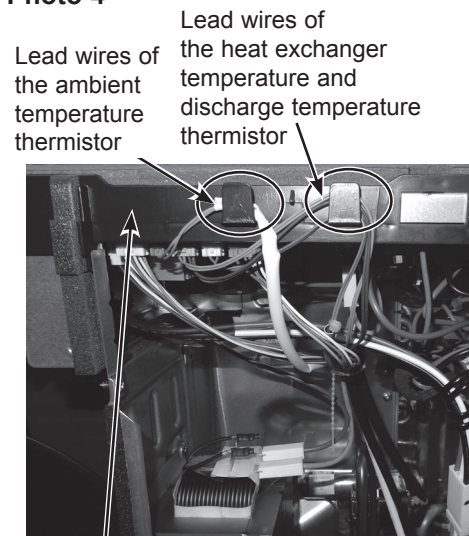
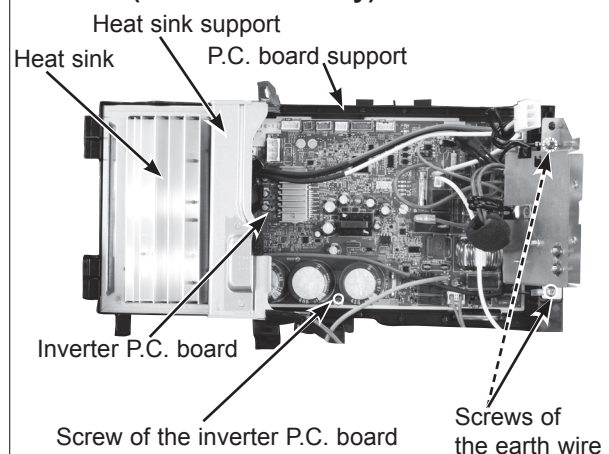

Photo 4



Inverter P.C. board support

Photo 5 (Inverter assembly)



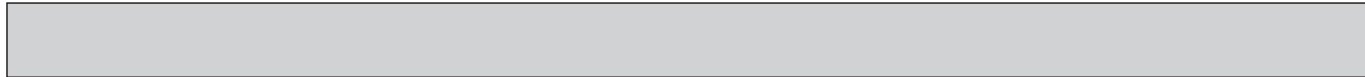

OPERATING PROCEDURE

3. Removing R. V. coil

- (1) Remove the cabinet and panels. (Refer to section 1.)
- (2) Disconnect the following connectors:
<Inverter P.C. board>
CN721 (R.V. coil)
- (3) Remove the R.V. coil.

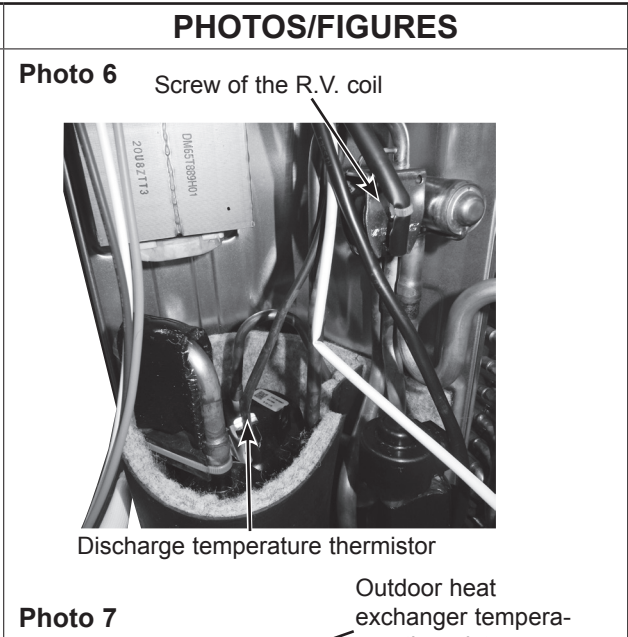

4. Removing the discharge temperature thermistor, defrost thermistor, outdoor heat exchanger temperature thermistor and ambient temperature thermistor

- (1) Remove the cabinet and panels. (Refer to section 1.)
- (2) Disconnect the lead wire to the reactor and the following connectors:
<Inverter P.C. board>
CN641 (Defrost thermistor and discharge temperature thermistor)
CN643 (Ambient temperature thermistor)
CN644 (Outdoor heat exchanger temperature thermistor)
- (3) Pull out the discharge temperature thermistor from its holder.
- (4) Pull out the defrost thermistor from its holder.
- (5) Pull out the outdoor heat exchanger temperature thermistor from its holder.
- (6) Pull out the ambient temperature thermistor from its holder.

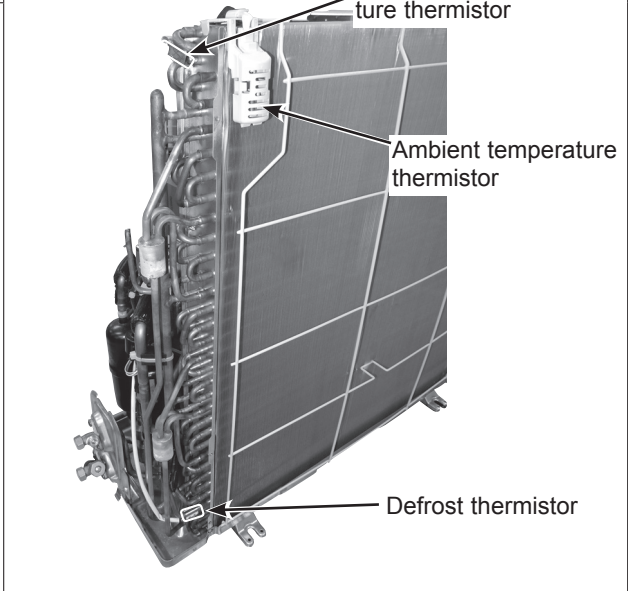

5. Removing outdoor fan motor

- (1) Remove the cabinet and panels. (Refer to section 1.)
- (2) Disconnect the following connectors:
<Inverter P.C. board>
CN931, CN932 (Fan motor)
- (3) Remove the propeller fan nut.
- (4) Remove the propeller fan.
- (5) Remove the screws fixing the fan motor.
- (6) Remove the fan motor.

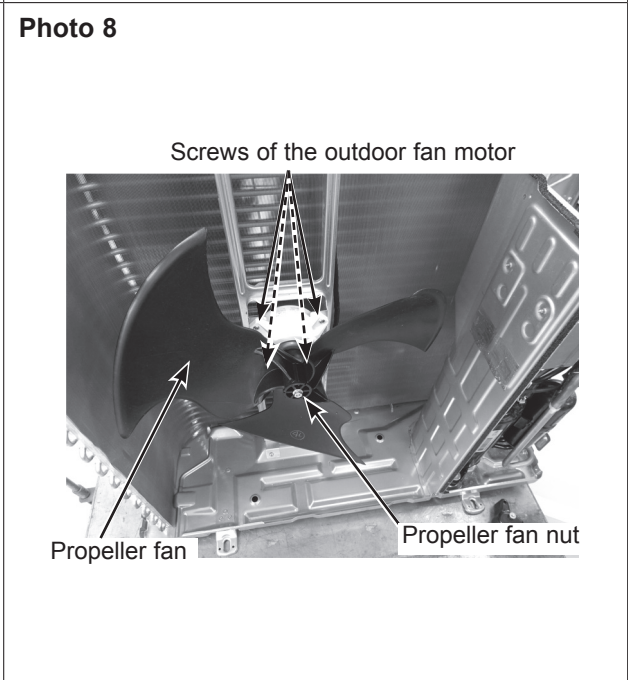

OPERATING PROCEDURE

6. Removing the compressor and 4-way valve

- (1) Remove the cabinet and panels. (Refer to section 1.)
- (2) Remove the inverter assembly. (Refer to section 2.)
- (3) Recover gas from the refrigerant circuit.
NOTE: Recover gas from the pipes until the pressure gauge shows 0 kg/cm² (0 MPa).
- (4) Detach the brazed part of the suction and the discharge pipe connected with compressor.
- (5) Remove the compressor nuts.
- (6) Remove the compressor.
- (7) Detach the brazed part of pipes connected with 4-way valve.

PHOTOS/FIGURES

Photo 9

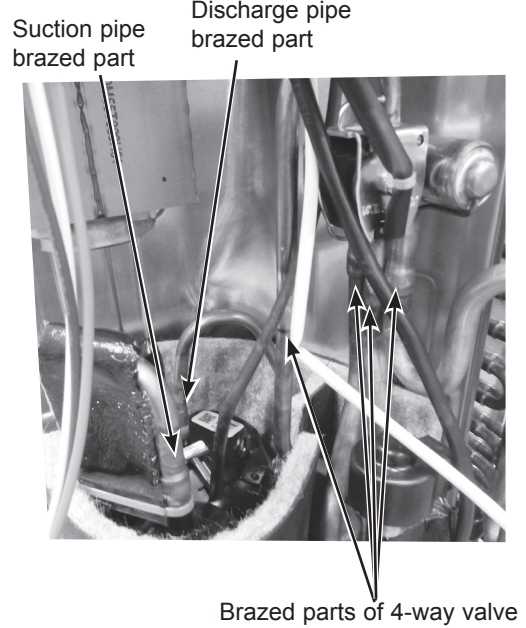

SUZ-M60VA.TH **SUZ-M71VA.TH**
SUZ-M60VAR1.TH **SUZ-M71VAR1.TH**
SUZ-M60VAR2.TH **SUZ-M71VA-ET.TH**
SUZ-M60VA-ET.TH **SUZ-M71VA-ETR1.TH**
SUZ-M60VA-ETR2.TH

NOTE: Turn OFF the power supply before disassembly.

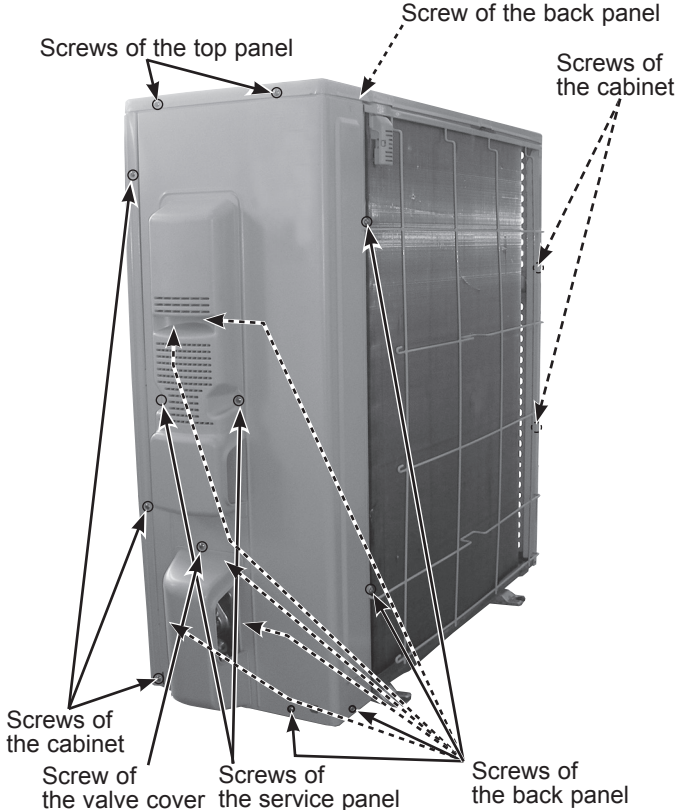
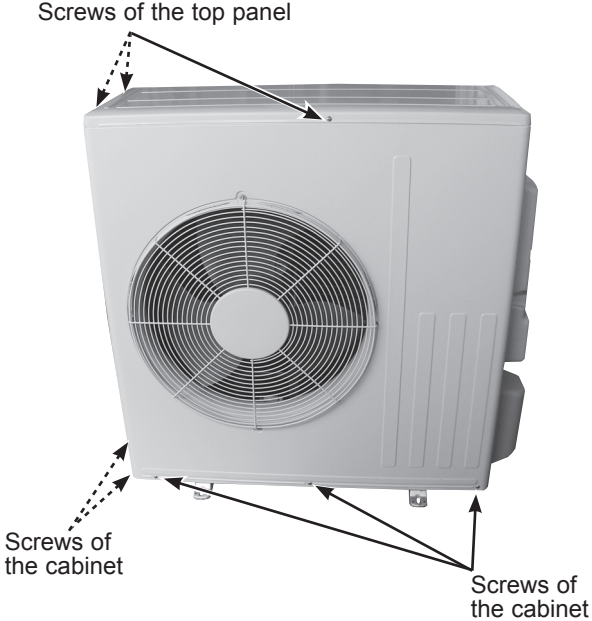
OPERATING PROCEDURE	PHOTOS/FIGURES
<p>1. Removing the cabinet</p> <ol style="list-style-type: none"> (1) Remove the screws of the service panel. (2) Remove the screws of the top panel. (3) Remove the screw of the valve cover. (4) Remove the service panel. (5) Remove the top panel. (6) Remove the valve cover. (7) Disconnect the power supply and indoor/outdoor connecting wire. (8) Remove the screws of the cabinet. (9) Remove the cabinet. (10) Remove the screws of the back panel. (11) Remove the back panel. <p>Photo 2</p> 	<p>Photo 1</p> 

OPERATING PROCEDURE

2. Removing the inverter assembly and inverter P.C. board

- (1) Remove the cabinet and the service panel. (Refer to 1.)
- (2) Disconnect the lead wire to the reactor and the following connectors:
 - <Inverter P.C. board>
 - CN602 (R.V. coil)
 - CN931, CN932 (Fan motor)
 - CN671 (Defrost thermistor, discharge temperature thermistor and outdoor heat exchanger temperature thermistor)
 - CN672 (Ambient temperature thermistor)
 - CN724 (LEV)
- (3) Remove the compressor connector.
- (4) Remove the earth wires and the lead wires of the inverter P.C. board.
- (5) Remove the screws of the P.B. support.
- (6) Remove the P.B. support from the relay panel.
- (7) Remove the screws of the inverter P.C. board.
- (8) Remove the inverter P.C. board from P.B. support.

* Notes about attaching the inverter P.C. board

1. When attaching the inverter P.C. board, clip the lead wires of the reactor to the wire saddles on the bottom of relay panel.
2. After attaching the inverter P.C. board, make sure that the lead wires are connected and placed as shown in Photo 3.

PHOTOS/FIGURES

Photo 3

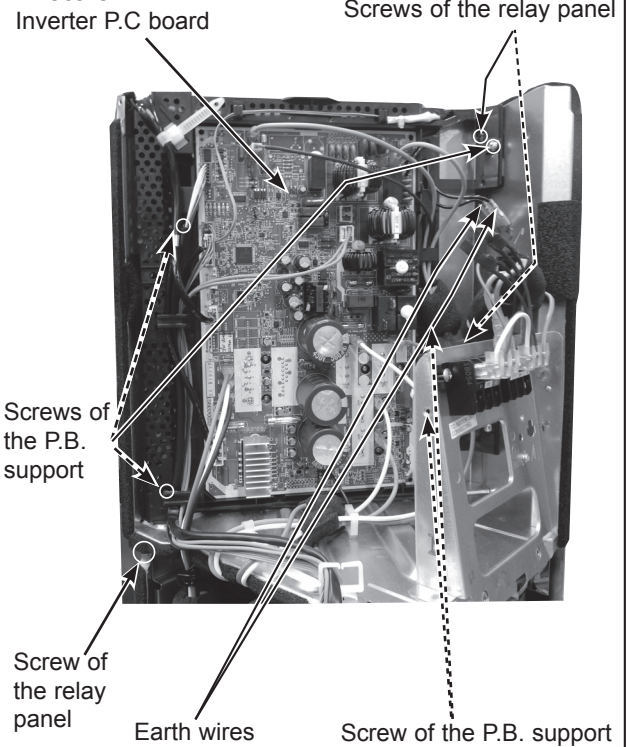
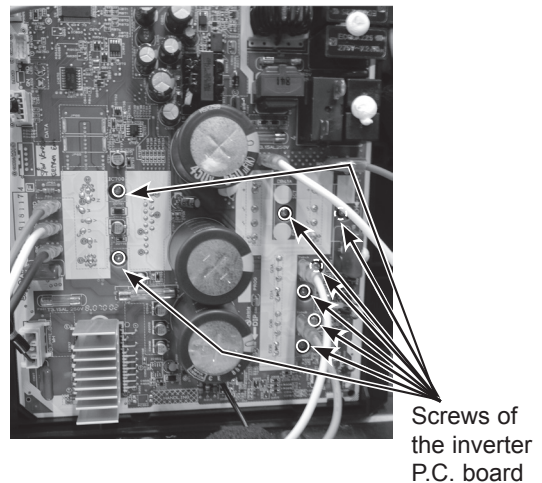

Photo 4



OPERATING PROCEDURE

3. Removing R.V. coil

- (1) Remove the cabinet and panels. (Refer to 1.)
- (2) Disconnect the following connector:
<Inverter P.C. board>
CN602 (R.V. coil)
- (3) Remove the R.V. coil.

4. Removing the discharge temperature thermistor, defrost thermistor, outdoor heat exchanger temperature thermistor and ambient temperature thermistor

- (1) Remove the cabinet and panels. (Refer to 1.)
- (2) Disconnect the lead wire to the reactor and the following connectors:
<Inverter P.C. board>
CN671 (Defrost thermistor, discharge temperature thermistor and outdoor heat exchanger temperature thermistor)
CN672 (Ambient temperature thermistor)
- (3) Pull out the discharge temperature thermistor from its holder. (Photo 8)
- (4) Pull out the defrost thermistor from its holder.
- (5) Pull out the outdoor heat exchanger temperature thermistor from its holder.
- (6) Pull out the ambient temperature thermistor from its holder.

PHOTOS/FIGURES

Photo 5

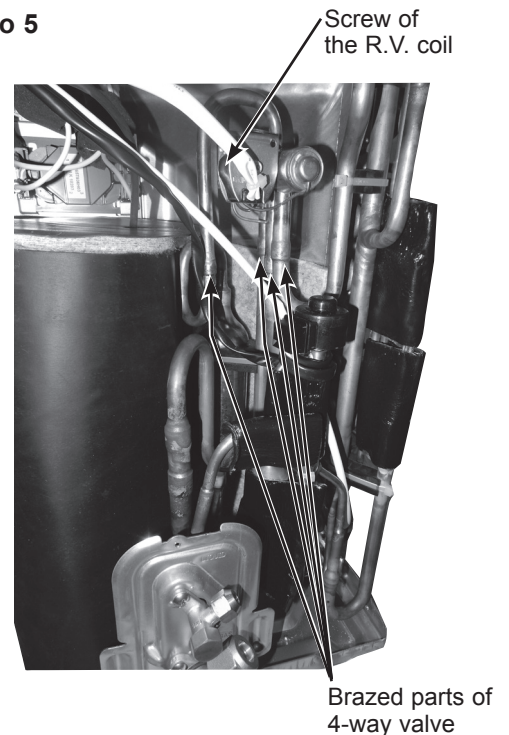
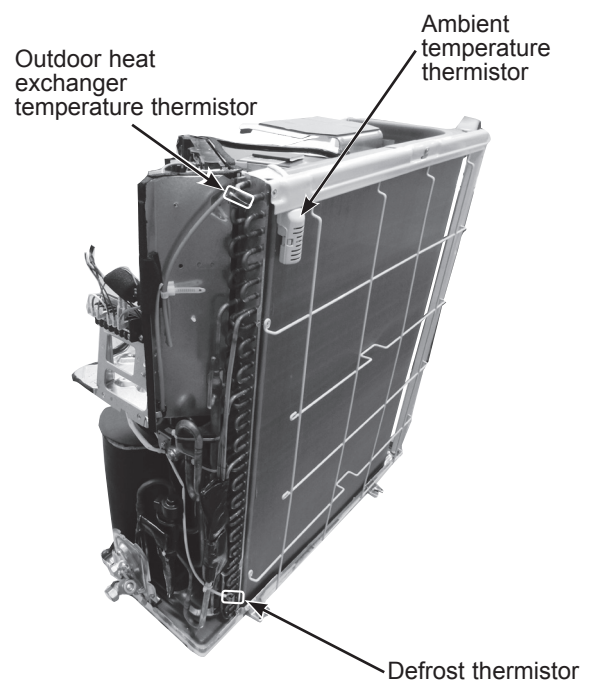

Photo 6



OPERATING PROCEDURE

5. Removing outdoor fan motor

- (1) Remove the top panel, cabinet and service panel. (Refer to 1.)
- (2) Disconnect the following connectors:
<Inverter P.C. board>
CN931, CN932 (Fan motor)
- (3) Remove the propeller fan nut.
- (4) Remove the propeller fan.
- (5) Remove the screws fixing the fan motor.
- (6) Remove the fan motor.

6. Removing the compressor and 4-way valve

- (1) Remove the top panel, cabinet and service panel. (Refer to 1.)
- (2) Remove the back panel. (Refer to 1.)
- (3) Remove the screws fixing the relay panel.
- (4) Remove the relay panel.
- (5) Remove the inverter assembly. (Refer to 2.)
- (6) Recover gas from the refrigerant circuit.
NOTE: Recover gas from the pipes until the pressure gauge shows 0 kg/cm² (0 MPa).
- (7) Detach the brazed part of the suction and the discharge pipe connected with compressor.
- (8) Remove the compressor nuts.
- (9) Remove the compressor.
- (10) Detach the brazed parts of 4-way valve and pipe. (Photo 5)

PHOTOS/FIGURES

Photo 7

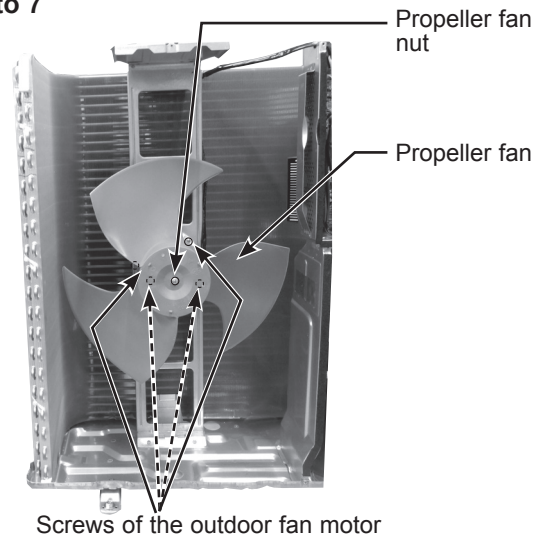
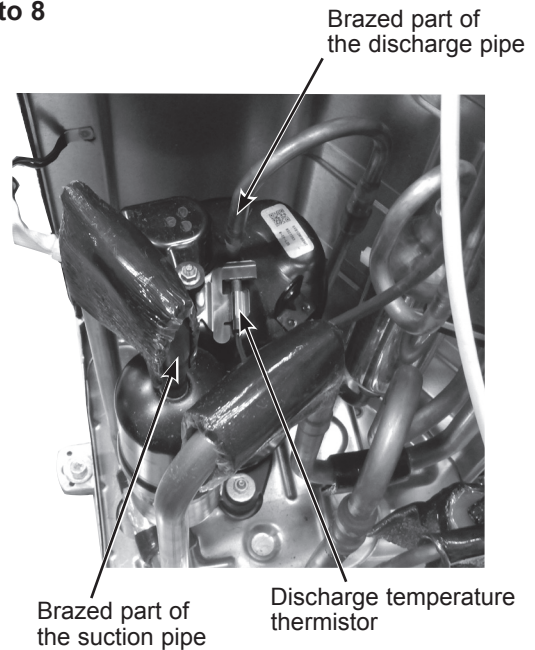

Photo 8





Mr. SLIM

mitsubishi electric corporation

HEAD OFFICE: TOKYO BUILDING, 2-7-3, MARUNOUCHI, CHIYODA-KU, TOKYO100-8310, JAPAN

©Copyright 2018 MITSUBISHI ELECTRIC CORPORATION
Issued: Jan. 2020 No. OCH684 REVISED EDITION-C
Issued: Jun. 2019 No. OCH684 REVISED EDITION-B
Issued: Jan. 2019 No. OCH684 REVISED EDITION-A
Published: Dec. 2018 No. OCH684
Made in Japan

Specifications are subject to change without notice.