



AZURI[®]

SERVICE MANUAL



DELTRON[®]

Table of Contents

Part I : Technical Information	1
1. Summary	1
2. Specification	2
3. Outline Dimension Diagram	1
4. Refrigerant System Diagram	1
5. Electrical Part	6
5.1 Wiring Diagram.....	6
5.2 PCB Printed Diagram	9
6. Function and Control	10
Part II : Installation and Maintenance	12
7. Notes for Installation and Maintenance	12
8. Installation Manual	16
8.1 Preparation before Installation.....	17
8.2 Installation Instruction.....	19
9. Troubleshooting	25
9.1 Malfunction Indicator	25
9.2 Malfunction Checking and Elimination.....	26
9.3 Maintenance Method for Normal Malfunction.....	38
10. Removal Procedure	40

2. Specification

Model			AZI-OR100VB/O	AZI-OR120VB/O
Product Code			CN860W0311	CN860W0321
Power supply	Rated Voltage	V~	220-240	220-240
	Rated Frequency	Hz	50	50
	Phases		1	1
Cooling capacity(max~min)		W	10500(2600~12000)	12000(2600~12000)
Heating capacity(max~min)		W	12000(2600~13500)	12000(2600~14500)
Cooling Power Input		W	3100	3450
Heating Power Input		W	3200	3500
Cooling Current Input		A	14	16
Heating Current Input		A	13	15
Rated Power Input		W	4000	4000
Rated Current		A	20	20
AEER		W/W	/	/
ACOP		W/W	/	/
Outdoor Unit	Compressor Trademark		ZHUHAI LANDA COMPRESSOR CO.,LTD	ZHUHAI LANDA COMPRESSOR CO.,LTD
	Compressor Model		QXFS-D32zX090D	QXFS-D32zX090D
	Compressor Refrigerant Oil Type		FW68DA	FW68DA
	Compressor Type		Inverter Rotary	Inverter Rotary
	L.R.A		A	/
	Compressor Rated Load Amp (RLA)		A	17.8
	Compressor Power Input		W	3750
	Compressor Thermal Protector			1NT11L-6233/HPC115/95U1/ KSD115 C
	Throttling Method			Electron expansion valve
	Cooling Operation Ambient Temperature Range		°C	-15~43
	Heating Operation Ambient Temperature Range		°C	-20~24
	Condenser Material			Aluminum Fin-copper Tube
	Condenser Pipe Diameter		mm	Φ7.94
	Rows-Fin Gap(mm)		mm	2-1.4
	Coil length (l) X height (H) X coil width (L)		mm	1056X286X776
	Fan Motor Speed (rpm) (H/M/L)		rpm	820
	Output of Fan Motor		W	170
	Fan Motor RLA		A	/
	Fan Motor Capacitor		μF	/
	Air Flow Volume of Outdoor Unit		m ³ /h	5500
	Fan Type-Piece			Axial-flow
	Fan Diameter		mm	Φ570
	Defrosting Method			Automatic Defrosting
	Climate Type			T1
	Isolation			I
	Moisture Protection			IPX4
	Permissible Excessive Operating Pressure for the Discharge Side		MPa	4.3
	Permissible Excessive Operating Pressure for the Suction Side		MPa	2.5
	Dimension (WXHXD)		mm	1087X1103X440
	Dimension of Package (LXWXH)		mm	1155X480X1115
Dimension of Package(LXWXH)		mm	1158X483X1130	
Net Weight		kg	90	
Gross Weight		kg	98	
Refrigerant Charge			R32	
Refrigerant Charge		kg	2.75	

3. Outline Dimension Diagram

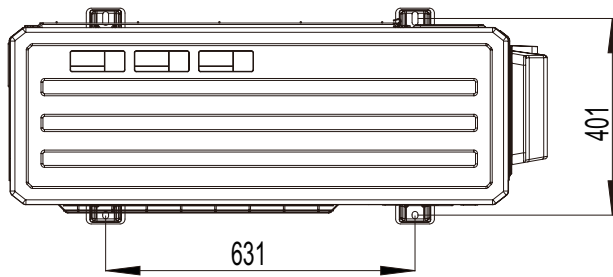
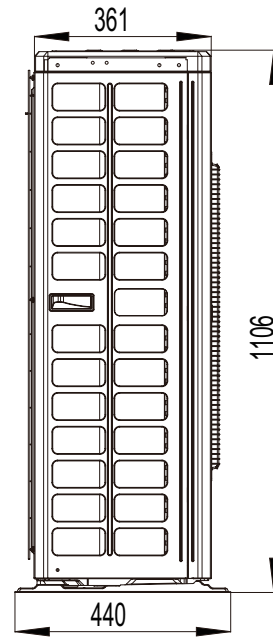
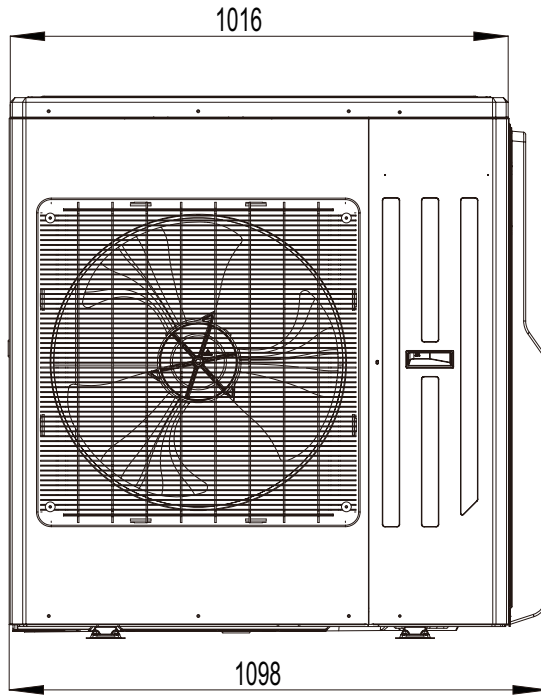

Unit:mm

5. Electrical Part

5.1 Wiring Diagram

• Instruction

Symbol	Symbol Color	Symbol	Symbol Color	Symbol	Name
WH	White	GN	GREEN	COMP	Compressor
YE	Yellow	BN	Brown		Grounding wire
RD	Red	BU	Blue		
YEGN	Yellow/Green	BK	Black		
VT	Violet	OG	Orange		

• Outdoor Unit

(2)Model:AZI-OR120VB/O

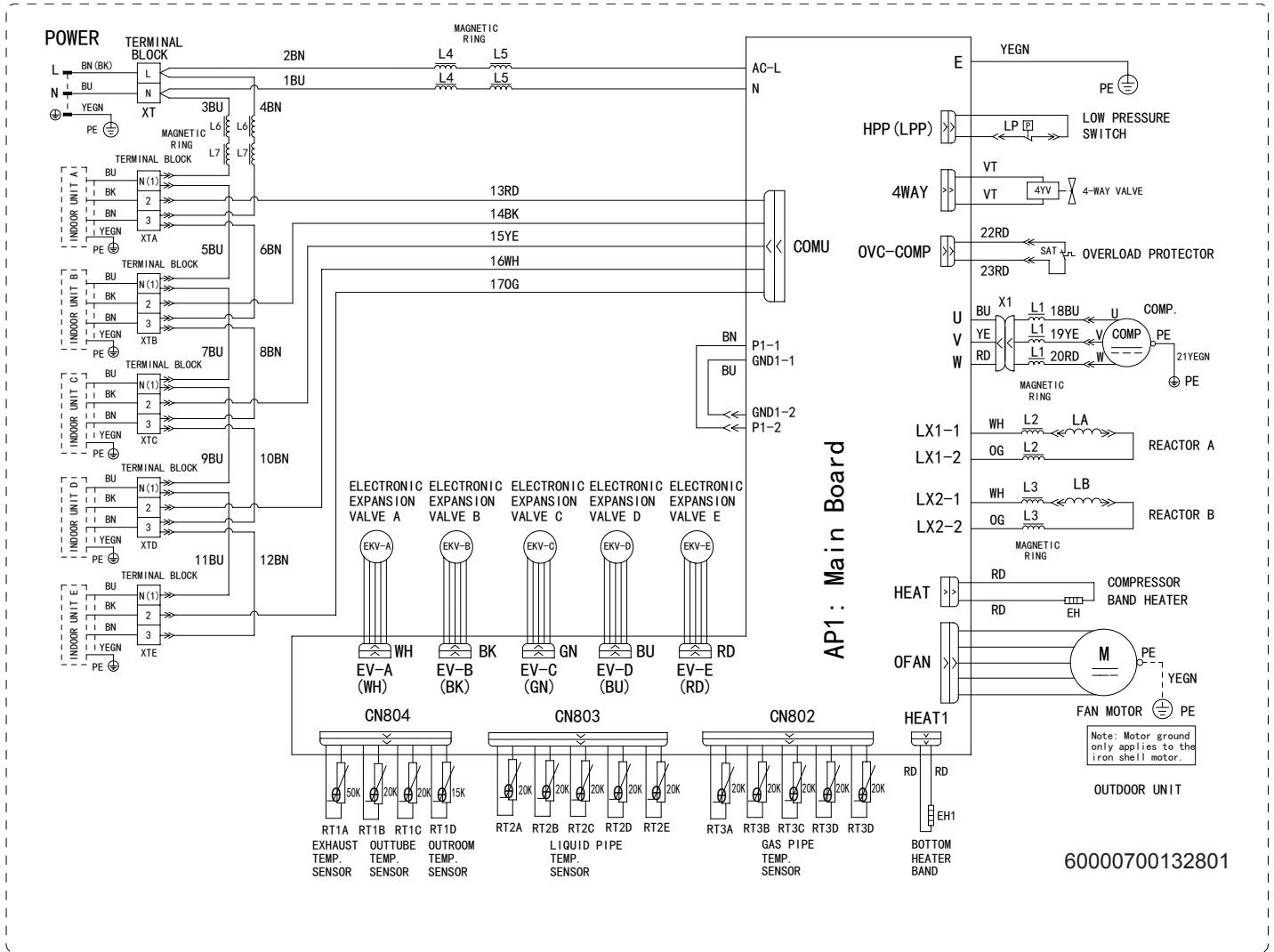

These circuit diagrams are subject to change without notice, please refer to the one supplied with the unit.

6. Function and Control

1. Function Control

1) Cooling mode

a. Turning on the unit for cooling operation, and if any one of the indoor units satisfy the cooling operation condition, the system will start for cooling operation; and the electronic expansion valve, the outdoor fan and the compressor start operation.

b. When some of the indoor units satisfy the stop-condition while some indoor units does not satisfy the stop-condition, the compressor does not stop, the compressor adjust the frequency according to demand. For the indoor unit with stop-condition satisfies, the corresponding electronic expansion valve will be closed.

c. Change Cooling mode to heating mode

When change the unit to heating mode from cooling mode, the whole system will stop first. Then the system will restart in heating mode after the compressor stops.

d. 4-way valve

In this mode, the 4-way valve is closed.

e. Outdoor fan control in cooling mode

The outdoor fan starts before 5s of the starting of compressor. The outdoor fan will run in high speed after starting and then it will run in set speed.

2) Dry mode (dehumidification mode)

This mode is the same as cooling mode;

3) Heating mode

a. Turning on the unit for heating operation, If any one of the indoor unit satisfy the heating condition, the system will start to run in heating mode

b. If all the indoor units satisfy the stop-condition, the compressor stops and the outdoor fan stops after 1min;

c. If only part of the indoor units satisfy the stop-condition, the compressor decrease the frequency immediately and operates according to demand.

d. Change Heating mode to cooling mode or dehumidification mode, the whole system will stop first, then restart under the required mode.

e. Defrosting function

When the defrosting condition is satisfied, the 4-way valve reverses the direction, the outdoor fan stop. After the 4-way valve reverses the direction, the frequency of compressor rises, and the unit will start defrosting under cooling cycle.

4) Fan mode

Only indoor fan run. Compressor, outdoor fan and 4-way valve are closed .

2. Protection Function

1) Mode conflict protection of indoor unit

When the setting mode is different of different indoor unit, the unit runs in below status:

a. The system mode is determined by the first turning on indoor unit except indoor unit is in fan mode. Cooling mode (dry mode) is in conflict with heating mode.

b. If the first turning on unit is fan mode, and the second turning on unit is cooling or heating mode, then the system will run in cooling or heating mode

2) Overload protection

If the tube temperature at the high pressure side is higher than normal, the compressor frequency is restricted or decreased to normal operation frequency.

3) High exhaust temperature protection

If the exhaust temperature is higher than protection value, the compressor stops running.

If the exhaust temperature protection continuously appears for 6 times, the compressor can't resume running. In this case, only by cutting off the power and then reenergize that the compressor can restart. If the running duration of the compressor is longer than 10min, the protection times will be cleared to zero time.

4) Communication malfunction

Detection of the quantity of installed indoor units: after 3min of energizing, if the outdoor unit does not receive the communication data of certain indoor unit, the outdoor unit will judge that indoor unit is not installed. If the outdoor unit receives the communication data of that indoor unit later, the communication malfunction will be cleared.

5) System high-pressure protection

- a. When the high-pressure switch detects the system pressure higher than limit, then the high-pressure switch cuts off, the system will stop to run.
- b. If high-pressure protection is detected for two times within one hour, only by cutting off the power and then reenergize that the compressor can restart.

6) Compressor overload protection

No matter the compressor is on or off, when the compressor overload switch is detected activated, the system will stop and indoor unit will display H3. If the compressor overload protection appears for more than 6 times, in this case, only by cutting off the power and then reenergize that the compressor can restart. If the running duration of the compressor is longer than 30min, the protection times will be cleared to zero.

7) Antifreeze protection

Under cooling and dry mode, 6minutes after the compressor is started:

When it is detected for 3 minutes successively that T_{evap} is less than -2°C (varying with indoor unit), the antifreeze protection will be activated, in which case the outdoor unit will immediately shut off the indoor electronic expansion valve and the capacity will be set to "0". If T_{evap} exceed 13°C and the compressor has remained at OFF for at least 3minutes, the compressor will resume its original operation state.

8) IPM Protection

a. When the IPM module protection is detected, the unit will stop as the indoor temperature reaching set temperature, PFC is closed, display IPM protection malfunction. After the compressor stops for 3min, the unit will resume operation status automatically; if the IPM protection is detected for more than 6 times continuously (If the running time of the compressor is longer than 10min, the protection times record will be cleared), the system will stop and send the signal of module protection to indoor unit. The unit can not resume operation status automatically, but can resume running only after cutting off the power and then putting through the power.

b. IPM module overheating protection

(a) When $T_{IPM} > 88^{\circ}\text{C}$, prohibit to raise frequency;

(b) When $88^{\circ}\text{C} < T_{IPM} < 95^{\circ}\text{C}$, the operation frequency of compressor lows down 1HZ/1s;

(c) When $T_{IPM} > 100^{\circ}\text{C}$, the compressor stops. After the compressor stops for 3min, if $T_{IPM} < 77^{\circ}\text{C}$, the compressor and the outdoor fan will resume operation.

9) DRED function

If the power of DRED device is supplied by switching power supply, when different DRED signals are received, the corresponding optocouplers are put through to make the AD sample circuit on the main board detect the different voltages. Different voltages are corresponding to different DRED modes. After entering DRED mode, the indoor unit displays the corresponding operation code of DRED mode.

d1: Outdoor compressor stops;

d2: The electricity consumption of complete unit in 30min is less than or equals to 50% of rated electricity consumption;

d3: The electricity consumption of complete unit in 30min is less than or equals to 75% of rated electricity consumption

Part II : Installation and Maintenance

7. Notes for Installation and Maintenance

Safety Precautions: Important!

Please read the safety precautions carefully before installation and maintenance.

The following contents are very important for installation and maintenance.

Please follow the instructions below.

- The installation or maintenance must accord with the instructions.
- Comply with all national electrical codes and local electrical codes.
- Pay attention to the warnings and cautions in this manual.
- All installation and maintenance shall be performed by distributor or qualified person
- All electric work must be performed by a licensed technician according to local regulations and the instructions given in this manual.
- Be caution during installation and maintenance. Prohibit incorrect operation to prevent electric shock, casualty and other accidents.



Warnings

Electrical Safety Precautions:

1. Cut off the power supply of air conditioner before checking and maintenance.
2. The air condition must apply specialized circuit and prohibit share the same circuit with other appliances.
3. The air conditioner should be installed in suitable location and ensure the power plug is touchable.
4. Make sure each wiring terminal is connected firmly during installation and maintenance.
5. Have the unit adequately grounded. The grounding wire can't be used for other purposes.
6. Must apply protective accessories such as protective boards, cable-cross loop and wire clip.
7. The live wire, neutral wire and grounding wire of power supply must be corresponding to the live wire, neutral wire and grounding wire of the air conditioner.
8. The power cord and power connection wires can't be pressed by hard objects.
9. If power cord or connection wire is broken, it must be replaced by a qualified person

10. If the power cord or connection wire is not long enough, please get the specialized power cord or connection wire from the manufacture or distributor. Prohibit prolong the wire by yourself.

11. For the air conditioner without plug, an air switch must be installed in the circuit. The air switch should be all-pole parting and the contact parting distance should be more than 3m.

12. Make sure all wires and pipes are connected properly and the valves are opened before energizing.

13. Check if there is electric leakage on the unit body. If yes, please eliminate the electric leakage.

14. Replace the fuse with a new one of the same specification if it is burnt down; don't replace it with a cooper wire or conducting wire.

15. If the unit is to be installed in a humid place, the circuit breaker must be installed.

Installation Safety Precautions:

1. Select the installation location according to the requirement of this manual.(See the requirements in installation part)
2. Handle unit transportation with care; the unit should not be carried by only one person if it is more than 20kg.
3. When installing the indoor unit and outdoor unit, a sufficient fixing bolt must be installed; make sure the installation support is firm
4. Ware safety belt if the height of working is above 2m.
5. Use equipped components or appointed components during installation.
6. Make sure no foreign objects are left in the unit after finishing installation.

Refrigerant Safety Precautions:

1. Avoid contact between refrigerant and fire as it generates poisonous gas; Prohibit prolong the connection pipe by welding.
2. Apply specified refrigerant only. Never have it mixed with any other refrigerant. Never have air remain in the refrigerant line as it may lead to rupture or other hazards.
3. Make sure no refrigerant gas is leaking out when installation is completed.
4. If there is refrigerant leakage, please take sufficient measure to minimize the density of refrigerant.
5. Never touch the refrigerant piping or compressor without wearing glove to avoid scald or frostbite.

Improper installation may lead to fire hazard, explosion electric shock or injury.

Safety Operation of Flammable Refrigerant

Qualification requirement for installation and maintenance ma

- All the work men who are engaging in the refrigeration system should bear the valid certification awarded by the authoritative organization and the qualification for dealing with the refrigeration system recognized by this industry. If it needs other technician to maintain and repair the appliance, they should be supervised by the person who bears the qualification for using the flammable refrigerant
- It can only be repaired by the method suggested by the equipment's manufacturer.

Installation notes

- The air conditioner is not allowed to use in a room that has running fire (such as fire source, working coal gas ware operating heater).
- It is not allowed to drill hole or burn the connection pipe.
- The air conditioner must be installed in a room that is larger than the minimum room area.
The minimum room area is shown on the nameplate or following table a.
- Leak test is a must after installation.

table a - Minimum room area(m²)

Minimum room area(m ²)	Charge amount (kg)	≤1.2	1.3	1.4	1.5	1.6	1.7	1.8	1.9	2	2.1	2.2	2.3	2.4	2.5
	floor location	/	14.5	16.8	19.3	22	24.8	27.8	31	34.3	37.8	41.5	45.4	49.4	53.6
wall mounted	/	5.2	6.1	7	7.9	8.9	10	11.2	12.4	13.6	15	16.3	17.8	19.3	
window mounted	/	1.6	1.9	2.1	2.4	2.8	3.1	3.4	3.8	4.2	4.6	5	5.5	6	
ceiling mounted	/	1.1	1.3	1.4	1.6	1.8	2.1	2.3	2.6	2.8	3.1	3.4	3.7	4	

Maintenance notes

- Check whether the maintenance area or the room area meet the requirement of the nameplate.
— It's only allowed to be operated in the rooms that meet the requirement of the nameplate.
- Check whether the maintenance area is well-ventilated.
— The continuous ventilation status should be kept during the operation process.
- Check whether there is fire source or potential fire source in the maintenance are
— The naked flame is prohibited in the maintenance area; and the "no smoking" warning board should be hanged
- Check whether the appliance mark is in good condition.
— Replace the vague or damaged warning mark.

Welding

- If you should cut or weld the refrigerant system pipes in the process of maintaining, please follow the steps as below:
 - a. Shut down the unit and cut power supply
 - b. Eliminate the refrigerant
 - c. Vacuuming
 - d. Clean it with N2 gas
 - e. Cutting or welding
 - f. Carry back to the service spot for welding
- Make sure that there isn't any naked flame near the outlet of the vacuum pump and it's well-ventilated.
- The refrigerant should be recycled into the specialized storage tank.

Filling the refrigerant

- Use the refrigerant filling appliances specialized for R32. Make sure that different kinds of refrigerant won't contaminate with each other.
- The refrigerant tank should be kept upright at the time of filling refrigerant
- Stick the label on the system after filling is finished (or haven't finished)
- Don't overfilling
- After filling is finished, please do the leakage detection before test running; another time of leak detection should be done when it's removed.

Safety instructions for transportation and storage

- Please use the flammable gas detector to check before unload and open the container.
- No fire source and smoking
- According to the local rules and laws.

Safety Precautions for Installing and Relocating the Unit:

To ensure safety, please be mindful of the following precautions.



Warnings

- 1. When installing or relocating the unit, be sure to keep the refrigerant circuit free from air or substances other than the specified refrigerant**
Any presence of air or other foreign substance in the refrigerant circuit will cause system pressure rise or compressor rupture, resulting in injury.
- 2. When installing or moving this unit, do not charge the refrigerant which is not comply with that on the nameplate or unqualified refrigerant**
Otherwise, it may cause abnormal operation, wrong action, mechanical malfunction or even series safety accident.
- 3. When refrigerant needs to be recovered during relocating or repairing the unit, be sure that the unit is running in cooling mode. Then, fully close the valve at high pressure side (liquid valve). About 30-40 seconds later, fully close the valve at low pressure side (gas valve), immediately stop the unit and disconnect power. Please note that the time for refrigerant recovery should not exceed 1 minute.**
If refrigerant recovery takes too much time, air may be sucked in and cause pressure rise or compressor rupture, resulting in injury.
- 4. During refrigerant recovery, make sure that liquid valve and gas valve are fully closed and power is disconnected before detaching the connection pipe.**
If compressor starts running when stop valve is open and connection pipe is not yet connected, air will be sucked in and cause pressure rise or compressor rupture, resulting in injury.
- 5. When installing the unit, make sure that connection pipe is securely connected before the compressor starts running.**
If compressor starts running when stop valve is open and connection pipe is not yet connected, air will be sucked in and cause pressure rise or compressor rupture, resulting in injury.
- 6. Prohibit installing the unit at the place where there may be leaked corrosive gas or flammable gas**
If there leaked gas around the unit, it may cause explosion and other accidents.
- 7. Do not use extension cords for electrical connections. If the electric wire is not long enough, please contact a local service center authorized and ask for a proper electric wire.**
Poor connections may lead to electric shock or fire.
- 8. Use the specified types of wires for electrical connections between the indoor and outdoor units. Firmly clamp the wires so that their terminals receive no external stresses.**
Electric wires with insufficient capacity, wrong wire connections and insecure wire terminals may cause electric shock or fire.

Safety Precautions for Refrigerant

- To realize the function of the air conditioner unit, a special refrigerant circulates in the system. The used refrigerant is the fluoride R32, which is specially cleaned. The refrigerant is flammable and inodorous. Furthermore, it can lead to explosion under certain conditions. But the flammability of the refrigerant is very low. It can be ignited only by fire
- Compared to common refrigerants, R32 is a nonpolluting refrigerant with no harm to the ozone layer. The influence upon the greenhouse effect is also lower. R32 has got very good thermodynamic features which lead to a really high energy efficiency. The units therefore need a less filling

WARNING:

- Do not use means to accelerate the defrosting process or to clean, other than those recommended by the manufacturer. Should repair be necessary, contact your nearest authorized Service Centre. Any repairs carried out by unqualified personnel may be dangerous. The appliance shall be stored in a room without continuously operating ignition sources. (for example: open flames, an operating gas appliance or an operating electric heater.)
- Do not pierce or burn.
- Appliance shall be installed, operated and stored in a room with a floor area larger than 4m² (or 6m²)
- Appliance filled with flammable gas R32. For repairs, strictly follow manufacturer's instructions only. Be aware that refrigerants do not contain odour.
- Read specialist's manual.

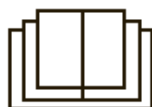

Main Tools for Installation and Maintenance

<p>1. Level meter, measuring tape</p> 	<p>2. Screw driver</p> 	<p>3. Impact drill, drill head, electric drill</p> 
<p>4. Electroprobe</p> 	<p>5. Universal meter</p> 	<p>6. Torque wrench, open-end wrench, inner hexagon spanner</p> 
<p>7. Electronic leakage detector</p> 	<p>8. Vacuum pump</p> 	<p>9. Pressure meter</p> 
<p>10. Pipe pliers, pipe cutter</p> 	<p>11. Pipe expander, pipe bender</p> 	<p>12. Soldering appliance, refrigerant container</p> 

8. Installation Manual

Installation procedures

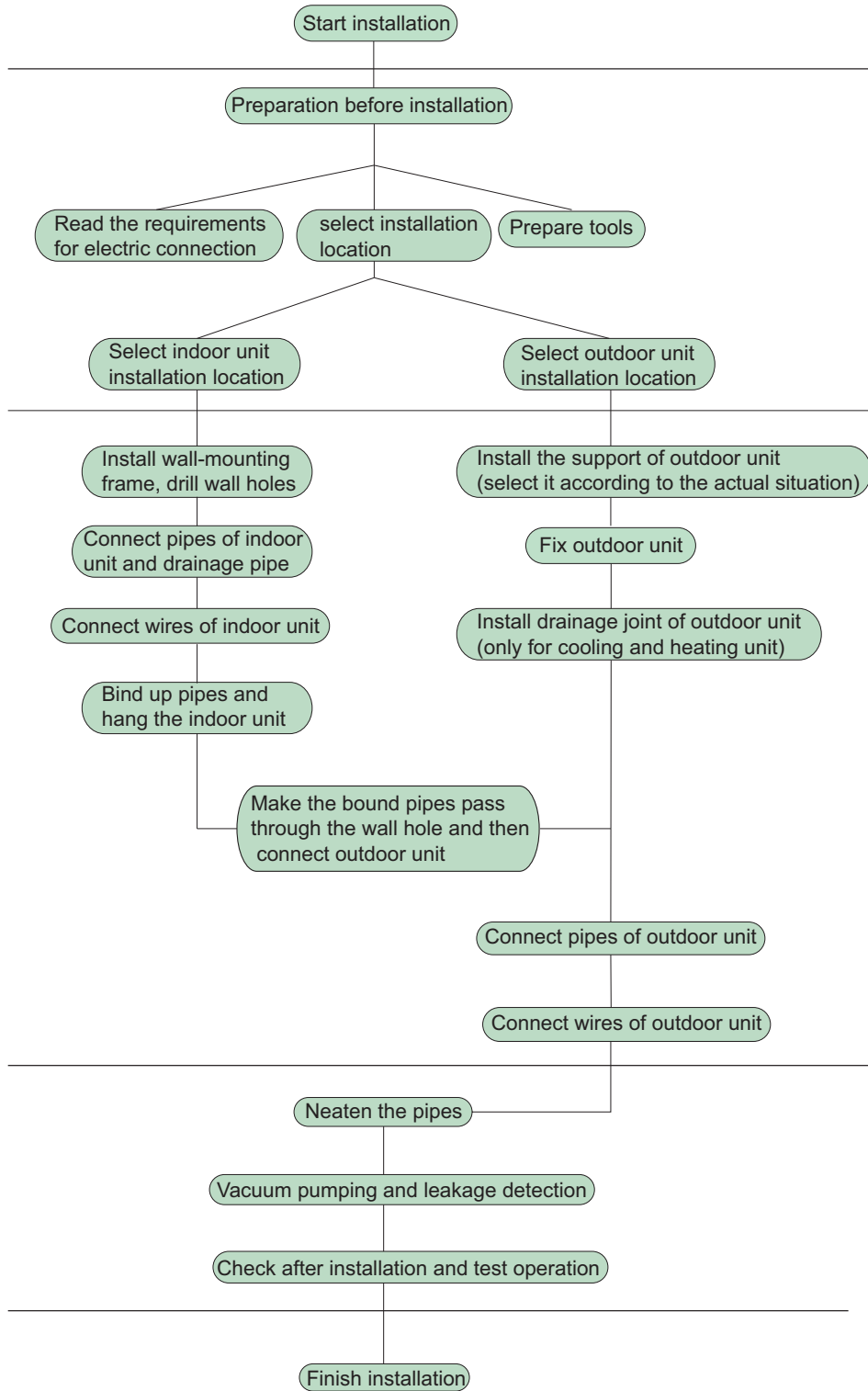

Note: this flow is only for reference; please find the more detailed installation steps in this section.

8.1 Preparation before Installation

8.1.1 Standard parts

Please use the following standard parts supplied by AZURI.

Pars of Outdoor Unit				
Number	Name	Quantity	Remark	
1	Owner's manual	1		
2	Tube connector subassy	6		

8.1.2 Selecting installation site



Forbidden Items! It indicates that improper operation might lead to human casualty or sever injury.



Items need to be followed. It indicates that improper operation might lead to personal injury or property damage.

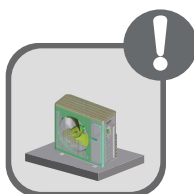

Install the unit at a place where is adequa to withstand the weight of the unit and make sure the unit would not shake or fall off.

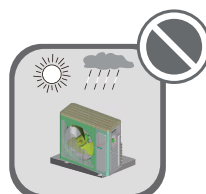

Never expose the unit under direct sunshine and rainfull. install the unit at a place where is against dust, typhoon and earthquake.



Try to keep the unit away from combustibile, inflammable and corrosive gas or exhaust gas.

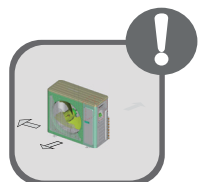

Leave some space for heat exchanging and servicing so as to guarantee unit normal operation.



Keep the indoor and outdoor units close to each other as much units close to each other as much the pipe length and bends.



Never allow children to approach to the unit and take measures to prevent children touching the unit.

8.2 Installation Instruction

8.2.1 Outline and dimension of the outdoor unit

AZI-OR100VB/O

Outline dimension and Mounting holes

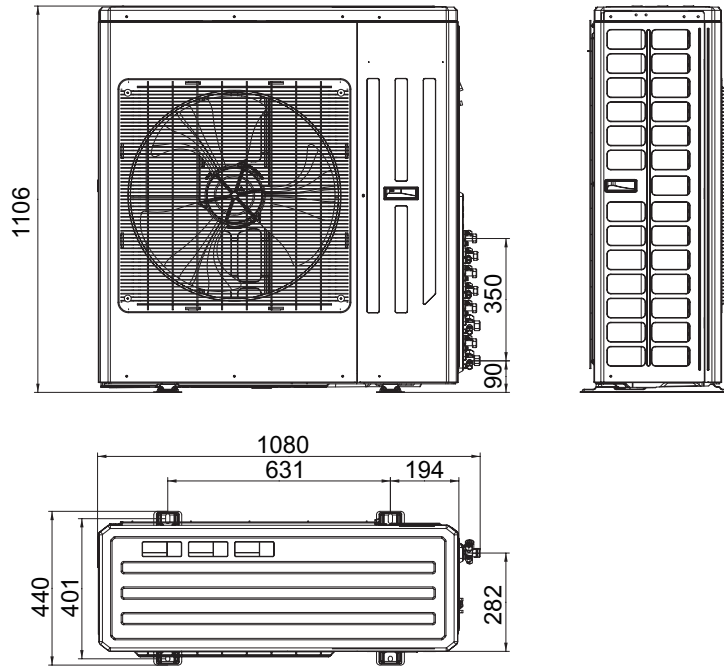

Fig.2

AZI-OR120VB/O

Outline dimension and Mounting holes

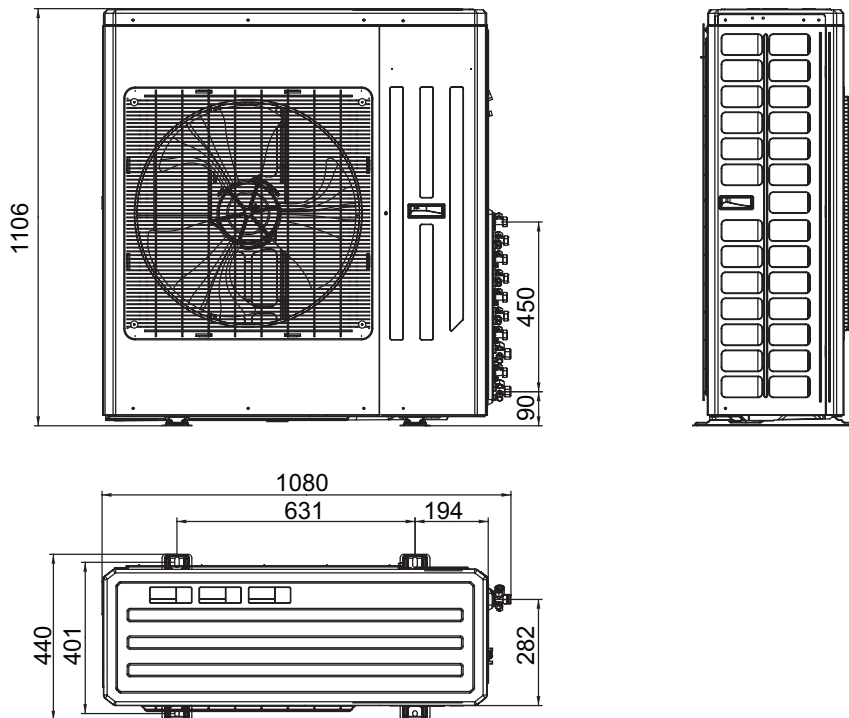

Fig.3

2) Allowable pipe length and drop height among indoor and outdoor units

If the total refrigerant pipe length (liquid pipe) is smaller than that listed in the table below, no additional refrigerant will be charged.

Model	AZI-OR100VB/O	AZI-OR120VB/O
Total Liquid Pipe Length (a+b+c+d+e)	40	40

Allowable Length and Height Fall of the Refrigerant Pipe

		Allowable Value		Fitting pipe
		AZI-OR100VB/O	AZI-OR120VB/O	
Total length(actual length) of fitting pipe		75m	75m	$L_1+L_2+\dots+L_M (M \leq 5)$
length of farthest fitting pipe(ft)		25m	25m	$L_x (X=1, 2, 3, 4, 5)$
Height difference between outdoor unit and indoor unit	Outdoor unit at upper	15m	15m	H1
	Outdoor unit at lower	15m	15m	H3
Height difference between indoor units(ft)		7.5m	7.5m	H2

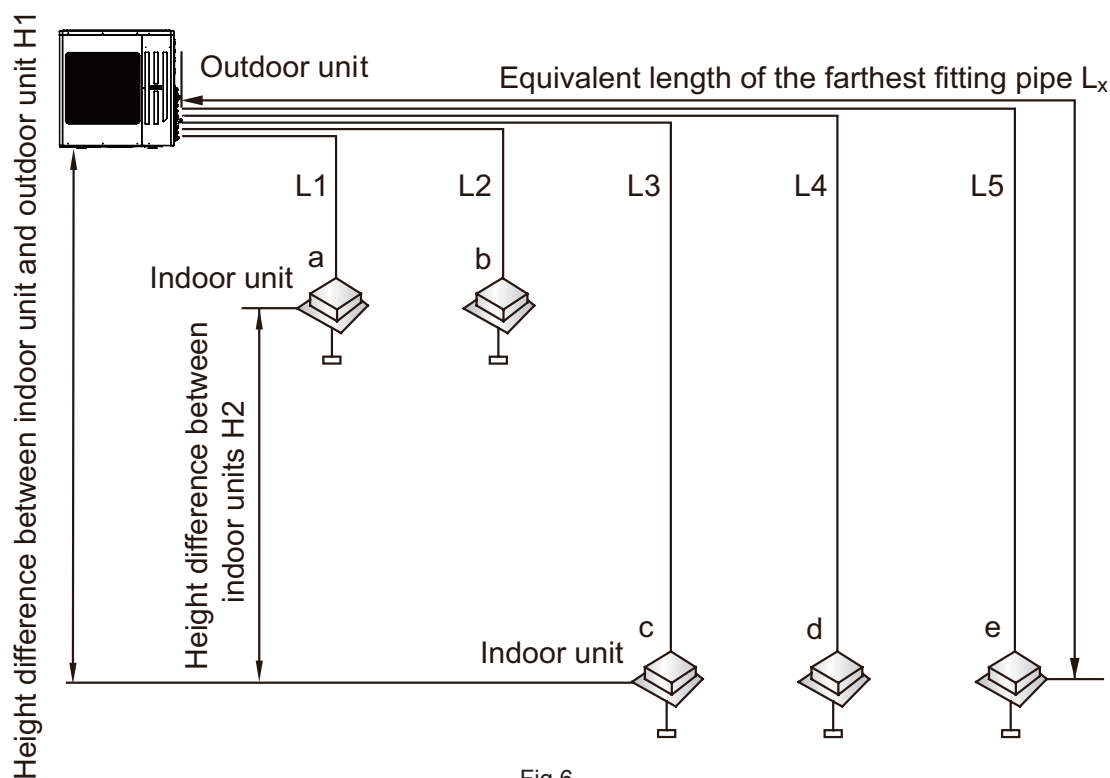
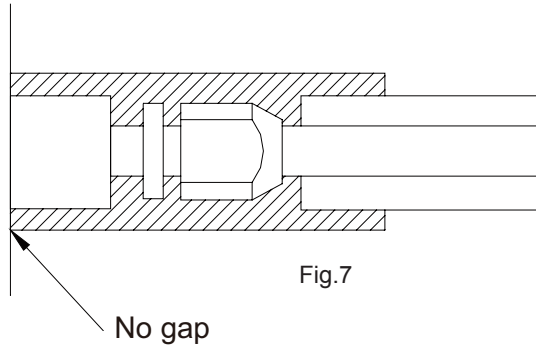

Fig.6

3) Installation of the Protection Layer of the Refrigerant Pipe

- a. The refrigerant pipe should be insulated by the insulating material and plastic tape in order to prevent condensation and water leakage.
- b. The joints of the indoor unit should be wrapped with the insulating material and no gap is allowed on the joint of the indoor unit, as shown in Fig.7.



⚠ CAUTION!

After the pipe is protected well enough, never bend it to form a small angle; otherwise it would crack or break.

4) Wrap the Pipe with Tape:

- a. Bundle the refrigerant pipe and electric wire together with tape, and separate them from the drain pipe to prevent the condensate water overflowing.
- b. Wrap the pipe from the bottom of the outdoor unit to the top of the pipe where it enters the wall. During the wrapping, the later circle should cover half of the former one.
- c. Fix the wrapped pipe on the wall with clamps.

⚠ CAUTION!

- ① . Do not wrap the pipe too tightly; otherwise the insulation effect would be weakened. Additionally, make sure the drain hose is separated from the pipe.
 - ② .After that, fill the hole on the wall with sealing material to prevent wind and rain coming into the room.
- (4) Support and protection for pipeline Support should be made for hanging connection pipe. Distance between each support can not be over 1m.

8.2.3 Air Purging and Refrigerant Charge

Air purging

- 1) The refrigerant has been charged into the outdoor unit before shipment, while additional refrigerant still need be charged into the refrigerant pipe during the field installation.
- 2) Check if the liquid valve and the gas valve of the outdoor unit are closed fully.
- 3) As shown in the following figure (Fig.8), expel the gas inside the indoor unit and refrigerant pipe out by the vacuum pump.

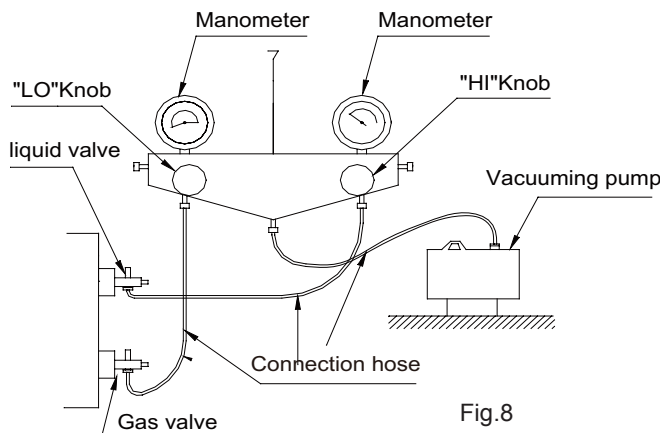

- 4) When the compressor is not running, charge the R410A refrigerant into the refrigerant pipe from the liquid valve of the outdoor unit (do not do it from the gas valve).

Additional refrigerant charging

- a. Refrigerant Charge in the Outdoor Unit before Shipment

Notes:

- ① . Outdoor unit has been charged refrigerant before delivery. The refrigerant charge is not included those charged additionally in the



indoor unit and the refrigerant pipe.

② . The amount of the additional refrigerant charge is dependent on the diameter and length of the liquid refrigerant pipe which is decided by the actual yield installation requirement.

③ . Record the additional refrigerant charge for future maintenance.

b. Calculation of the Additional Refrigerant Charge

$$\text{Additional Refrigerant Charge} = (\Sigma \text{Length of Liquid Pipe } \Phi 9.52 \times 54 + \Sigma \text{Length of Liquid Pipe } \Phi 6.35 \times 22) - 880$$

The biggest additional refrigerant charge value is 800g. It means that if the calculated value exceed 800g, the additional refrigerant charge takes 800g, while the calculated value less than 800g, the additional refrigerant charge takes the calculated value.

8.2.4 Electric Wiring

1) Wiring precautions

- The installation must be done in accordance with the national wiring regulations.
- Only the power cord with the rated voltage and exclusive circuit for the air conditioning can be used.
- Do not pull the power cord by force.
- The electric installation should be carried out by the technician as instructed by the local laws, regulations and also this manual.
- The diameter of the power cord should be large enough and once it is damaged it must be replaced by the dedicated one.
- The earthing should be reliable and the earth wire should be connected to the dedicated device of the building by the technician. Besides, the air switch coupled with the leakage current protection switch must be equipped, which is of enough capacity and of both magnetic and thermal tripping functions in case of the short circuit and overload.

Models	Power Supply	Capacity of the air Switch(A)	Recommended Cord(pieces sectional area)
AZI-OR100VB/O	220-240V~,50Hz	32	3x4mm ²
AZI-OR120VB/O	220-240V~,50Hz	32	3x4mm ²

AZI-OR100VB/O

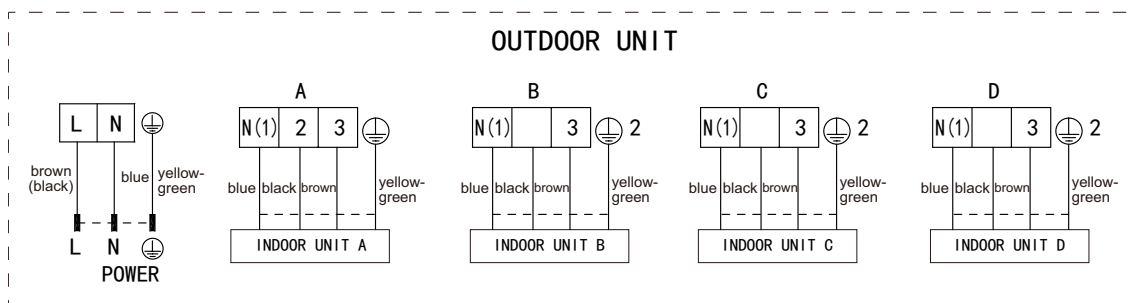

AZI-OR120VB/O

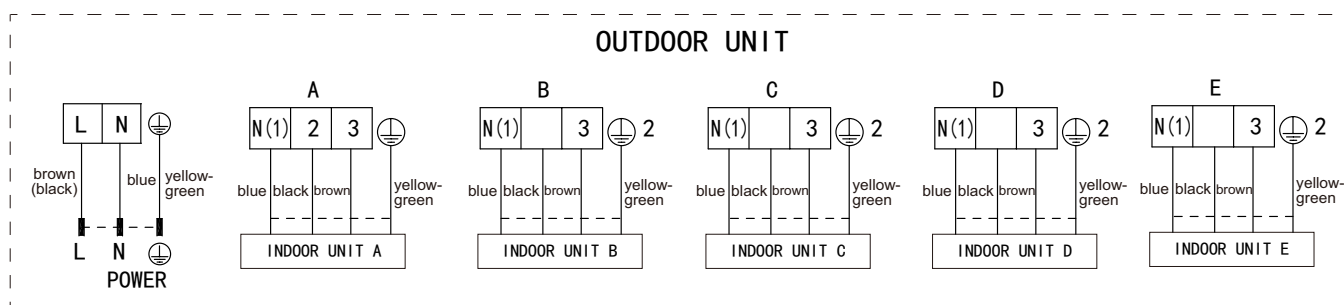

2) Earthing Requirements

- The air conditioner is classified into the Class I appliances, so its earthing must be reliable.
- The yellow-green line of the air conditioner is the earth line and can not be used for other purpose, cut off or fixed by the tapping screw; otherwise it would cause the hazard of electric shock.
- The reliable earth terminal should be provided and the earth wire can not be connected to any of the following places.
① Running water pipe; ② Coal gas pipe; ③ Sewage pipe; ④ Other places where the professional personnel think unreliable.

3) Electrical Cable Connection Cautions!

- ① . The mistake connecting line will result in malfunction. After the electrical wiring working, ensure the wire between the connection place and the fixed place has a certain freedom degree.
- ② . The connection piping and connection line of each indoor unit should connect well according to the instruction.
- ③ . The electric installation should be carried out by the technician as instructed by the local laws, regulations and also this manual.
- ④ . The installation location should be dry, and can't be expose in direct sunlight or strong breeze.
- ⑤ . Have to install a breaker in the circuit that can shut off the main power supply of the system. Besides, the air switch coupled with the leakage current protection switch must be equipped.

4) Wiring of the Power Cord

- ① . Open the side plate.
- ② . Connect the power card to the terminals "L1", "L2" and also the earthing bolt, and then connect the wiring terminals "N(1),2,3" of the indoor unit to those of the outdoor unit correspondingly.
- ③ . Fix the power cord with wire clips.
- ④ . Let the power cord go through the rubber ring.
- ⑤ . Supply cords of parts of appliances for outdoor use shall not be lighter than polychloroprene sheathed flexible cord(code designation 60245 IEC 57).

CAUTIONS!

If the supply cord is damaged, it must be replaced by the manufacturer or its service agent or a similarly qualified person in order to avoid a hazard.

9. Troubleshooting

9.1 Malfunction Indicator

The error code will be displayed on the wired controller and the main board of the outdoor unit.

The meaning of each error, as shown in table 13.

Name of malfunction	The indicator display			Indoor display
	Yellow light	Red light	Green light	
Compressor runs	Flash once			
Defrost	Flash twice			H1
Anti-freezing protection	Flash 3 times			E2
IPM protection	Flash 4 times			H5
AC over-current protection	Flash 5 times			E5
Over-burden protection	Flash 6 times			H4
Compressor exhaust high temperature protection	Flash 7 times			E4
Compressor overload protection	Flash 8 times			H3
Power protection	Flash 9 times			L9
EEPROM reads and write protection	Flash 11 times			
Low PN voltage protection	Flash 12 times			PL
Over voltage protection for PN	Flash 13 times			PH
PFC protection	Flash 14 times			HC
PFC module temperature protection	Flash 15 times			oE
Low pressure protection	Flash 17 times			E3
High pressure protection	Flash 18 times			E1
Limit/decline frequency(electric current)		Flash 1 times		
Frequency limit(exhaust)		Flash 2 times		
Frequency limit(Over-burden)		Flash 3 times		
Outdoor ambient sensor malfunction		Flash 6 times		F3
Outdoor tube sensor malfunction		Flash 5 times		F4
Exhaust sensor malfunction		Flash 7 times		F5
Attain the temperature of switch on		Flash 8 times		
Frequency limit(power)		Flash 13 times		
Outdoor fan malfunction		Flash 14 times		
Frequency limit(PFC module temperature)		Flash 15 times		
PFC module sensor malfunction		Flash 16 times		oE
Liquid pipe temperature sensor malfunction of A		Flash 17 times		

Gas pipe temperature sensor malfunction of A		Flash 18 times		
Liquid pipe temperature sensor malfunction of B		Flash 19 times		
Gas pipe temperature sensor malfunction of B		Flash 20 times		
Liquid pipe temperature sensor malfunction of C		Flash 21 times		
Gas pipe temperature sensor malfunction of C		Flash 22 times		
Liquid pipe temperature sensor malfunction of D		Flash 23 times		
Gas pipe temperature sensor malfunction of D		Flash 24 times		
Liquid pipe temperature sensor malfunction of E		Flash 25 times		
Gas pipe temperature sensor malfunction of E		Flash 26 times		
Exit of the condenser tube sensor malfunction		Flash 27 times		
Correspondence is normal			Flash 7 times(n=indoor unit number)	
Communication failure between indoor unit and outdoor unit			Often bright (indoor unit all Communication failure)	
Indoor ambient sensor malfunction				F1
Indoor evaporate sensor malfunction				F2
Mode conflict				E7
Accept fluorine mode				Fo
Jumper cap malfunction protection				C5
Anti-freezing protection				FH

9.2 Malfunction Checking and Elimination

1 IPM protection malfunction:

Main checking point:

- If the input voltage of the unit is within normal range?
- If the connection wire of compressor is connected well? Is it loose? If the connection sequence is correct?
- If the resistance of compressor coil is normal? If the isolation of compressor coil with copper pipe is good?
- If the unit is overloaded? If the heat radiation of the unit is good?
- If the refrigerant charge is suitable?

Flow chart:

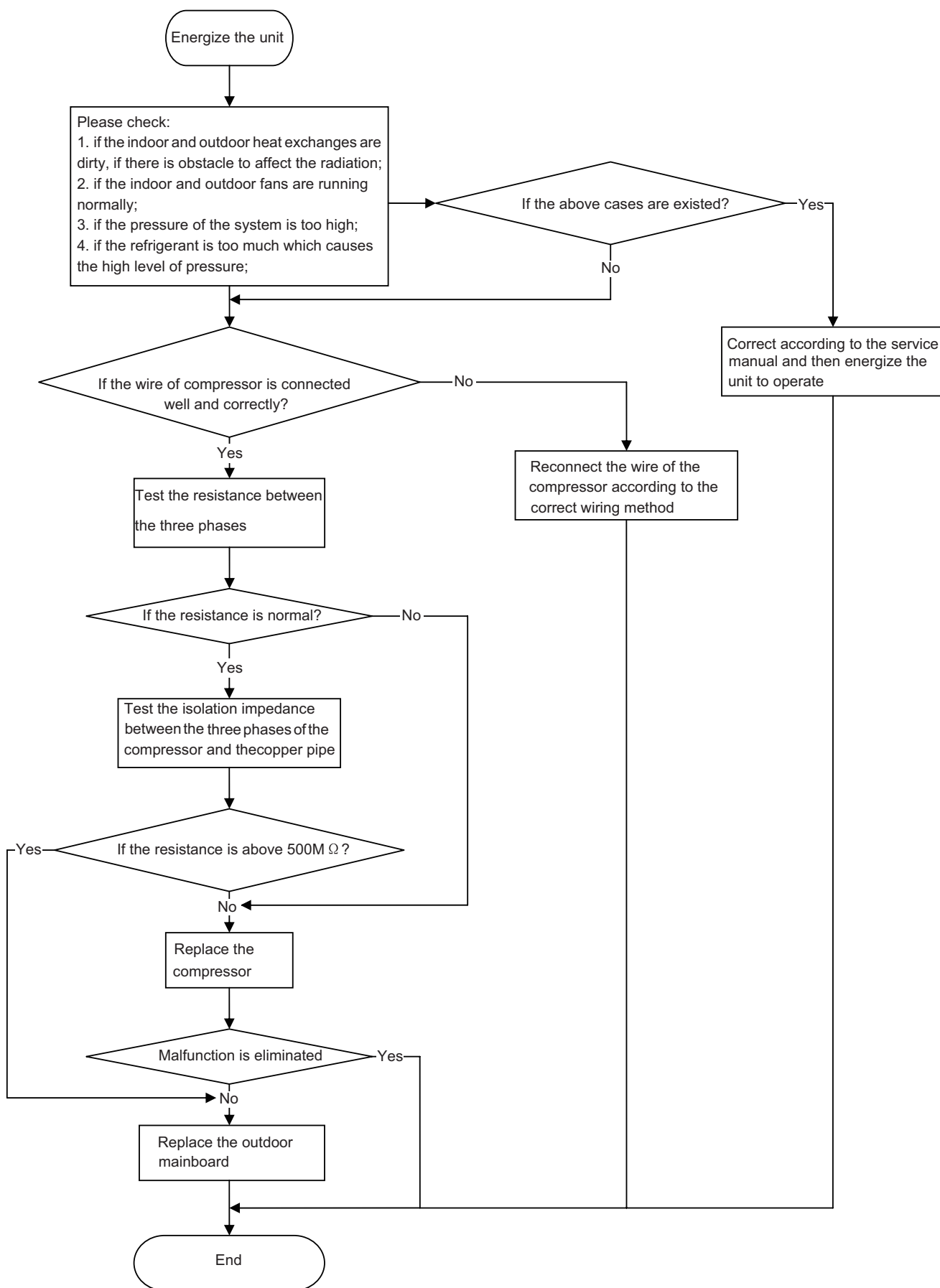

2. PFC protection malfunction, capacity charging malfunction

Main checking points:

- If the wiring of the induction is connected well and if the induction is broken;
- If the mainboard is broken;

Flow chart:

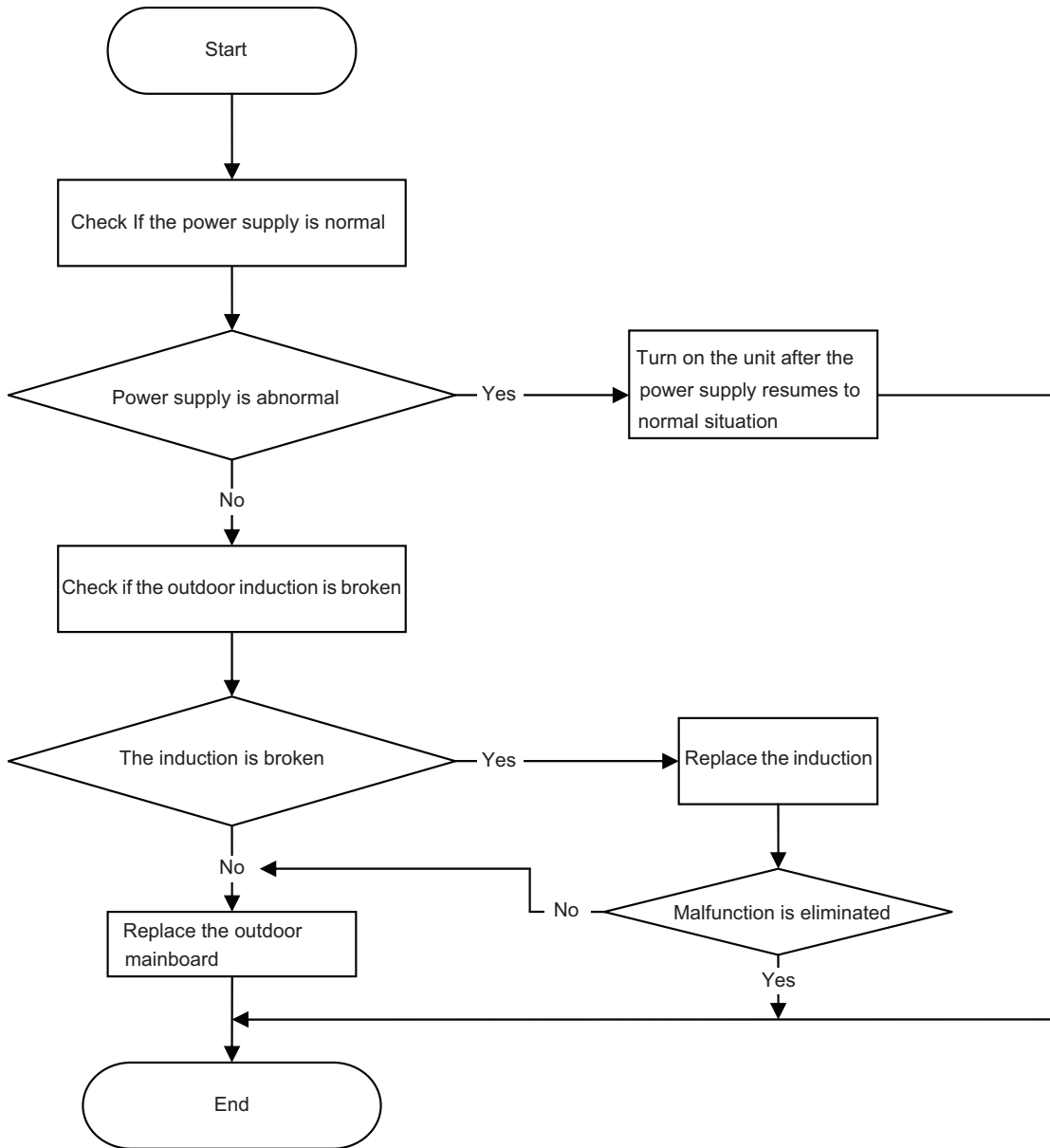

3. Compressor desynchronizing malfunction

Main checking points:

- If the pressure of the system is too high;
- If the electric expansion valve is working normally or it is broken;
- If the radiation of the unit is good;

Flow chart:

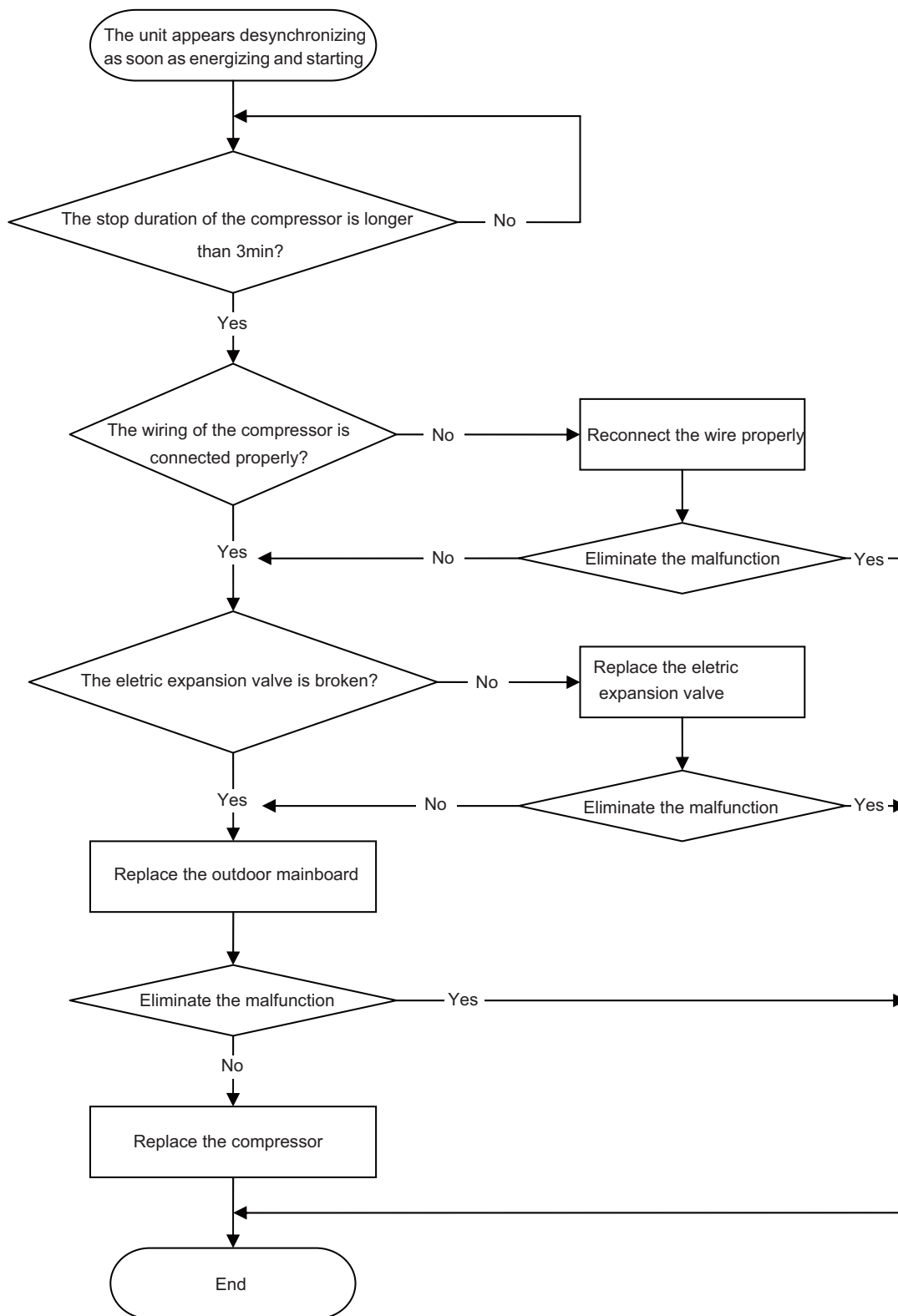

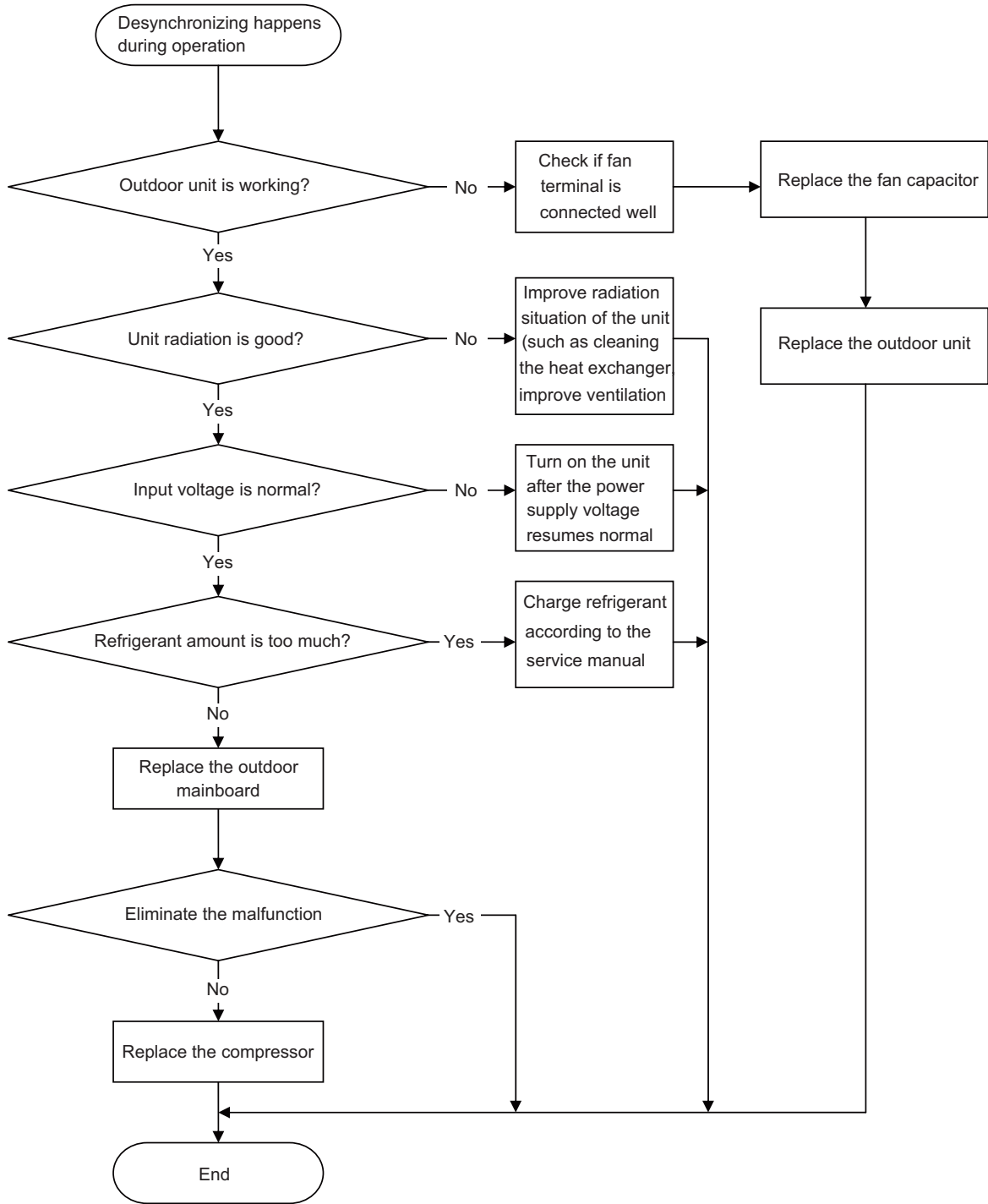

4. Compressor overload, discharge protection malfunction

Main checking points:

- If the electric expansion valve is connected well or it is broken;
- If there is refrigerant leakage;
- If the overload protector is broken;

Flow chart:

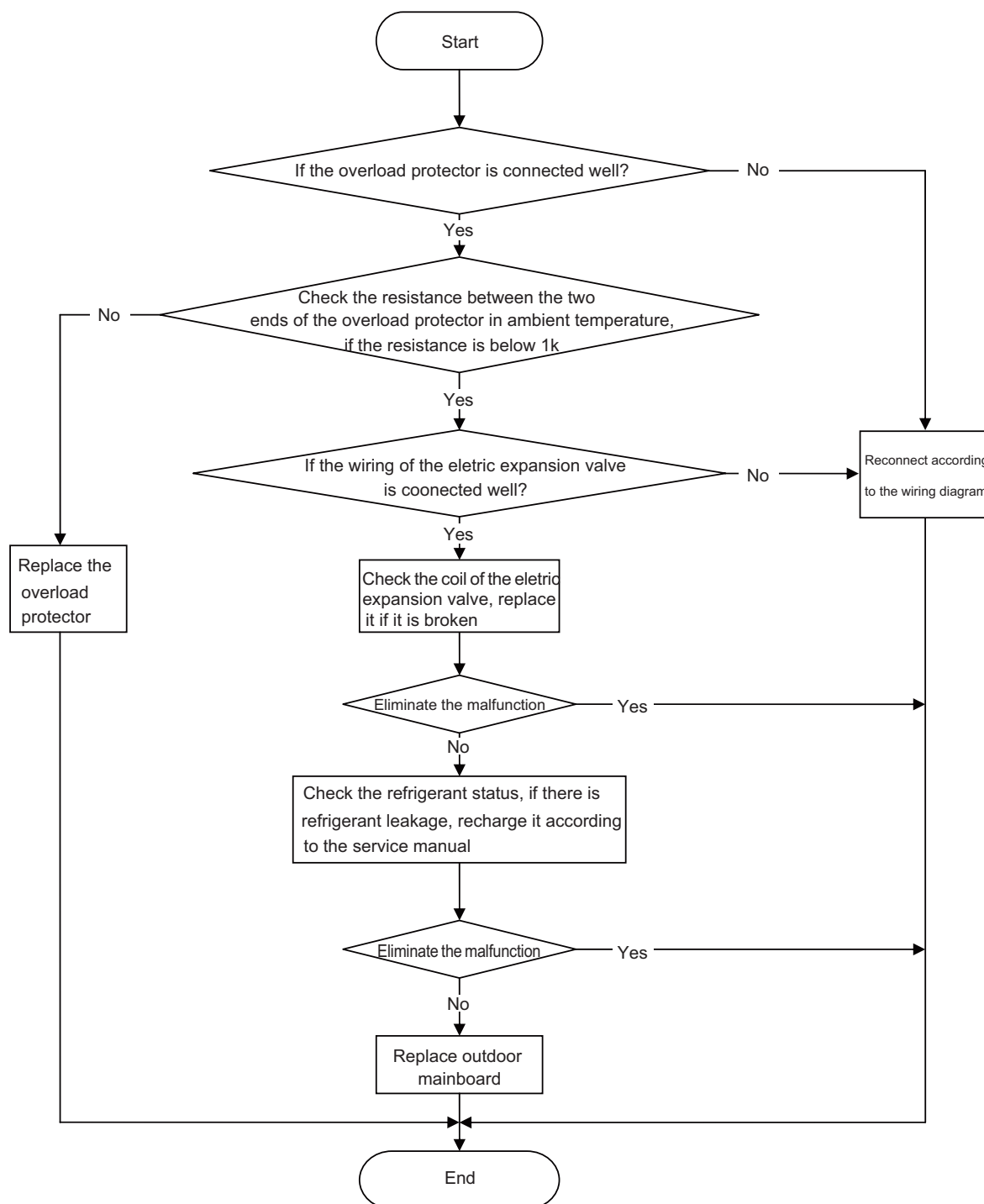

Note: the detection method of the coil of the electric expansion valve: there is five pieces of coil of the electric expansion valve, the resistance of one of them (the leftmost or the rightmost one) is almost the same as the resistance of other terminal (within 100 Ω). Judge the condition of the electronic expansion valve through detecting these resistance.

5. Start failure malfunction

Main checking points:

- If the connection wire of the compressor is connected properly;
- If the stop duration of the compressor is sufficient;
- If the compressor is broken;
- If the refrigerant charging amount is too much;

Flow chart:

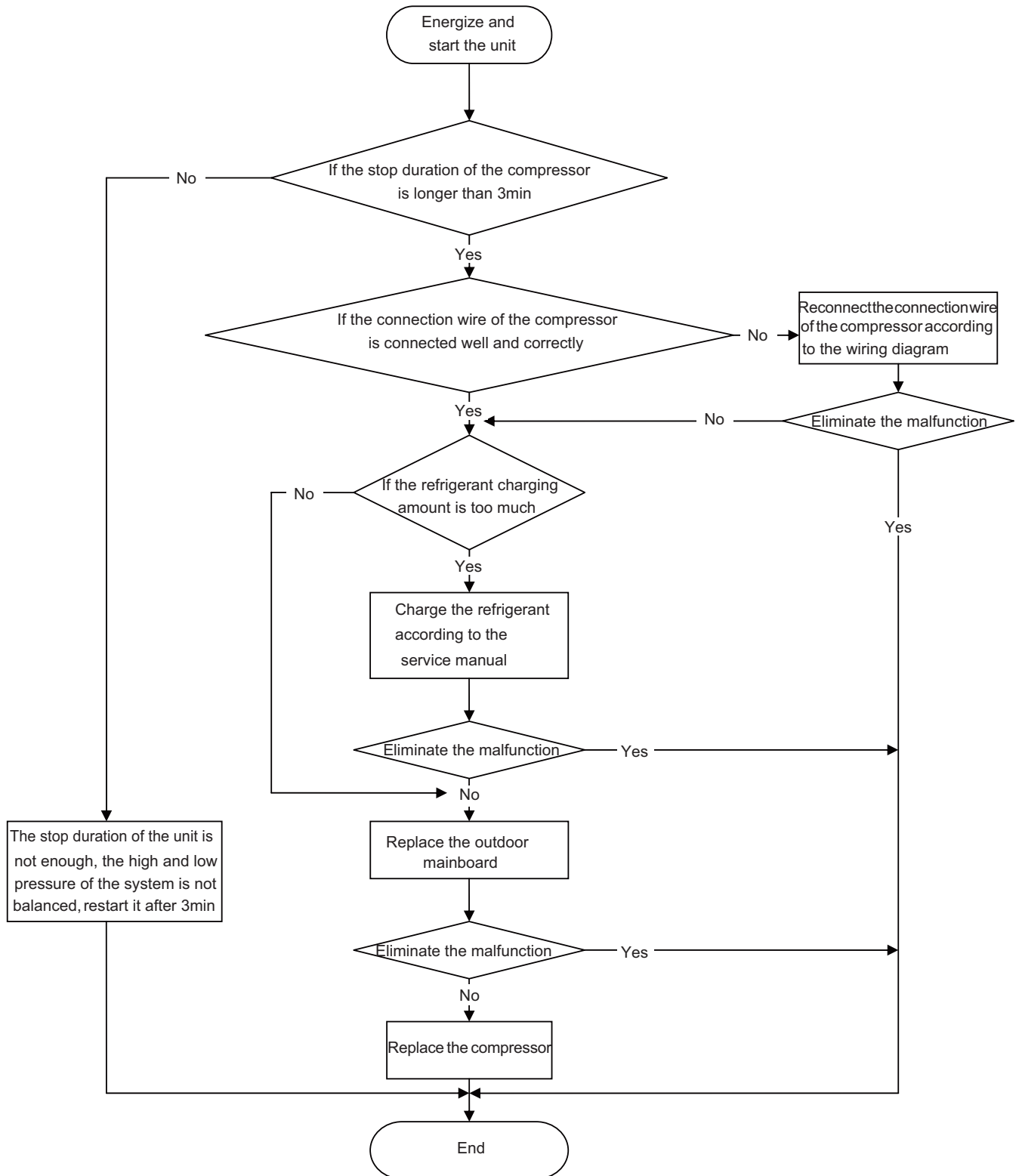

6. Temperature sensor malfunction

Main checking points:

- If the temperature sensor is damaged or broken
- If the terminal of the temperature sensor is loosened or not connected;
- If the mainboard is broken;

Flow chart:

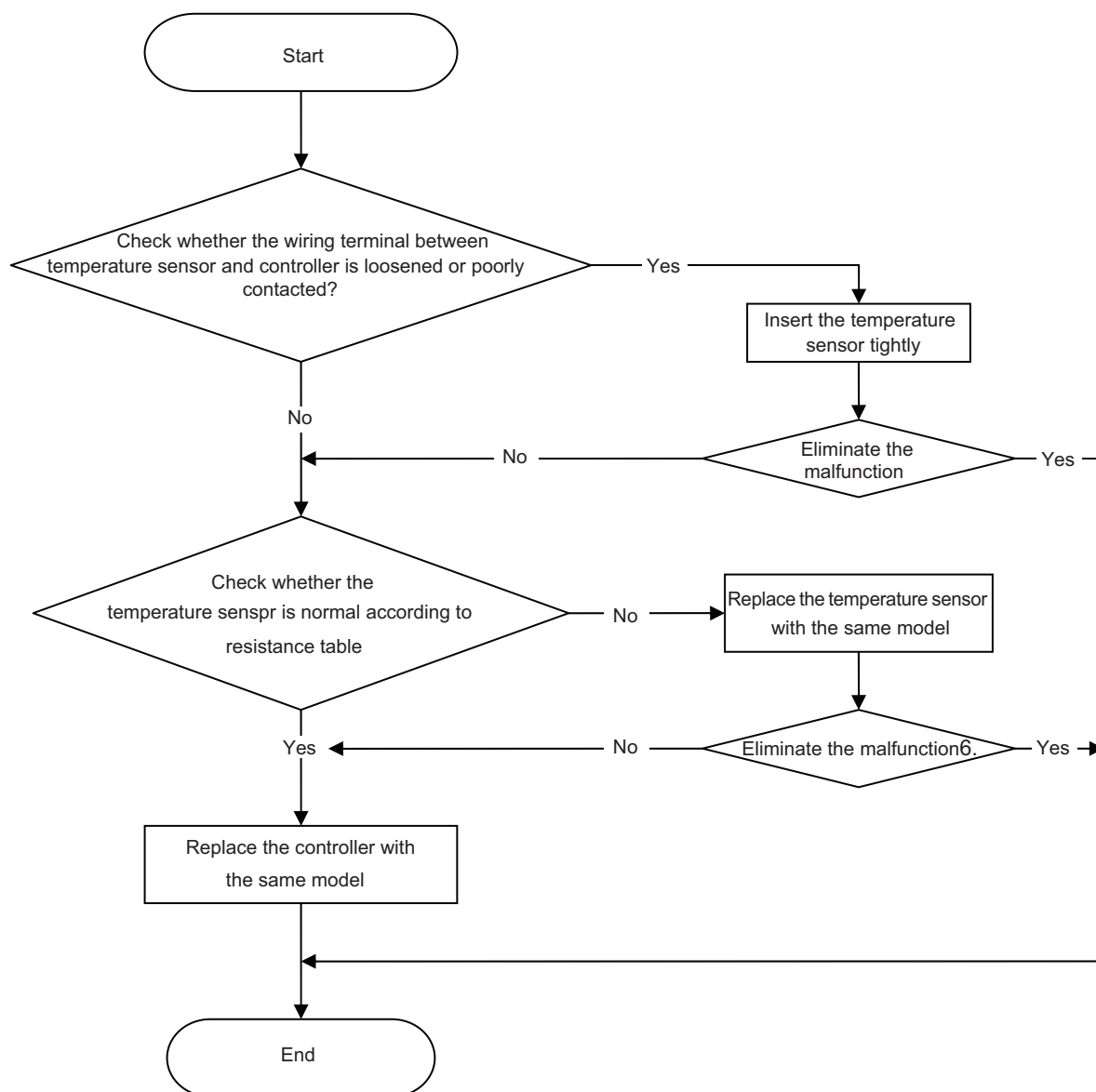

8. Communication malfunction

Main checking points:

- If the connection wire between the indoor unit and outdoor unit is connected well, if the wires inside the unit is connected well;
- If the indoor mainboard or outdoor main board is broken;

Flow chart:

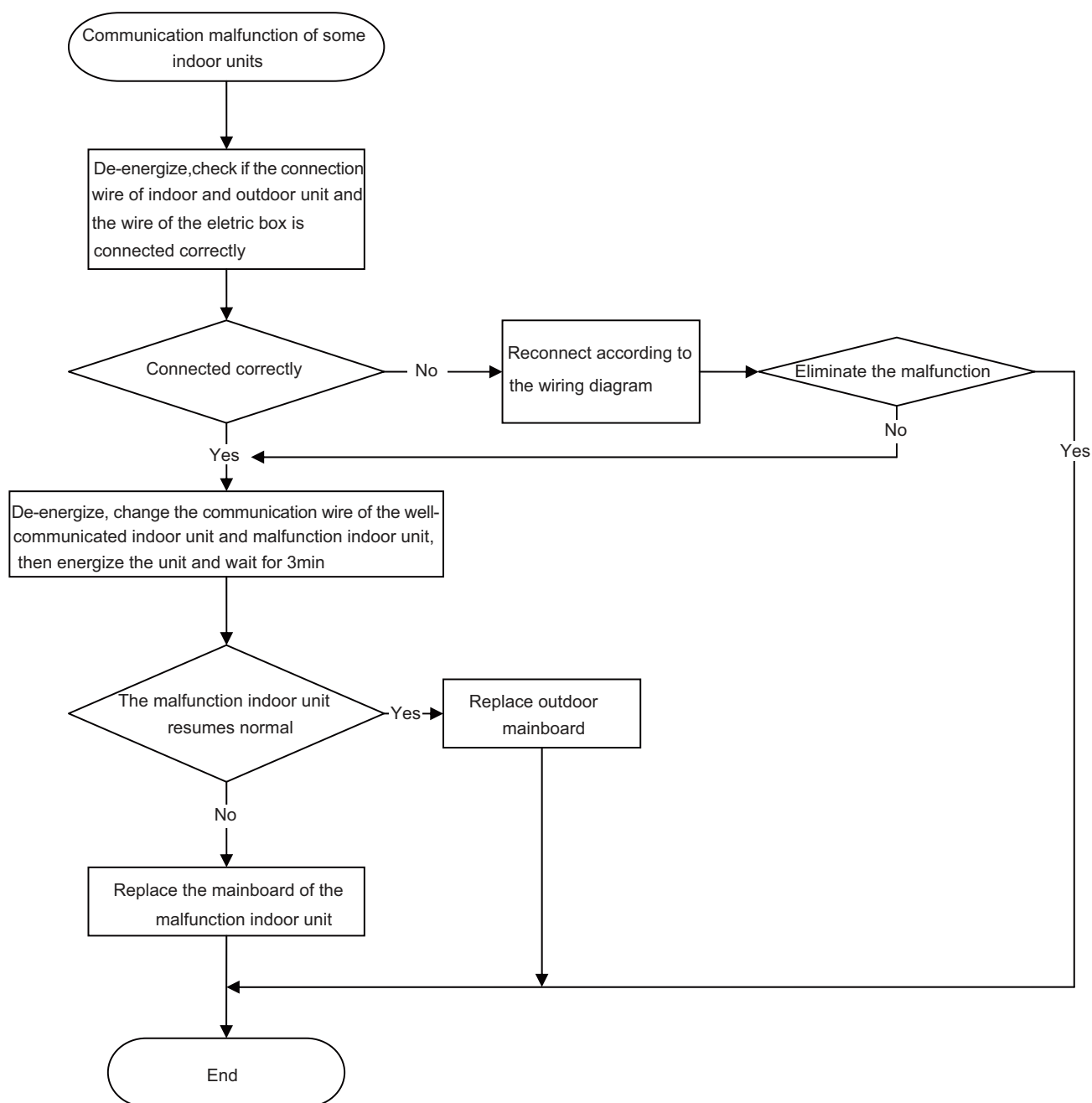

9. Anti-high temperature and overload malfunction

Main checking points:

- If the outdoor ambient temperature is within the normal range;
- If the indoor fan and outdoor fan are running normally;
- If the indoor and outdoor radiation environment is good;

Flow chart:

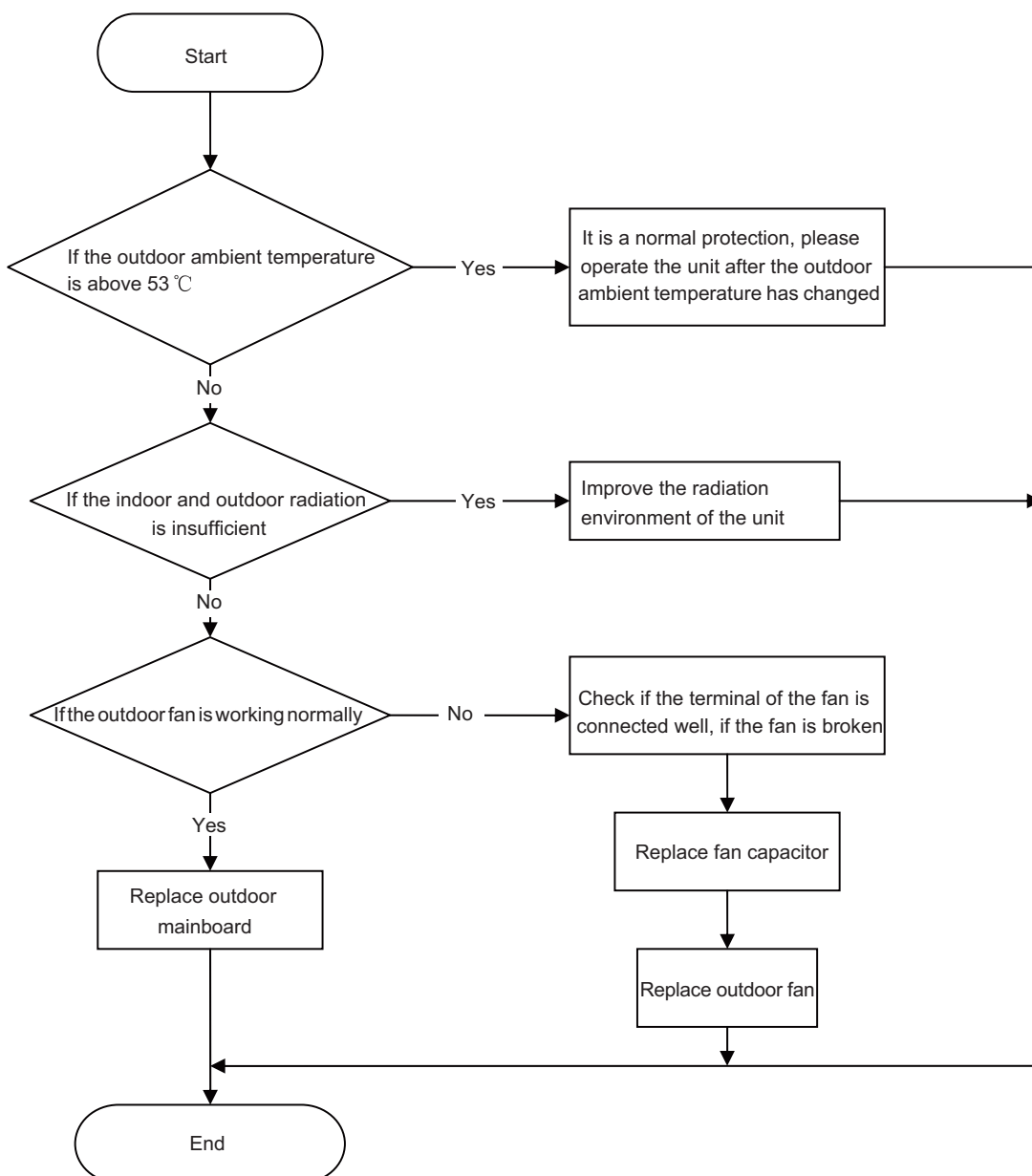

9.3 Maintenance Method for Normal Malfunction

1. Air Conditioner Can't be Started Up

Possible Causes	Discriminating Method (Air conditioner Status)	Troubleshooting
No power supply, or poor connection for power plug	After energization, operation indicator isn't bright and the buzzer can't give out sound	Confirm whether it's due to power failure. If yes, wait for power recovery. If not, check power supply circuit and make sure the power plug is connected well.
Wrong wire connection between indoor unit and outdoor unit, or poor connection for wiring terminals	Under normal power supply circumstances, operation indicator isn't bright after energization	Check the circuit according to circuit diagram and connect wires correctly. Make sure all wiring terminals are connected firmly
Electric leakage for air conditioner	After energization, room circuit breaker trips off at once	Make sure the air conditioner is grounded reliably Make sure wires of air conditioner is connected correctly Check the wiring inside air conditioner. Check whether the insulation layer of power cord is damaged; if yes, place the power cord.
Model selection for air switch is improper	After energization, air switch trips off	Select proper air switch

2. Poor Cooling (Heating) for Air Conditioner

Possible Causes	Discriminating Method (Air conditioner Status)	Troubleshooting
Set temperature is improper	Observe the set temperature on remote controller	Adjust the set temperature
Rotation speed of the IDU fan motor is set too low	Small wind blow	Set the fan speed at high or medium
Filter of indoor unit is blocked	Check the filter to see it's blocked	Clean the filter
Installation position for indoor unit and outdoor unit is improper	Check whether the installation position is proper according to installation requirement for air conditioner	Adjust the installation position, and install the rainproof and sunproof for outdoor unit
Refrigerant is leaking	Discharged air temperature during cooling is higher than normal discharged wind temperature; Discharged air temperature during heating is lower than normal discharged wind temperature; Unit's pressure is much lower than regulated range	Find out the leakage causes and deal with it. Add refrigerant.
Malfunction of 4-way valve	Blow cold wind during heating	Replace the 4-way valve
Malfunction of capillary	Discharged air temperature during cooling is higher than normal discharged wind temperature; Discharged air temperature during heating is lower than normal discharged wind temperature; Unit's pressure is much lower than regulated range. If refrigerant isn't leaking, part of capillary is blocked	Replace the capillary
Flow volume of valve is insufficient	The pressure of valves is much lower than that stated in the specification	Open the valve completely
Malfunction of horizontal louver	Horizontal louver can't swing	Refer to point 3 of maintenance method for details
Malfunction of the IDU fan motor	The IDU fan motor can't operate	Refer to troubleshooting for H6 for maintenance method in details
Malfunction of the ODU fan motor	The ODU fan motor can't operate	Refer to point 4 of maintenance method for details
Malfunction of compressor	Compressor can't operate	Refer to point 5 of maintenance method for details

3. Horizontal Louver Can't Swing

Possible Causes	Discriminating Method (Air conditioner Status)	Troubleshooting
Wrong wire connection, or poor connection	Check the wiring status according to circuit diagram	Connect wires according to wiring diagram to make sure all wiring terminals are connected firmly
Stepping motor is damaged	Stepping motor can't operate	Repair or replace stepping motor
Main board is damaged	Others are all normal, while horizontal louver can't operate	Replace the main board with the same model

4. ODU Fan Motor Can't Operate

Possible causes	Discriminating method (air conditioner status)	Troubleshooting
Wrong wire connection, or poor connection	Check the wiring status according to circuit diagram	Connect wires according to wiring diagram to make sure all wiring terminals are connected firmly
Capacity of the ODU fan motor is damaged	Measure the capacity of fan capacitor with an universal meter and find that the capacity is out of the deviation range indicated on the nameplate of fan capacitor.	Replace the capacity of fan
Power voltage is a little low or high	Use universal meter to measure the power supply voltage. The voltage is a little high or low	Suggest to equip with voltage regulator
Motor of outdoor unit is damaged	When unit is on, cooling/heating performance is bad and ODU compressor generates a lot of noise and heat.	Change compressor oil and refrigerant. If no better, replace the compressor with a new one

5. Compressor Can't Operate

Possible causes	Discriminating method (air conditioner status)	Troubleshooting
Wrong wire connection, or poor connection	Check the wiring status according to circuit diagram	Connect wires according to wiring diagram to make sure all wiring terminals are connected firmly
Capacity of compressor is damaged	Measure the capacity of fan capacitor with an universal meter and find that the capacity is out of the deviation range indicated on the nameplate of fan capacitor.	Replace the compressor capacitor
Power voltage is a little low or high	Use universal meter to measure the power supply voltage. The voltage is a little high or low	Suggest to equip with voltage regulator
Coil of compressor is burnt out	Use universal meter to measure the resistance between compressor terminals and it's 0	Repair or replace compressor
Cylinder of compressor is blocked	Compressor can't operate	Repair or replace compressor

6. Air Conditioner is Leaking

Possible causes	Discriminating method (air conditioner status)	Troubleshooting
Drain pipe is blocked	Water leaking from indoor unit	Eliminate the foreign objects inside the drain pipe
Drain pipe is broken	Water leaking from drain pipe	Replace drain pipe
Wrapping is not tight	Water leaking from the pipe connection place of indoor unit	Wrap it again and bundle it tightly

7. Abnormal Sound and Vibration

Possible causes	Discriminating method (air conditioner status)	Troubleshooting
When turn on or turn off the unit, the panel and other parts will expand and there's abnormal sound	There's the sound of "PAPA"	Normal phenomenon. Abnormal sound will disappear after a few minutes.
When turn on or turn off the unit, there's abnormal sound due to flow of refrigerant inside air conditioner	Water-running sound can be heard	Normal phenomenon. Abnormal sound will disappear after a few minutes.
Foreign objects inside the indoor unit or there're parts touching together inside the indoor unit	There's abnormal sound fro indoor unit	Remove foreign objects. Adjust all parts' position of indoor unit, tighten screws and stick damping plaster between connected parts
Foreign objects inside the outdoor unit or there're parts touching together inside the outdoor unit	There's abnormal sound fro outdoor unit	Remove foreign objects. Adjust all parts' position of outdoor unit, tighten screws and stick damping plaster between connected parts
Short circuit inside the magnetic coil	During heating, the way valve has abnormal electromagnetic sound	Replace magnetic coil
Abnormal shake of compressor	Outdoor unit gives out abnormal sound	Adjust the support foot mat of compressor, tighten the bolts
Abnormal sound inside the compressor	Abnormal sound inside the compressor	If add too much refrigerant during maintenance, please reduce refrigerant properly. Replace compressor for other circumstances.

1\$. Removal Procedure



Warning: Be sure to wait for a minimum of 20 minutes after turning off all power supplies and discharge the refrigerant completely before removal.

ÖZÜFÖÖÖÖÖÖ ÖZÜFÖÖÖÖÖÖ
NOTE: Take ÖZÜFÖÖÖÖÖÖ for example.

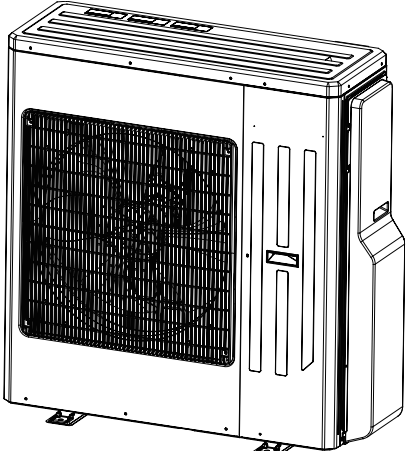
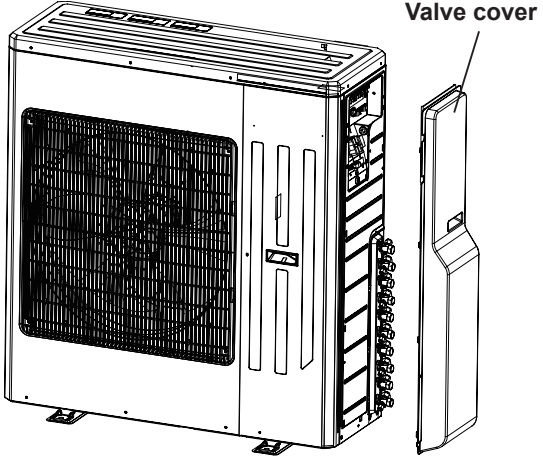
Steps	Procedure
<p>1. Before disassembly</p>	<p>Complete axonometric drawing.</p> 
<p>2. Remove valve cover</p>	<p>Remove the connection screw fixing the valve cover and then remove the valve cover.</p> 

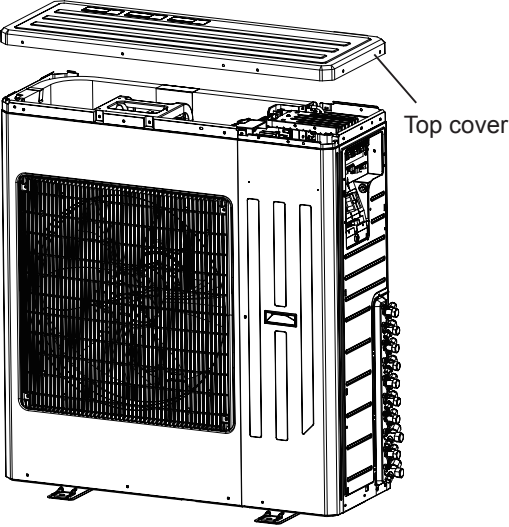
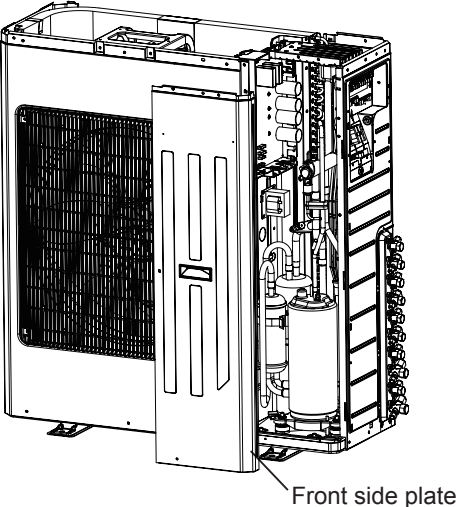
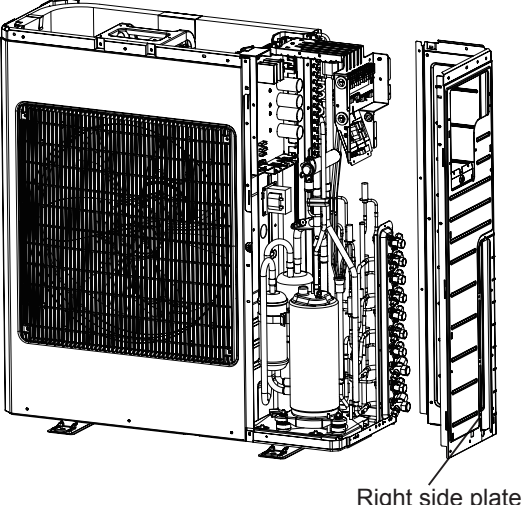
Steps	Procedure
3. Remove top cover	<p>Remove the screws connecting the top cover with outer case, right side plate and left side plate; lift the top cover upwards to remove it.</p> 
4. Remove front side plate	<p>Remove the screws connecting the front side plate with chassis and middle isolation sheet, and then remove the front side plate.</p> 
5. Remove right side plate	<p>Remove the screws connecting the right side plate with electric box assy, valve support, chassis and condenser side plate, and then remove the right side plate.</p> 

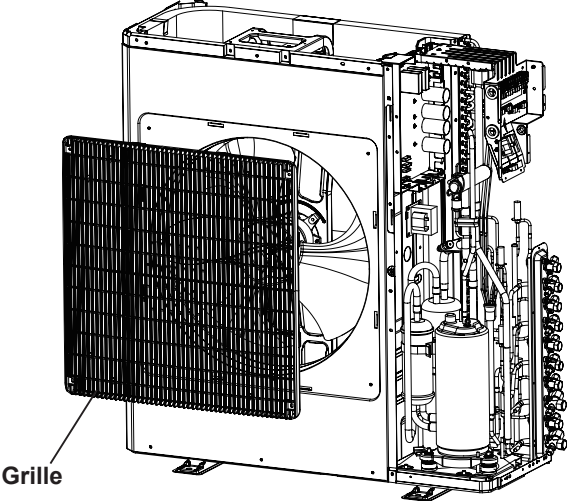
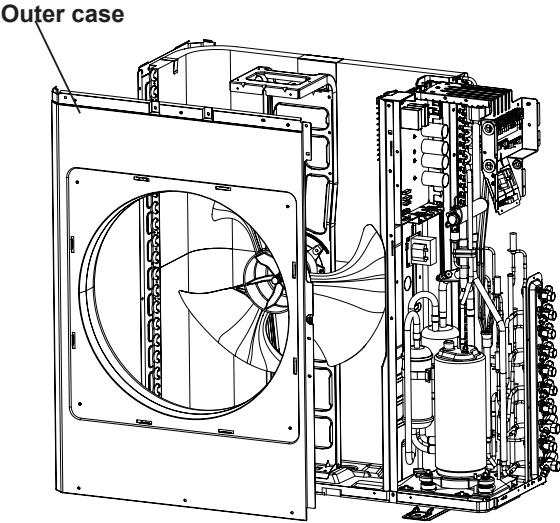
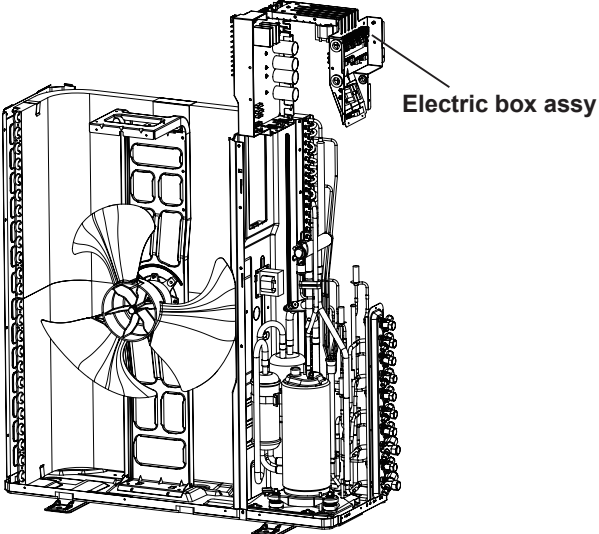
Steps	Procedure
<p>6. Remove grille</p>	<p>Remove the 4 screws connecting the grille and outer case, and then remove the panel grille.</p> 
<p>7. Remove outer case</p>	<p>Remove screws connecting outer case and motor support, middle isolation sheet and chassis, pull the outer case upwards slightly, loosen clasps between outer case and left side plate, and then remove the outer case.</p> 
<p>8. Remove electric box assy</p>	<p>a. Remove the grounding wire screw on the electric box assy and then remove the grounding wire.</p> <p>b. Disconnect the wiring terminals of compressor, high pressure switch, compressor overload protector, temperature sensor, outdoor fan motor and 4-way valve.</p> <p>Note: keep pressing the circlip when disconnecting the wiring terminal of reactor; keep pressing the retainer when disconnecting other wiring terminals.</p> <p>c. Remove the wire inside the wiring groove.</p> 

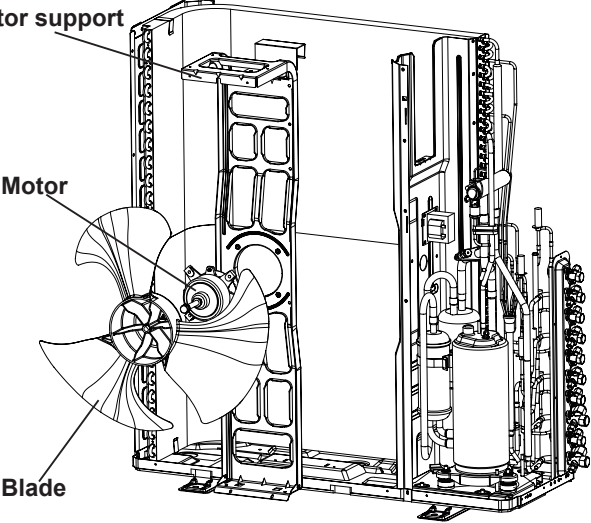
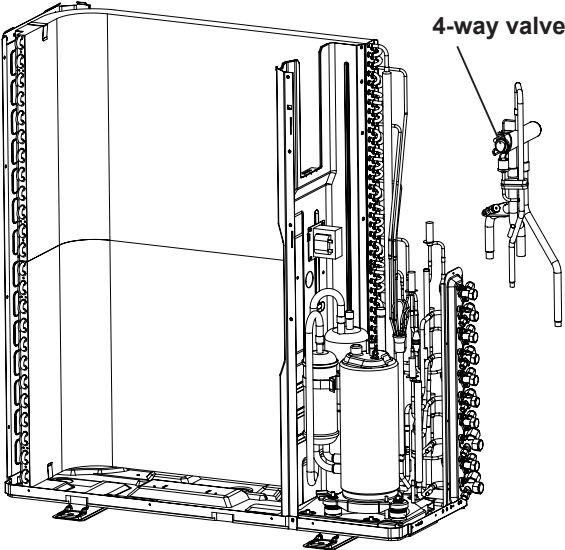
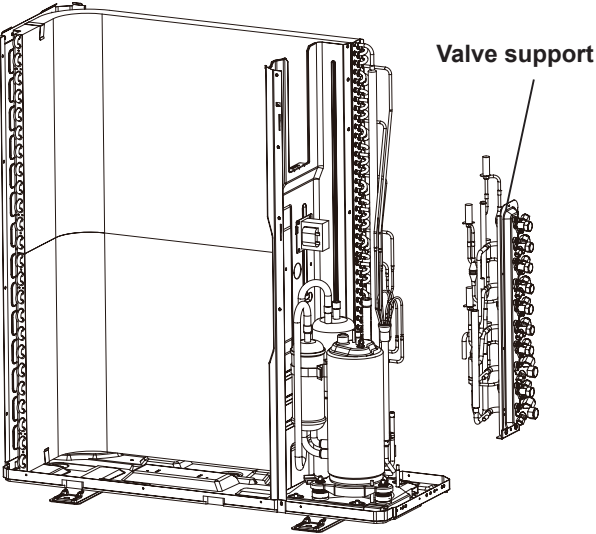
Steps	Procedure
<p>9. Remove blade, motor, motor support</p>	<p>a.Remove nuts fixing axial flow blade with wrench, and then remove the axial flow blade.</p> <p>b.Remove screws connecting motor support and chassis, loosen damper block and then remove the motor support.</p> <p>c.Remove screws fixing motor, and then remove the motor</p> 
<p>10. Remove 4-way valve</p>	<p>Unsolder the spot weld between 4-way valve and vapour liquid separator, compressor cut-off valve sub-assy and condenser, and then remove the 4-way valve.</p> <p>Note: When unsoldering the spot weld, wrap the 4-way valve with wet cloth completely to avoid damage to valve due to high temperature.</p> 
<p>11. Remove valve support</p>	<p>Unsolder all spot welds connected with valve support and then remove the valve support.</p> <p>Note: When unsoldering the spot weld, wrap the gas valve and liquid valve with wet cloth completely to avoid damage to valve due to high temperature.</p> 

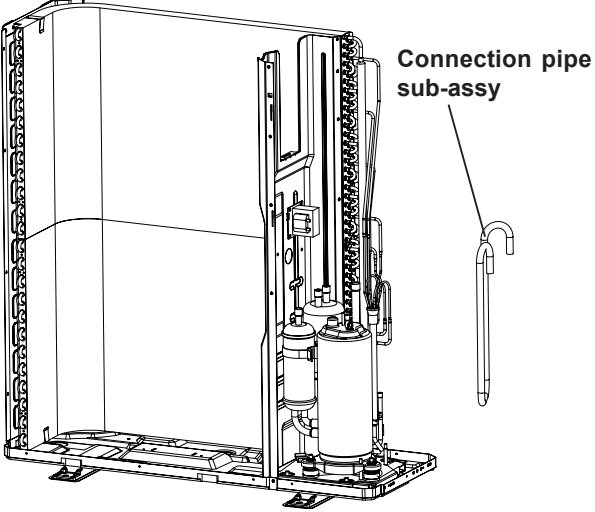
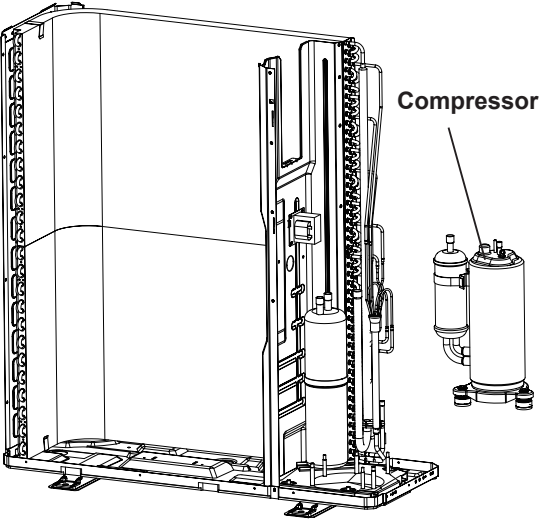
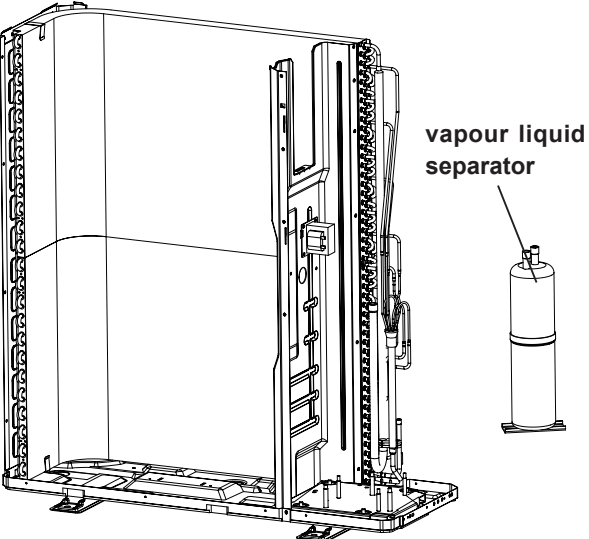
Steps	Procedure
<p>12. Remove connection pipe sub-assy</p>	<p>Remove all spot welds connected with connection pipe, and then remove the connection pipe sub-assy.</p> 
<p>13. Remove compressor</p>	<p>Remove the 3 foot nuts fixing compressor and then lift the compressor upwards to remove the compressor and damping cushion. Note: Keep the ports of discharge pipe and suction pipe from foreign objects.</p> 
<p>14. Remove vapour liquid separator</p>	<p>Unsolder spot welds connected with vapour liquid separator, remove screws connected vapour liquid separator and middle isolation sheet, and then remove the vapour liquid separator.</p> 

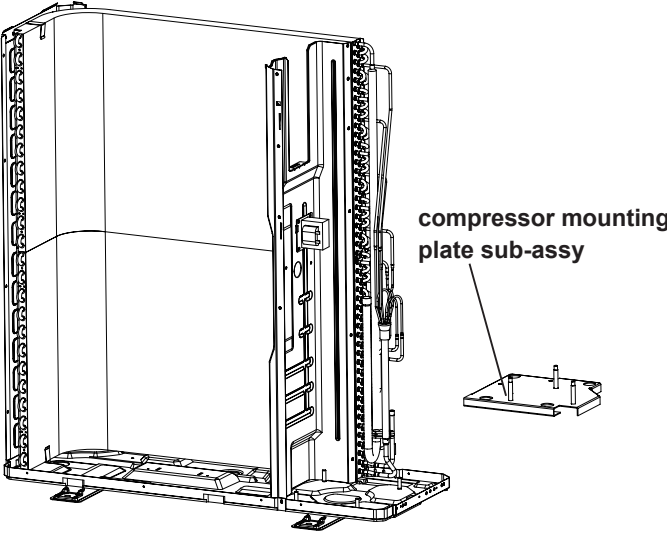
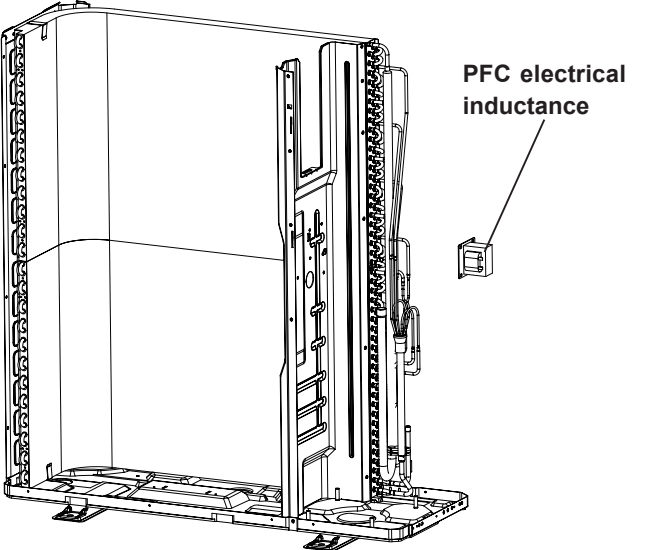
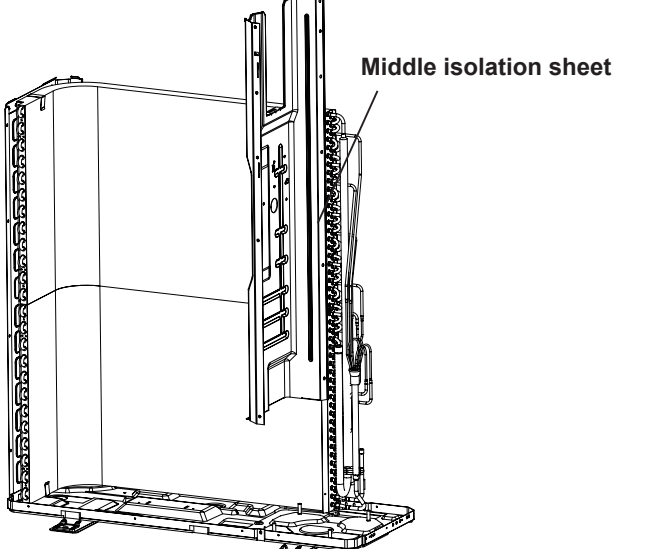
Steps	Procedure
<p>15. Remove compressor mounting plate sub-assy</p>	<p>Remove the 4 foot nuts fixing compressor mounting plate sub-assy and chassis, to remove the compressor mounting plate sub-assy.</p>  <p>compressor mounting plate sub-assy</p>
<p>16. Remove PFC electrical inductance</p>	<p>Remove the screws fixing PFC electrical inductance and isolation sheet, to remove the PFC electrical inductance.</p>  <p>PFC electrical inductance</p>
<p>17. Remove middle isolation sheet</p>	<p>Remove screws connecting middle isolation sheet and support plate of condenser, chassis, and then remove the middle isolation sheet.</p>  <p>Middle isolation sheet</p>

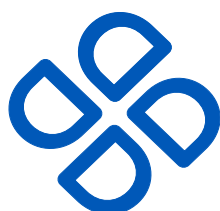

DELTRON[®]

A **BEIJER REF** Company

Split, Vukovarska 148
Tel: +385 (0)21 453 400
Fax: +385 (0)21 473 943
deltron@deltron.hr

Zagreb, Zagrebačka avenija 104
Tel: +385 (0)1 60 64 777
Fax: +385 (0)1 60 64 778
deltron.zagreb@deltron.hr

Sarajevo, Pijačna 14k, 71000
Tel: +387 (0) 33 840 200
Fax: +387 (0) 33 840 203
deltron.sarajevo@deltron.ba

DISTRIBUTOR



www.deltron.hr