



TECHNICAL & SERVICE MANUAL

R410A

[Model Name]	[Service Ref.]	
SUZ-KA25VA6	SUZ-KA25VA6.TH SUZ-KA25VA6.TH-ET	SUZ-KA25VA6.TH-ER
SUZ-KA35VA6	SUZ-KA35VA6.TH SUZ-KA35VA6.TH-ET	SUZ-KA35VA6.TH-ER
SUZ-KA50VA6	SUZ-KA50VA6.TH SUZ-KA50VA6.TH-ET	SUZ-KA50VA6.TH-ER
SUZ-KA60VA6	SUZ-KA60VA6.TH SUZ-KA60VA6.TH-ET	SUZ-KA60VA6.TH-ER
SUZ-KA71VA6	SUZ-KA71VA6.TH SUZ-KA71VA6.TH-ET	SUZ-KA71VA6.TH-ER

Note:

•This service manual describes service data of the outdoor units only.

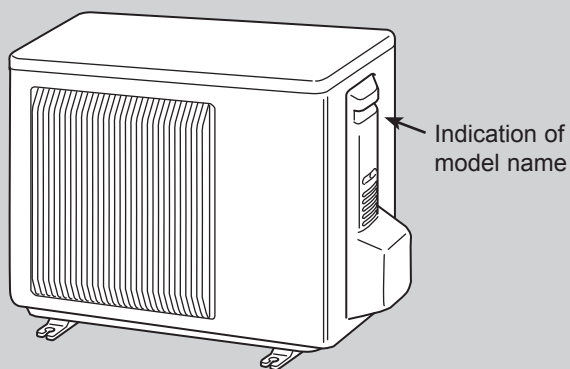

SUZ-KA25VA6.TH
SUZ-KA35VA6.TH

CONTENTS

1. COMBINATION OF INDOOR AND OUTDOOR UNITS	2
2. PARTS NAMES AND FUNCTIONS	3
3. SPECIFICATION	4
4. NOISE CRITERIA CURVES	6
5. OUTLINES AND DIMENSIONS	7
6. WIRING DIAGRAM	9
7. REFRIGERANT SYSTEM DIAGRAM	12
8. ACTUATOR CONTROL	16
9. SERVICE FUNCTIONS	17
10. TROUBLESHOOTING	17
11. DISASSEMBLY PROCEDURE	34

PARTS CATALOG (TCB004)

INDOOR UNIT SERVICE MANUAL

	Indoor unit		Outdoor unit				
			Heat pump type				
			SUZ-				
Service Ref.	Service manual No.	KA25VA6.TH	KA35VA6.TH	KA50VA6.TH	KA60VA6.TH	KA71VA6.TH	
		KA25VA6.TH-ER KA25VA6.TH-ET	KA35VA6.TH-ER KA35VA6.TH-ET	KA50VA6.TH-ER KA50VA6.TH-ET	KA60VA6.TH-ER KA60VA6.TH-ET	KA71VA6.TH-ER KA71VA6.TH-ET	
Heat pump without electric heater	SLZ-KF25VA2.TH(-ER)	OCH616 OCB616	○	—	—	—	—
	SLZ-KF35VA2.TH(-ER)		—	○	—	—	—
	SLZ-KF50VA2.TH(-ER)		—	—	○	—	—
	SLZ-KF60VA2.TH(-ER)		—	—	—	○	—
	SEZ-KD25VAQR2.TH(-ER)	HWE1008 BWE102040 (BWE014090)	○	—	—	—	—
	SEZ-KD35VAQR2.TH(-ER)		—	○	—	—	—
	SEZ-KD50VAQR2.TH(-ER)		—	—	○	—	—
	SEZ-KD60VAQR2.TH(-ER)		—	—	—	○	—
	SEZ-KD71VAQR2.TH(-ER)	HWE0711 BWE012050	—	—	—	—	○
	SEZ-KD25VALR2.TH		○	—	—	—	—
	SEZ-KD35VALR2.TH		—	○	—	—	—
	SEZ-KD50VALR2.TH		—	—	○	—	—
	SEZ-KD60VALR2.TH		—	—	—	○	—
	SEZ-KD71VALR2.TH	—	—	—	—	○	
	PLA-RP35EA.UK	OCH625 OCB625	—	○	—	—	—
	PLA-RP50EA.UK		—	—	○	—	—
	PLA-RP60EA.UK		—	—	—	○	—
	PLA-RP71EA.UK		—	—	—	—	○
	PCA-RP35KAQR2(-ER)	OCH491 OCB491	—	○	—	—	—
	PCA-RP50KAQR2(-ER)		—	—	○	—	—
	PCA-RP60KAQR2(-ER)		—	—	—	○	—
	PCA-RP71KAQR2(-ER)		—	—	—	—	○
	PEAD-RP35JAQR2.UK	BWE014160	—	○	—	—	—
	PEAD-RP50JAQR2.UK		—	—	○	—	—
	PEAD-RP60JAQR2.UK		—	—	—	○	—
	PEAD-RP71JAQR2.UK		—	—	—	—	○
	PEAD-RP35JALQR2.UK		—	○	—	—	—
	PEAD-RP50JALQR2.UK		—	—	○	—	—
PEAD-RP60JALQR2.UK	—		—	—	○	—	
PEAD-RP71JALQR2.UK	—		—	—	—	○	

2

PARTS NAMES AND FUNCTIONS

SUZ-KA25VA6
SUZ-KA35VA6

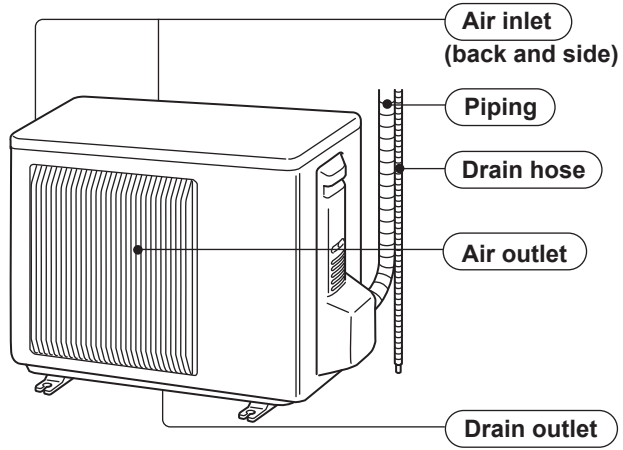

SUZ-KA50VA6
SUZ-KA60VA6
SUZ-KA71VA6

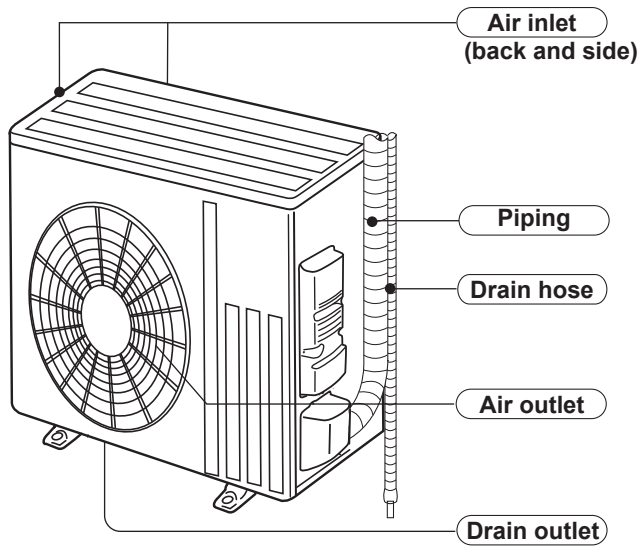

Model	SUZ-KA·VA6
Drain socket	1

3

SPECIFICATION

Outdoor model				SUZ-KA25VA6	SUZ-KA35VA6	SUZ-KA50VA6	SUZ-KA60VA6	SUZ-KA71VA6
Power supply				Single phase 230 V, 50 Hz				
Compressor	Model			KNB073FKFMC	KNB092FFAMC	SNB130FGBMT		SNB172FEKMT
	Output		W	550	650	900		1,200
	Current*	Cooling	A	2.76	4.06	5.58	6.62	8.02
		Heating		3.24	4.09	5.75	6.37	8.13
Refrigeration oil (Model)			L	0.31 (FV50S)	0.27 (FV50S)	0.35 (FV50S)		0.4 (FV50S)
Fan motor	Model			RC0J50-NA		RC0J60-BC	RC0J60-BC	
	Current*	Cooling	A	0.24	0.29	0.84	0.84	0.83
		Heating		0.27	0.28	0.93	0.93	0.82
Dimensions W × H × D			mm	800 × 550 × 285		840 × 880 × 330		
Weight			kg	30	35	54	50	53
Special remarks	Air flow*	Cooling	High	1,806		2,868	3,492	3,426
			Med.	1,806		2,868	3,066	3,006
			Low	1,170	1,038	1,602	1,692	1,512
		Heating	High	2,106		2,778	2,952	2,892
			Med.	1,806	1,770	2,778	2,952	2,892
			Low	1,452	1,326	2,124	2,226	2,280
	Sound pressure level*	Cooling	dB(A)	47	49	52	55	
		Heating		48	50	52	55	
	Sound power level			58	62	65	65	69
	Fan speed	Cooling	High	740	810	840	950	
			Med.	740	810	840		
			Low	740	490	480		450
		Heating	High	860		810		
			Med.	740	770	810		
Low			600	610	620		650	
Fan speed regulator			3					
Refrigerant filling capacity (R410A)			kg	0.80	1.15	1.60	1.60	1.80

Note: Test conditions are based on JIS B8616
 Cooling : Indoor D.B. 27°C W.B. 19°C
 Outdoor D.B. 35°C
 Heating : Indoor D.B. 20°C
 Outdoor D.B. 7°C W.B. 6°C
 Refrigerant piping length (one way): 7 m
 *Measured under rated operating frequency.

Specifications and rating conditions of main electric parts

Item		Model	SUZ-KA25VA6	SUZ-KA35VA6	SUZ-KA50VA6	SUZ-KA60VA6	SUZ-KA71VA6	
Smoothing capacitor	(C61)	—	—	620 μF 420 V	—	—	—	
	(C62, C63)	620 μF 420 V	620 μF 420 V	620 μF 420 V	—	—	—	
	(CB1, 2, 3)	—	—	—	560 μF 450 V	560 μF 350 V	—	
Diode module	(DB61)	15 A 600 V	15 A 600 V	25 A 600 V	—	—	—	
Fuse	(F61)	T20 A L250 V	T20 A L250 V	T20 A L250 V	—	—	—	
	(F62)	—	—	—	T20A L250V	T20A L250V	—	
	(F701, F801, F901)	T3.15 A L250 V	T3.15 A L250 V	T3.15 A L250 V	—	—	—	
	(IC700)	15 A 600 V	15 A 600 V	20 A 600 V	—	—	—	
Intelligent power module	(IPM)	—	—	—	20 A 600 V		—	
	(IC932)	8 A 600 V	8 A 600 V	8 A 600 V	5 A 600 V	5 A 600 V	—	
Power factor controller	(PFC)	—	—	—	20A 600V	20A 600V	—	
	(IC820)	20 A 600 V	20 A 600 V	20 A 600 V	—	—	—	
Expansion valve coil	(LEV)	12 V DC					—	—
Reactor	(L61)	18 mH	23 mH	23 mH	—	—	—	
	(L)	—	—	—	340 μH 20 A	340 μH 20 A	—	
Current-Limiting PTC thermistor	(PTC64, PTC65)	33Ω					—	—
Terminal block	(TB1, TB2)	—	—	—	3P	3P	—	
	(TB)	5P	5P	5P	—	—	—	
Relay	(X63)	3 A 250 V	3 A 250 V	3 A 250 V	—	—	—	
	(X64)	20 A 250 V					—	—
	(X601)	—	—	—	3 A 250 V	3 A 250 V	—	
	(X602)	—	—	—	3 A 250 V	3 A 250 V	—	
R.V. coil	(21S4)	220–240 V AC					—	—

4

NOISE CRITERIA CURVES

SUZ-KA25VA6.TH
SUZ-KA25VA6.TH-ER
SUZ-KA25VA6.TH-ET

FAN SPEED	FUNCTION	SPL(dB(A))	LINE
High Med.	COOLING	47	●—●
	HEATING	48	○—○

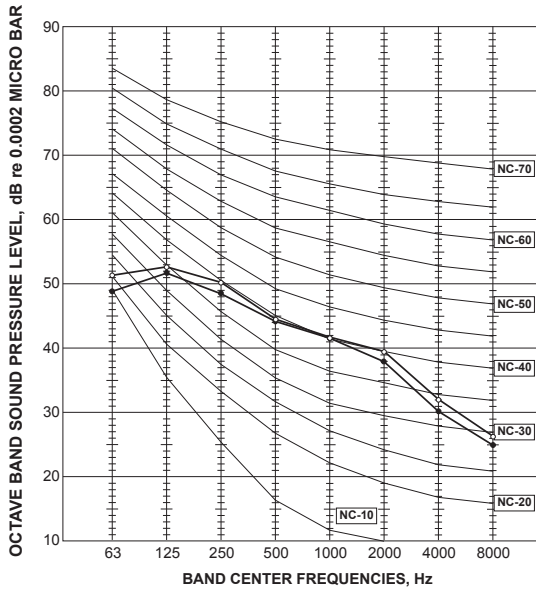

SUZ-KA35VA6.TH
SUZ-KA35VA6.TH-ER
SUZ-KA35VA6.TH-ET

FAN SPEED	FUNCTION	SPL(dB(A))	LINE
High Med.	COOLING	49	●—●
	HEATING	50	○—○

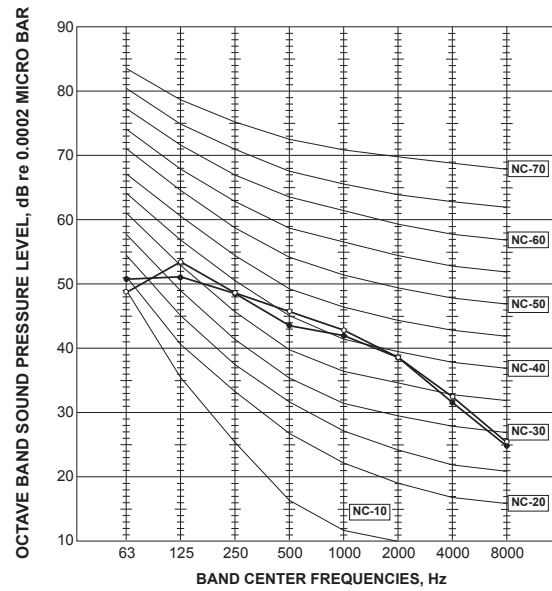

SUZ-KA50VA6.TH
SUZ-KA50VA6.TH-ER
SUZ-KA50VA6.TH-ET

FAN SPEED	FUNCTION	SPL(dB(A))	LINE
High	COOLING	52	●—●
	HEATING	52	○—○

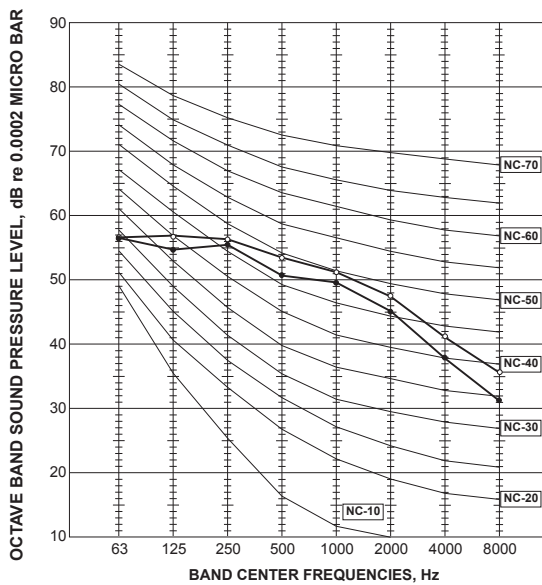

SUZ-KA60VA6.TH **SUZ-KA71VA6.TH**
SUZ-KA60VA6.TH-ER **SUZ-KA71VA6.TH-ER**
SUZ-KA60VA6.TH-ET **SUZ-KA71VA6.TH-ET**

FAN SPEED	FUNCTION	SPL(dB(A))	LINE
High	COOLING	55	●—●
	HEATING	55	○—○

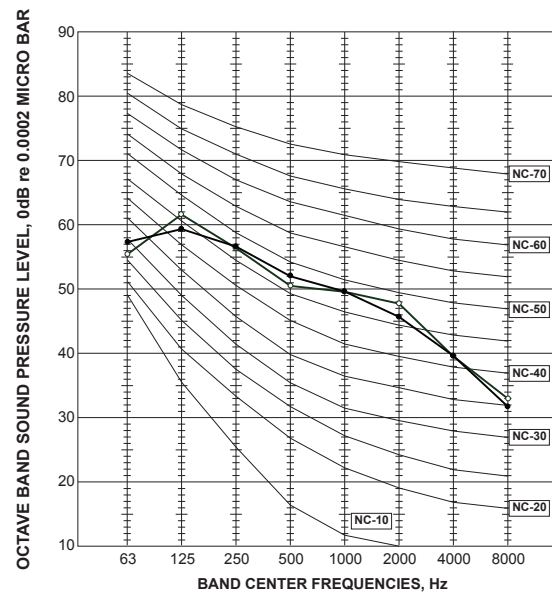

Test conditions

Cooling: Dry-bulb temperature 35°C
 Heating: Dry-bulb temperature 7°C
 Wet-bulb temperature 6°C

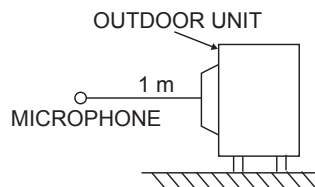

5

OUTLINES AND DIMENSIONS

SUZ-KA25VA6.TH
 SUZ-KA25VA6.TH-ER
 SUZ-KA25VA6.TH-ET

SUZ-KA35VA6.TH
 SUZ-KA35VA6.TH-ER
 SUZ-KA35VA6.TH-ET

Unit: mm

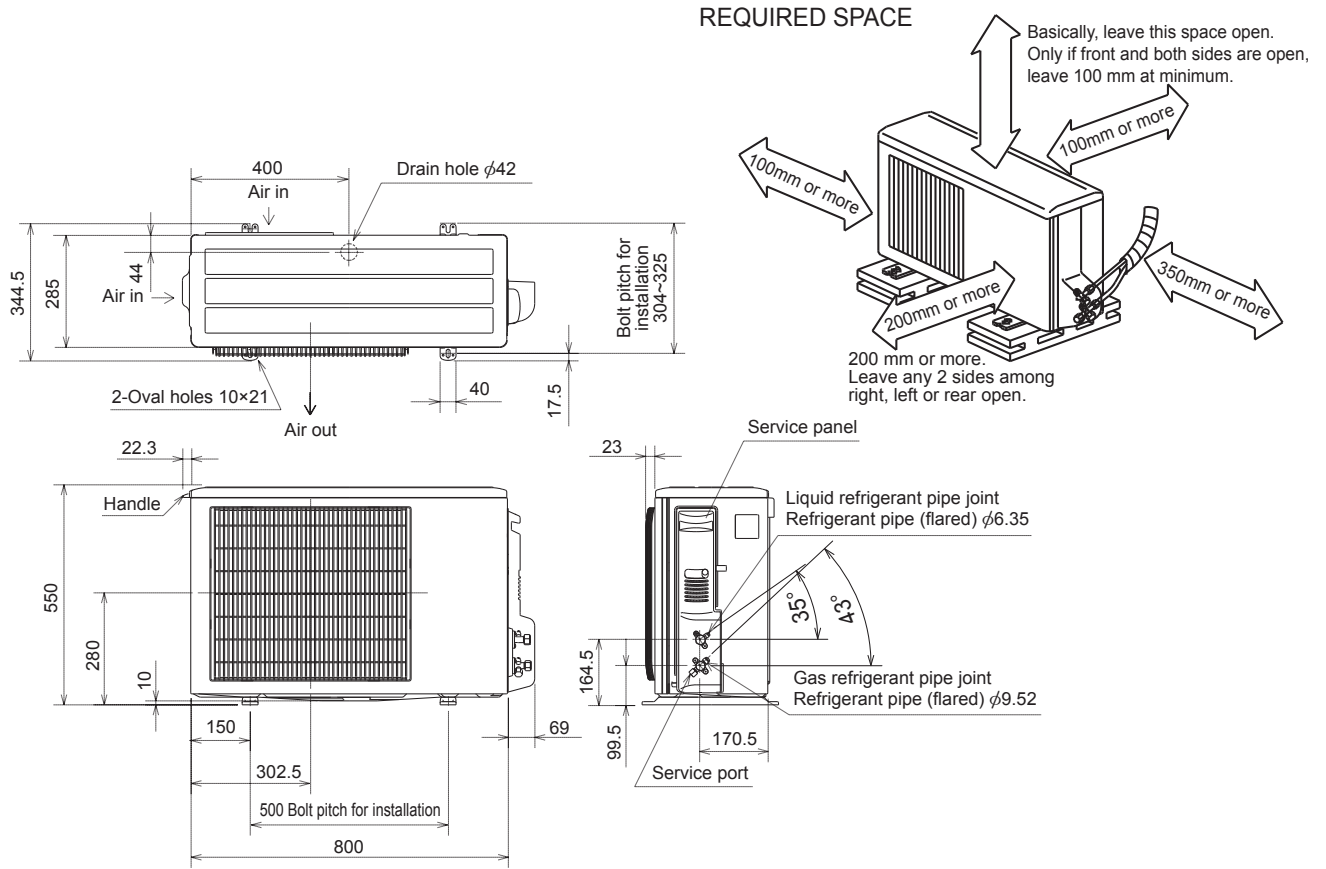

SUZ-KA50VA6.TH
 SUZ-KA50VA6.TH-ER
 SUZ-KA50VA6.TH-ET

SUZ-KA60VA6.TH
 SUZ-KA60VA6.TH-ER
 SUZ-KA60VA6.TH-ET

SUZ-KA71VA6.TH
 SUZ-KA71VA6.TH-ER
 SUZ-KA71VA6.TH-ET

Unit: mm

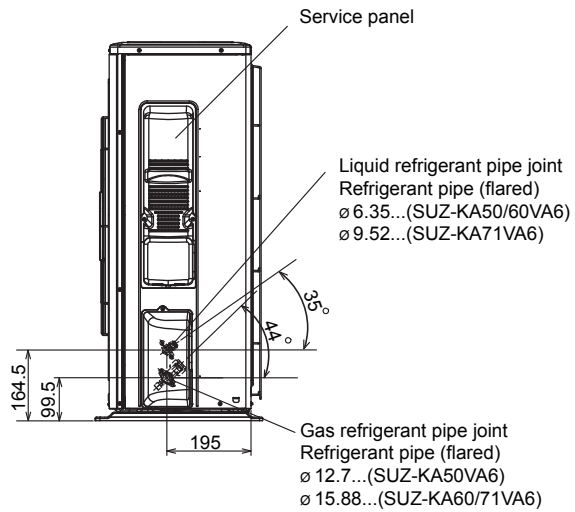
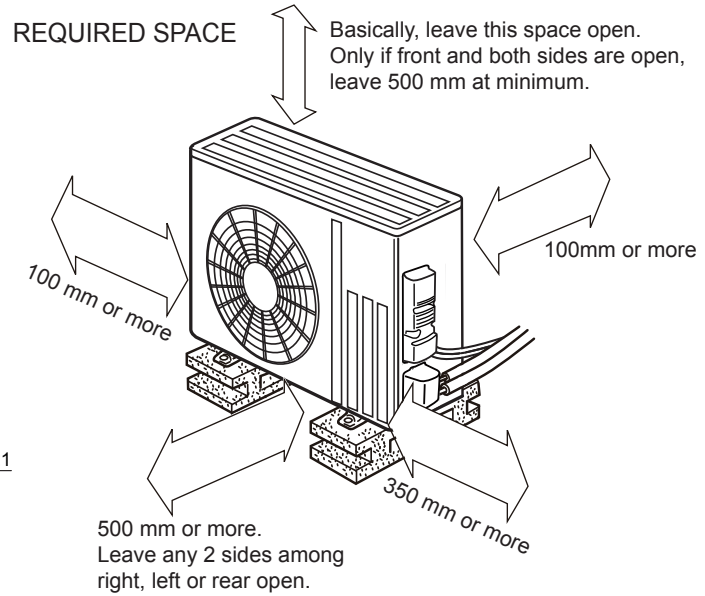
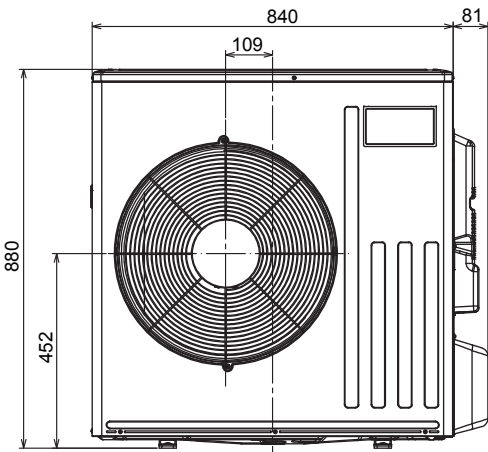
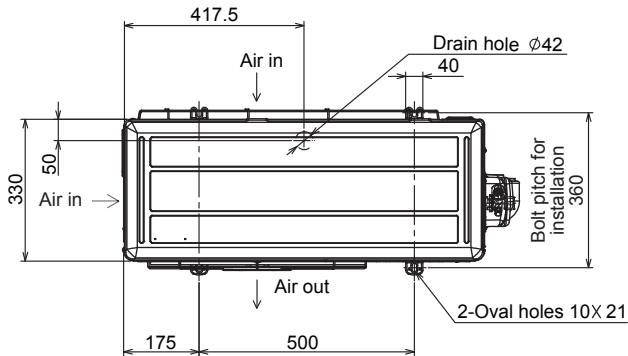

SUZ-KA50VA6.TH
 SUZ-KA50VA6.TH-ER
 SUZ-KA50VA6.TH-ET

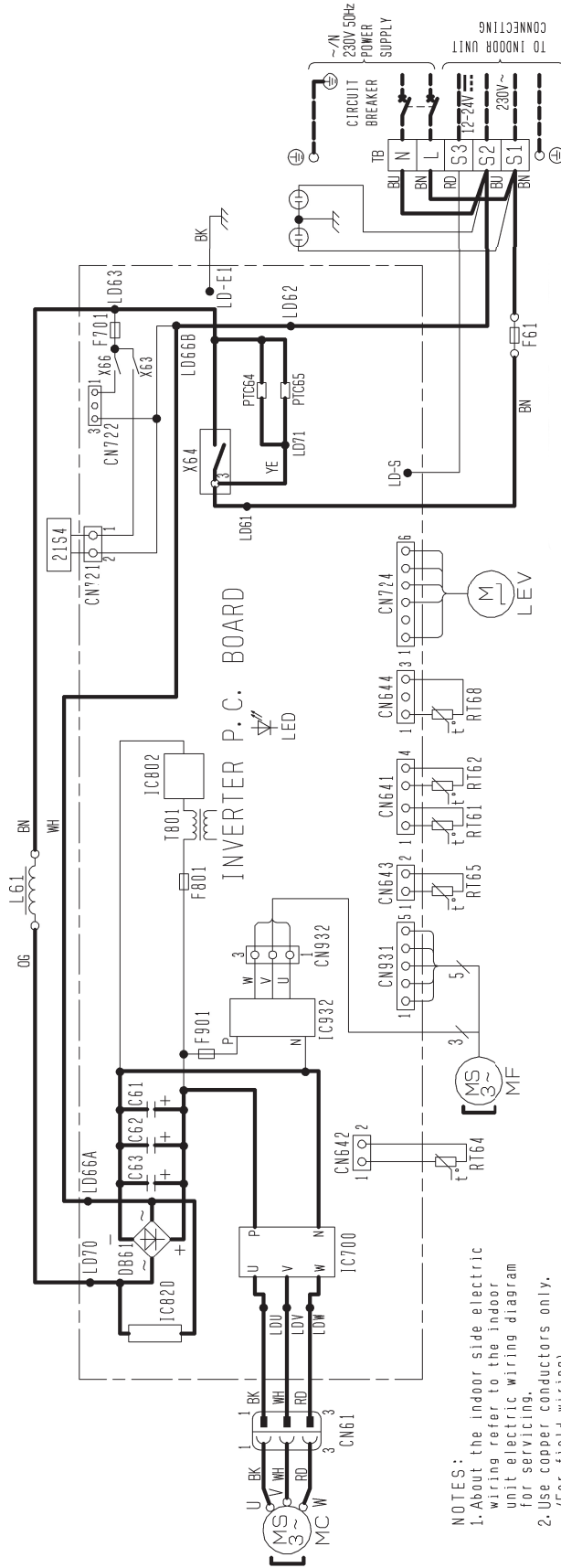

- NOTES:
 1. About the indoor side electric wiring refer to the indoor unit electric wiring diagram for servicing.
 2. Use copper conductors only. (For field wiring).

SYMBOL	NAME	SYMBOL	NAME	SYMBOL	NAME
C61,C62,C63	SMOOTHING CAPACITOR	L61	REACTOR	RT66	OUTDOOR HEAT EXCHANGER TEMP. THERMISTOR.
D661	DIODE MODULE	MC	COMPRESSOR	TB	TERMINAL BLOCK
F61	FUSE (T20AL/250V)	MF	FAN MOTOR	T801	TRANSFORMER
F701,F801,F901	FUSE (T3-15AL/250V)	PTC64, PTC65	CIRCUIT PROTECTION	X63, X64, X66	RELAY
IC700, IC820, IC932	POWER MODULE	RT61	DEFROST THERMISTOR	IC932	REVERSING VALVE COIL
IC802	POWER DEVICE	RT62	DISCHARGE TEMP. THERMISTOR		
LED	LED	RT64	FIN TEMP. THERMISTOR		
LEV	EXPANSION VALVE COIL	RT65	AMBIENT TEMP. THERMISTOR		

SUZ-KA60VA6.TH
 SUZ-KA60VA6.TH-ER
 SUZ-KA60VA6.TH-ET

SUZ-KA71VA6.TH
 SUZ-KA71VA6.TH-ER
 SUZ-KA71VA6.TH-ET

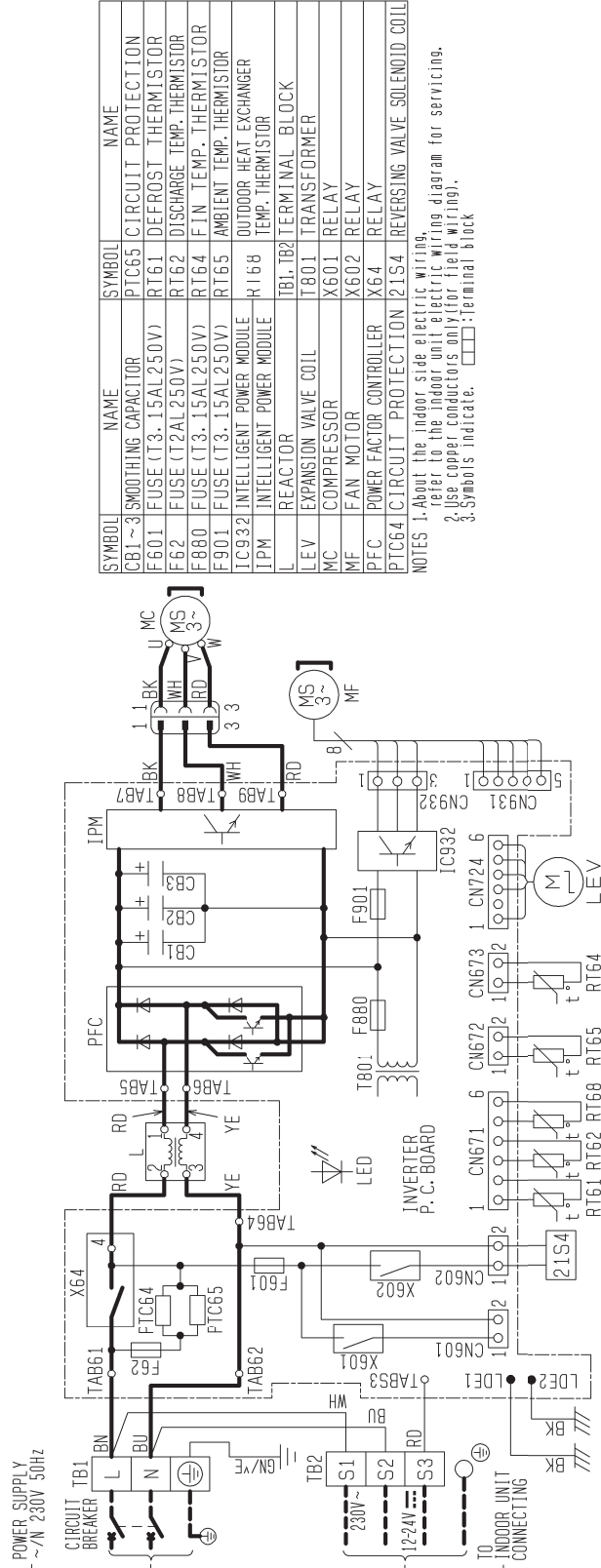

SUZ-KA25VA6.TH
 SUZ-KA25VA6.TH-ER
 SUZ-KA25VA6.TH-ET

Unit: mm

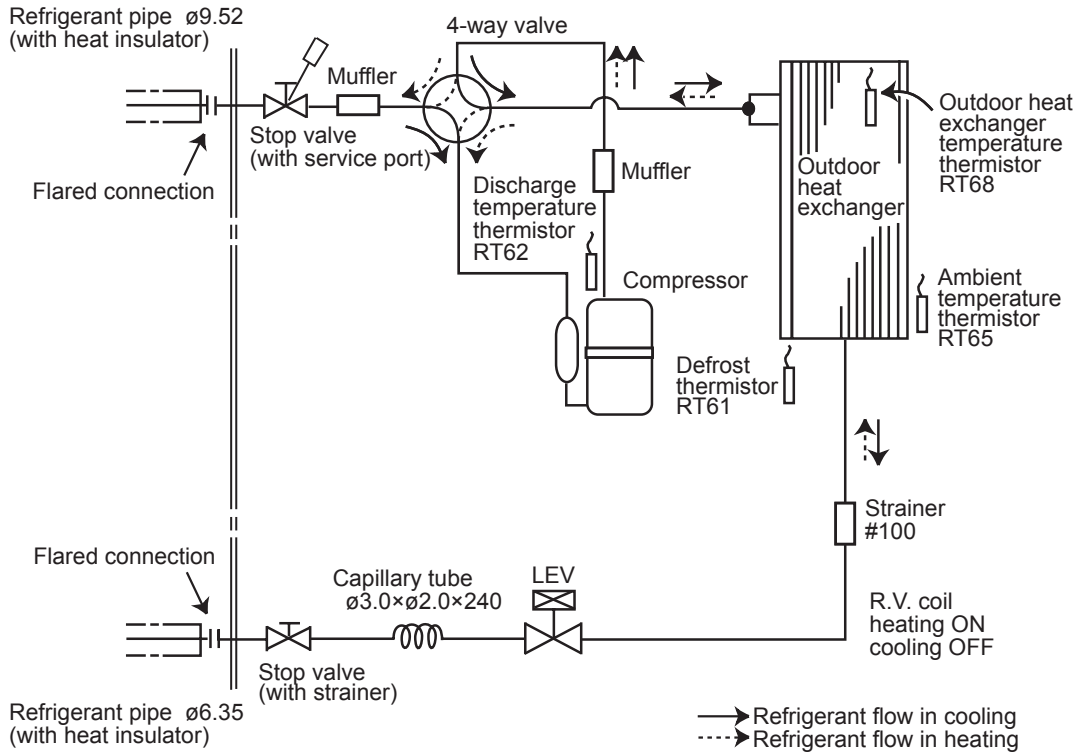

SUZ-KA35VA6.TH
 SUZ-KA35VA6.TH-ER
 SUZ-KA35VA6.TH-ET

Unit: mm

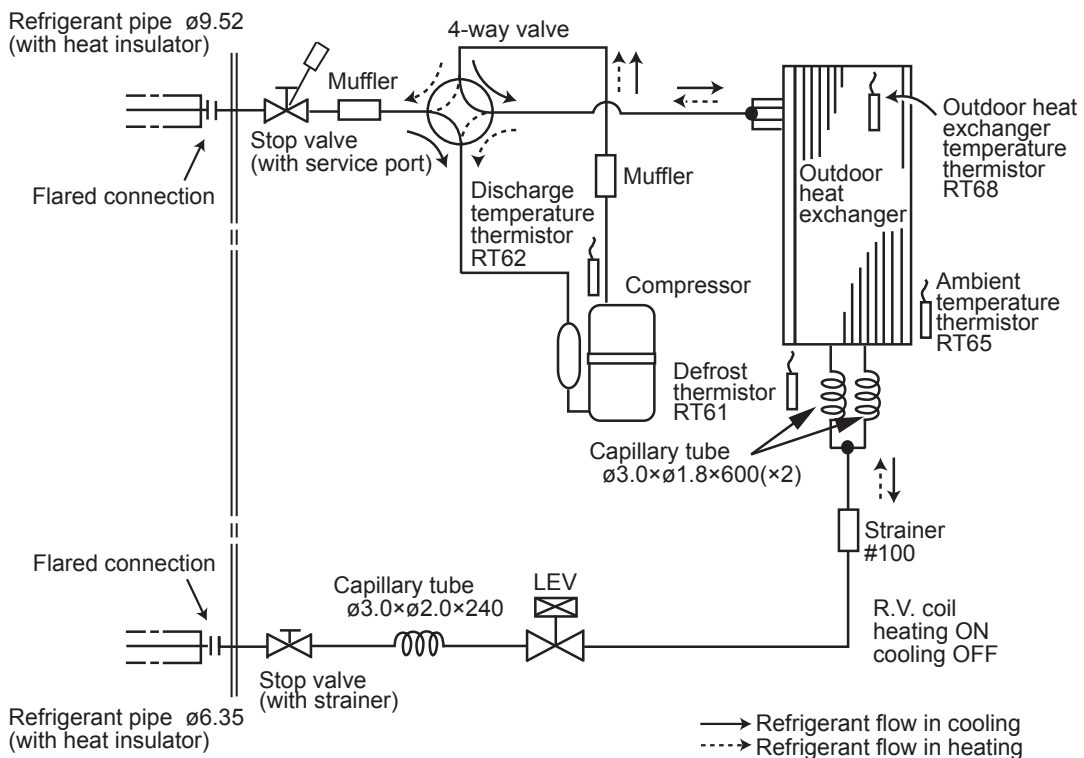

SUZ-KA50VA6.TH
SUZ-KA50VA6.TH-ER
SUZ-KA50VA6.TH-ET

Unit: mm

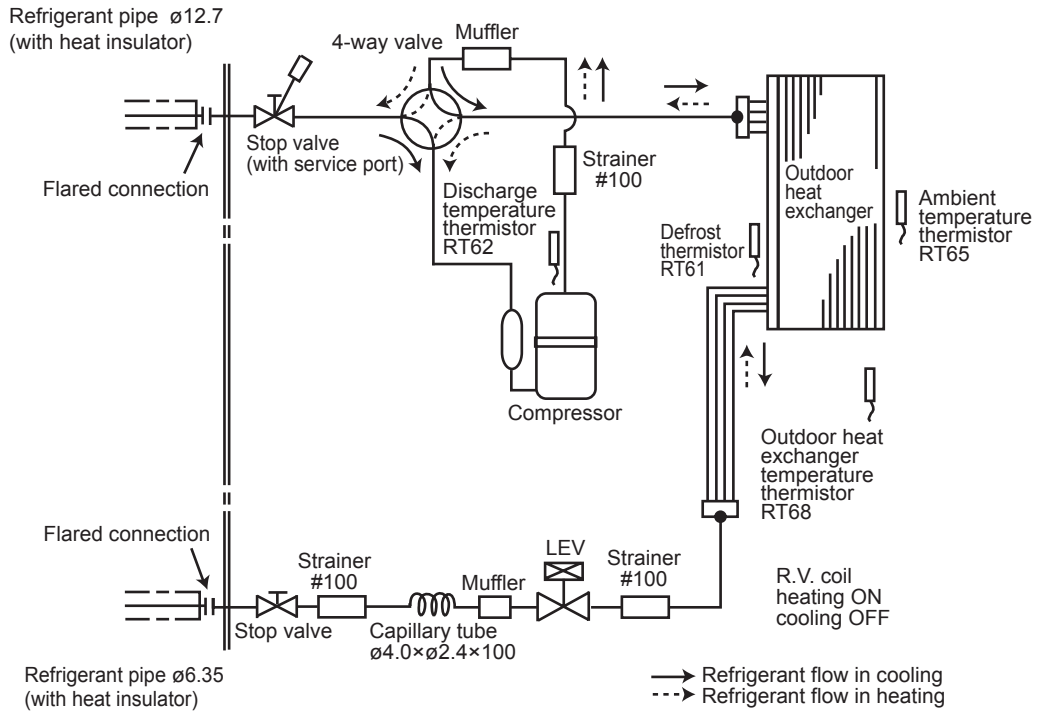

SUZ-KA60VA6.TH
SUZ-KA60VA6.TH-ER
SUZ-KA60VA6.TH-ET

Unit: mm

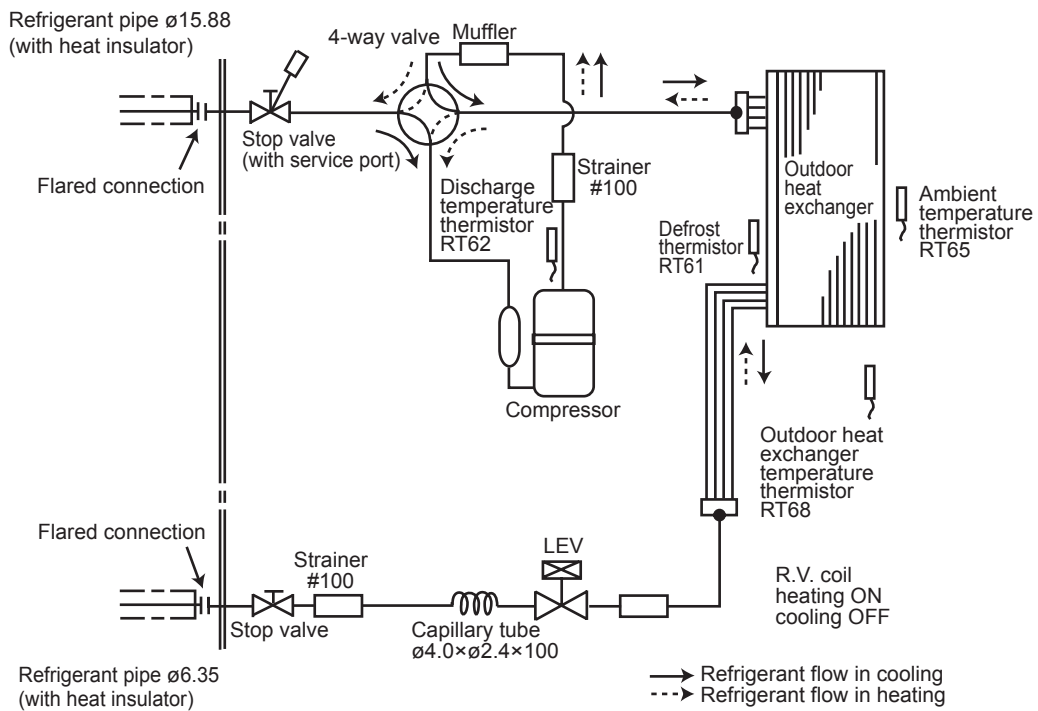

SUZ-KA71VA6.TH
SUZ-KA71VA6.TH-ER
SUZ-KA71VA6.TH-ET

Unit: mm

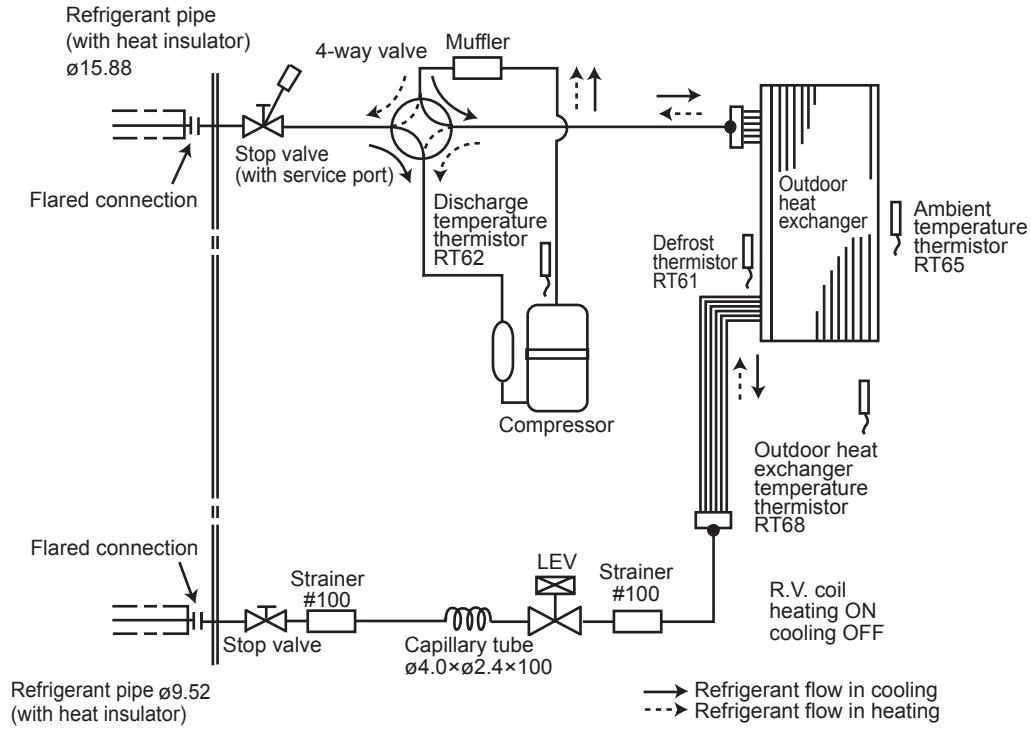

MAX. REFRIGERANT PIPING LENGTH

Model	Refrigerant piping: m		Piping size O.D: mm	
	Max. Length A	Max. Height difference B	Gas	Liquid
SUZ-KA25VA6	20	12	9.52	6.35
SUZ-KA35VA6				
SUZ-KA50VA6	30	30	12.7	
SUZ-KA60VA6			15.88	
SUZ-KA71VA6				9.52

MAX. HEIGHT DIFFERENCE

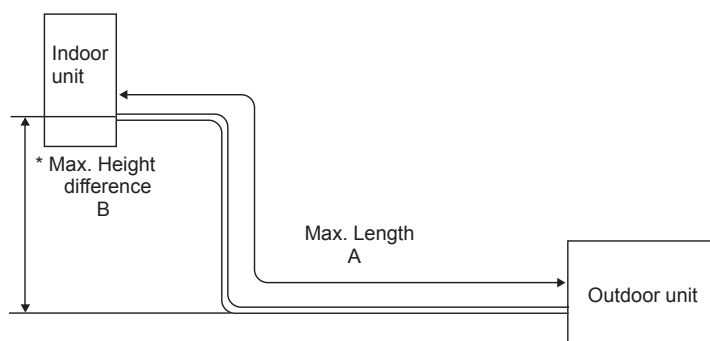

* Height difference limitations are binding regardless of the height position at which either indoor or outdoor is placed higher.

ADDITIONAL REFRIGERANT CHARGE (R410A: g)

Model	Outdoor unit precharged	Refrigerant piping length (one way)									
		7 m	8 m	9 m	10 m	11 m	12 m	13 m	14 m	15 m	20 m
SUZ-KA25VA6	800	0	30	60	90	120	150	180	210	240	390
SUZ-KA35VA6	1,150	0	30	60	90	120	150	180	210	240	390

Calculation: $X_g = 30g/m \times (\text{Refrigerant piping length}(m) - 7)$

Model	Outdoor unit precharged	Refrigerant piping length (one way)					
		7 m	10 m	15 m	20 m	25 m	30 m
SUZ-KA50VA6	1,600	0	60	160	260	360	460
SUZ-KA60VA6	1,600	0	60	160	260	360	460

Calculation : $X_g = 20g/m \times (\text{Refrigerant piping length}(m) - 7)$

Model	Outdoor unit precharged	Refrigerant piping length (one way)					
		7 m	10 m	15 m	20 m	25 m	30 m
SUZ-KA71VA6	1,800	0	165	440	715	990	1,265

Calculation : $X_g = 55g/m \times (\text{Refrigerant piping length}(m) - 7)$

Pumping Down

When relocating or disposing of the air conditioner, pump down the system by following the procedure below so that no refrigerant is released into the atmosphere.

- ① Turn off the power supply (circuit breaker).
- ② Connect the gauge manifold valve to the service port of the stop valve on the gas pipe side of the outdoor unit.
- ③ Fully close the stop valve on the liquid pipe side of the outdoor unit.
- ④ Supply power (circuit breaker).
- ⑤ Perform the refrigerant collecting operation (cooling test run).
 - For the PAR-31MAA, select "Service" → "Test Run" from the main menu to start the test run, and then select the cooling mode.
 - For details or for other information about starting the test run when using remote controllers, refer to the installation manual for the indoor unit or the remote controller.
- ⑥ Fully close the stop valve on the gas pipe side of the outdoor unit when the pressure gauge shows 0.05 to 0 MPa [Gauge] (approx. 0.5 to 0 kgf/cm²) and quickly stop the air conditioner.
 - Push the "ON/OFF" button on the remote controller to stop the air conditioner.

Note:

When the extension piping is very long with a large refrigerant amount, it may not be possible to perform a pump down operation. In this case, use refrigerant recovery equipment to collect all of the refrigerant in the system.

- ⑦ Turn off the power supply (circuit breaker), remove the gauge manifold valve, and then disconnect the refrigerant pipes.

⚠ Warning: When pumping down the refrigerant, stop the compressor before disconnecting the refrigerant pipes.

- If the refrigerant pipes are disconnected while the compressor is operating and the stop valve (ball valve) is open, the pressure in the refrigeration cycle could become extremely high if air is drawn in, causing the pipes to burst, personal injury, etc.

SUZ-KA25VA6.TH
 SUZ-KA25VA6.TH-ER
 SUZ-KA25VA6.TH-ET
 SUZ-KA60VA6.TH
 SUZ-KA60VA6.TH-ER
 SUZ-KA60VA6.TH-ET

SUZ-KA35VA6.TH
 SUZ-KA35VA6.TH-ER
 SUZ-KA35VA6.TH-ET
 SUZ-KA71VA6.TH
 SUZ-KA71VA6.TH-ER
 SUZ-KA71VA6.TH-ET

SUZ-KA50VA6.TH
 SUZ-KA50VA6.TH-ER
 SUZ-KA50VA6.TH-ET

8-1. OUTDOOR FAN MOTOR CONTROL

The fan motor turns ON/OFF, interlocking with the compressor.

[ON] The fan motor turns ON 5 seconds before the compressor starts up.

[OFF] The fan motor turns OFF 15 seconds after the compressor has stopped running.

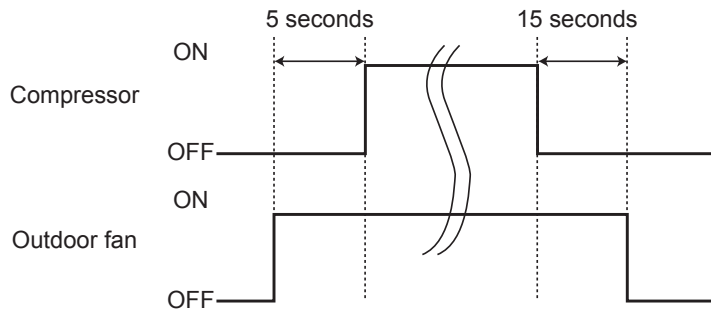

8-2. R.V. COIL CONTROL

Heating ON
 Cooling OFF
 Dry OFF

NOTE: The 4-way valve reverses for 5 seconds right before start-up of the compressor.

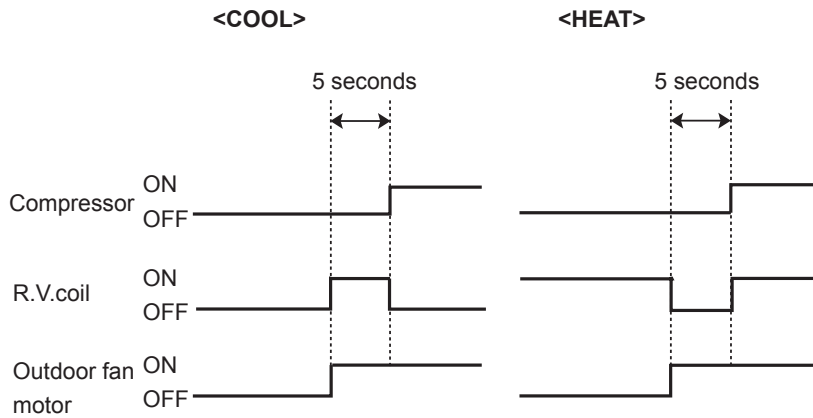

8-3. RELATION BETWEEN MAIN SENSOR AND ACTUATOR

Sensor	Purpose	Actuator				
		Compressor	LEV	Outdoor fan motor	R.V.coil	Indoor fan motor
Discharge temperature thermistor	Protection	○	○			
Indoor coil temperature thermistor	Cooling: Coil frost prevention	○				
	Heating: High pressure protection	○	○			
Defrost thermistor	Heating: Defrosting	○	○	○	○	○
Fin temperature thermistor	Protection	○		○		
Ambient temperature thermistor	Cooling: Low ambient temperature operation	○	○	○		
Outdoor heat exchanger temperature thermistor	Cooling: Low ambient temperature operation	○	○	○		
	Cooling: High pressure protection	○	○	○		

9

SERVICE FUNCTIONS

SUZ-KA25VA6.TH
 SUZ-KA25VA6.TH-ER
 SUZ-KA25VA6.TH-ET
 SUZ-KA60VA6.TH
 SUZ-KA60VA6.TH-ER
 SUZ-KA60VA6.TH-ET

SUZ-KA35VA6.TH
 SUZ-KA35VA6.TH-ER
 SUZ-KA35VA6.TH-ET
 SUZ-KA71VA6.TH
 SUZ-KA71VA6.TH-ER
 SUZ-KA71VA6.TH-ET

SUZ-KA50VA6.TH
 SUZ-KA50VA6.TH-ER
 SUZ-KA50VA6.TH-ET

CHANGE IN DEFROST SETTING

Changing defrost finish temperature

<JS> To change the defrost finish temperature, cut/solder the JS wire of the outdoor inverter P.C. board. (Refer to "10-6-1. Inverter P.C. board".)

Jumper wire		Defrost finish temperature (°C)			
		SUZ-KA25VA6	SUZ-KA35VA6	SUZ-KA50VA6	SUZ-KA60VA6 SUZ-KA71VA6
JS	Soldered (Initial setting)	5	9	9	10
	None (cut)	8	13	18	18

10

TROUBLESHOOTING

SUZ-KA25VA6.TH
 SUZ-KA25VA6.TH-ER
 SUZ-KA25VA6.TH-ET
 SUZ-KA60VA6.TH
 SUZ-KA60VA6.TH-ER
 SUZ-KA60VA6.TH-ET

SUZ-KA35VA6.TH
 SUZ-KA35VA6.TH-ER
 SUZ-KA35VA6.TH-ET
 SUZ-KA71VA6.TH
 SUZ-KA71VA6.TH-ER
 SUZ-KA71VA6.TH-ET

SUZ-KA50VA6.TH
 SUZ-KA50VA6.TH-ER
 SUZ-KA50VA6.TH-ET

10-1. CAUTIONS ON TROUBLESHOOTING

1. Before troubleshooting, check the following items:

- 1) Check the power supply voltage.
- 2) Check the indoor/outdoor connecting wire for miswiring.

2. Take care of the following during servicing.

- 1) Before servicing the air conditioner, be sure to turn OFF the main unit first with the remote controller, and turn off the breaker.
- 2) Be sure to turn OFF the power supply before removing the front panel, the cabinet, the top panel, and the electronic control P.C. board.
- 3) When removing the electrical parts, be careful of the residual voltage of smoothing capacitor.
- 4) When removing the electronic control P.C. board, hold the edge of the board with care NOT to apply stress on the components.
- 5) When connecting or disconnecting the connectors, hold the housing of the connector. DO NOT pull the lead wires.

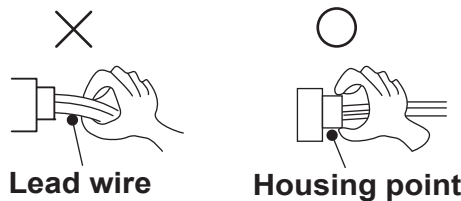

3. Troubleshooting procedure

- 1) Check if the OPERATION INDICATOR lamp on the outdoor P.C. board is blinking on and off to indicate an abnormality. To make sure, check how many times the abnormality indication is blinking on and off before starting service work.
- 2) Before servicing check that the connector and terminal are connected properly.
- 3) If the electronic control P.C. board is supposed to be defective, check the copper foil pattern for disconnection and the components for bursting and discoloration.
- 4) When troubleshooting, refer to "10-2. TROUBLESHOOTING CHECK TABLE" and "10-3. HOW TO PROCEED "SELF-DIAGNOSIS"".

10-2. TROUBLESHOOTING CHECK TABLE

No.	Symptoms	LED indication	check code	Abnormal point/Condition	Condition	Remedy		
1	Outdoor unit does not operate.	1-time flash every 2.5 seconds	UP	Outdoor power system	Overcurrent protection cut-out operates 3 consecutive times within 1 minute after the compressor gets started.	•Reconnect connector of compressor. •Refer to 11-5. Ⓐ "How to check inverter/compressor". •Check stop valve.		
2			U3	Outdoor thermistors	Discharge temperature thermistor shorts, or opens during compressor running. Fin temperature thermistor, defrost thermistor, P.C. board temperature thermistor, outdoor heat exchanger temperature thermistor or ambient temperature thermistor shorts, or opens during compressor running.	•Refer to 11-5. Ⓔ "Check of outdoor thermistors".		
			U4					
3					FC	Outdoor control system	Nonvolatile memory data cannot be read properly.	•Replace inverter P.C. board.
4			6-time flash 2.5 seconds OFF	E8 / E9	Serial signal	The communication fails between the indoor and outdoor unit for 3 minutes.	•Check of indoor/outdoor connecting wire. •Replace indoor or outdoor P.C. board if abnormality is displayed again.	
5			11-time flash 2.5 seconds OFF	UE	Stop valve/ Closed valve	Closed valve is detected by compressor current.	• Check stop valve.	
6	16-time flash 2.5 seconds OFF	PL	Outdoor refrigerant system abnormality	A closed valve and air trapped in the refrigerant circuit are detected based on the temperature sensed by the indoor and outdoor thermistors and the current of the compressor.	• Check for a gas leak in a connecting piping, etc. • Check stop valve. • Refer to 11-5. Ⓣ "Check of outdoor refrigerant circuit".			
7	'Outdoor unit stops and restarts 3 minutes later' is repeated.	2-time flash 2.5 seconds OFF		Overcurrent protection	Large current flows into intelligent power module.	•Reconnect connector of compressor. •Refer to 11-5. Ⓐ "How to check inverter/compressor". •Check stop valve.		
8			3-time flash 2.5 seconds OFF		Discharge temperature overheat protection	Temperature of discharge temperature thermistor exceeds 116°C, compressor stops. Compressor can restart if discharge temperature thermistor reads 100°C or less 3 minutes later.	•Check refrigerant circuit and refrigerant amount. •Refer to 11-5. Ⓛ "Check of LEV".	
9			4-time flash 2.5 seconds OFF		Fin temperature /P.C. board temperature thermistor overheat protection	Temperature of fin temperature thermistor on the heat sink exceeds 72 to 86°C or temperature of P.C. board temperature thermistor on the inverter P.C. board exceeds 72 to 85°C.	•Check around outdoor unit. •Check outdoor unit air passage. •Refer to 11-5. Ⓢ "Check of outdoor fan motor".	
10			5-time flash 2.5 seconds OFF		High pressure protection	Indoor coil thermistor exceeds 70°C in HEAT mode. Defrost thermistor exceeds 70°C in COOL mode.	•Check refrigerant circuit and refrigerant amount. •Check stop valve.	
11			8-time flash 2.5 seconds OFF		Compressor synchronous abnormality	The waveform of compressor current is distorted.	•Reconnect connector of compressor. •Refer to 11-5. Ⓐ "How to check inverter/compressor".	
12			10-time flash 2.5 seconds OFF		Outdoor fan motor	Outdoor fan has stopped 3 times in a row within 30 seconds after outdoor fan start-up.	•Refer to 11-5. Ⓢ "Check of outdoor fan motor". •Refer to 11-5. Ⓣ "Check of inverter P.C. board."	
13			12-time flash 2.5 seconds OFF		Each phase current of compressor	Each phase current of compressor cannot be detected normally.	•Refer to 11-5. Ⓐ "How to check inverter/compressor".	
14			13-time flash 2.5 seconds OFF		DC voltage	DC voltage of inverter cannot be detected normally.	•Refer to 11-5. Ⓐ "How to check inverter/compressor".	
15			Outdoor unit operates.	1-time flash 2.5 seconds OFF		Frequency drop by current protection	When the input current exceeds approximately 7A(KA25)/8A(KA35)/12A(KA50)/14A(KA60)/16A(KA71), compressor frequency lowers.	The unit is normal, but check the following. •Check if indoor filters are clogged. •Check if refrigerant is short. •Check if indoor/outdoor unit air circulation is short cycled.
16					3-time flash 2.5 seconds OFF		Frequency drop by high pressure protection	
		Frequency drop by defrosting in COOL mode				Indoor coil thermistor reads 8°C or less in COOL mode, compressor frequency lowers.		
17	4-time flash 2.5 seconds OFF				Frequency drop by discharge temperature protection	Temperature of discharge temperature thermistor exceeds 111°C, compressor frequency lowers.	•Check refrigerant circuit and refrigerant amount. •Refer to 11-5. Ⓛ "Check of LEV". •Refer to 11-5. Ⓔ "Check of outdoor thermistors".	
18	7-time flash 2.5 seconds OFF				Low discharge temperature protection	Temperature of discharge temperature thermistor has been 50°C or less for 20 minutes.	•Refer to 11-5. Ⓛ "Check of LEV". •Check refrigerant circuit and refrigerant amount.	
19	8-time flash 2.5 seconds OFF		(KA25/35/50) PAM protection PAM: Pulse Amplitude Modulation	The overcurrent flows into PFC (Power factor correction : IC820) or the bus-bar voltage reaches 394 V or more, PAM stops and restarts.	This is not malfunction. PAM protection will be activated in the following cases: 1. Instantaneous power voltage drop. (Short time power failure) 2. When the power supply voltage is high.			
			(KA60/71) Zero cross detecting circuit	Zero cross signal for PAM control cannot be detected.				
20	9-time flash 2.5 seconds OFF		Inverter check mode	The connector of compressor is disconnected, inverter check mode starts.	• Check if the connector of the compressor is correctly connected. • Refer to 11-5. Ⓐ "How to check inverter/compressor".			

Notes: 1. The location of LED is illustrated at the right figure. Refer to "11-6-1. Inverter P.C. board".
2. LED is lighted during normal operation.

The flashing frequency shows the number of times the LED blinks after every 2.5-second OFF.
(Example) When the flashing frequency is "2".

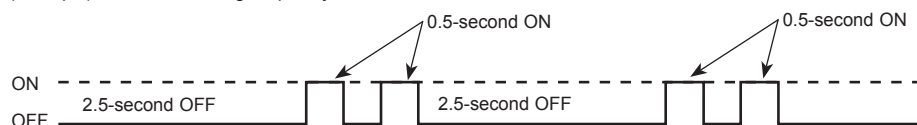

Inverter P.C. board

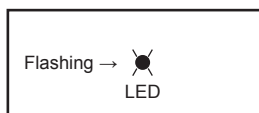

10-3. HOW TO PROCEED "SELF-DIAGNOSIS"

As this air conditioner has a function to memorize all the failures that had occurred, the latest failure detail can be recalled by following the procedure below.

Use this function when the check code is not displayed with wired remote controller or the remote controller at use is wireless type.

10-3-1. Self-diagnosis <PAR-32MAA>

① Select "Service" from the Main menu, and press the  button.



Select "Self check" with the **F1** or **F2** button, and press the  button.

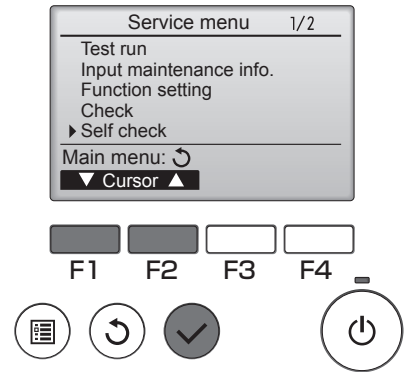

② With the **F1** or **F2** button, enter the refrigerant address, and press the  button.

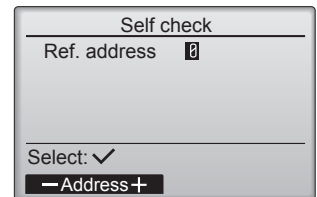

③ Check code, unit number, attribute will appear. "-" will appear if no error history is available.

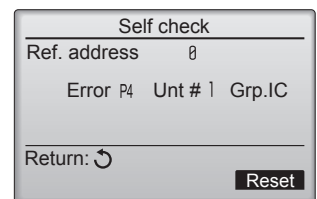

When there is no error history

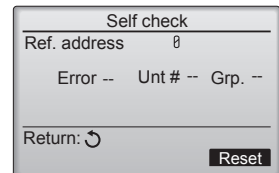

④ Resetting the error history.

Press the **F4** button (Reset) on the screen that shows the error history.



A confirmation screen will appear asking if you want to delete the error history.



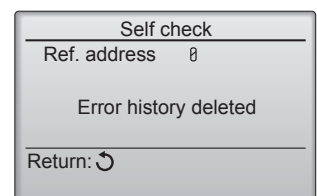
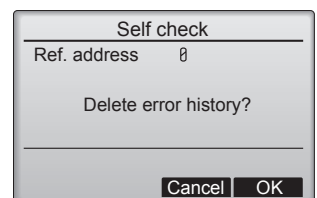

Press the **F4** button (OK) to delete the error history.

If deletion fails, "Request rejected" will appear.
"Unit not exist" will appear if no indoor units that are correspond to the entered address are found.





Navigating through the screens

- To go back to the Service menu  button
- To return to the previous screen  button

10-3-2. Remote controller check <PAR-32MAA>



If operations cannot be completed with the remote controller, diagnose the remote controller with this function.

- ① Select "Service" from the Main menu, and press the  button.

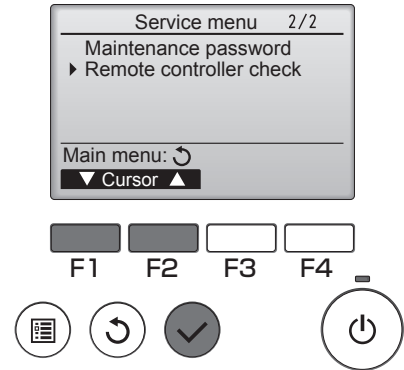
Select "Remote controller check" with the **F1** or **F2** button, and press the  button.



- ② Select "Remote controller check" from the Service menu, and press the  button to start the remote controller check and see the check results.

To cancel the remote controller check and exit the Remote controller check menu screen, press the  or the  button.

The remote controller will not reboot itself.

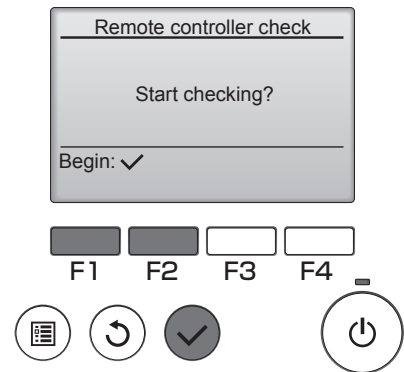

- ③
- OK: No problems are found with the remote controller. Check other parts for problems.
 - E3, 6832: There is noise on the transmission line, or the indoor unit or another remote controller is faulty. Check the transmission line and the other remote controllers.
 - NG (ALL0, ALL1): Send-receive circuit fault. Remote controller needs replacing.
 - ERC: The number of data errors is the discrepancy between the number of bits in the data transmitted from the remote controller and that of the data that was actually transmitted over the transmission line. If data errors are found, check the transmission line for external noise interference.

If the  button is pressed after the remote controller check results are displayed, remote controller check will end, and the remote controller will automatically reboot itself.

Remote controller check results screen

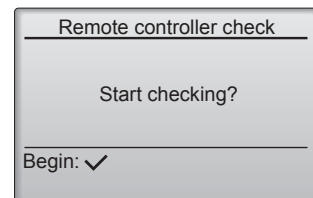



Check the remote controller display and see if anything is displayed (including lines). Nothing will appear on the remote controller display if the correct voltage (8.5–2 V DC) is not supplied to the remote controller. If this is the case, check the remote controller wiring and indoor units.



10-3-3. Self-diagnosis <PAC-YT52CRA>

Retrieve the error history of each unit using the Simple MA controller.

- ① Switch to the self-diagnosis mode.

When the (A)  button and the (C)  button are pressed for 5 seconds or longer, the figure shown below is displayed.

- ② Set the address or refrigerant address No. you want to self-diagnosis.

When the (B)  and (C)  are pressed, the address decreases and increases between 01 and 50 or 00 and 15. Set it to the address No. or refrigerant address No. you want to self-diagnosis.

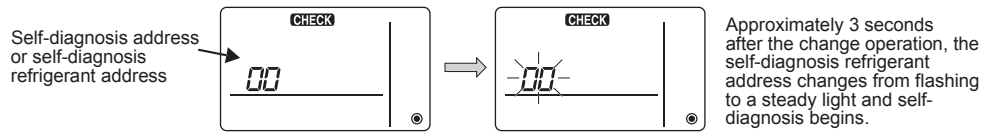

- ③ Self-diagnosis result display <error history>

(For the contents of the check code, refer to the indoor unit installation manual or service handbook.)

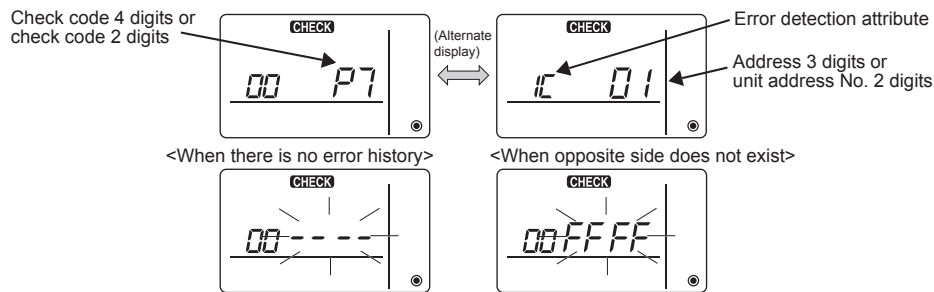

- ④ Error history reset

The error history is displayed in ③ self-diagnosis results display.

When the (D)  button is pressed 2 times successively within 3 seconds, the self-diagnosis object address and refrigerant address flash.

When the error history was reset, the display shown below appears.

When error history reset is failed, the error contents are displayed again.

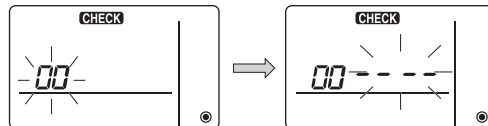

- ⑤ Self-diagnosis reset

There are the following 2 ways of resetting self-diagnosis.

Press the (A)  button and the (C)  button simultaneously for 5 seconds or longer.

→ Resets self-diagnosis and returns to the state before self-diagnosis.

Press the (A)  button. → Self-diagnosis resets and indoor units stop.

(When operation is prohibited, this operation is ineffective.)

10-3-4. Remote Controller Check <PAC-YT52CRA>

When the air conditioner cannot be controlled from the Simple MA controller, use this function to check the remote controller.

- First, check the power mark.
When normal voltage (12 V DC) is not applied to the remote controller, the power mark goes off.
When the power mark is off, check the remote controller wiring and the indoor unit.

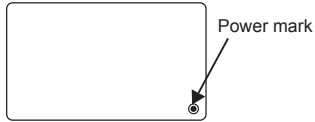

- Switch to the remote controller check mode.
When the **TEMP ▲** button and **CLIMATE** button are pressed simultaneously for 5 seconds or longer, the figure shown below is displayed.
When the **ON/OFF** button is pressed, remote controller check begins.

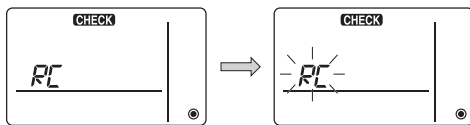

- Remote controller check result
<When remote controller is normal>

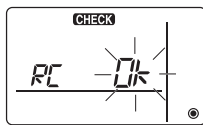

Since there is no problem at the remote controller, check for other causes.
(Error display 1) "NG" flashes → Remote controller sends/receives circuit abnormal

<When remote controller is faulty>

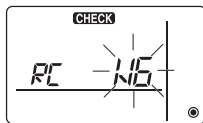

Remote controller switching is necessary.

When the problem is other than the checked remote controller



(Error display 2) "E3" "6833" "6832" flash → Cannot send

There is noise on the transmission line, or the indoor unit or another remote controller is faulty. Check the transmission line and the other remote controllers.



(Error display 3) "ERC" and data error count are displayed → Data error generation

"Data error count" is the difference between the number of bits of remote controller send data and the number of bits actually sent to the transmission line. In this case, the send data was disturbed by the noise, etc. Check the transmission line.

When data error count is 02

Remote controller send data
Send data on transmission line

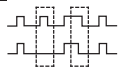

- Remote controller check reset
When the **TEMP ▲** button and **CLIMATE** button are pressed simultaneously for 5 seconds or longer, remote controller diagnosis is reset, the [HO] and run lamp flash for a certain period of time, and then the remote controller returns to its state before diagnosis.

10-3-5. Self-diagnosis <Wireless remote controller>
<In case of trouble during operation, except for SLZ model*>



*For SLZ model, refer to the indoor unit's service manual.

When a malfunction occurs to air conditioner, both indoor unit and outdoor unit will stop and operation lamp blinks to inform unusual stop.

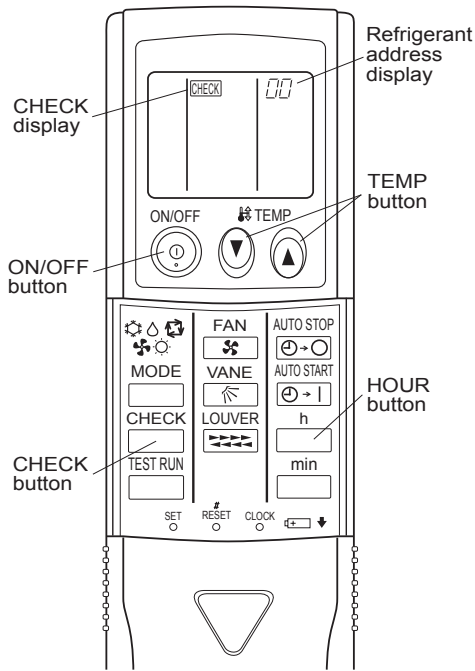
<Malfunction-diagnosis method at maintenance service>



[Procedure]

1. Press the CHECK button twice.
 - "CHECK" lights, and refrigerant address "00" flashes.
 - Check that the remote controller's display has stopped before continuing.
2. Press the TEMP   buttons.
 - Select the refrigerant address of the indoor unit for the self-diagnosis.
 - Note: Set refrigerant address using the outdoor unit's DIP switch (SW1). (For more information, see the outdoor unit installation manual.)
3. Point the remote controller at the sensor on the indoor unit and press the HOUR button.
 - If an air conditioner error occurs, the indoor unit's sensor emits an intermittent buzzer sound, the operation light flashes, and the check code is output. (It takes 3 seconds at most for check code to appear.)
4. Point the remote controller at the sensor on the indoor unit and press the ON/OFF button.
 - The check mode is cancelled.

• Refer to the following tables for details on the check codes.

[Output pattern A]

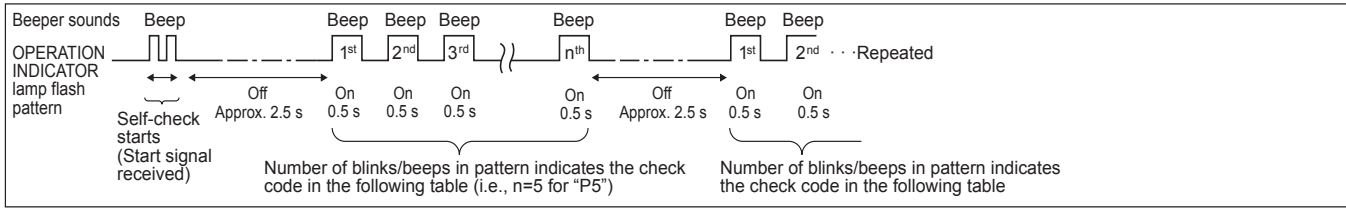

[Output pattern B]

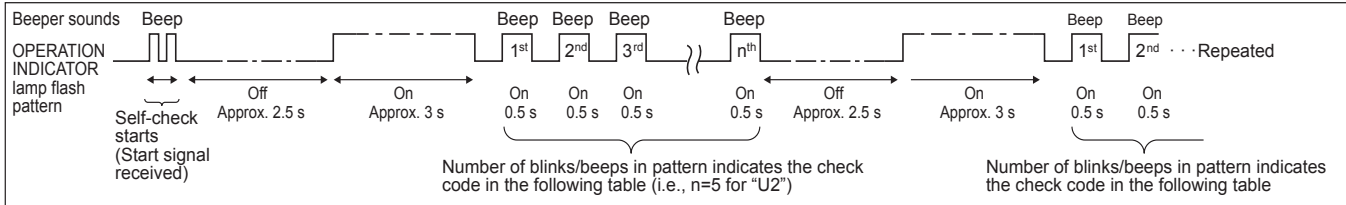

[Output pattern A] Errors detected by indoor unit

Wireless remote controller	Wired remote controller	Symptom	Remark
Beeper sounds/OPERATION INDICATOR lamp flashes (Number of times)	Check code		
1	P1	Intake sensor error	As for indoor unit, refer to indoor unit's service manual.
2	P2	Pipe (TH2) sensor error	
	P9	Pipe (TH5) sensor error	
3	E6, E7	Indoor/outdoor unit communication error	
4	P4	Drain sensor error/Float switch connector (CN4F) open	
5	P5	Drain pump error	
	PA	Forced compressor stop (due to water leakage abnormality)	
6	P6	Freezing/Overheating protection operation	
7	EE	Communication error between indoor and outdoor units	
9	E4, E5	Remote controller signal receiving error	
12	Fb (FB)*	Indoor unit control system error (memory error, etc.)	
14	PL	Abnormality of refrigerant circuit	
–	E0, E3	Remote controller transmission error	
–	E1, E2	Remote controller control board error	

[Output pattern B] Errors detected by unit other than indoor unit (outdoor unit, etc.)

Wireless remote controller	Wired remote controller	Symptom
Beeper sounds/OPERATION INDICATOR lamp flashes (Number of times)	Check code	
1	E9	Indoor/outdoor unit communication error (Transmitting error) (Outdoor unit)
2	UP	Compressor overcurrent interruption
3	U3, U4	Open/short of outdoor unit thermistors
14	PL or others	Abnormality of refrigerant circuit or other errors (Refer to the technical manual for the outdoor unit.)

- Notes: 1. If the beeper does not sound again after the initial 2 beeps to confirm the self-check start signal was received and the OPERATION INDICATOR lamp does not come on, there are no error records.
 2. If the beeper sounds 3 times continuously "beep, beep, beep (0.4 + 0.4 + 0.4 seconds)" after the initial 2 beeps to confirm the self-check start signal was received, the specified refrigerant address is incorrect.

*The check code in the parenthesis indicates PAR-32MAA model.

10-4. TROUBLE CRITERION OF MAIN PARTS

SUZ-KA25VA6.TH

SUZ-KA35VA6.TH

SUZ-KA50VA6.TH

SUZ-KA25VA6.TH-ER

SUZ-KA35VA6.TH-ER

SUZ-KA50VA6.TH-ER

SUZ-KA25VA6.TH-ET

SUZ-KA35VA6.TH-ET

SUZ-KA50VA6.TH-ET

SUZ-KA60VA6.TH

SUZ-KA71VA6.TH

SUZ-KA60VA6.TH-ER

SUZ-KA71VA6.TH-ER

SUZ-KA60VA6.TH-ET

SUZ-KA71VA6.TH-ET

Parts name	Check method and criterion	Figure																									
Defrost thermistor (RT61) Fin temperature thermistor (RT64) Ambient temperature thermistor (RT65) Outdoor heat exchanger temperature thermistor(RT68)	Measure the resistance with a tester. Refer to "10-6. Test point diagram and voltage", 10-6-1. (KA25/35/50) or 10-6-2. (KA60/71) "Inverter P.C. board", for the chart of thermistor.																										
Discharge temperature thermistor (RT62)	Measure the resistance with a tester. Before measurement, hold the thermistor with your hands to warm it up. Refer to "10-6. Test point diagram and voltage", 10-6-1. (KA25/35/50) or 10-6-2. (KA60/71) "Inverter P.C. board", for the chart of thermistor.																										
Compressor	Measure the resistance between terminals with a tester. (Temperature: -10 to 40°C) <table border="1"> <thead> <tr> <th></th> <th colspan="4">Normal</th> </tr> <tr> <th></th> <th>SUZ-KA25VA6</th> <th>SUZ-KA35VA6</th> <th>SUZ-KA50/60VA6</th> <th>SUZ-KA71VA6</th> </tr> </thead> <tbody> <tr> <td>U-V</td> <td></td> <td></td> <td></td> <td></td> </tr> <tr> <td>U-W</td> <td>2.25 to 3.20 Ω</td> <td>1.52 to 2.17 Ω</td> <td>0.78 to 1.11 Ω</td> <td>0.92 to 1.12 Ω</td> </tr> <tr> <td>V-W</td> <td></td> <td></td> <td></td> <td></td> </tr> </tbody> </table>		Normal					SUZ-KA25VA6	SUZ-KA35VA6	SUZ-KA50/60VA6	SUZ-KA71VA6	U-V					U-W	2.25 to 3.20 Ω	1.52 to 2.17 Ω	0.78 to 1.11 Ω	0.92 to 1.12 Ω	V-W					
	Normal																										
	SUZ-KA25VA6	SUZ-KA35VA6	SUZ-KA50/60VA6	SUZ-KA71VA6																							
U-V																											
U-W	2.25 to 3.20 Ω	1.52 to 2.17 Ω	0.78 to 1.11 Ω	0.92 to 1.12 Ω																							
V-W																											
Outdoor fan motor	Measure the resistance between terminals with a tester. (Temperature: -10 to 40°C) <table border="1"> <thead> <tr> <th rowspan="2">Color of the lead wire</th> <th colspan="2">Normal</th> </tr> <tr> <th>SUZ-KA25/35VA6</th> <th>SUZ-KA50/60/71VA6</th> </tr> </thead> <tbody> <tr> <td>WHT - BLK</td> <td rowspan="3">29 to 42 Ω</td> <td rowspan="3">12 to 17 Ω</td> </tr> <tr> <td>BLK - RED</td> </tr> <tr> <td>RED - WHT</td> </tr> </tbody> </table>	Color of the lead wire	Normal		SUZ-KA25/35VA6	SUZ-KA50/60/71VA6	WHT - BLK	29 to 42 Ω	12 to 17 Ω	BLK - RED	RED - WHT																
Color of the lead wire	Normal																										
	SUZ-KA25/35VA6	SUZ-KA50/60/71VA6																									
WHT - BLK	29 to 42 Ω	12 to 17 Ω																									
BLK - RED																											
RED - WHT																											
R.V. coil (21S4)	Measure the resistance between terminals with a tester. (Temperature : -10 to 40°C) <table border="1"> <thead> <tr> <th>Normal</th> </tr> </thead> <tbody> <tr> <td>1.19 to 1.78 kΩ</td> </tr> </tbody> </table>	Normal	1.19 to 1.78 kΩ																								
Normal																											
1.19 to 1.78 kΩ																											
Expansion valve coil (LEV)	Measure the resistance with a tester. (Temperature : -10 to 40°C) SUZ-KA25/35VA6 <table border="1"> <thead> <tr> <th>Color of the lead wire</th> <th>Normal</th> </tr> </thead> <tbody> <tr> <td>WHT - RED</td> <td rowspan="4">37 to 54 Ω</td> </tr> <tr> <td>RED - ORN</td> </tr> <tr> <td>YLW - BRN</td> </tr> <tr> <td>BRN - BLU</td> </tr> </tbody> </table>	Color of the lead wire	Normal	WHT - RED	37 to 54 Ω	RED - ORN	YLW - BRN	BRN - BLU																			
	Color of the lead wire	Normal																									
WHT - RED	37 to 54 Ω																										
RED - ORN																											
YLW - BRN																											
BRN - BLU																											
Measure the resistance with a tester. (Temperature : -10 to 40°C) SUZ-KA50/60/71VA6 <table border="1"> <thead> <tr> <th>Color of the lead wire</th> <th>Normal</th> </tr> </thead> <tbody> <tr> <td>RED - ORN</td> <td rowspan="4">37 to 54 Ω</td> </tr> <tr> <td>RED - WHT</td> </tr> <tr> <td>RED - BLU</td> </tr> <tr> <td>RED - YLW</td> </tr> </tbody> </table>	Color of the lead wire	Normal	RED - ORN	37 to 54 Ω	RED - WHT	RED - BLU	RED - YLW																				
Color of the lead wire	Normal																										
RED - ORN	37 to 54 Ω																										
RED - WHT																											
RED - BLU																											
RED - YLW																											

10-5. TROUBLESHOOTING FLOW

A How to check inverter/compressor

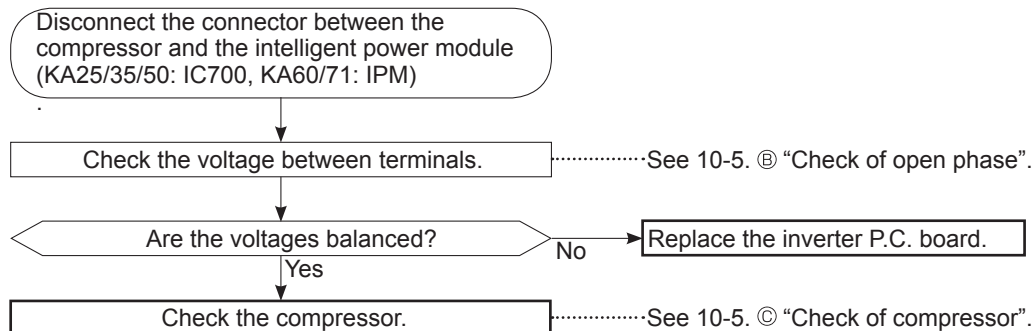

B Check of open phase

- With the connector between the compressor and the intelligent power module disconnected, activate the inverter and check if the inverter is normal by measuring **the voltage balance** between the terminals.

Output voltage is 50–130 V. (The voltage may differ according to the tester.)

<< Operation method (Test run operation)>>

- For the PAR-31MAA, select "Service" → "Test Run" from the main menu to start the test run, and then select the cooling mode.
- For details or for other information about starting the test run when using remote controllers, refer to the installation manual for the indoor unit or the remote controller.

<<Measurement point>>

At 3 points

BLK (U) - WHT (V)

BLK (U) - RED (W)

WHT (V) - RED (W)

Measure AC voltage between the lead wires at 3 points.

NOTE: 1. Output voltage varies according to power supply voltage.

2. Measure the voltage by analog type tester.

3. During this check, LED of the inverter P.C. board flashes 9 times. (KA25/35/50: Refer to 10-6-1, KA60/71: 10-6-2)

C Check of compressor

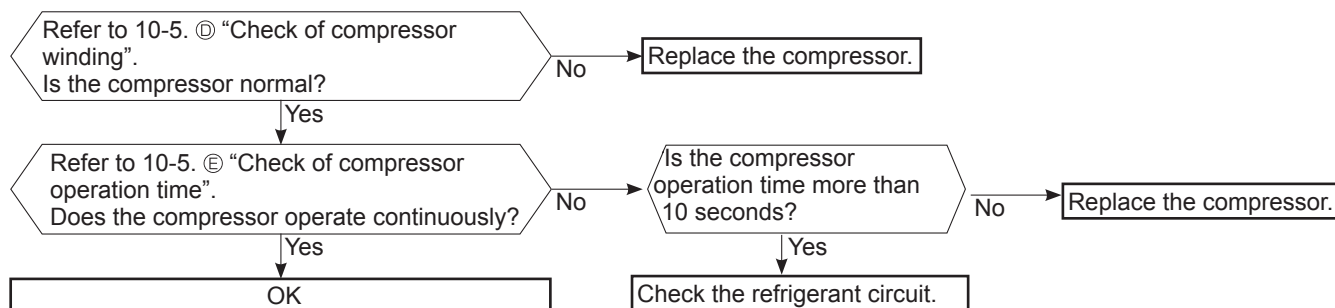

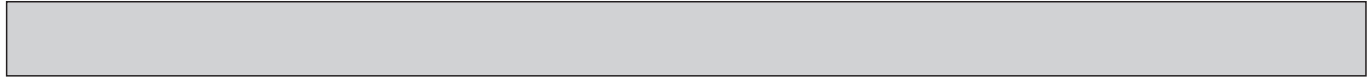

D Check of compressor winding

- Disconnect the connector between the compressor and the intelligent power module, and measure the resistance between the compressor terminals.
- <<Measurement point>>
at 3 points
BLK-WHT
BLK-RED Measure the resistance between the lead wires at 3 points.
WHT-RED
- <<Judgement>>
Refer to "10-4. TROUBLE CRITERION OF MAIN PARTS".
0 [Ω] Abnormal [short]
Infinite [Ω] Abnormal [open]
NOTE: Be sure to zero the ohmmeter before measurement.

E Check of compressor operation time

- Connect the compressor and activate the inverter. Then measure the time until the inverter stops due to overcurrent.
- <<Operation method>>
Start heating or cooling test run.
(TEST RUN OPERATION : Refer to 10-5 ③.)
- <<Measurement>>
Measure the time from the start of compressor to the stop of compressor due to overcurrent.

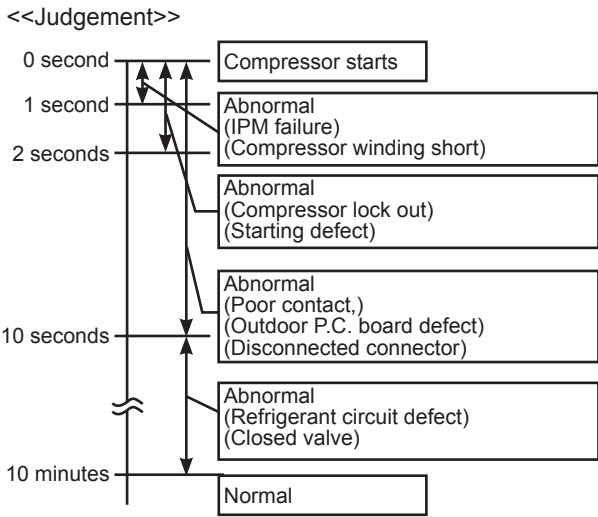

F Check of outdoor thermistors

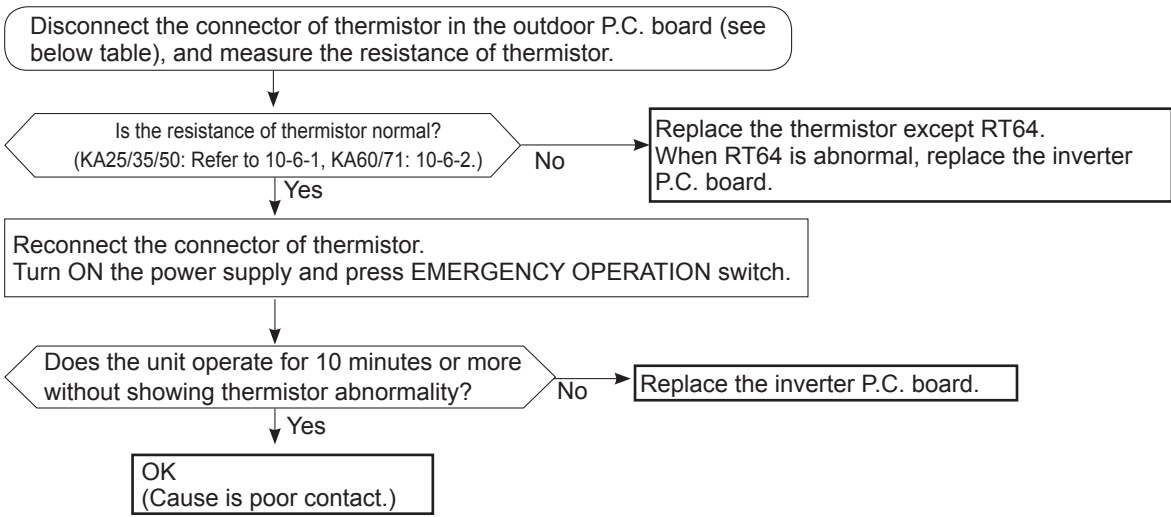

Thermistor	Symbol	Connector, Pin No.		Board
		SUZ-KA25/35/50VA6	SUZ-KA60/71VA6	
Defrost	RT61	Between CN641 pin1 and pin2	Between CN671 pin1 and pin2	Inverter P.C. board
Discharge temperature	RT62	Between CN641 pin3 and pin4	Between CN671 pin3 and pin4	
Fin temperature	RT64	Between CN642 pin1 and pin2	Between CN673 pin1 and pin2	
Ambient temperature	RT65	Between CN643 pin1 and pin2	Between CN672 pin1 and pin2	
Outdoor heat exchanger temperature	RT68	Between CN644 pin1 and pin3	Between CN671 pin5 and pin6	

G Check of R.V. coil

First of all, measure the resistance of R.V. coil to check if the coil is defective. Refer to "10-4. TROUBLE CRITERION OF MAIN PARTS".

In case CN721(KA25/35/50)/CN602(KA60/71) is not connected or R.V. coil is open, voltage is generated between the terminal pins of the connector although any signal is not being transmitted to R.V. coil.

Check if CN721(KA25/35/50)/CN602(KA60/71) is connected.

Unit operates COOL mode even if it is set to HEAT mode.

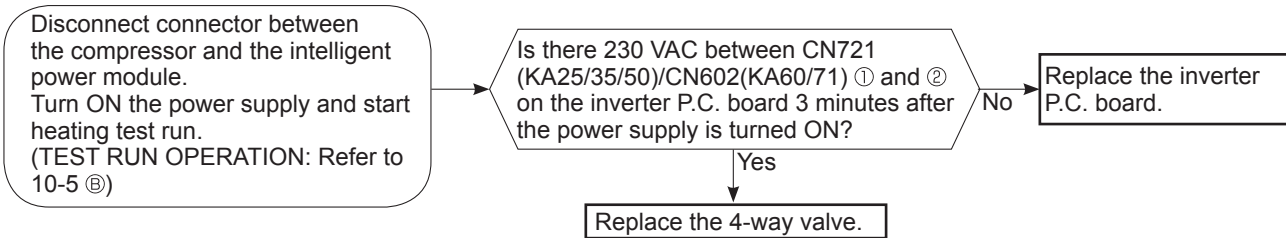

Unit operates HEAT mode even if it is set to COOL mode.

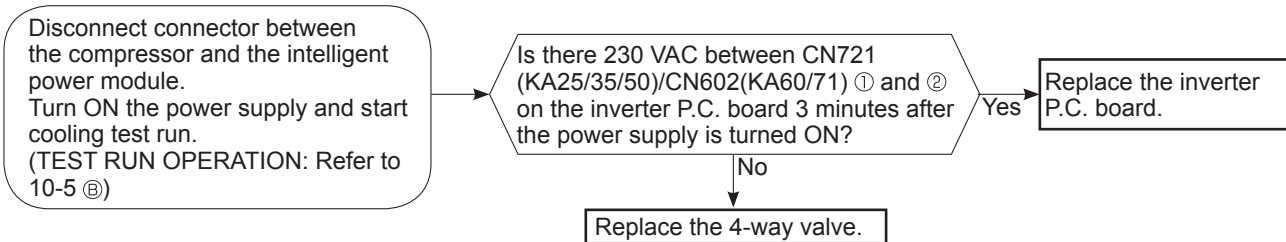

H Check of outdoor fan motor

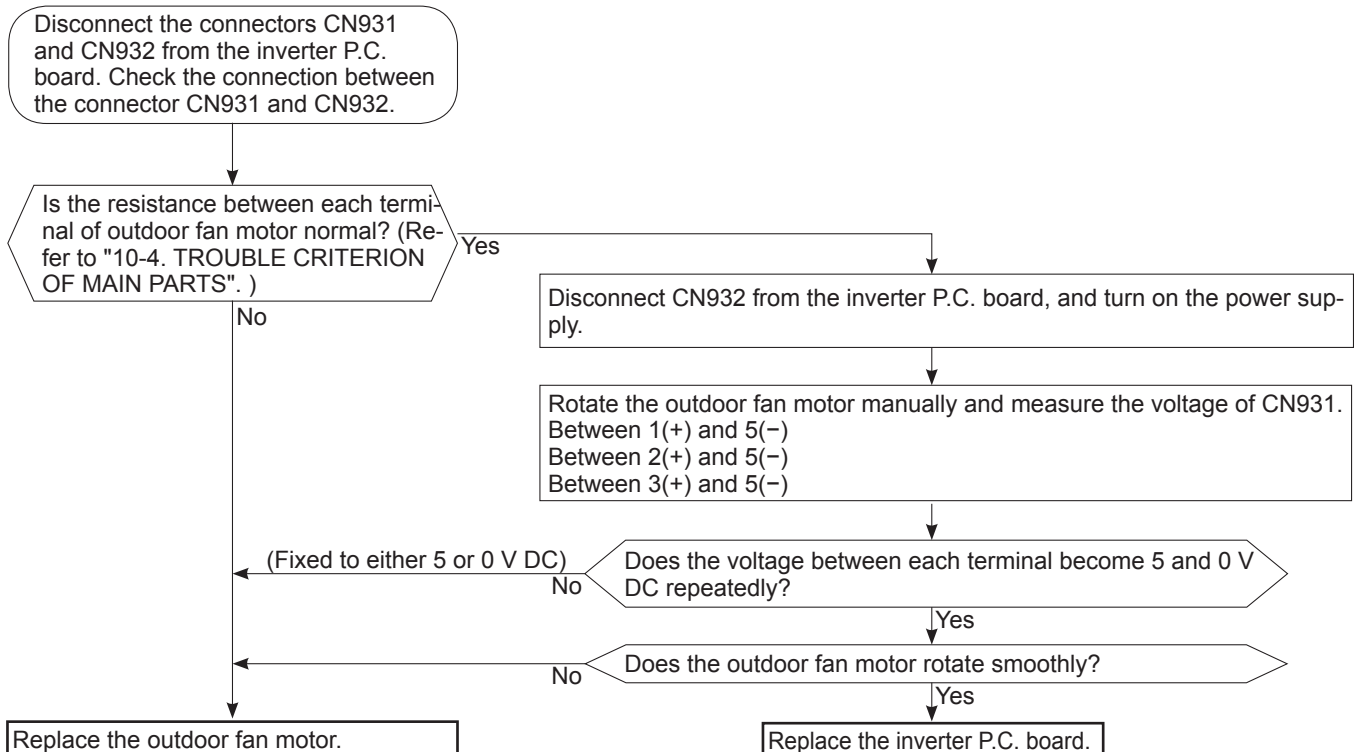

① Check of LEV

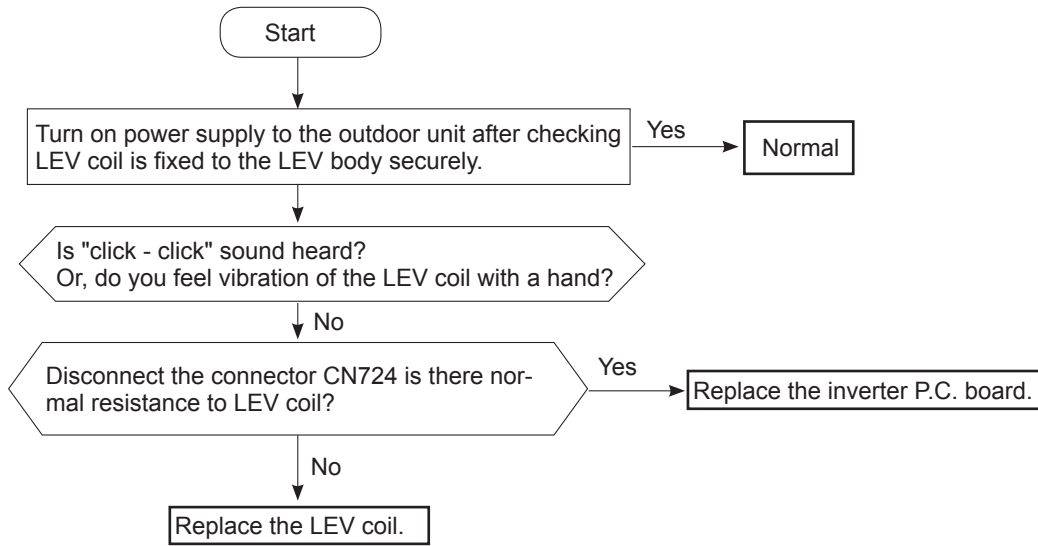

② Check of inverter P.C. board

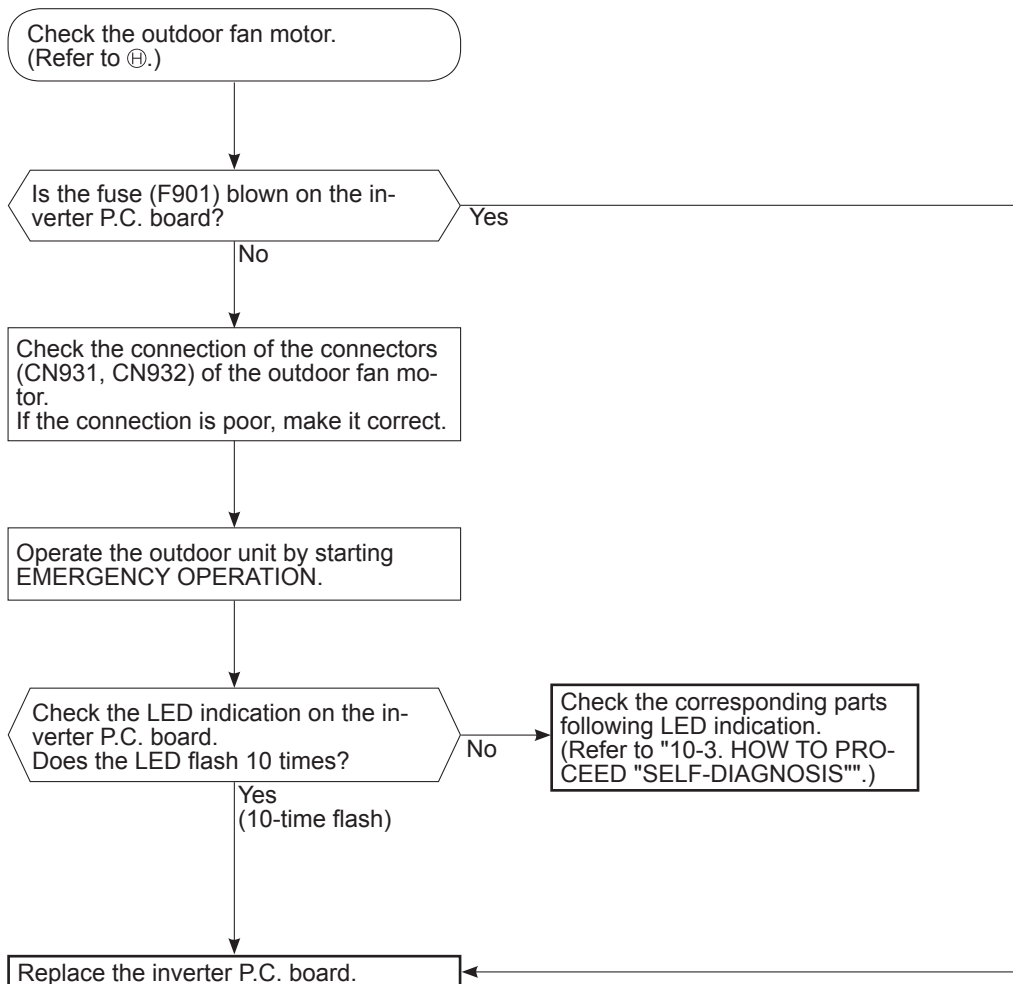

K Electromagnetic noise enters into TV sets or radios

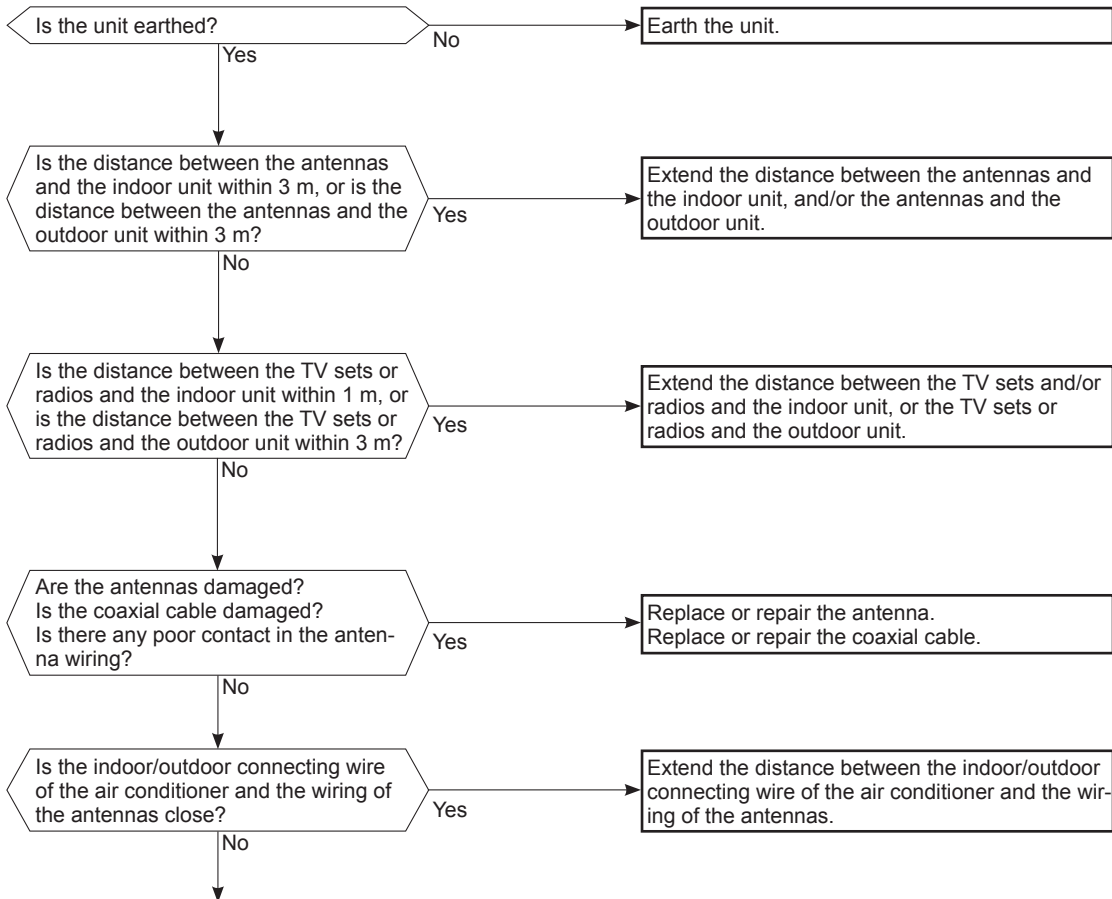

Even if all of the above conditions are fulfilled, the electromagnetic noise may enter, depending on the electric field strength or the installation condition (combination of specific conditions such as antennas or wiring).
Check the following before asking for service.

1. Devices affected by the electromagnetic noise
TV sets, radios (FM/AM broadcast, shortwave)
2. Channel, frequency, broadcast station affected by the electromagnetic noise
3. Channel, frequency, broadcast station unaffected by the electromagnetic noise
4. Layout of ;
indoor/outdoor unit of the air conditioner, indoor/outdoor wiring, earth wire, antennas, wiring from antennas, receiver
5. Electric field intensity of the broadcast station affected by the electromagnetic noise
6. Presence or absence of amplifier such as booster
7. Operation condition of air conditioner when the electromagnetic noise enters in
 - 1) Turn OFF the power supply once, and then turn ON the power supply. In this situation, check for the electromagnetic noise.
 - 2) Within 3 minutes after turning ON the power supply, press OPERATE/STOP (ON/OFF) button on the remote controller for power ON, and check for the electromagnetic noise.
 - 3) After a short time (3 minutes later after turning ON), the outdoor unit starts running. During operation, check for the electromagnetic noise.
 - 4) Press OPERATE/STOP (ON/OFF) button on the remote controller for power OFF, when the outdoor unit stops but the indoor/outdoor communication still runs on. In this situation, check for the electromagnetic noise.

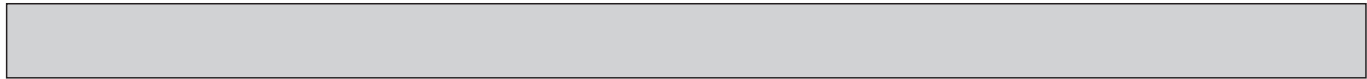

L Check of outdoor refrigerant circuit

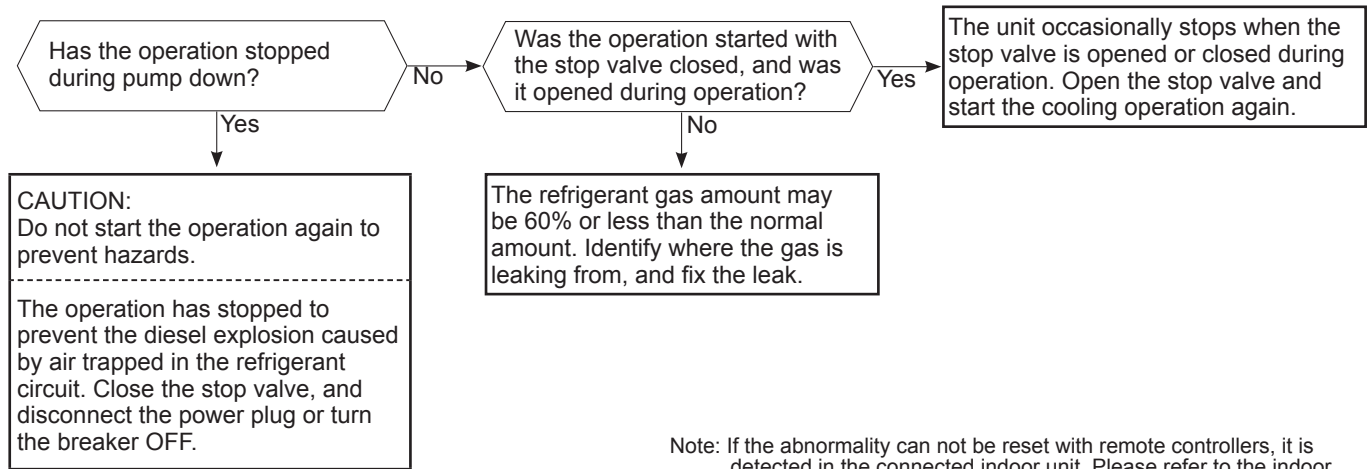

Note: If the abnormality can not be reset with remote controllers, it is detected in the connected indoor unit. Please refer to the indoor unit's service manual.

10-6. TEST POINT DIAGRAM AND VOLTAGE

10-6-1. Inverter P.C. board

SUZ-KA25VA6.TH
 SUZ-KA25VA6.TH-ER
 SUZ-KA25VA6.TH-ET

SUZ-KA35VA6.TH
 SUZ-KA35VA6.TH-ER
 SUZ-KA35VA6.TH-ET

SUZ-KA50VA6.TH
 SUZ-KA50VA6.TH-ER
 SUZ-KA50VA6.TH-ET

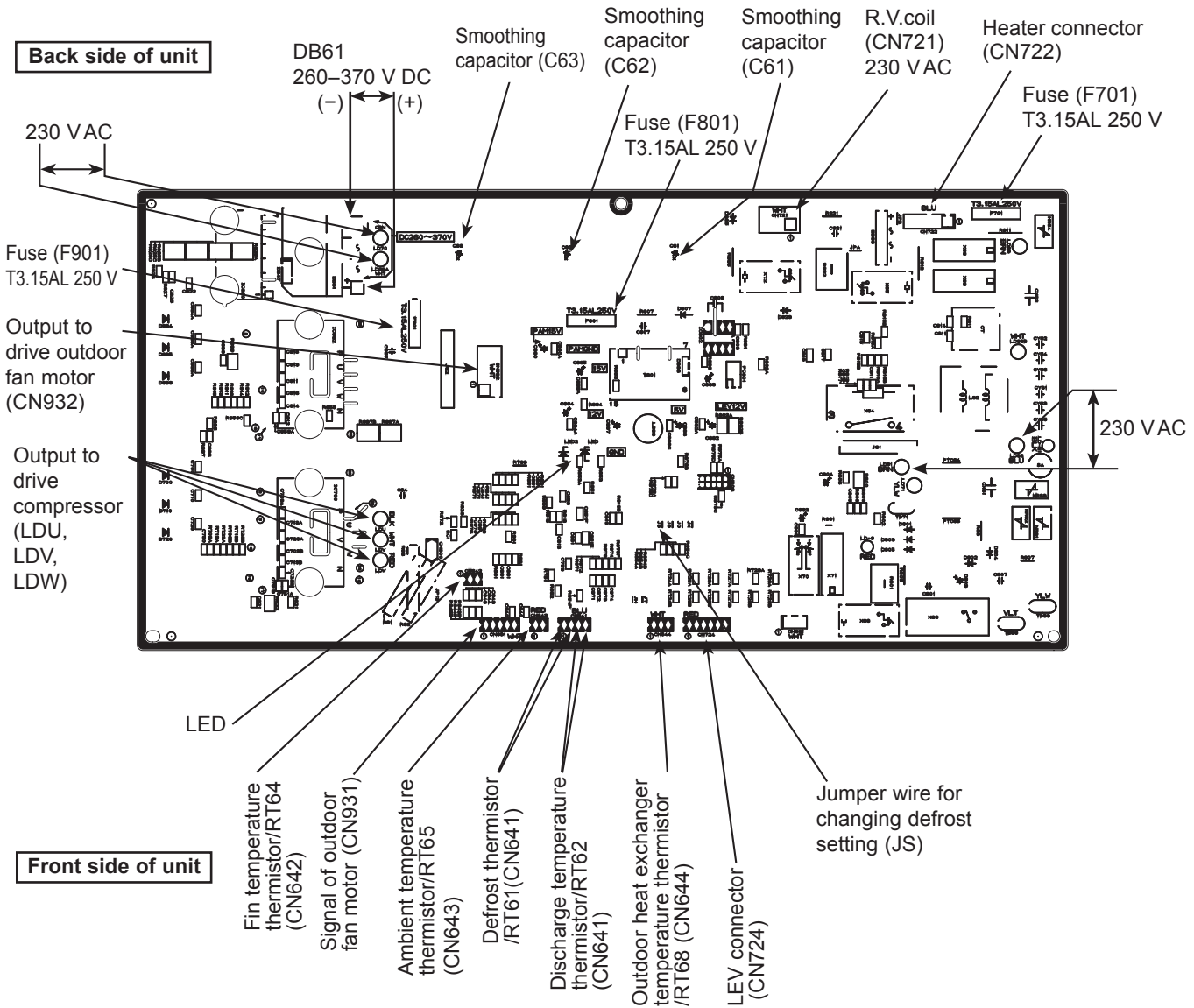

Defrost thermistor(RT61)
 Ambient temperature thermistor(RT65)
 Outdoor heat exchanger temperature thermistor(RT68)

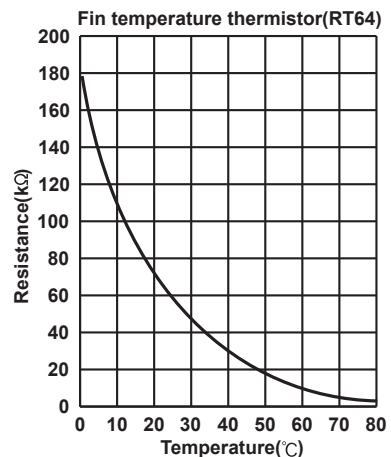
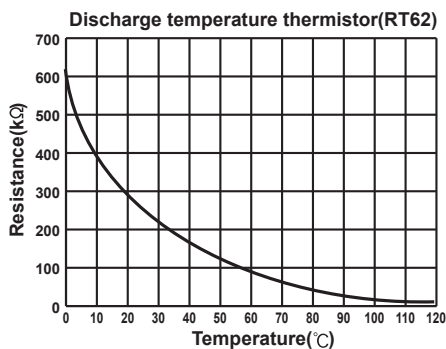
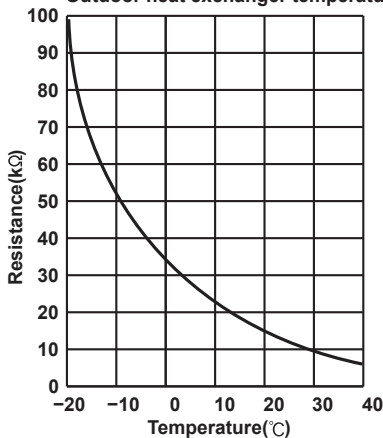

10-6-2. Inverter P.C. board

SUZ-KA60VA6.TH

SUZ-KA60VA6.TH-ER

SUZ-KA60VA6.TH-ET

SUZ-KA71VA6.TH

SUZ-KA71VA6.TH-ER

SUZ-KA71VA6.TH-ET

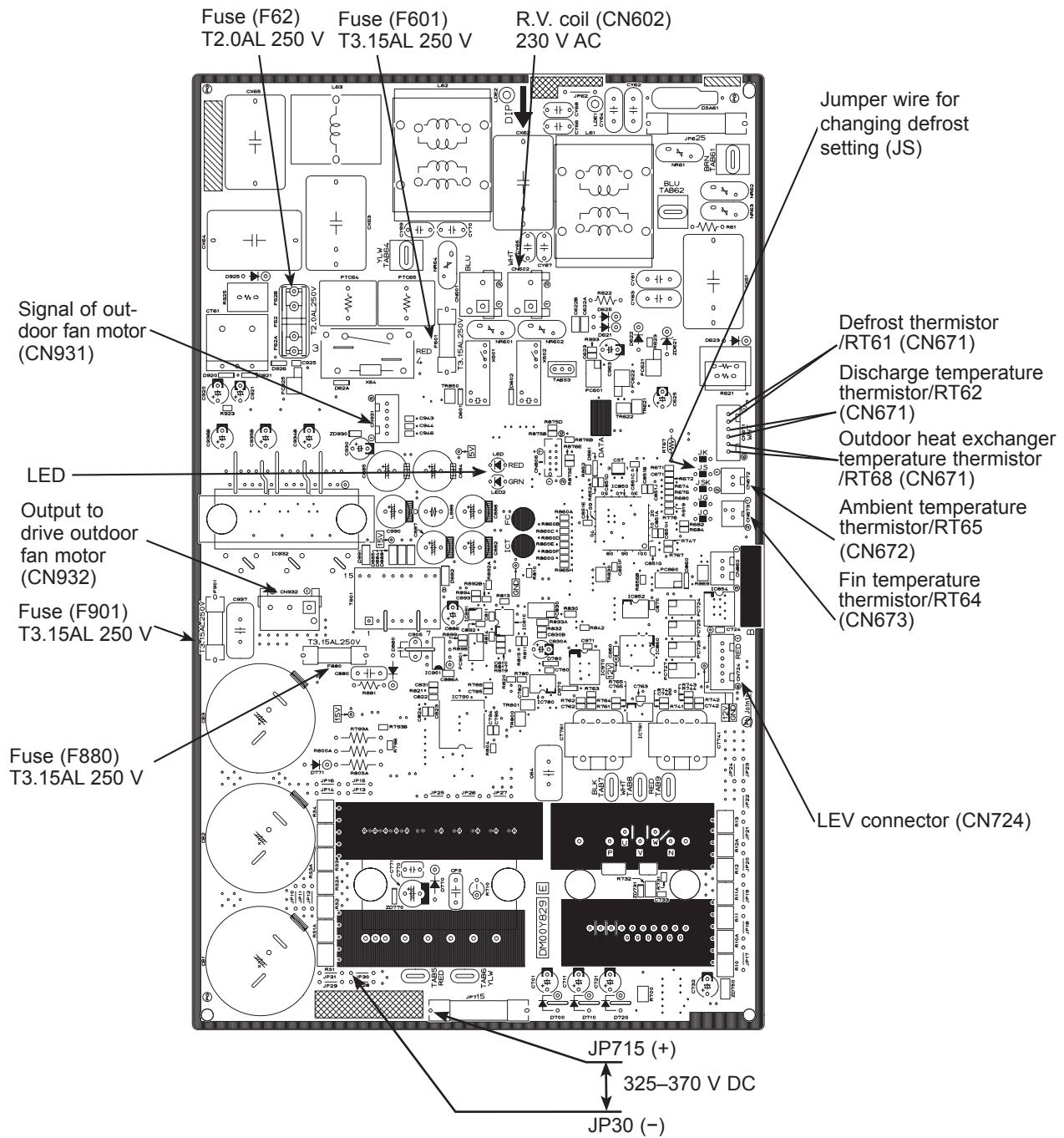

Defrost thermistor(RT61)
Ambient temperature thermistor(RT65)
Outdoor heat exchanger temperature thermistor(RT68)

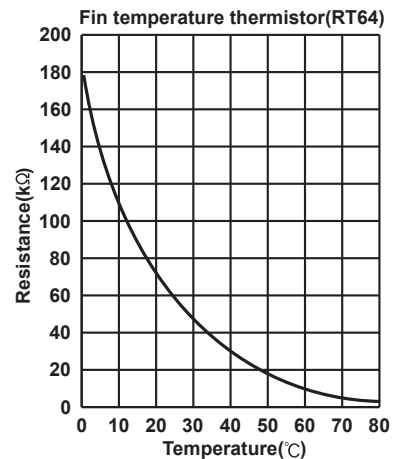
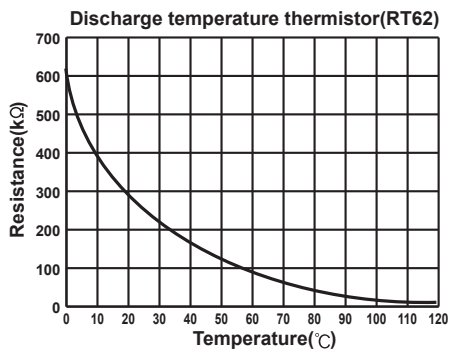
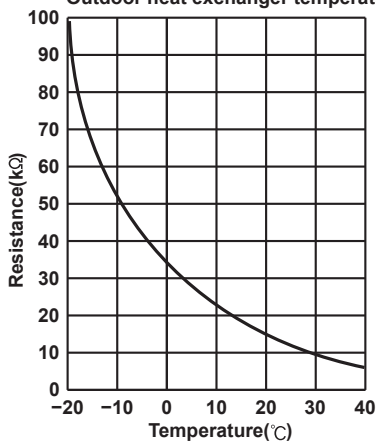

<"Terminal with locking mechanism" Detaching points>

The terminal which has the locking mechanism can be detached as shown below.
 There are 2 types (Refer to (1) and (2)) of the terminal with locking mechanism.
 The terminal without locking mechanism can be detached by pulling it out.
 Check the shape of the terminal before detaching.

(1) Slide the sleeve and check if there is a locking lever or not.

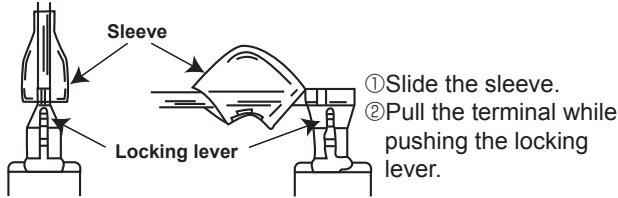

(2) The terminal with this connector has the locking mechanism.

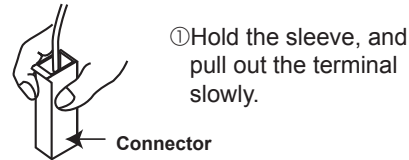

SUZ-KA25VA6.TH
 SUZ-KA25VA6.TH-ER
 SUZ-KA25VA6.TH-ET

SUZ-KA35VA6.TH
 SUZ-KA35VA6.TH-ER
 SUZ-KA35VA6.TH-ET

NOTE: Turn OFF power supply before disassembling.

OPERATING PROCEDURE	PHOTOS
<p>1. Removing the cabinet</p> <ol style="list-style-type: none"> (1) Remove the screw fixing the service panel. (2) Pull down the service panel and remove it. (3) Disconnect the power supply and indoor/outdoor connecting wire. (4) Remove the screws fixing the top panel. (5) Remove the top panel. (6) Remove the screws fixing the cabinet. (7) Remove the cabinet. (8) Remove the screws fixing the back panel. (9) Remove the back panel. 	<p>Photo 1</p> <p>Photo 2</p>

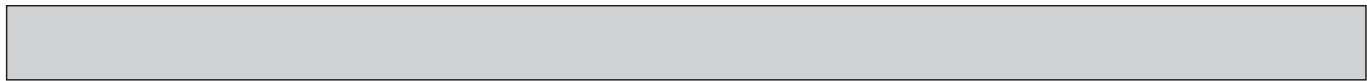

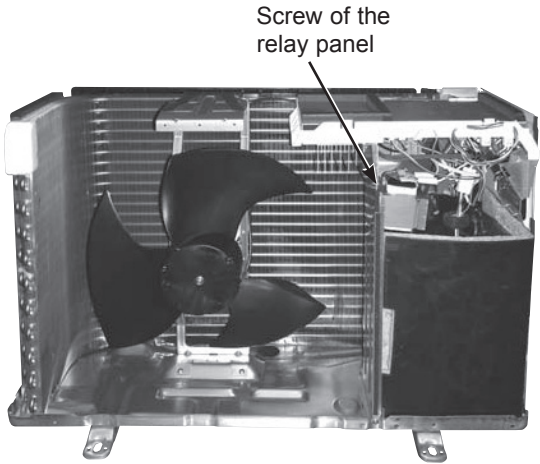
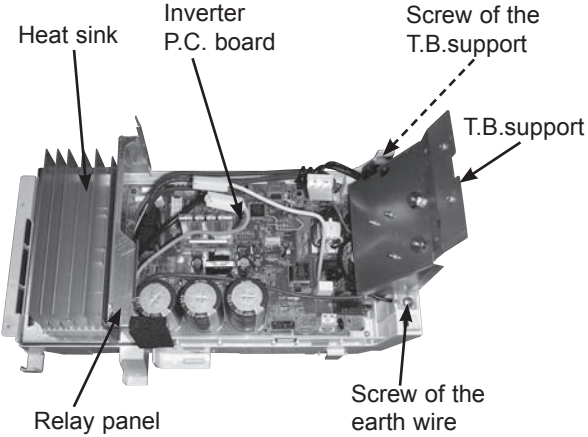
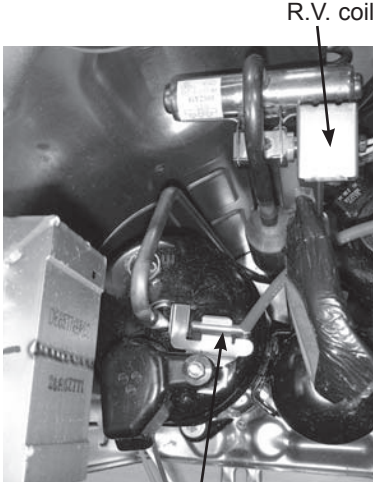
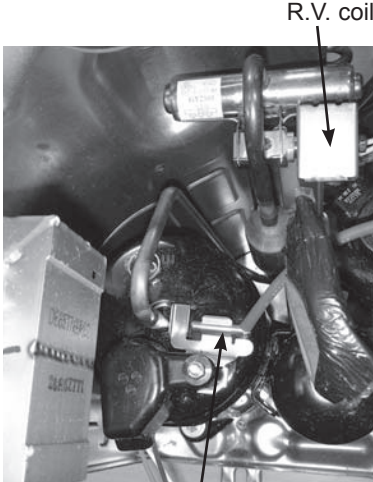
OPERATING PROCEDURE	PHOTOS
<p>2. Removing the inverter assembly, inverter P.C. board</p> <p>(1) Remove the cabinet and panels. (Refer to procedure 1.)</p> <p>(2) Disconnect the lead wire to the reactor and the following connectors:</p> <p><Inverter P.C. board></p> <p>CN721 (R.V. coil)</p> <p>CN932 (Fan motor)</p> <p>CN641 (Defrost thermistor and discharge temperature thermistor)</p> <p>CN643 (Ambient temperature thermistor)</p> <p>CN644 (Outdoor heat exchanger temperature thermistor)</p> <p>CN724 (LEV)</p> <p>(3) Remove the compressor connector (CN61).</p> <p>(4) Remove the screws fixing the relay panel. (Photo 3)</p> <p>(5) Remove the inverter assembly. (Photo 4)</p> <p>(6) Remove the screw of the earth wire and screw of the T.B.support. (Photo 4)</p> <p>(7) Remove the relay panel from the inverter assembly.</p> <p>(8) Remove the inverter P.C. board from the relay panel.</p>	<p>Photo 3</p>  <p>Photo 4 (Inverter assembly)</p> 
<p>3. Removing R.V. coil</p> <p>(1) Remove the cabinet and panels. (Refer to procedure 1.)</p> <p>(2) Disconnect the following connectors:</p> <p><Inverter P.C. board></p> <p>CN721 (R.V. coil)</p> <p>(3) Remove the R.V. coil. (Photo 5)</p>	<p>Photo 5</p> 
<p>4. Removing the discharge temperature thermistor, defrost thermistor, outdoor heat exchanger temperature thermistor and ambient temperature thermistor</p> <p>(1) Remove the cabinet and panels. (Refer to procedure 1.)</p> <p>(2) Disconnect the lead wire to the reactor and the following connectors:</p> <p><Inverter P.C. board></p> <p>CN641 (Defrost thermistor and discharge temperature thermistor)</p> <p>CN643 (Ambient temperature thermistor)</p> <p>CN644 (Outdoor heat exchanger temperature thermistor)</p> <p>(3) Pull out the discharge temperature thermistor from its holder. (Photo 5)</p> <p>(4) Pull out the defrost thermistor from its holder. (Photo 6)</p> <p>(5) Pull out the outdoor heat exchanger temperature thermistor from its holder. (Photo 6)</p> <p>(6) Pull out the ambient temperature thermistor from its holder.</p>	<p>Photo 5</p> 

OPERATING PROCEDURE

5. Removing outdoor fan motor

- (1) Remove the cabinet and panels. (Refer to procedure 1.)
- (2) Disconnect the following connectors:
<Inverter P.C. board>
CN932 (Fan motor)
- (3) Remove the propeller nut. (Photo 7)
- (4) Remove the propeller. (Photo 7)
- (5) Remove the screws fixing the fan motor. (Photo 7)
- (6) Remove the fan motor.

6. Removing the compressor and 4-way valve

- (1) Remove the cabinet and panels. (Refer to procedure 1.)
- (2) Remove the inverter assembly. (Refer to procedure 2.)
- (3) Recover gas from the refrigerant circuit.
NOTE: Recover gas from the pipes until the pressure gauge shows 0 kg/cm² (0 MPa).
- (4) Detach the welded part of the suction and the discharge pipe connected with compressor.
- (5) Remove the nuts of compressor legs.
- (6) Remove the compressor.
- (7) Detach the welded part of pipes connected with 4-way valve. (Photo 8)

PHOTOS

Photo 6

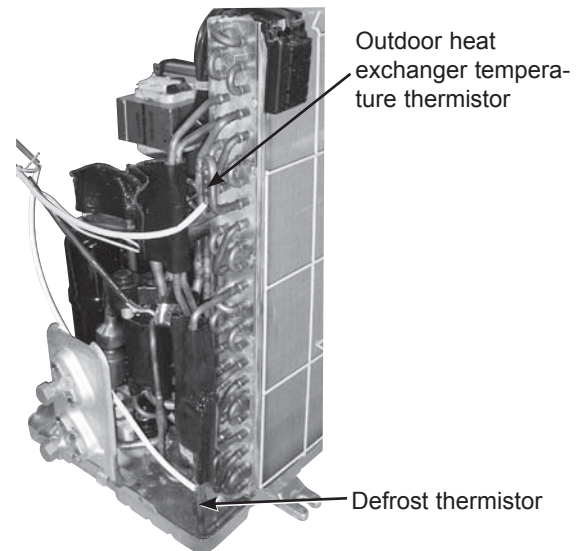

Photo 7

Screws of the outdoor fan motor

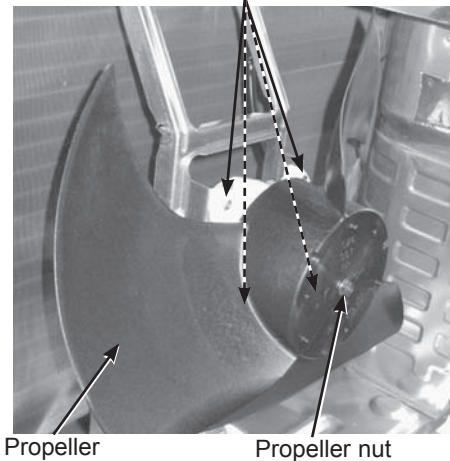
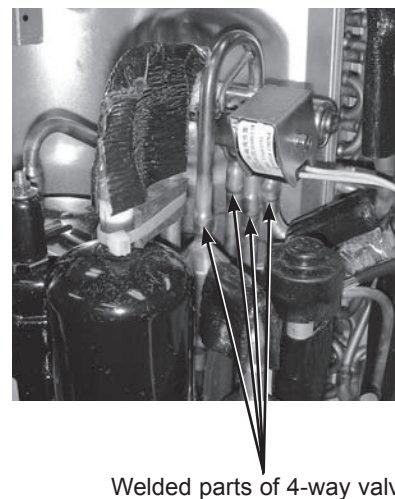
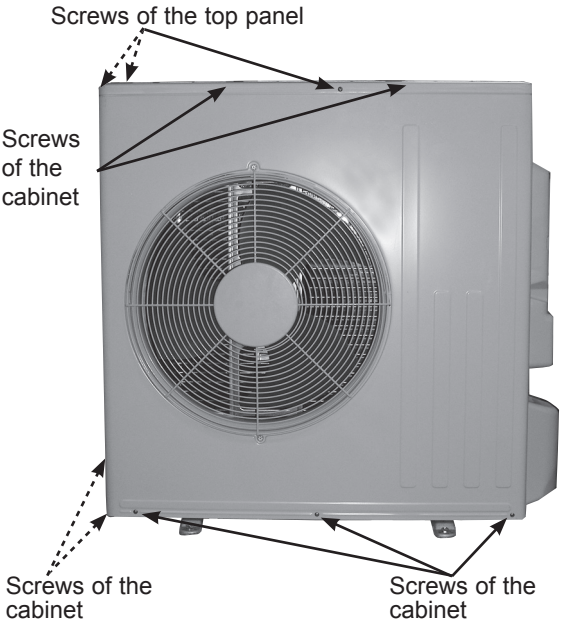
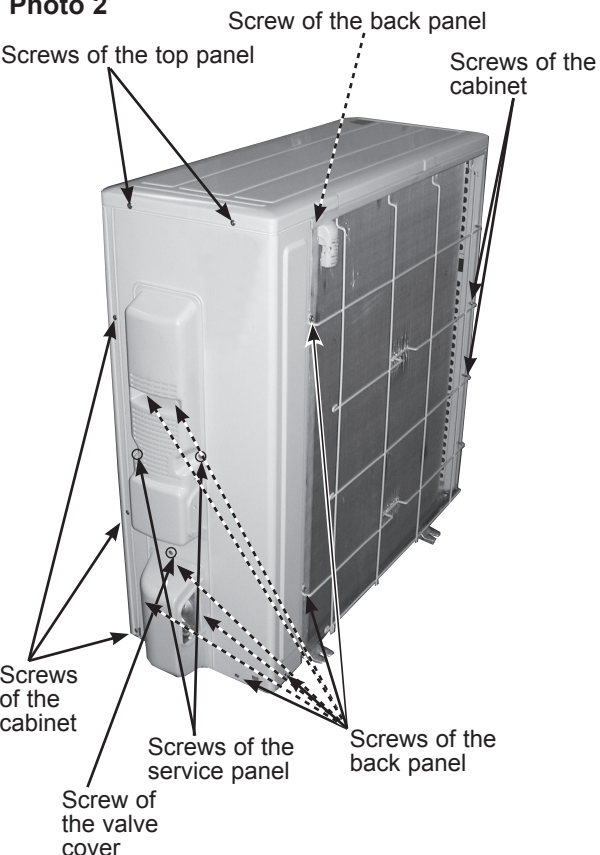

Photo 8



SUZ-KA50VA6.TH
SUZ-KA50VA6.TH-ER
SUZ-KA50VA6.TH-ET

NOTE: Turn OFF power supply before disassembly.

OPERATING PROCEDURE	PHOTOS
<p>1. Removing the cabinet</p> <ol style="list-style-type: none"> (1) Remove the screws of the service panel. (2) Remove the screws of the top panel. (3) Remove the screw of the valve cover. (4) Remove the service panel. (5) Remove the top panel. (6) Remove the valve cover. (7) Disconnect the power supply and indoor/outdoor connecting wire. (8) Remove the screws of the cabinet. (9) Remove the cabinet. (10) Remove the screws of the back panel. (11) Remove the back panel. 	<p>Photo 1</p>  <p>Screws of the top panel</p> <p>Screws of the cabinet</p> <p>Screws of the cabinet</p> <p>Screws of the cabinet</p> <p>Photo 2</p>  <p>Screw of the back panel</p> <p>Screws of the top panel</p> <p>Screws of the cabinet</p> <p>Screws of the cabinet</p> <p>Screws of the back panel</p> <p>Screws of the service panel</p> <p>Screw of the valve cover</p>

OPERATING PROCEDURE

PHOTOS

2. Removing the inverter assembly, inverter P.C. board

- (1) Remove the cabinet and panels. (Refer to procedure 1.)
- (2) Disconnect the lead wire to the reactor and the following connectors:
<Inverter P.C. board>
CN721 (R.V. coil)
CN931, CN932 (Fan motor)
CN641 (Defrost thermistor and discharge temperature thermistor)
CN643 (Ambient temperature thermistor)
CN644 (Outdoor heat exchanger temperature thermistor)
CN724 (LEV)
- (3) Remove the compressor connector.
- (4) Remove the screws fixing the heat sink support and the separator.
- (5) Remove the fixing screws of the terminal block support and the back panel.
- (6) Remove the inverter assembly.
- (7) Remove the screw of the earth wire, screw of the P.C. board cover and screws of the terminal block support.
- (8) Remove the heat sink support from the P.C. board support.
- (9) Remove the screw of the inverter P.C. board and the inverter P.C. board from the P.C. board support.

Photo 3

Screw of the heat sink support and the separator

Screws of the terminal block support and the back panel

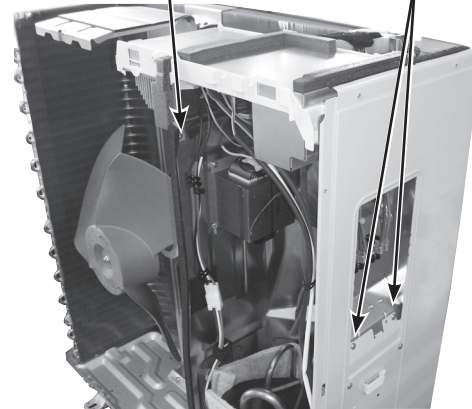
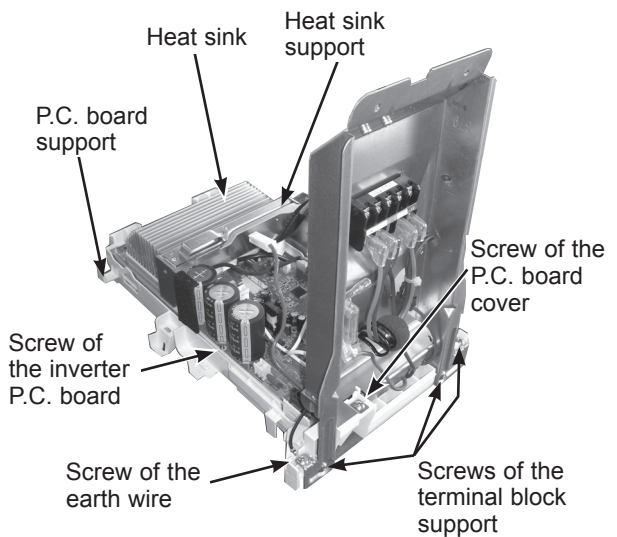

Photo 4



3. Removing R.V. coil

- (1) Remove the cabinet and panels. (Refer to procedure 1.)
- (2) Disconnect the following connector:
<Inverter P.C. board>
CN721 (R.V. coil)
- (3) Remove the R.V. coil.

Photo 5

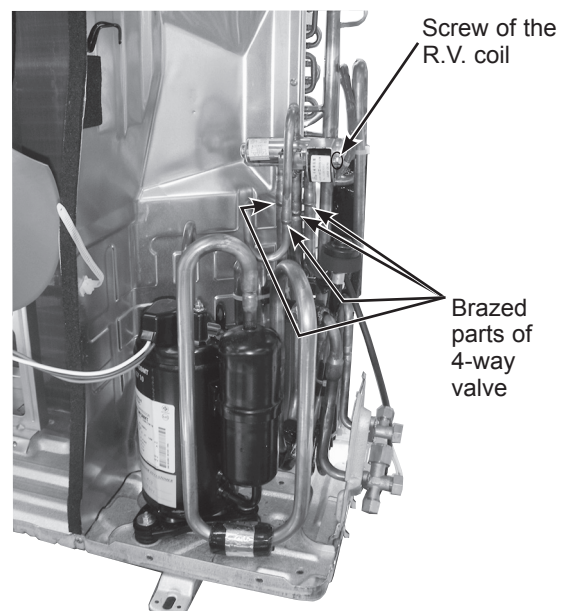

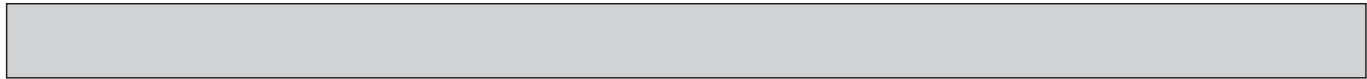

OPERATING PROCEDURE

PHOTOS

4. Removing the discharge temperature thermistor, defrost thermistor, outdoor heat exchanger temperature thermistor and ambient temperature thermistor

- (1) Remove the cabinet and panels. (Refer to procedure 1.)
- (2) Disconnect the lead wire to the reactor and the following connectors:
<Inverter P.C. board>
CN641 (Defrost thermistor and discharge temperature thermistor)
CN643 (Ambient temperature thermistor)
CN644 (Outdoor heat exchanger temperature thermistor)
- (3) Pull out the discharge temperature thermistor from its holder.
- (4) Pull out the defrost thermistor from its holder.
- (5) Pull out the outdoor heat exchanger temperature thermistor from its holder.
- (6) Pull out the ambient temperature thermistor from its holder.

Photo 6

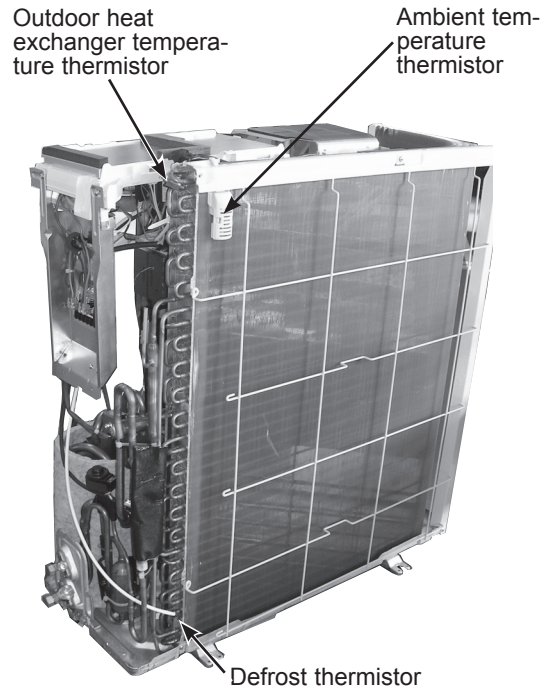

5. Removing outdoor fan motor

- (1) Remove the top panel, cabinet and service panel. (Refer to procedure 1.)
- (2) Disconnect the following connectors:
<Inverter P.C. board>
CN931 and CN932 (Fan motor)
- (3) Remove the propeller nut.
- (4) Remove the propeller.
- (5) Remove the screws fixing the fan motor.
- (6) Remove the fan motor.

Photo 7

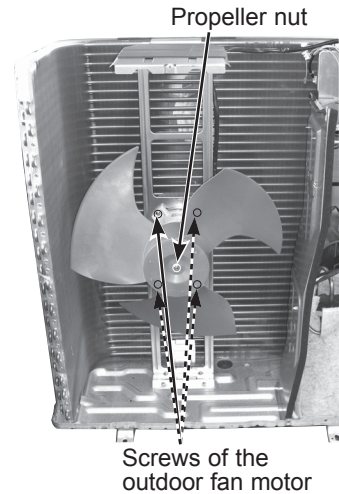

6. Removing the compressor and 4-way valve

- (1) Remove the top panel, cabinet and service panel. (Refer to procedure 1.)
 - (2) Remove the back panel. (Refer to procedure 1.)
 - (3) Remove the inverter assembly. (Refer to procedure 2.)
 - (4) Recover gas from the refrigerant circuit.
- NOTE:** Recover gas from the pipes until the pressure gauge shows 0 kg/cm² (0 MPa).
- (5) Detach the brazed part of the suction and the discharge pipe connected with compressor.
 - (6) Remove the compressor nuts.
 - (7) Remove the compressor.
 - (8) Detach the brazed part of 4-way valve and pipe. (Photo 5)

Photo 8

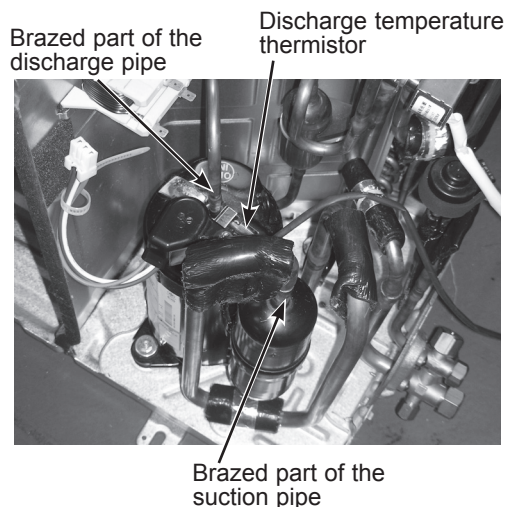

SUZ-KA60VA6.TH
SUZ-KA60VA6.TH-ER
SUZ-KA60VA6.TH-ET

SUZ-KA71VA6.TH
SUZ-KA71VA6.TH-ER
SUZ-KA71VA6.TH-ET

NOTE: Turn OFF power supply before disassembling.

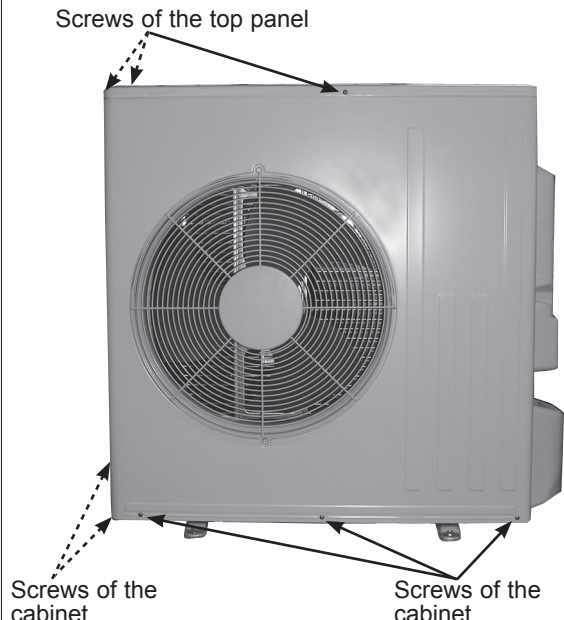
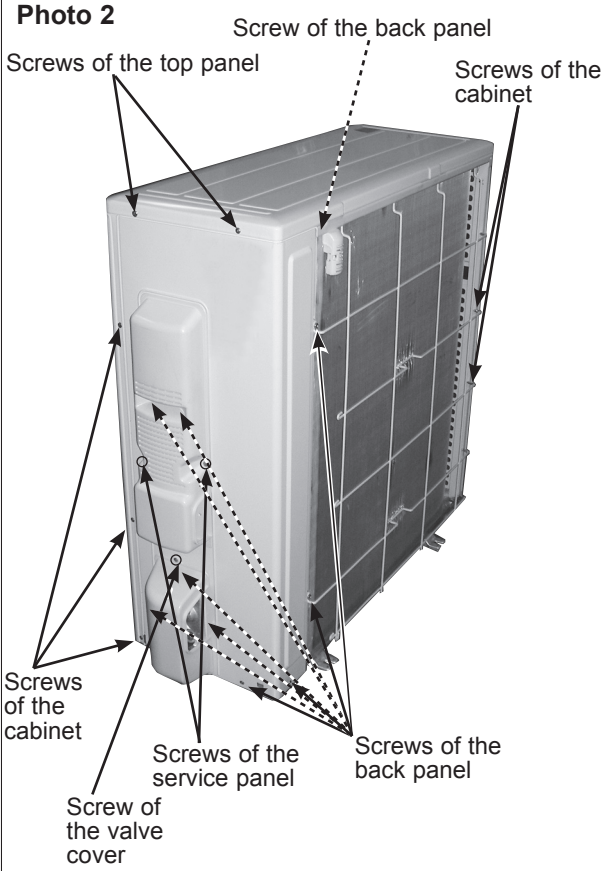
OPERATING PROCEDURE	PHOTOS
<p>1. Removing the cabinet</p> <ol style="list-style-type: none">(1) Remove the screws of the service panel.(2) Remove the screws of the top panel.(3) Remove the screw of the valve cover.(4) Remove the service panel.(5) Remove the top panel.(6) Remove the valve cover.(7) Disconnect the power supply and indoor/outdoor connecting wire.(8) Remove the screws of the cabinet.(9) Remove the cabinet.(10) Remove the screws of the back panel.(11) Remove the back panel.	<p>Photo 1</p>  <p>Screws of the top panel</p> <p>Screws of the cabinet</p> <p>Screws of the cabinet</p> <p>Photo 2</p>  <p>Screw of the back panel</p> <p>Screws of the top panel</p> <p>Screws of the cabinet</p> <p>Screws of the cabinet</p> <p>Screws of the service panel</p> <p>Screws of the back panel</p> <p>Screw of the valve cover</p>

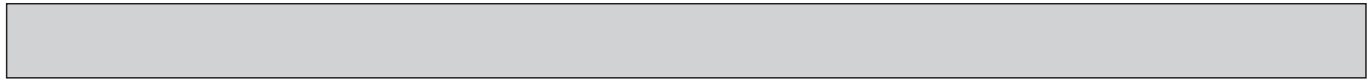

OPERATING PROCEDURE

2. Removing the inverter assembly, inverter P.C. board

(1) Remove the cabinet and panels. (Refer to procedure 1.)

(2) Disconnect the lead wire to the reactor and the following connectors:
<Inverter P.C. board>
CN602 (R.V. coil)
CN931, CN932 (Fan motor)
CN671 (Defrost thermistor, discharge temperature thermistor and outdoor heat exchanger temperature thermistor)
CN672 (Ambient temperature thermistor)
CN724 (LEV)

(3) Remove the compressor connector.

(4) Remove the screws fixing the relay panel.

(5) Remove the relay panel.

(6) Remove the earth wires and the lead wires of the inverter P.C. board.

(7) Remove the screws of the PB support.

(8) Remove the inverter P.C. board from the relay panel.

3. Removing R.V. coil

(1) Remove the cabinet and panels. (Refer to procedure 1.)

(2) Disconnect the following connector:
<Inverter P.C. board>
CN602 (R.V. coil)

(3) Remove the R.V. coil.

PHOTOS

Photo 3

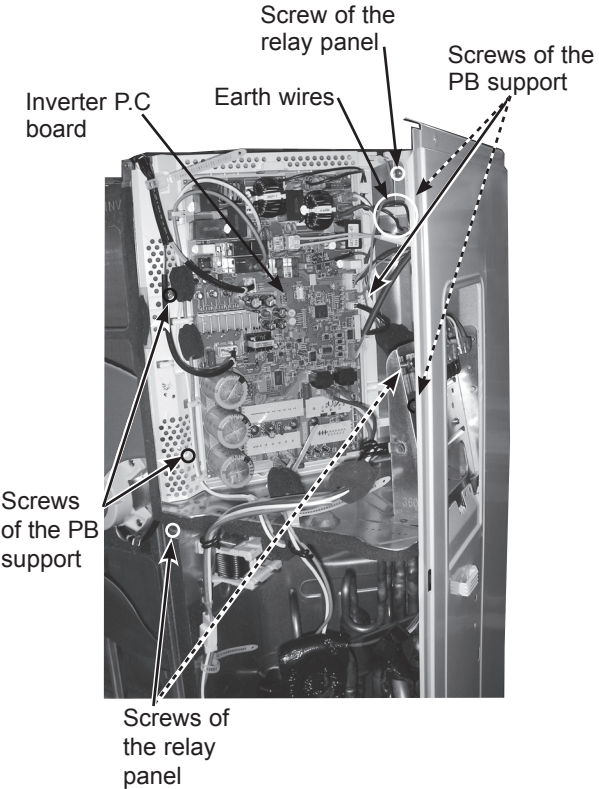
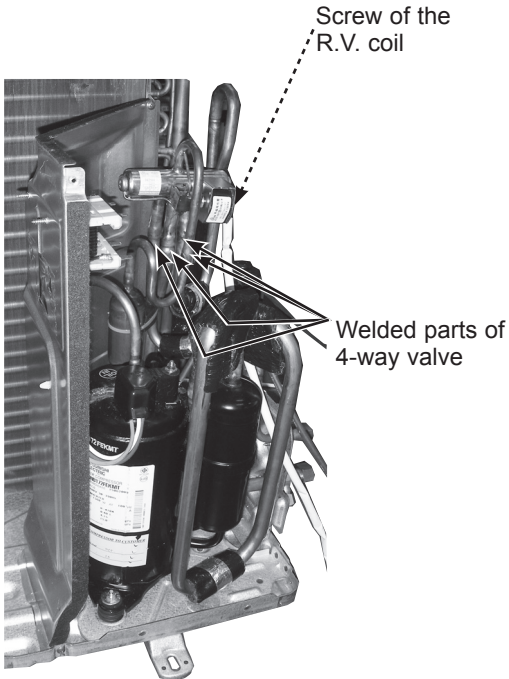

Photo 4



OPERATING PROCEDURE

4. Removing the discharge temperature thermistor, defrost thermistor, outdoor heat exchanger temperature thermistor and ambient temperature thermistor

- (1) Remove the cabinet and panels. (Refer to procedure 1.)
- (2) Disconnect the lead wire to the reactor and the following connectors:
<Inverter P.C. board>
CN671 (Defrost thermistor, discharge temperature thermistor and outdoor heat exchanger temperature thermistor)
CN672 (Ambient temperature thermistor)
- (3) Pull out the discharge temperature thermistor from its holder. (Photo 7)
- (4) Pull out the defrost thermistor from its holder.
- (5) Pull out the outdoor heat exchanger temperature thermistor from its holder.
- (6) Pull out the ambient temperature thermistor from its holder.

5. Removing outdoor fan motor

- (1) Remove the top panel, cabinet and service panel. (Refer to 1.)
- (2) Disconnect the following connectors:
<Inverter P.C. board>
CN931 and CN932 (Fan motor)
- (3) Remove the propeller.
- (4) Remove the screws fixing the fan motor.
- (5) Remove the fan motor.

6. Removing the compressor and 4-way valve

- (1) Remove the top panel, cabinet and service panel. (Refer to procedure 1.)
- (2) Remove the back panel. (Refer to procedure 1.)
- (3) Remove the inverter assembly. (Refer to procedure 2.)
- (4) Recover gas from the refrigerant circuit.
NOTE: Recover gas from the pipes until the pressure gauge shows 0 kg/cm² (0 MPa).
- (5) Detach the welded part of the suction and the discharge pipe connected with compressor.
- (6) Remove the compressor nuts.
- (7) Remove the compressor.
- (8) Detach the welded part of 4-way valve and pipe. (Photo 4)

PHOTOS

Photo 5

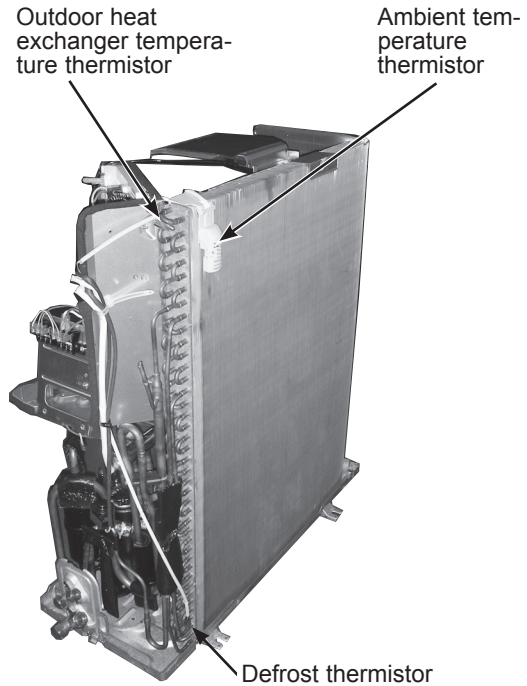

Photo 6

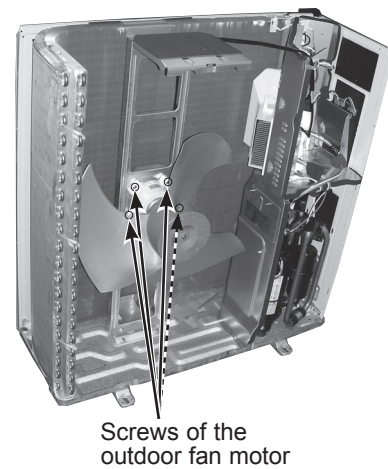
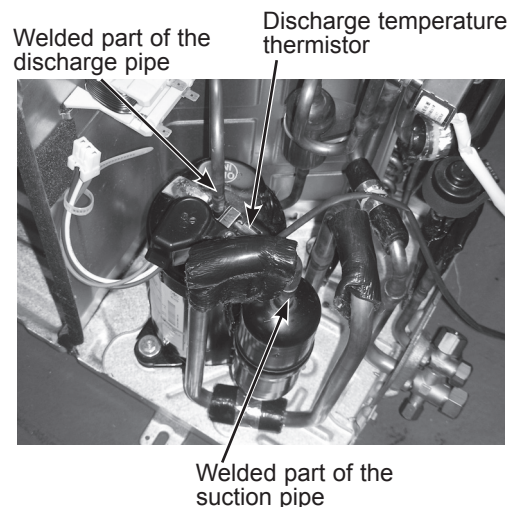

Photo 7



Mr. SLIM

mitsubishi electric corporation

HEAD OFFICE: TOKYO BUILDING, 2-7-3, MARUNOUCHI, CHIYODA-KU, TOKYO 100-8310, JAPAN

mitsubishi electric consumer products (thailand) co., ltd.
AMATA NAKORN INDUSTRIAL ESTATE
700/406 MOO 7, TAMBON DON HUA ROH,
AMPHUR MUANG, CHONBURI 20000 THAILAND
Made in Thailand

New publication, effective Nov. 2016
Specifications are subject to change without notice.