

# SERVICE MANUAL R410A

**Outdoor unit  
[Model Name]**

PUAZ-SW160YKA

**[Service Ref.]**
**PUHZ-SW160YKA.UK**
**PUHZ-SW160YKAR1.UK**

PUAZ-SW200YKA

**PUHZ-SW200YKA.UK**
**PUHZ-SW200YKAR1.UK**
**Salt proof model**

PUAZ-SW160YKA-BS

**PUHZ-SW160YKA-BS.UK**
**PUHZ-SW160YKAR1-BS.UK**

PUAZ-SW200YKA-BS

**PUHZ-SW200YKA-BS.UK**
**PUHZ-SW200YKAR1-BS.UK**
**Revision:**

- PUAZ-SW160YKAR1.UK, PUAZ-SW160YKAR1-BS.UK, PUAZ-SW200YKAR1.UK and PUAZ-SW200YKAR1-BS.UK in REVISED EDITION-A.
- Some descriptions have been modified.

- Please void OCH583.

**Note:**

- This manual describes service data of the indoor units only.

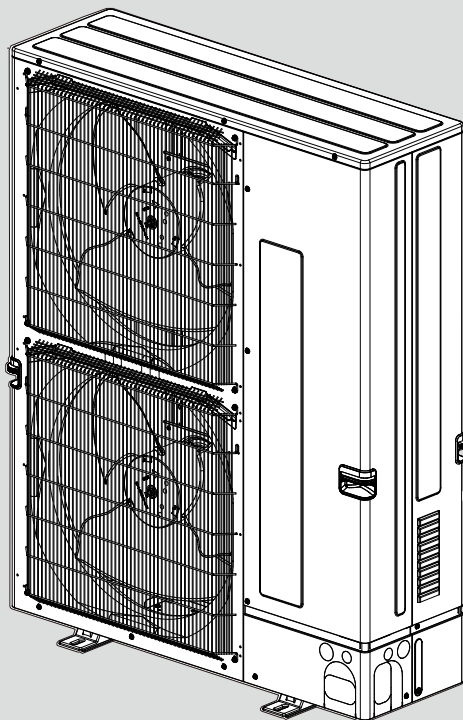

## CONTENTS

TECHNICAL CHANGES .....	2
1. REFERENCE MANUAL .....	2
2. SAFETY PRECAUTION .....	2
3. FEATURES .....	6
4. SPECIFICATIONS .....	7
5. DATA .....	8
6. OUTLINES AND DIMENSIONS .....	11
7. WIRING DIAGRAM .....	12
8. WIRING SPECIFICATIONS .....	13
9. REFRIGERANT SYSTEM DIAGRAM .....	15
10. TROUBLESHOOTING .....	17
11. DISASSEMBLY PROCEDURE .....	60

PARTS CATALOG (OCB583)

# TECHNICAL CHANGES

Service ref. have been changed as follows.

PUHZ-SW160YKA(-BS).UK → PUHZ-SW160YKAR1(-BS).UK  
 PUHZ-SW200YKA(-BS).UK → PUHZ-SW200YKAR1(-BS).UK

1. A compliance with ErP directive Lot1 has been authorized.

## 1 REFERENCE MANUAL

### INDOOR UNIT SERVICE MANUAL

Model Name	Service Ref.	Service Manual No.
ERSE-YM9EC ERSE-MEC EHSE-YM9EC EHSE-MEC	ERSE-YM9EC.UK ERSE-YM9ECR1.UK ERSE-MEC.UK ERSE-MECR1.UK EHSE-YM9EC.UK EHSE-YM9ECR1.UK EHSE-MEC.UK EHSE-MECR1.UK	OCH590 OCB590
PAC-IF012B-E PAC-IF021B-E PAC-IF032B-E	PAC-IF012B-E PAC-IF021B-E PAC-IF032B-E	OCB427
PAC-SIF051B-E	PAC-SIF051B-E	OCB536
PAC-IF061B-E PAC-IF062B-E PAC-IF063B-E	PAC-IF061B-E PAC-IF062B-E PAC-IF063B-E	OCB572

## 2 SAFETY PRECAUTION

### 2-1. ALWAYS OBSERVE FOR SAFETY

Before obtaining access to terminal, all supply circuits must be disconnected.

### 2-2. CAUTIONS RELATED TO NEW REFRIGERANT

Cautions for units utilizing refrigerant R410A

#### Preparation before the repair service.

- Prepare the proper tools.
- Prepare the proper protectors.
- Provide adequate ventilation.
- After stopping the operation of the air conditioner, turn off the power-supply beaker.
- Discharge the condenser before the work involving the electric parts.

#### Precautions during the repair service.

- Do not perform the work involving the electric parts with wet hands.
- Do not pour water into the electric parts.
- Do not touch the refrigerant.
- Do not touch the hot or cold areas in the refrigerating cycle.
- When the repair or the inspection of the circuit needs to be done without turning off the power, exercise great caution not to touch the live parts.

### Use new refrigerant pipes.

In case of using the existing pipes for R22, be careful with the following:

- Be sure to clean the pipes and make sure that the insides of the pipes are clean.
- Change flare nut to the one provided with this product. Use a newly flared pipe.
- Avoid using thin pipes.

**Make sure that the inside and outside of refrigerant piping is clean and it has no contaminants such as sulfur, oxides, dirt, shaving particles, etc, which are hazard to refrigerant cycle. In addition, use pipes with specified thickness.**

Contamination inside refrigerant piping can cause deterioration of refrigerant oil, etc.

**Store the piping indoors, and both ends of the piping sealed until just before brazing. (Leave elbow joints, etc. in their packaging.)**

If dirt, dust or moisture enters into refrigerant cycle, that can cause deterioration of refrigerant oil or malfunction of compressor.

**The refrigerant oil applied to flare and flange connections must be ester oil, ether oil or alkylbenzene oil in a small amount.**

If large amount of mineral oil enters, that can cause deterioration of refrigerant oil, etc.

**Charge refrigerant from liquid phase of gas cylinder.**

If the refrigerant is charged from gas phase, composition change may occur in refrigerant and the efficiency will be lowered.

**Do not use refrigerant other than R410A.**

If other refrigerant (R22, etc.) is used, chlorine in refrigerant can cause deterioration of refrigerant oil, etc.

**Use a vacuum pump with a reverse flow check valve.**

Vacuum pump oil may flow back into refrigerant cycle and that can cause deterioration of refrigerant oil, etc.

**Use the following tools specifically designed for use with R410A refrigerant.**

The following tools are necessary to use R410A refrigerant.

Tools for R410A	
Gauge manifold	Flare tool
Charge hose	Size adjustment gauge
Gas leak detector	Vacuum pump adaptor
Torque wrench	Electronic refrigerant charging scale

**Handle tools with care.**

If dirt, dust or moisture enters into refrigerant cycle, that can cause deterioration of refrigerant oil or malfunction of compressor.

**Do not use a charging cylinder.**

If a charging cylinder is used, the composition of refrigerant will change and the efficiency will be lowered.

**Use the specified refrigerant only.**

**Never use any refrigerant other than that specified.**

Doing so may cause a burst, an explosion, or fire when the unit is being used, serviced, or disposed of. Correct refrigerant is specified in the manuals and on the spec labels provided with our products. We will not be held responsible for mechanical failure, system malfunction, unit breakdown or accidents caused by failure to follow the instructions.

**Ventilate the room if refrigerant leaks during operation. If refrigerant comes into contact with a flame, poisonous gases will be released.**

## [1] Cautions for service

- (1) Perform service after recovering the refrigerant left in unit completely.
- (2) Do not release refrigerant in the air.
- (3) After completing service, charge the cycle with specified amount of refrigerant.
- (4) When performing service, install a filter drier simultaneously.  
Be sure to use a filter drier for new refrigerant.

## [2] Additional refrigerant charge

**When charging directly from cylinder**

- Check that cylinder for R410A on the market is a syphon type.
- Charging should be performed with the cylinder of syphon stood vertically. (Refrigerant is charged from liquid phase.)

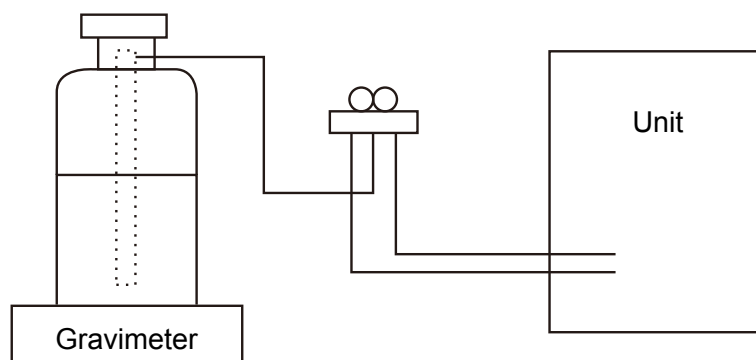

### [3] Service tools

Use the below service tools as exclusive tools for R410A refrigerant.

No.	Tool name	Specifications
①	Gauge manifold	<ul style="list-style-type: none"> <li>· Only for R410A</li> <li>· Use the existing fitting specifications. (UNF1/2)</li> <li>· Use high-tension side pressure of 5.3MPa·G or over.</li> </ul>
②	Charge hose	<ul style="list-style-type: none"> <li>· Only for R410A</li> <li>· Use pressure performance of 5.09MPa·G or over.</li> </ul>
③	Electronic scale	—
④	Gas leak detector	· Use the detector for R134a, R407C or R410A.
⑤	Adaptor for reverse flow check	· Attach on vacuum pump.
⑥	Refrigerant charge base	—
⑦	Refrigerant cylinder	<ul style="list-style-type: none"> <li>· Only for R410A</li> <li>· Top of cylinder (Pink)</li> <li>· Cylinder with syphon</li> </ul>
⑧	Refrigerant recovery equipment	—

## 2-3. PRECAUTIONS WHEN REUSING EXISTING R22 REFRIGERANT PIPES

### (1) Flowchart

- Refer to the flowchart below to determine if the existing pipes can be used and if it is necessary to use a filter drier.
- If the diameter of the existing pipes is different from the specified diameter, refer to technological data materials to confirm if the pipes can be used.

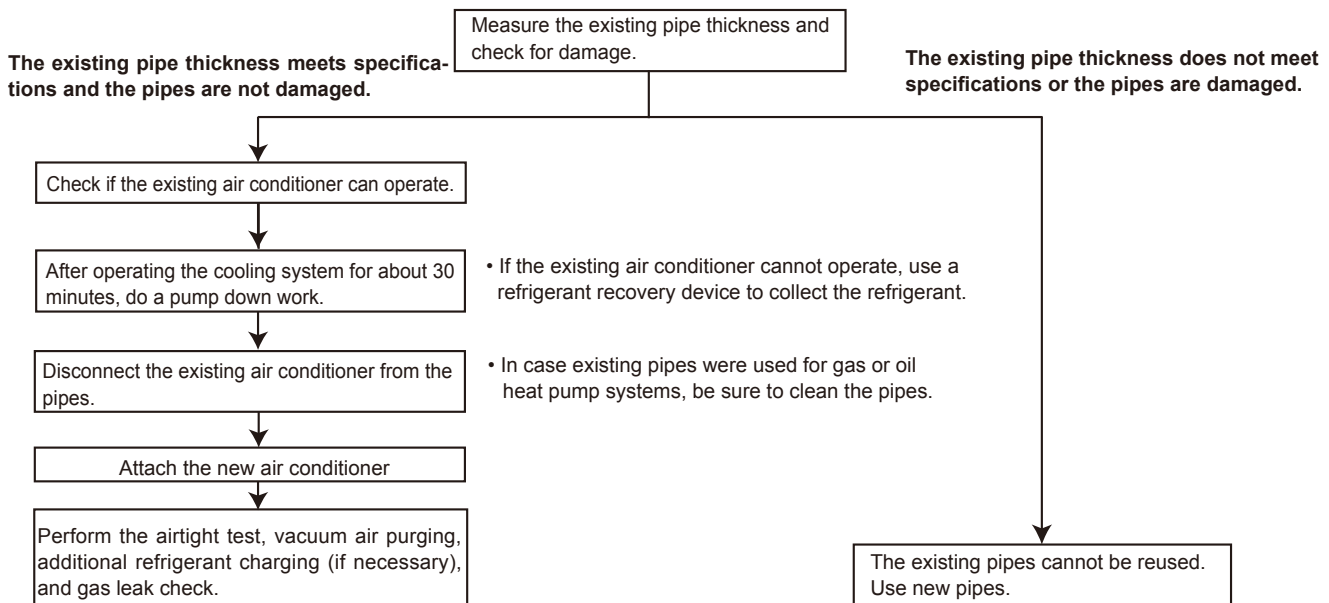

### (2) Cautions for refrigerant piping work

New refrigerant R410A is adopted for replacement inverter series. Although the refrigerant piping work for R410A is same as for R22, exclusive tools are necessary so as not to mix with different kind of refrigerant. Furthermore as the working pressure of R410A is 1.6 times higher than that of R22, their sizes of flared sections and flare nuts are different.

#### ① Thickness of pipes

Because the working pressure of R410A is higher compared to R22, be sure to use refrigerant piping with thickness shown below. (Never use pipes of 0.7 mm or below.)

Diagram below: Piping diameter and thickness

Nominal dimensions (in)	Outside diameter (mm)	Thickness (mm)	
		R410A	R22
1/4	6.35	0.8	0.8
3/8	9.52	0.8	0.8
1/2	12.70	0.8	0.8
5/8	15.88	1.0	1.0
3/4	19.05	—	1.0



② Dimensions of flare cutting and flare nut

The component molecules in HFC refrigerant are smaller compared to conventional refrigerants. In addition to that, R410A is a refrigerant, which has higher risk of leakage because its working pressure is higher than that of other refrigerants. Therefore, to enhance airtightness and strength, flare cutting dimension of copper pipe for R410A has been specified separately from the dimensions for other refrigerants as shown below. The dimension B of flare nut for R410A also has partly been changed to increase strength as shown below. Set copper pipe correctly referring to copper pipe flaring dimensions for R410A below. For 1/2 and 5/8 inch pipes, the dimension B changes. Use torque wrench corresponding to each dimension.

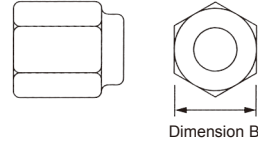
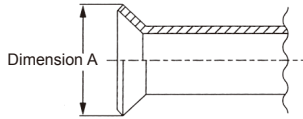

Flare cutting dimensions

Nominal dimensions (in)	Outside diameter (mm)	Dimension A ( $^{+0}_{-0.4}$ ) (mm)	
		R410A	R22
1/4	6.35	9.1	9.0
3/8	9.52	13.2	13.0
1/2	12.70	16.6	16.2
5/8	15.88	19.7	19.4
3/4	19.05	—	23.3

Flare nut dimensions

Nominal dimensions (in)	Outside diameter (mm)	Dimension B (mm)	
		R410A	R22
1/4	6.35	17.0	17.0
3/8	9.52	22.0	22.0
1/2	12.70	26.0	24.0
5/8	15.88	29.0*	27.0
3/4	19.05	—	36.0

③ Tools for R410A (The following table shows whether conventional tools can be used or not.)

Tools and materials	Use	R410A tools	Can R22 tools be used?	Can R407C tools be used?
Gauge manifold	Air purge, refrigerant charge and operation check	Tool exclusive for R410A	×	×
Charge hose		Tool exclusive for R410A	×	×
Gas leak detector	Gas leak check	Tool for HFC refrigerant	×	○
Refrigerant recovery equipment	Refrigerant recovery	Tool exclusive for R410A	×	×
Refrigerant cylinder	Refrigerant charge	Tool exclusive for R410A	×	×
Applied oil	Apply to flared section	Ester oil and alkylbenzene oil (minimum amount)	×	Ester oil: ○ Alkylbenzene oil: minimum amount
Safety charger	Prevent compressor malfunction when charging refrigerant by spraying liquid refrigerant	Tool exclusive for R410A	×	×
Charge valve	Prevent gas from blowing out when detaching charge hose	Tool exclusive for R410A	×	×
Vacuum pump	Vacuum drying and air purge	Tools for other refrigerants can be used if equipped with adapter for reverse flow check	△ (Usable if equipped with adapter for reverse flow)	△ (Usable if equipped with adapter for reverse flow)
Flare tool	Flaring work of piping	Tools for other refrigerants can be used by adjusting flaring dimension	△ (Usable by adjusting flaring dimension)	△ (Usable by adjusting flaring dimension)
Bender	Bend the pipes	Tools for other refrigerants can be used	○	○
Pipe cutter	Cut the pipes	Tools for other refrigerants can be used	○	○
Welder and nitrogen gas cylinder	Weld the pipes	Tools for other refrigerants can be used	○	○
Refrigerant charging scale	Refrigerant charge	Tools for other refrigerants can be used	○	○
Vacuum gauge or thermistor vacuum gauge and vacuum valve	Check the degree of vacuum. (Vacuum valve prevents back flow of oil and refrigerant to thermistor vacuum gauge)	Tools for other refrigerants can be used	○	○
Charging charge	Refrigerant charge	Tool exclusive for R410A	×	—

× : Prepare a new tool. (Use the new tool as the tool exclusive for R410A.)

△ : Tools for other refrigerants can be used under certain conditions.

○ : Tools for other refrigerants can be used.

## 2-4. PRECAUTIONS FOR SALT PROOF TYPE "-BS" MODEL

Although "-BS" model has been designed to be resistant to salt damage, observe the following precautions to maintain the performance of the unit.

1. Avoid installing the unit in a location where it will be exposed directly to seawater or sea breeze.
2. If the cover panel may become covered with salt, be sure to install the unit in a location where the salt will be washed away by rainwater. (If a sunshade is installed, rainwater may not clean the panel.)
3. To ensure that water does not collect in the base of the outdoor unit, make sure that the base is level, not at angle. Water collecting in the base of the outdoor unit could cause rust.
4. If the unit is installed in a coastal area, clean the unit with water regularly to remove any salt build-up.
5. If the unit is damaged during installation or maintenance, be sure to repair it.
6. Be sure to check the condition of the unit regularly.
7. Be sure to install the unit in a location with good drainage.

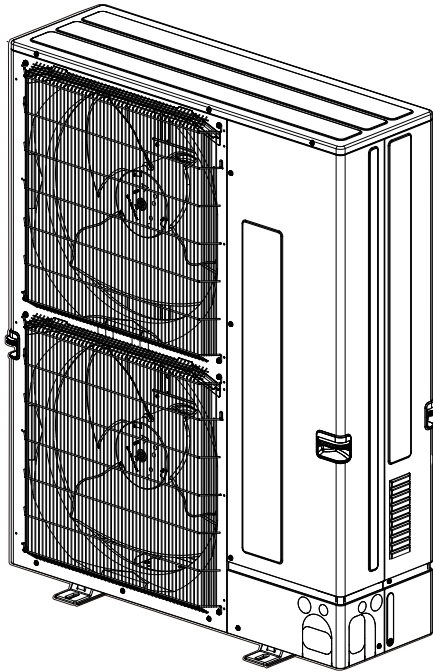

**PUHZ-SW160YKA**  
**PUHZ-SW200YKA**  
**PUHZ-SW160YKA-BS**  
**PUHZ-SW200YKA-BS**

### **CHARGELESS SYSTEM**

#### **PRE-CHARGED REFRIGERANT IS SUPPLIED FOR PIPING LENGTH AT SHIPMENT**

##### **Maximum 30 m**

The refrigerant circuit with LEV (Linear Expansion Valve) and power receiver/ accumulator always control the optimal refrigerant level regardless of the length (30 m maximum and 5 m minimum) of piping. The additional refrigerant charging work during installation often causes problems. It is completely eliminated by chargeless system. This unique system improves the quality and reliability of the work done. It also helps to speed up the installation time.

# 4

# SPECIFICATIONS

Service Ref.			PUHZ-SW160YKA(-BS).UK PUHZ-SW160YKAR1(-BS).UK	PUHZ-SW200YKA(-BS).UK PUHZ-SW200YKAR1(-BS).UK	
OUTDOOR UNIT	Power supply (phase, cycle, voltage)		3 phase 50Hz, 400V		
	Max. current	A	19	21	
	External finish		Munsell 3Y 7.8/1.1		
	Refrigerant control		Linear Expansion Valve		
	Compressor		Hermetic		
	Model		ANB52FRNMT		
	Motor output	kW	4.7	4.7	
	Starter type		Inverter		
	Protection devices		HP switch Comp. surface thermo HP sensor		
	Crankcase heater	W	—		
	Heat exchanger		Plate fin coil		
	Fan	Fan (drive) × No.		Propeller fan × 2	
		Fan motor output	kW	0.200 + 0.200	
		Airflow	m³/min(CFM)	140 (4,940)	
	Defrost method		Reverse cycle		
	Noise level (SPL)	Cooling	dB	58	60
		Heating	dB	62	62
	Dimensions	W	mm (in)	1,050 (41-5/16)	
		D	mm (in)	330 + 40 (13+1-9/16)	
		H	mm (in)	1,338 (52-11/16)	
Weight		kg (lb)	136 (299.88)		
Refrigerant			R410A		
Charge		kg (lb)	7.1 (15.7)	7.7 (17.0)	
	Oil (Model)	L	2.30 (FVC68D)		
Pipe size O.D.	Liquid	mm (in)	9.52 (3/8)	12.7 (1/2)	
	Gas	mm (in)	25.4 (1)	25.4 (1)	
Connection method	Indoor side		Flared		
	Outdoor side		Flared & Brazing		
Between the indoor & outdoor unit	Height difference		Maximum 30 m		
	Piping length		2 to 80 m		
REFRIGERANT PIPING					

## 5-1. ADJUSTING THE AMOUNT OF REFRIGERANT

Service Ref.	Permitted pipe length	Initial charge (kg)	Amount of additional refrigerant charge (kg)					
			30 m and less	31–40 m and less	41–50 m and less	51–60 m and less	61–70 m and less	
PUHZ-SW160YKA.UK PUHZ-SW160YKA-BS.UK PUHZ-SW160YKAR1.UK PUHZ-SW160YKAR1-BS.UK	80 m or less	7.1	No additional charge necessary	0.9 kg	1.8 kg	2.7 kg	3.6 kg	The additional charge amount is obtained by the following formula.
PUHZ-SW200YKA.UK PUHZ-SW200YKA-BS.UK PUHZ-SW200YKAR1.UK PUHZ-SW200YKAR1-BS.UK		7.7		1.2 kg	2.4 kg	3.6 kg	4.8 kg	

Calculate the additional charge amount based on the following procedure.

If the calculation results in an amount that is smaller than the "Additional charge amount for 70 m," perform the additional charge using the amount shown in "Additional charge amount for 70 m."

Amount of additional charge [kg]	=	Main piping: Liquid line size $\phi 12.7$ over all length [m] $\times 0.11$ [kg/m]	+	Main piping: Liquid line size $\phi 9.52$ overall length [m] $\times 0.09$ [kg/m]	+	Branch piping: Liquid line size $\phi 9.52$ overall length [m] $\times 0.06$ [kg/m]	+	Branch piping: Liquid line size $\phi 6.35$ overall length [m] $\times 0.02$ [kg/m]	-	3.6 (kg)
----------------------------------	---	---	---	--	---	--	---	--	---	----------

Additional charge amount for 70 m	SW160	3.6 kg
	SW200	4.8 kg

## 5-2. COMPRESSOR TECHNICAL DATA

(at 20°C)

Service Ref.	PUHZ-SW160/200YKA.UK PUHZ-SW160/200YKA-BS.UK PUHZ-SW160/200YKAR1.UK PUHZ-SW160/200YKAR1-BS.UK	
Compressor model	ANB52FRNMT	
Winding Resistance ( $\Omega$ )	U-V	0.30
	U-W	0.30
	W-V	0.30

### 5-3. NOISE CRITERION CURVES

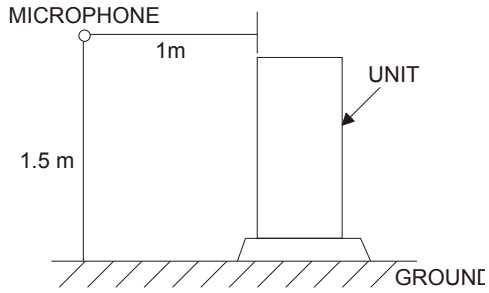

PUHZ-SW160YKA.UK  
 PUHZ-SW160YKA-BS.UK  
 PUHZ-SW160YKAR1.UK  
 PUHZ-SW160YKAR1-BS.UK

MODE	SPL(dB)	LINE
COOLING	58	○—○
HEATING	62	●—●

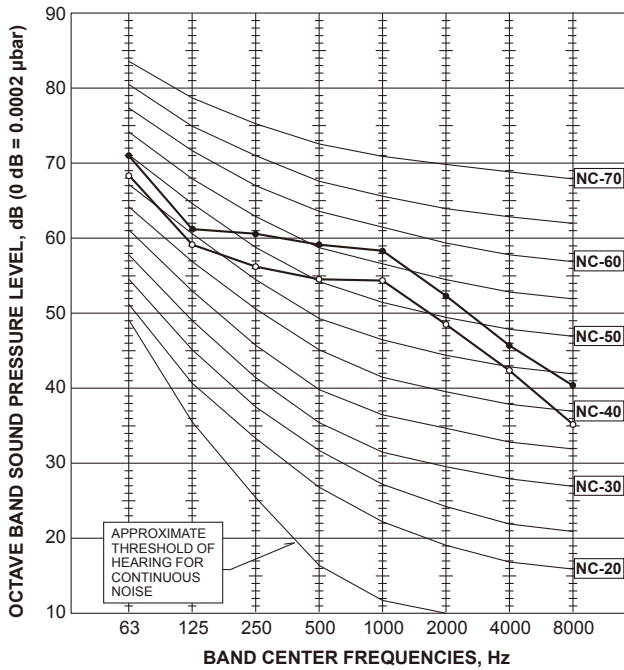

PUHZ-SW200YKA.UK  
 PUHZ-SW200YKA-BS.UK  
 PUHZ-SW200YKAR1.UK  
 PUHZ-SW200YKAR1-BS.UK

MODE	SPL(dB)	LINE
COOLING	60	○—○
HEATING	62	●—●

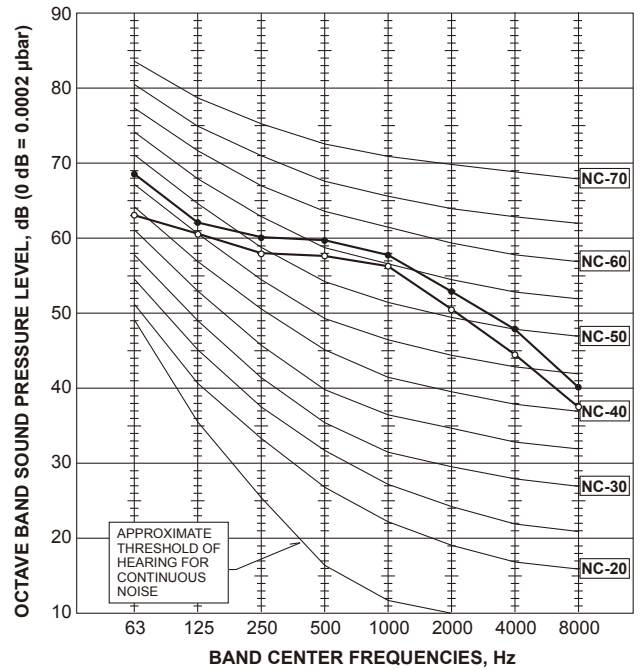

## 5-4. <REFERENCE DATA> PLATE HEAT EXCHANGER (ACH70-74 PLATES)

PUHZ-SW160YKA(-BS).UK  
PUHZ-SW160YKAR1(-BS).UK

PUHZ-SW200YKA(-BS).UK  
PUHZ-SW200YKAR1(-BS).UK

<b>Nominal water flow</b>		L/min	63.1
<b>Heating (A7/W35)</b>	Capacity	kW	22.0
	COP		4.20
	Power input	kW	5.238
<b>Heating (A7/W45)</b>	Capacity	kW	22.0
	COP		3.20
	Power input	kW	6.875
<b>Heating (A2/W35)</b>	Capacity	kW	16.0
	COP		3.11
	Power input	kW	5.144
<b>Heating (A2/W45)</b>	Capacity	kW	16.0
	COP		2.36
	Power input	kW	6.779
<b>Nominal water flow</b>		L/min	45.9
<b>Cooling (A35/W7)</b>	Capacity	kW	16.0
	EER		2.76
	Power input	kW	5.800
<b>Cooling (A35/W18)</b>	Capacity	kW	18.0
	EER		4.56
	Power input	kW	3.950

<b>Nominal water flow</b>		L/min	71.7
<b>Heating (A7/W35)</b>	Capacity	kW	25.0
	COP		4.00
	Power input	kW	6.250
<b>Heating (A7/W45)</b>	Capacity	kW	25.0
	COP		3.10
	Power input	kW	8.064
<b>Heating (A2/W35)</b>	Capacity	kW	20.0
	COP		2.80
	Power input	kW	7.142
<b>Heating (A2/W45)</b>	Capacity	kW	20.0
	COP		2.20
	Power input	kW	9.090
<b>Nominal water flow</b>		L/min	57.3
<b>Cooling (A35/W7)</b>	Capacity	kW	20.0
	EER		2.25
	Power input	kW	8.888
<b>Cooling (A35/W18)</b>	Capacity	kW	22.0
	EER		4.10
	Power input	kW	5.365

Note: "COP" and "Power input" in the above table do **NOT** contain the "pump input (based on EN 14511)".

### Rating conditions

Nominal operating condition	
<b>Heating (A7/W35)</b>	
Outside air temperature (Dry-bulb)	+ 7°C
Outside air temperature (Wet-bulb)	+ 6°C
Water temperature (inlet/outlet)	+ 30°C/+ 35°C
<b>Heating (A7/W45)</b>	
Outside air temperature (Dry-bulb)	+ 7°C
Outside air temperature (Wet-bulb)	+ 6°C
Water temperature (inlet/outlet)	+ 40°C/+ 45°C
<b>Heating (A2/W35)</b>	
Outside air temperature (Dry-bulb)	+ 2°C
Outside air temperature (Wet-bulb)	+ 1°C
Water temperature (inlet/outlet)	+ 30°C/+ 35°C
<b>Heating (A2/W45)</b>	
Outside air temperature (Dry-bulb)	+ 2°C
Outside air temperature (Wet-bulb)	+ 1°C
Water temperature (inlet/outlet)	+ 40°C/+ 45°C
<b>Cooling (A35/W7)</b>	
Outside air temperature (Dry-bulb)	+ 35°C
Outside air temperature (Wet-bulb)	+ 24°C
Water temperature (inlet/outlet)	+ 12°C/+ 7°C
<b>Cooling (A35/W18)</b>	
Outside air temperature (Dry-bulb)	+ 35°C
Outside air temperature (Wet-bulb)	+ 24°C
Water temperature (inlet/outlet)	+ 23°C/+ 18°C

PUHZ-SW160YKA.UK  
 PUHZ-SW160YKA-BS.UK  
 PUHZ-SW160YKAR1.UK  
 PUHZ-SW160YKAR1-BS.UK

PUHZ-SW200YKA.UK  
 PUHZ-SW200YKA-BS.UK  
 PUHZ-SW200YKAR1.UK  
 PUHZ-SW200YKAR1-BS.UK

Unit: mm

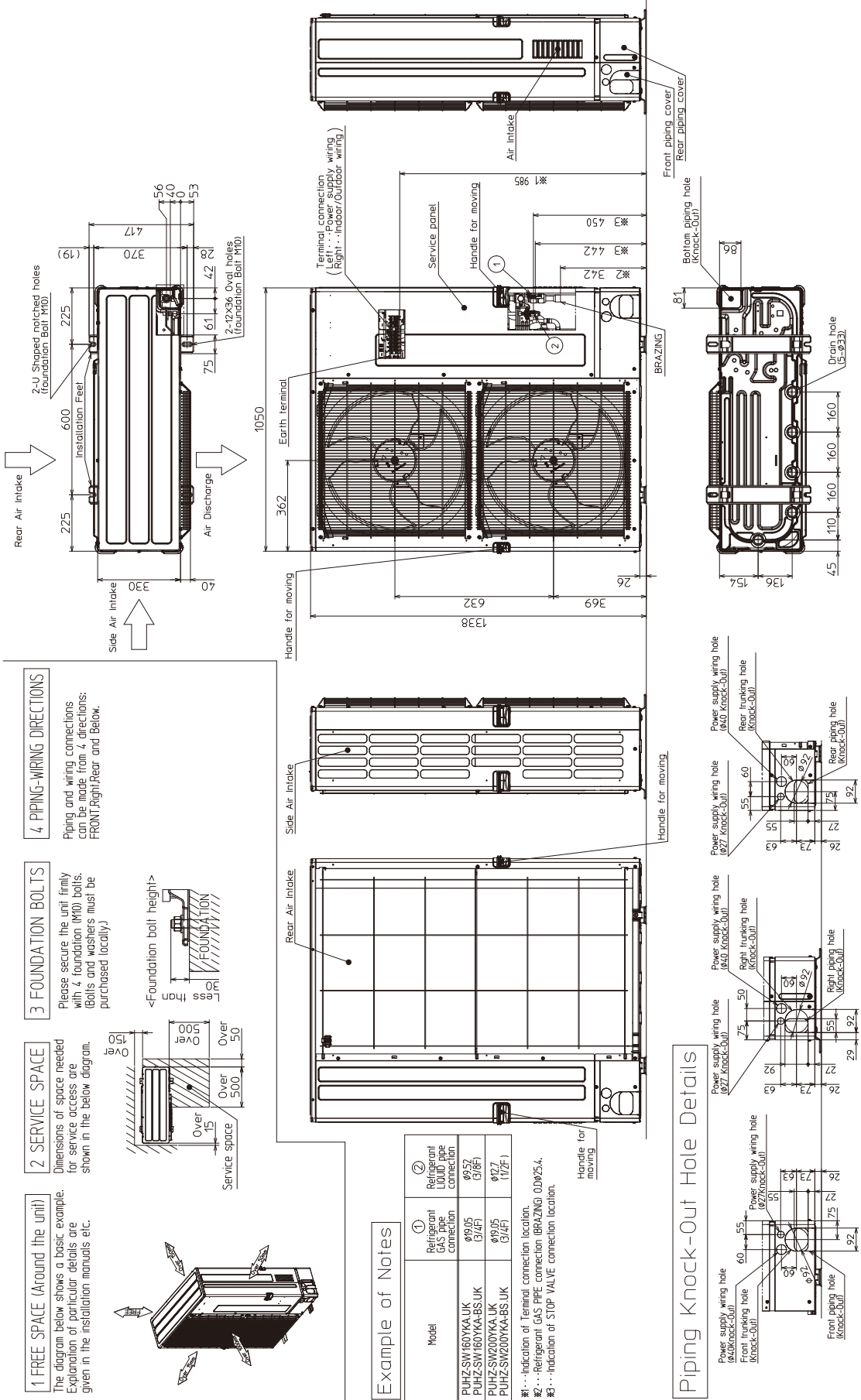

4 PIPING-WIRING DIRECTIONS

Piping and wiring connections can be made from 4 directions: FRONT, RIGHT, REAR and BELOW.

3 FOUNDATION BOLTS

Please secure the unit firmly with 4 foundation (M10) bolts. (Bolts and washers must be purchased locally).

2 SERVICE SPACE

Dimensions of space needed for service access are shown in the below diagram.

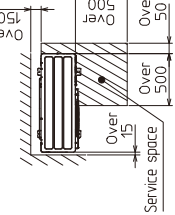

1 FREE SPACE (Around the unit)

The diagram below shows a basic example. Explanation of particular details are given in the installation manuals etc.

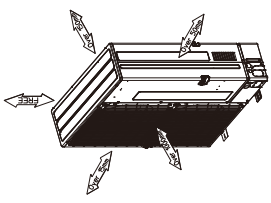

Example of Notes

Model	① Refrigerant GAS pipe connection	② Refrigerant LIQUID pipe connection
PUHZ-SW160YKA.UK	φ9.05 (3/4F)	φ6.52 (3/8F)
PUHZ-SW160YKA-BS.UK	φ9.05 (3/4F)	φ6.52 (3/8F)
PUHZ-SW200YKA.UK	φ9.05 (3/4F)	φ7.27 (1/2F)
PUHZ-SW200YKA-BS.UK	φ9.05 (3/4F)	φ7.27 (1/2F)

※1:.. Indication of Terminal connection location.  
 ※2:.. Refrigerant GAS PIPE connection (BRAZING) 0.09φ25.4.  
 ※3:.. Indication of STOP VALVE connection location.



PUHZ-SW160YKA.UK  
 PUHZ-SW160YKA-BS.UK  
 PUHZ-SW160YKAR1.UK  
 PUHZ-SW160YKAR1-BS.UK

PUHZ-SW200YKA.UK  
 PUHZ-SW200YKA-BS.UK  
 PUHZ-SW200YKAR1.UK  
 PUHZ-SW200YKAR1-BS.UK

SYMBOL	NAME	SYMBOL	NAME	SYMBOL	NAME
TB1	Terminal Block <Power Supply>	CY1, CY2	Capacitor	SW8	Switch <Function Switch>
TB2	Terminal Block <Indoor/Outdoor>	P.B.	Power Circuit Board	SW9	Switch <Function Switch>
MC	Motor for Compressor	TB-U/V/W	Connection Terminal <U/V/W-Phase>	SWP	Switch <Pump Down>
MF1, MF2	Fan Motor	TB-L1/L2/L3	Connection Terminal <L1/L2/L3-Power Supply>	CN31	Connector <Emergency Operation>
21S4	Solenoid Valve (Four-Way Valve)	TB-P1/P3	Connection Terminal	CN3S	Connector <Connection for Option>
63H	High Pressure Switch	X52CA/B	52C Relay	CNDM	Connector <Connection for Option>
63HS	High Pressure Sensor	N.F.	Noise Filter Circuit Board	CN51	Connector <Connection for Option>
TH3	Thermistor <Liquid>	L1/L12/L13/N1	Connection Terminal <L1/L2/L3/N-Power Supply>	SV1	Connector <Connection for Option>
TH6	Thermistor <2-Phase Pipe>	LO1/LO2/LO3	Connection Terminal <L1/L2/L3-Power Supply>	SS	Connector <Connection for Option>
TH7	Thermistor <Ambient>	GD1, GD2	Connection Terminal <Ground>	CNM	Connector <Connection for Option>
TH8	Thermistor <Heat Sink>	C.B.	Controller Circuit Board	LED1, LED2	LED <Operation Inspection Indicators>
TH32	Thermistor <Comp. Surface>	SW1	Switch <Manual Defrost, Defect History, Record Reset, Refrigerant Address>	F3, F4	Fuse <T6.3AL250V>
LEV-A	Linear Expansion Valve	SW4	Switch <Test Operation>	X51, X52, X54	Relay
ACL4	Reactor	SW5	Switch <Function Switch, Model Select>		
DCL	Reactor	SW6	Switch <Function Switch, Model Select>		
RS	Rush Current Protect Resistor	SW7	Switch <Function Switch>		
FUSE1, FUSE2	Fuse <T15AL250V>				

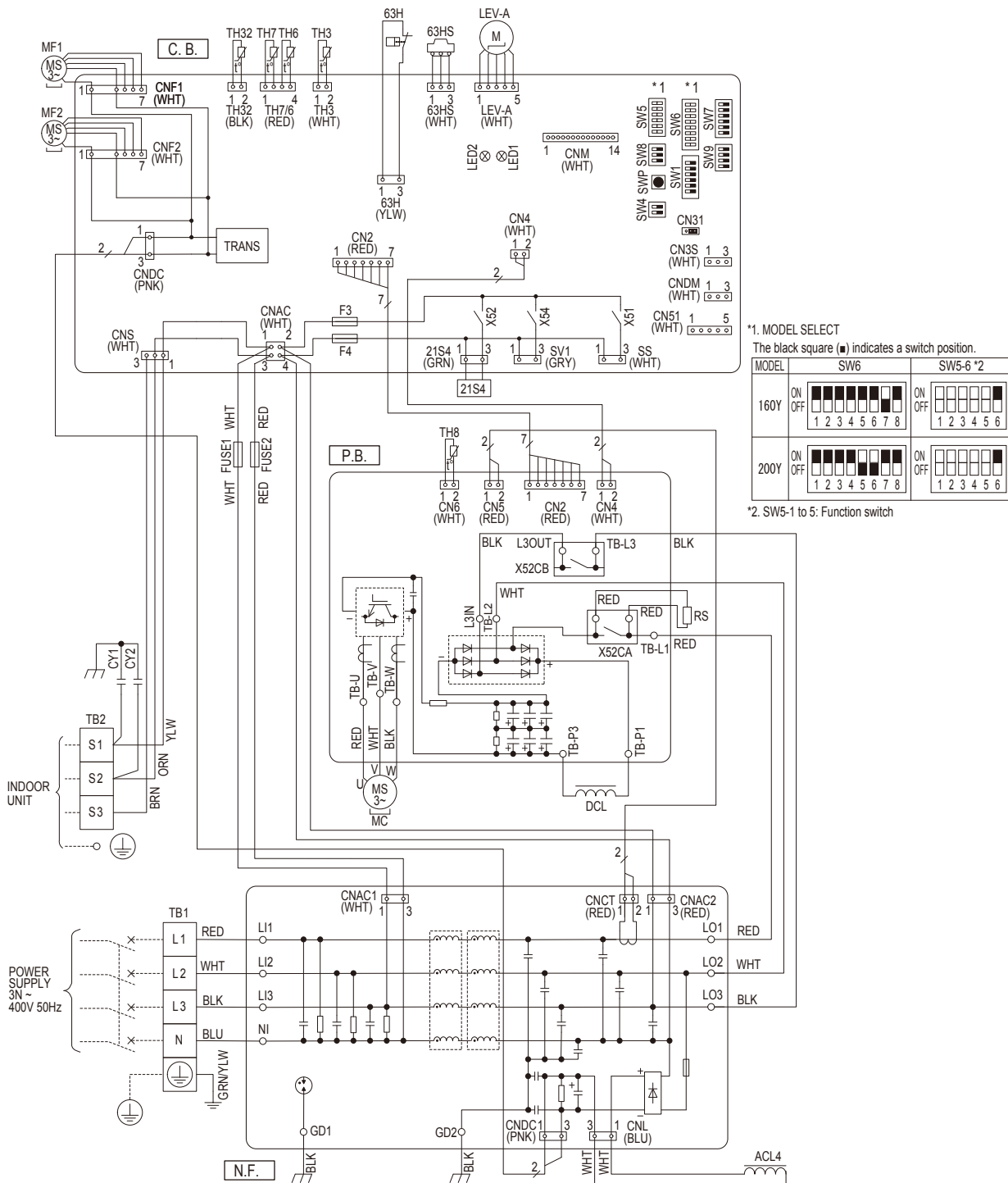

## 8-1. FIELD ELECTRICAL WIRING (power wiring specifications)

Outdoor unit model	SW160/200	
Outdoor unit power supply	3N~ (3 ph 4-wires), 50 Hz, 400 V	
Outdoor unit input capacity main switch (Breaker) *1	32 A	
Outdoor unit power supply	5 × Min. 4	
Wiring Wire No. x size (mm <sup>2</sup> )	Indoor unit-Outdoor unit *2	Cable length 50m: 3×4 (Polar)/ Cable length 80m: 3×6 (Polar)
	Indoor unit-Outdoor unit earth *2	1 × Min. 2.5
	Remote controller-Indoor unit *3	2 × 0.3 (Non-polar)
Circuit rating	Outdoor unit L-N (single)	230 V AC
	Outdoor unit L1-N, L2-N, L3-N (3 phase)	230 V AC
	Indoor unit-Outdoor unit S1-S2 *4	230 V AC
	Indoor unit-Outdoor unit S2-S3 *4	24 V DC
	Remote controller-Indoor unit *4	12 V DC

\*1. A breaker with at least 3.0 mm contact separation in each pole shall be provided. Use earth leakage breaker (NV).

Make sure that the current leakage breaker is one compatible with higher harmonics.

Always use a current leakage breaker that is compatible with higher harmonics as this unit is equipped with an inverter.

The use of an inadequate breaker can cause the incorrect operation of inverter.

\*2. Maximum 80 m. Total maximum including all indoor/outdoor connection is 80 m.

\* Use one cable for S1 and S2, and another for S3 as shown in the picture.

\*3. The 10 m wire is attached in the remote controller accessory.

\*4. The figures are NOT always against the ground.

S3 terminal has 24 V DC against S2 terminal. However between S3 and S1, these terminals are NOT electrically insulated by the transformer or other device.



**⚠ Caution: Be sure to install N-Line. Without N-Line, it could cause damage to the unit.**

**Notes:** 1. Wiring size must comply with the applicable local and national codes.

2. Power supply cables and the cables between indoor and outdoor unit shall not be lighter than polychloroprene sheathed flexible cables. (Design 60245 IEC 57)

3. Be sure to connect the cables between indoor and outdoor unit directly to the units (no intermediate connections are allowed).

Intermediate connections may result in communication errors. If water enters at the intermediate connection point, it may cause insufficient insulation to ground or a poor electrical contact.

(If an intermediate connection is necessary, be sure to take measures to prevent water from entering the cables.)

4. Install an earth longer than other cables.

5. Do not construct a system with a power supply that is turned ON and OFF frequently.

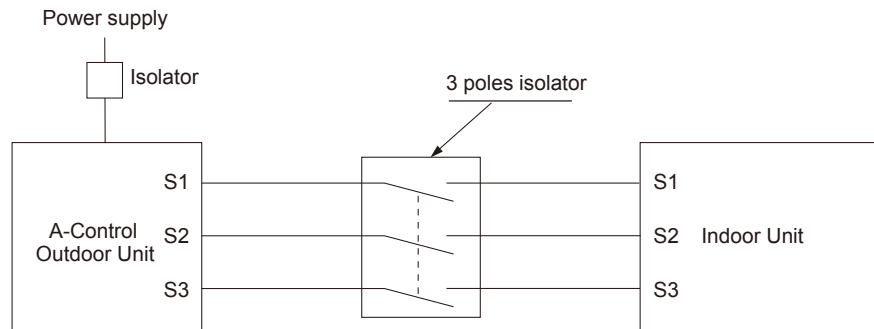

**⚠ Warning:**

In case of A-control wiring, there is high voltage potential on the S3 terminal caused by electrical circuit design that has no electrical insulation between power line and communication signal line. Therefore, please turn off the main power supply when servicing. And do not touch the S1, S2, S3 terminals when the power is energized. If isolator should be used between indoor unit and outdoor unit, please use 3-pole type.

## 8-2. INDOOR – OUTDOOR CONNECTING CABLE

The cable shall not be lighter than design 60245 IEC or 60227 IEC.





Outdoor power supply	Wire No. × Size (mm <sup>2</sup> )		
	Max. 45 m	Max. 50 m	Max. 80 m
Indoor unit-Outdoor unit	3 × 1.5 (polar)	3 × 2.5 (polar)	3 × 2.5 (polar) and S3 separated
Indoor unit-Outdoor unit earth	1 × Min. 1.5	1 × Min. 2.5	1 × Min. 2.5

Note: The Max. cable length may vary depending on the condition of installation, humidity or materials, etc.

Indoor/Outdoor separate power supply	Wire No. × Size (mm <sup>2</sup> )
	Max. 120 m
Indoor unit-Outdoor unit	2 × Min. 0.3
Indoor unit-Outdoor unit earth	—

Note: The optional indoor power supply terminal kit is necessary.

Be sure to connect the indoor-outdoor connecting cables directly to the units (no intermediate connections). Intermediate connections can lead to communication errors if water enters the cables and causes insufficient insulation to ground or a poor electrical contact at the intermediate connection point.

Cross section of cable	Wire size (mm <sup>2</sup> )	Number of wires	Polarity	L (m) <sup>*5</sup>
Round 	2.5	3	Clockwise : S1-S2-S3 (Pay attention to stripe of yellow and green.)	(30) <sup>*1</sup>
Flat 	2.5	3	Not applicable (since center wire has no cover finish.)	Not applicable <sup>*4</sup>
Flat 	1.5	4	From left to right : S1-Open-S2-S3	(18) <sup>*2</sup>
Round 	2.5	4	Clockwise : S1-S2-S3-Open (Connect S1 and S3 to the opposite angle.)	(30) <sup>*3</sup>

Note: Power supply cords of appliances shall not be lighter than design 60245 IEC or 227 IEC.

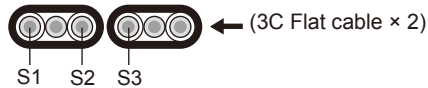

<sup>\*1</sup> In case that cable with stripe of yellow and green is available.

<sup>\*2</sup> In case of regular polarity connection (S1-S2-S3), wire size is 1.5 mm<sup>2</sup>.

<sup>\*3</sup> In case of regular polarity connection (S1-S2-S3).

<sup>\*4</sup> In the flat cables are connected as this picture, they can be used up to 30 m.

<sup>\*5</sup> Mentioned cable length is just a reference value.

It may be different depending on the condition of installation, humidity or materials, etc.

9-1. REFRIGERANT SYSTEM DIAGRAM

PUHZ-SW160YKA.UK

PUHZ-SW160YKA-BS.UK

PUHZ-SW160YKAR1.UK

PUHZ-SW160YKAR1-BS.UK

PUHZ-SW200YKA.UK

PUHZ-SW200YKA-BS.UK

PUHZ-SW200YKAR1.UK

PUHZ-SW200YKAR1-BS.UK

Unit: mm (in)

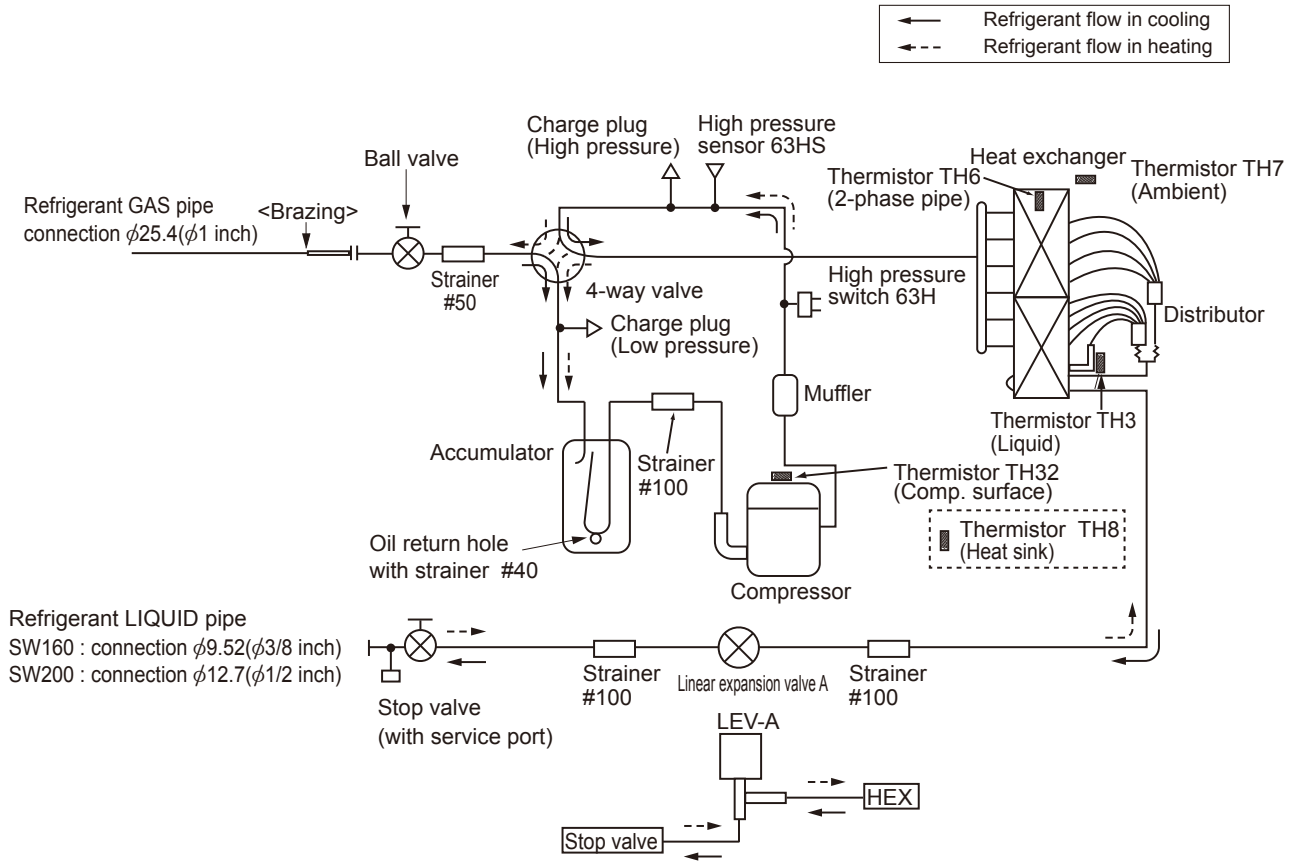

## 9-2. REFRIGERANT COLLECTING (PUMP DOWN)

When relocating or disposing of the indoor/outdoor unit, pump down the system following the procedure below so that no refrigerant is released into the atmosphere.

- ① Turn off the power supply (circuit breaker).
- ② Connect the low-pressure valve on the gauge manifold to the charge plug (low pressure side) on the outdoor unit.
- ③ Close the liquid stop valve completely.
- ④ Supply power (circuit breaker).
  - When power is supplied, make sure that “CENTRALLY CONTROLLED” is not displayed on the remote controller. If “CENTRALLY CONTROLLED” is displayed, the refrigerant collecting (pump down) cannot be completed normally.
  - Startup of the indoor-outdoor communication takes about 3 minutes after the power (circuit breaker) is turned on. Start the pump-down operation 3 to 4 minutes after the power (circuit breaker) is turned on.
- ⑤ Perform the refrigerant collecting operation (cooling test run).
  - Push the pump-down SWP switch (push-button type) on the control board of the outdoor unit. The compressor and ventilators (indoor and outdoor units) start operating (refrigerant collecting operation begins). (LED1 and LED2 on the control board of the outdoor unit are lit.)
  - Only push the pump-down SWP switch if the unit is stopped. However, even if the unit is stopped and the pump-down SWP switch is pushed less than 3 minutes after the compressor stops, the refrigerant collecting operation cannot be performed. Wait until the compressor has been stopped for 3 minutes and then push the pump-down SWP switch again.
- ⑥ Fully close the ball valve on the gas pipe side of the outdoor unit when the pressure gauge on the gauge manifold shows 0.05 to 0 MPa [Gauge] (approx. 0.5 to 0 kgf/cm<sup>2</sup>) and quickly stop the air conditioner.
  - Because the unit automatically stops in about 3 minutes when the refrigerant collecting operation is completed (LED1 off, LED2 lit), be sure to quickly close the gas ball valve. However, if LED1 is lit, LED2 is off, and the unit is stopped, open the liquid stop valve completely, close the valve completely after 3 minutes or more have passed, and then repeat step ⑤. (Open the gas ball valve completely.)
  - If the refrigerant collecting operation has been completed normally (LED1 off, LED2 lit), the unit will remain stopped until the power supply is turned off.
  - Note that when the extension piping is very long with a large refrigerant amount, it may not be possible to perform a pump down operation. In this case, use refrigerant recovery equipment to collect all of the refrigerant in the system.
- ⑦ Turn off the power supply (circuit breaker), remove the gauge manifold, and then disconnect the refrigerant pipes.

### ⚠ Warning:

**When pumping down the refrigerant, stop the compressor before disconnecting the refrigerant pipes.**

- **If the refrigerant pipes are disconnected while the compressor is operating and the stop valve (ball valve) is open, the pressure in the refrigeration cycle could become extremely high if air is drawn in, causing the pipes to burst, personal injury, etc.**

**Note:** This section is applicable only for PAC-IF061/062B-E/PAC-SIF051B-E or later models.

### 10-1. TROUBLESHOOTING

#### <Check code displayed by self-diagnosis and actions to be taken for service (summary)>

Present and past check codes are logged, and they can be displayed on the wired remote controller and control board of outdoor unit. Actions to be taken for service, which depends on whether or not the trouble is reoccurring in the field, are summarized in the table below. Check the contents below before investigating details.

Unit conditions at service	Check code	Actions to be taken for service (summary)
The trouble is reoccurring.	Displayed	Judge what is wrong and take a corrective action according to "10-2. SELF-DIAGNOSIS ACTION TABLE".
	Not displayed	Conduct trouble shooting and ascertain the cause of the trouble according to "10-3. TROUBLESHOOTING OF PROBLEMS".
The trouble is not reoccurring.	Logged	<ul style="list-style-type: none"> <li>①Consider the temporary defects such as the work of protection devices in the refrigerant circuit including compressor, poor connection of wiring, noise, etc. Re-check the symptom, and check the installation environment, refrigerant amount, weather when the trouble occurred, matters related to wiring, etc.</li> <li>②Reset check code logs and restart the unit after finishing service.</li> <li>③There is no abnormality in electrical component, controller board, remote controller, etc.</li> </ul>
	Not logged	<ul style="list-style-type: none"> <li>①Re-check the abnormal symptom.</li> <li>②Conduct trouble shooting and ascertain the cause of the trouble according to "10-3. TROUBLESHOOTING OF PROBLEMS".</li> <li>③Continue to operate unit for the time being if the cause is not ascertained.</li> <li>④There is no abnormality concerning of parts such as electrical component, controller board, remote controller, etc.</li> </ul>

## 10-2. SELF-DIAGNOSIS ACTION TABLE

<Abnormalities detected when the power is put on>

Note: Refer to indoor unit section for codes starting with P and E.

Check Code	Abnormal points and detection method	Case	Judgment and action
None	—	<p>① No voltage is supplied to terminal block (TB1) of outdoor unit. a) Power supply breaker is turned off. b) Contact failure or disconnection of power supply terminal c) Open phase (L2 or N phase)</p> <p>② Electric power is not supplied to power supply terminal of outdoor power circuit board. a) Contact failure of power supply terminal b) Open phase on the outdoor power circuit board (Disconnection of terminal on outdoor power circuit board)</p> <p>③ Electric power is not supplied to outdoor controller circuit board. a) Disconnection of connector (CNDC)</p> <p>④ Disconnection of reactor (ACL4)</p> <p>⑤ Disconnection of outdoor noise filter circuit board or parts failure in outdoor noise filter circuit board</p> <p>⑥ Defective outdoor power circuit board</p> <p>⑦ Open of rush current protect resistor (RS)</p> <p>⑧ Defective outdoor controller circuit board</p>	<p>① Check following items. a) Power supply breaker b) Connection of power supply terminal block (TB1) c) Connection of power supply terminal block (TB1)</p> <p>② Check following items. a) Connection of power supply terminal block (TB1) b) Connection of terminal on outdoor power circuit board</p> <p>③ Check connection of the connector (CNDC) on the outdoor controller circuit board. Check connection of the connector CNDC on the noise filter circuit board. Refer to "10-6. TEST POINT DIAGRAM".</p> <p>④ Check connection of reactor. (ACL4) Refer to "8. WIRING DIAGRAM".</p> <p>⑤ a) Check connection of outdoor noise filter circuit board. b) Replace outdoor noise filter circuit board. Refer to "10-6. TEST POINT DIAGRAM".</p> <p>⑥ Replace outdoor power circuit board.</p> <p>⑦ Replace rush current protect resistor (RS) Power circuit board might be short-circuit. Check the power circuit board. (Refer to "10-6. TEST POINT DIAGRAM".)</p> <p>⑧ Replace controller board. (When items above are checked but the units cannot be repaired.)</p>
F5 (5201)	<p><b>63H connector open</b> Abnormal if 63H connector circuit is open for 3 minutes continuously after power supply. 63H: High-pressure switch</p>	<p>① Disconnection or contact failure of 63H connector on outdoor controller circuit board</p> <p>② Disconnection or contact failure of 63H</p> <p>③ 63H is working due to defective parts.</p> <p>④ Defective outdoor controller circuit board</p>	<p>① Check connection of 63H connector on outdoor controller circuit board. Refer to "10-6. TEST POINT DIAGRAM".</p> <p>② Check the 63H side of connecting wire.</p> <p>③ Check continuity by tester. Replace the parts if the parts are defective.</p> <p>④ Replace outdoor controller circuit board.</p>



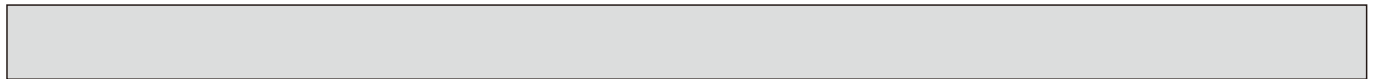

Check Code	Abnormal points and detection method	Case	Judgment and action
EA (6844)	<p><b>Miswiring of indoor/outdoor unit connecting wire</b></p> <p>1. Outdoor controller circuit board can automatically check the number of connected indoor units. Abnormal if the number cannot be checked automatically due to miswiring of indoor/outdoor unit connecting wire, etc. after power is turned on for 4 minutes.</p> <p>2. Abnormal if outdoor controller circuit board recognizes excessive number of indoor units.</p>	<p>① Contact failure or miswiring of indoor/outdoor unit connecting wire</p> <p>② Diameter or length of indoor/outdoor unit connecting wire is out of specified capacity.</p> <p>③ Excessive number of indoor units are connected to 1 outdoor unit.</p> <p>④ Defective transmitting receiving circuit of outdoor controller circuit board</p> <p>⑤ Defective transmitting receiving circuit of indoor controller board</p> <p>⑥ Defective indoor power board</p> <p>⑦ 2 or more outdoor units have refrigerant address "0" . (In case of group control)</p> <p>⑧ Noise has entered into power supply or indoor / outdoor unit connecting wire.</p>	<p>① Check disconnection or looseness or polarity of indoor/outdoor unit connecting wire of indoor and outdoor units.</p> <p>② Check diameter and length of indoor/outdoor unit connecting wire. Total wiring length: 80 m (including wiring connecting each indoor unit and between indoor and outdoor unit) Also check if the connection order of flat cable is S1, S2, S3.</p> <p>③ Check the number of indoor units that are connected to one outdoor unit. (If EA is detected)</p> <p>④–⑥ Turn the power off once, and on again to check. Replace outdoor controller circuit board, indoor controller board or indoor power board if abnormality occurs again.</p> <p>⑦ Check if refrigerant addresses (SW1-3 to SW1-6 on outdoor controller circuit board) are overlapping in case of group control system.</p>
Eb (6845)	<p><b>Miswiring of indoor/outdoor unit connecting wire (converse wiring or disconnection)</b></p> <p>Outdoor controller circuit board can automatically set the unit number of indoor units. Abnormal if the indoor unit number cannot be set within 4 minutes after power on because of miswiring (converse wiring or disconnection) of indoor/outdoor unit connecting wire.</p>	<p>① Contact failure or miswiring of indoor/outdoor unit connecting wire</p> <p>② Diameter or length of indoor/outdoor unit connecting wire is out of specified capacity.</p> <p>④ Defective transmitting receiving circuit of outdoor controller circuit board</p> <p>⑤ Defective transmitting receiving circuit of indoor controller board</p> <p>⑥ Defective indoor power board</p> <p>⑦ 2 or more outdoor units have refrigerant address "0" . (In case of group control)</p> <p>⑧ Noise has entered into power supply or indoor/outdoor unit connecting wire.</p>	<p>⑧ Check transmission path, and remove the cause.</p> <p>Note: The descriptions above ①–⑧, are for EA, Eb and EC.</p>
EC (6846)	<p><b>Startup time over</b></p> <p>The unit cannot finish startup process within 4 minutes after power on.</p>	<p>① Contact failure of indoor/outdoor unit connecting wire</p> <p>② Diameter or length of indoor/outdoor unit connecting wire is out of specified capacity.</p> <p>⑦ 2 or more outdoor units have refrigerant address "0" . (In case of group control)</p> <p>⑧ Noise has entered into power supply or indoor/outdoor unit connecting wire.</p>	

<Abnormalities detected while unit is operating>

Check Code	Abnormal points and detection method	Case	Judgment and action
U1 (1302)	<p><b>High pressure (High-pressure switch 63H operated)</b> Abnormal if high-pressure switch 63H (4.15MPa) operated during compressor operation.</p>	<p>① Decreased water flow ② Clogged filter of water pipe ③ Locked water pump ④ Malfunction of water pump ⑤ Dirt of indoor heat exchanger ⑥ Defective operation of stop valve (Not full open) ⑦ Clogged or broken pipe ⑧ Locked outdoor fan motor ⑨ Malfunction of outdoor fan motor ⑩ Short cycle of outdoor unit ⑪ Dirt of outdoor heat exchanger ⑫ Decreased airflow caused by defective inspection of outside temperature thermistor (It detects lower temperature than actual temperature.) ⑬ Disconnection or contact failure of connector (63H) on outdoor controller board ⑭ Disconnection or contact failure of 63H connection ⑮ Defective outdoor controller board ⑯ Defective action of linear expansion valve ⑰ Malfunction of fan driving circuit</p>	<p>①-⑤ Check water circuit and repair defect.  ⑥ Check if stop valve is fully open.  ⑦ Check piping and repair defect. ⑧-⑪ Check outdoor unit and repair defect.  ⑫ Check the detected temperature of outside temperature thermistor on LED display. (SW2 on A-Control Service Tool : Refer to "10-7. FUNCTION OF SWITCHES, CONNECTORS AND JUMPERS".) ⑬-⑮ Turn the power off and check if F5 is displayed when the power is turned on again. When F5 is displayed, refer to "Judgment and action" for F5.  ⑯ Check linear expansion valve. Refer to "10-4. HOW TO CHECK THE PARTS". ⑰ Replace outdoor controller board.</p>
U2 (TH32:1132)	<p><b>High comp. surface temperature</b> (1) Abnormal if comp. surface thermistor (TH32) exceeds 125°C or 115°C continuously for 5 minutes. Abnormal if comp. surface thermistor (TH32) exceeds 110°C or more continuously for 30 seconds after 90 seconds have passed since the defrosting operation started. (2) Abnormal if discharge superheat (Cooling: TH32-T<sub>63HS</sub> Heating: TH32-T<sub>63HS</sub>) increases. All the conditions in A or B are detected simultaneously for 10 minutes continuously after 6 minutes past from compressor startup (including the thermostat indication or recovery from defrosting). &lt;Condition A&gt; • Heating mode • When discharge superheat is less than 70°C. • When the TH6 temp is more than the value obtained by TH7-5°C. • When the condensing temp of TH5 is less than 35°C. &lt;Condition B&gt; • During compressor operation (Cooling and Heating) • When discharge superheat is less than 80°C in Cooling. • When discharge superheat is less than 90°C in Heating. • When condensing temp of TH6 is more than -40°C. (In Cooling only.)</p>	<p>① Overheated compressor operation caused by shortage of refrigerant ② Defective operation of stop valve ③ Defective thermistor ④ Defective outdoor controller board ⑤ Defective action of linear expansion valve</p>	<p>① Check intake superheat. Check leakage of refrigerant. Charge additional refrigerant. ② Check if stop valve is fully open. ③④ Turn the power off and check if U3 is displayed when the power is on again. When U3 is displayed, refer to "Judgment and action" for U3. ⑤ Check linear expansion valve. Refer to "10-4. HOW TO CHECK THE PARTS".</p>
U3 (TH32:5132)	<p><b>Open/short circuit of comp. surface thermistor (TH32)</b> Abnormal if open (-20°C or less) or short (217°C or more) is detected during compressor operation. (Detection is inoperative for 10 minutes of compressor starting process and for 10 minutes after and during defrosting.)</p>	<p>① Disconnection or contact failure of connector (TH32) on the outdoor controller circuit board ② Defective thermistor ③ Defective outdoor controller circuit board</p>	<p>① Check connection of connector (TH32) on the outdoor controller circuit board. Check breaking of the lead wire for thermistor TH32. Refer to "10-6. TEST POINT DIAGRAM". ② Check resistance value of thermistor (TH32) or temperature by microprocessor.(Thermistor/TH32: Refer to "10-4. HOW TO CHECK THE PARTS".)(SW2 on A-Control Service Tool: Refer to "10-7. FUNCTION OF SWITCHES, CONNECTORS AND JUMPERS".) ③ Replace outdoor controller board.</p>

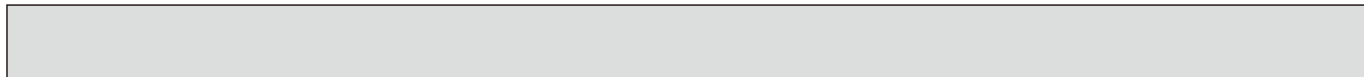

Check Code	Abnormal points and detection method	Case	Judgment and action																					
U4 (TH3:5105) (TH6:5107) (TH7:5106) (TH8:5110)	<b>Open/short of outdoor unit thermistors (TH3, TH6, TH7, and TH8)</b> Abnormal if open or short is detected during compressor operation. Open detection of thermistors TH3 and TH6 is inoperative for 10 seconds to 10 minutes after compressor starting and 10 minutes after and during defrosting. Note: Check which unit has abnormality in its thermistor by switching the mode of SW2. (PAC-SK52ST) (Refer to "10-7. FUNCTION OF SWITCHES, CONNECTORS AND JUMPERS".)	① Disconnection or contact failure of connectors ( Outdoor controller circuit board: TH3, TH6/TH7 Outdoor power circuit board: CN3 ) ② Defective thermistor ③ Defective outdoor controller circuit board	① Check connection of connector (TH3,TH6/TH7) on the outdoor controller circuit board. Check connection of connector (CN3) on the outdoor power circuit board. Check breaking of the lead wire for thermistor (TH3,TH6,TH7,TH8). Refer to "10-6. TEST POINT DIAGRAM" ② Check resistance value of thermistor (TH3,TH6,TH7,TH8) or check temperature by microprocessor. (Thermistor/TH3,TH6,TH7,TH8: Refer to "10-4. HOW TO CHECK THE PARTS".) (SW2 on A-Control Service Tool: Refer to "10-7. FUNCTION OF SWITCHES, CONNECTORS AND JUMPERS".) ③ Replace outdoor controller circuit board.																					
				<table border="1"> <thead> <tr> <th colspan="2">Thermistors</th> <th>Open detection</th> <th>Short detection</th> </tr> <tr> <th>Symbol</th> <th>Name</th> <td></td> <td></td> </tr> </thead> <tbody> <tr> <td>TH3</td> <td>Thermistor &lt;Liquid&gt;</td> <td>-40°C or below</td> <td>90°C or above</td> </tr> <tr> <td>TH6</td> <td>Thermistor &lt;2-phase pipe&gt;</td> <td>-40°C or below</td> <td>90°C or above</td> </tr> <tr> <td>TH7</td> <td>Thermistor &lt;Ambient&gt;</td> <td>-40°C or below</td> <td>90°C or above</td> </tr> <tr> <td>TH8</td> <td>Thermistor &lt;Heat sink&gt;</td> <td>-27°C or below</td> <td>102°C or above</td> </tr> </tbody> </table>	Thermistors		Open detection	Short detection	Symbol	Name			TH3	Thermistor <Liquid>	-40°C or below	90°C or above	TH6	Thermistor <2-phase pipe>	-40°C or below	90°C or above	TH7	Thermistor <Ambient>	-40°C or below	90°C or above
Thermistors		Open detection	Short detection																					
Symbol	Name																							
TH3	Thermistor <Liquid>	-40°C or below	90°C or above																					
TH6	Thermistor <2-phase pipe>	-40°C or below	90°C or above																					
TH7	Thermistor <Ambient>	-40°C or below	90°C or above																					
TH8	Thermistor <Heat sink>	-27°C or below	102°C or above																					
U5 (4230)	<b>Temperature of heat sink</b> Abnormal if heat sink thermistor (TH8) detects 90°C.	① The outdoor fan motor is locked. ② Failure of outdoor fan motor ③ Air flow path is clogged. ④ Rise of ambient temperature ⑤ Defective thermistor ⑥ Defective input circuit of outdoor power circuit board ⑦ Failure of outdoor fan drive circuit	①② Check outdoor fan. ③ Check air flow path for cooling. ④ Check if there is something which causes temperature rise around outdoor unit. (Upper limit of ambient temperature is 46°C.) Turn off power, and on again to check if U5 is displayed within 30 minutes. If U4 is displayed instead of U5, follow the action to be taken for U4. ⑤ Check resistance value of thermistor (TH8) or temperature by microcomputer. (Thermistor/TH8: Refer to "10-4. HOW TO CHECK THE PARTS".) (SW2 on A-Control Service Tool: Refer to "10-7. FUNCTION OF SWITCHES, CONNECTORS AND JUMPERS".) ⑥ Replace outdoor power circuit board. ⑦ Replace outdoor controller circuit board.																					
U6 (4250)	<b>Power module</b> Check abnormality by driving power module in case overcurrent is detected. (UF or UP error condition)	① Outdoor stop valve is closed. ② Decrease of power supply voltage ③ Looseness, disconnection or converse of compressor wiring connection ④ Defective compressor ⑤ Defective outdoor power circuit board	① Open stop valve. ② Check facility of power supply. ③ Correct the wiring (U-V-W phase) to compressor. Refer to "10-6. TEST POINT DIAGRAM". (Outdoor power circuit board). ④ Check compressor referring to "10-4. HOW TO CHECK THE PARTS". ⑤ Replace outdoor power circuit board.																					
U8 (4400)	<b>Outdoor fan motor</b> Abnormal if rotational frequency of the fan motor is not detected during DC fan motor operation. Fan motor rotational frequency is abnormal if; <ul style="list-style-type: none"> <li>• 100 rpm or below detected continuously for 15 seconds at 20°C or more outside air temperature.</li> <li>• 50 rpm or below or 1500 rpm or more detected continuously for 1 minute.</li> </ul>	① Failure in the operation of the DC fan motor ② Failure in the outdoor circuit controller board	① Check or replace the DC fan motor. ② Check the voltage of the outdoor circuit controller board during operation. ③ Replace the outdoor circuit controller board. (when the failure is still indicated even after performing the action ① above.)																					

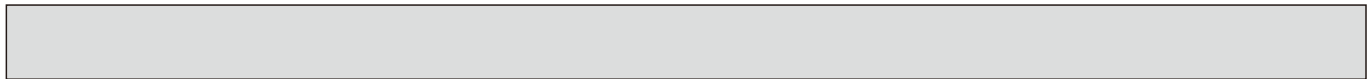

Check Code	Abnormal point and detection method	Case	Judgment and action	
U9 (4220)	Detailed codes	To find out the detail history (latest) about U9 error, turn ON SW2-1, 2-2 and 2-6. Refer to "10-7. FUNCTION OF SWITCHES, CONNECTORS AND JUMPERS".		
	01	<b>Overvoltage error</b> • Increase in DC bus voltage to 760 V	① Abnormal increase in power source voltage ② Disconnection of compressor wiring ③ Defective outdoor power circuit board ④ Compressor has a ground fault.	① Check the field facility for the power supply. ② Correct the wiring (U·V·W phase) to compressor. Refer to "10-6. TEST POINT DIAGRAM" (Outdoor power circuit board). ③ Replace outdoor power circuit board. ④ Check compressor for electrical insulation. Replace compressor.
	02	<b>Undervoltage error</b> • Instantaneous decrease in DC bus voltage to 400 V	① Decrease in power source voltage, instantaneous stop. ② Defective 52C drive circuit in outdoor power circuit board ③ Disconnection or loose connection of rush current protect resistor RS ④ Defective rush current protect resistor RS	① Check the field facility for the power supply. ② Replace outdoor power circuit board. ③ Check RS wiring. ④ Replace RS.
	04	<b>Input current sensor error/ L1-phase open error</b> • Decrease in input current through outdoor unit to 0.1A only if operation frequency is more than or equal to 40Hz or compressor current is more than or equal to 6A.	① L1-phase open ② Disconnection or loose connection between TB1 and outdoor noise filter circuit board ③ Disconnection or loose connection of CN5 on the outdoor power circuit board/CNCT on the outdoor noise filter board ④ Defective ACCT (AC current trans) on the outdoor noise filter circuit board ⑤ Defective input current detection circuit in outdoor power circuit board ⑥ Defective outdoor controller circuit board	① Check the field facility for the power supply. ② Check the wiring between TB1 and outdoor noise filter circuit board. ③ Check CN5/CNCT wiring. ④ Replace outdoor noise filter circuit board. ⑤ Replace outdoor power circuit board. ⑥ Replace outdoor controller circuit board.
	08	<b>Abnormal power synchronous signal</b> • No input of power synchronous signal to power circuit board • Power synchronous signal of 44 Hz or less, or 65 Hz or more is detected on power circuit board.	① Distortion of power source voltage, noise superimposition. ② Disconnection or loose connection of earth wiring ③ Disconnection or loose connection of CN2 on the outdoor power circuit board /controller circuit board ④ Defective power synchronous signal circuit in outdoor controller circuit board ⑤ Defective power synchronous signal circuit in outdoor power circuit board	① Check the field facility for the power supply. ② Check earth wiring. ③ Check CN2 wiring. ④ Replace outdoor controller circuit board. ⑤ Replace outdoor power circuit board.
	10	<b>PFC error (Overvoltage/ Undervoltage/Overcurrent)</b> • PFC detected any of the following: a) Increase of DC bus voltage to 420 V. b) Decrease in PFC control voltage to 12 V DC or lower. c) Increase in input current to 50 A peak. (For models equipped with single-phase PFC only)	Not applicable for SW160/200Y model.	Check the switch setting for Model Select on the outdoor controller circuit board.
	20	<b>PFC/IGBT error (Undervoltage)</b> • When Compressor is running, DC bus voltage stays at 310V or lower for consecutive 10 seconds. (For models equipped with single-phase PAM converter only)	Not applicable for SW160/200Y model.	Check the switch setting for Model Select on the outdoor controller circuit board.

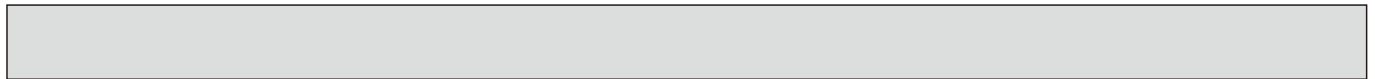

Check Code	Abnormal point and detection method	Case	Judgment and action
Ud (1504)	<b>Over heat protection</b> Abnormal if thermistor <liquid> (TH3) detects 70°C or more during compressor operation.	① Defective outdoor fan (fan motor) or short cycle of outdoor unit during cooling operation ② Defective thermistor <liquid> (TH3) ③ Defective outdoor controller board	① Check outdoor unit air passage.  ②③ Turn the power off and on again to check the check code. If U4 is displayed, follow the U4 processing direction.
UE	<b>Abnormal pressure of pressure sensor (63HS)</b> Abnormal if pressure sensor (63HS) detects 0.1 MPa or less. Detection is inoperative for 3 minutes after compressor starting and 3 minutes after and during defrosting.	① Disconnection or contact failure of connector (63HS) on the outdoor controller circuit board ② Defective pressure sensor ③ Defective outdoor controller circuit board	① Check connection of connector (63HS) on the outdoor controller circuit board. Check breaking of the lead wire for thermistor (63HS). ② Check pressure by microprocessor. (Pressure sensor/ 63HS) (SW2: Refer to "10-7. FUNCTION OF SWITCHES, CONNECTORS AND JUMPERS". ) ③ Replace outdoor controller board.
UF (4100)	<b>Compressor overcurrent interruption (When compressor locked)</b> Abnormal if overcurrent of DC bus or compressor is detected within 30 seconds after compressor starts operating.	① Stop valve is closed. ② Decrease of power supply voltage ③ Looseness, disconnection or converse of compressor wiring connection ④ Defective compressor  ⑤ Defective outdoor power board ⑥ DIP switch setting difference of outdoor controller circuit board.	① Open stop valve. ② Check facility of power supply.  ③ Correct the wiring (U-V-W phase) to compressor. Refer to "10-6. TEST POINT DIAGRAM" (Outdoor power circuit board). ④ Check compressor. Refer to "10-4. HOW TO CHECK THE PARTS". ⑤ Replace outdoor power circuit board. ⑥ Check the dip switch setting of outdoor controller circuit board. Refer to "Model Select" in "1) Function of switches" in "10-7. FUNCTION OF SWITCHES, CONNECTORS AND JUMPERS".
UH (5300)	<b>Current sensor error or input current error</b> • Abnormal if current sensor detects -1.0A to 1.0A during compressor operation. (This error is ignored in case of test run mode.)	① Disconnection of compressor wiring ② Defective circuit of current sensor on outdoor power circuit board ③ Decrease of power supply voltage ④ Leakage or shortage of refrigerant	① Correct the wiring (U-V-W phase) to compressor. Refer to "10-6. TEST POINT DIAGRAM" (Outdoor power circuit board). ② Replace outdoor power circuit board.  ③ Check the facility of power supply. ④ Check leakage of refrigerant.
UL (1300)	<b>Low pressure</b> Abnormal if the following conditions are detected for continuously 3 minutes after compressor starts heating operating for 10 minutes. 1. Heating mode • Detection mode 1 TH7-TH3 $\leq 4^{\circ}\text{C}$ and T <sub>63HS</sub> -Indoor room temperature $\leq 2^{\circ}\text{C}$ • Detection mode 2 TH7-TH3 $\leq 2^{\circ}\text{C}$ , T <sub>63HS</sub> -Indoor room temperature $\leq 4^{\circ}\text{C}$ and TH2-Indoor room temperature $\leq 4^{\circ}\text{C}$  2. Cooling mode TH6-TH7 $\leq 2^{\circ}\text{C}$ and TH3-TH7 $\leq 2^{\circ}\text{C}$ and Indoor room temperature-Indoor liquid pipe temperature (TH2) $\leq 5^{\circ}\text{C}$  Thermistor TH3: Outdoor liquid pipe temperature TH6: Outdoor 2-phase pipe temperature TH7: Ambient temperature T <sub>63HS</sub> : Condensing temperature	① Stop valve of outdoor unit is closed during operation. ② Leakage or shortage of refrigerant  ③ Malfunction of linear expansion valve ④ Clogging with foreign objects in refrigerant circuit Note: Clogging occurs in the parts which become below freezing point when water enters in refrigerant circuit.	① Check stop valve.  ② Check intake superheat. Check leakage of refrigerant. Check additional refrigerant.  ③ Check linear expansion valve. Refer to "10-4. HOW TO CHECK THE PARTS". ④ After recovering refrigerant, remove water from entire refrigerant circuit under vacuum more than 1 hour.



Check Code	Abnormal points and detection method	Case	Judgment and action
UP (4210)	<p><b>Compressor overcurrent interruption</b> Abnormal if overcurrent DC bus or compressor is detected after compressor starts operating for 30 seconds.</p>	<ul style="list-style-type: none"> <li>① Stop valve of outdoor unit is closed.</li> <li>② Decrease of power supply voltage</li> <li>③ Looseness, disconnection or converse of compressor wiring connection</li> <li>④ Defective fan of outdoor units</li> <li>⑤ Short cycle of outdoor units</li> <li>⑥ Defective input circuit of outdoor controller board</li> <li>⑦ Defective compressor</li> <li>⑧ Defective outdoor power circuit board</li> <li>⑨ DIP switch setting difference of outdoor controller circuit board</li> </ul>	<ul style="list-style-type: none"> <li>① Open stop valve.</li> <li>② Check facility of power supply.</li> <li>③ Correct the wiring (U-V-W phase) to compressor. Refer to "10-6. TEST POINT DIAGRAM". (Outdoor power circuit board).</li> <li>④ Check outdoor fan.</li> <li>⑤ Solve short cycle.</li> <li>⑥ Replace outdoor controller circuit board.</li> <li>⑦ Check compressor. Refer to "10-4. HOW TO CHECK THE PARTS".</li> </ul> <p>Before the replacement of the outdoor controller circuit board, disconnect the wiring to compressor from the outdoor power circuit board and check the output voltage among phases, U, V, W, during test run. No defect on board if voltage among phases (U-V, V-W and W-U) is same. Make sure to perform the voltage check with same performing frequency.</p> <ul style="list-style-type: none"> <li>⑧ Replace outdoor power circuit board</li> <li>⑨ Check the DIP switch setting of outdoor controller circuit board</li> </ul>
E0 or E4	<p><b>Remote controller transmission error (E0)/signal receiving error (E4)</b></p> <ul style="list-style-type: none"> <li>① Abnormal if main or sub remote controller cannot receive normally any transmission from indoor unit of refrigerant address "0" for 3 minutes. (Check code : E0)</li> <li>② Abnormal if sub remote controller could not receive any signal for 2 minutes. (Check code: E0)</li> </ul> <ul style="list-style-type: none"> <li>① Abnormal if indoor controller board cannot receive normally any data from remote controller board or from other indoor controller board for 3 minutes. (Check code: E4)</li> <li>② Indoor controller board cannot receive any signal from remote controller for 2 minutes. (Check code: E4)</li> </ul>	<ul style="list-style-type: none"> <li>① Contact failure at transmission wire of remote controller</li> <li>② All remote controllers are set as "sub" remote controller. In this case, E0 is displayed on remote controller, and E4 is displayed at LED (LED1, LED2) on the outdoor controller circuit board.</li> <li>③ Miswiring of remote controller</li> <li>④ Defective transmitting receiving circuit of remote controller</li> <li>⑤ Defective transmitting receiving circuit of indoor controller board of refrigerant address "0"</li> <li>⑥ Noise has entered into the transmission wire of remote controller.</li> </ul>	<ul style="list-style-type: none"> <li>① Check disconnection or looseness of indoor unit or transmission wire of remote controller.</li> <li>② Set one of the remote controllers "main" if there is no problem with the action above.</li> <li>③ Check wiring of remote controller. Refer to the indoor unit's Installation Manual for remote controller connection.</li> </ul> <p>If the cause of trouble is not any of ①-③ above,</p> <ul style="list-style-type: none"> <li>④ Diagnose remote controllers. <ul style="list-style-type: none"> <li>a) When "RC OK" is displayed, remote controllers have no problem. Turn the power off, and on again to check. If abnormality generates again, replace indoor controller board.</li> <li>b) When "RC NG" is displayed, replace remote controller.</li> <li>c) When "RC E3" or "ERC 00-66" is displayed, noise may be causing abnormality.</li> </ul> </li> </ul>
E1 or E2	<p><b>Remote controller control board</b></p> <ul style="list-style-type: none"> <li>① Abnormal if data cannot be normally read from the nonvolatile memory of the remote controller control board. (Check code: E1)</li> <li>② Abnormal if the clock function of remote controller cannot be normally operated. (Check code: E2)</li> </ul>	<ul style="list-style-type: none"> <li>① Defective remote controller</li> </ul>	<ul style="list-style-type: none"> <li>① Replace remote controller.</li> </ul>



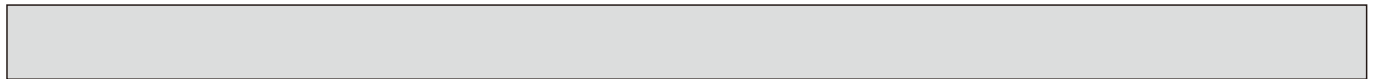

Check Code	Abnormal points and detection method	Case	Judgment and action
E3 or E5	<b>Remote controller transmission error (E3)/signal receiving error (E5)</b> ① Abnormal if remote controller could not find blank of transmission path for 6 seconds and could not transmit. (Check code: E3) ② Remote controller receives transmitted data at the same time, compares the data, and when detecting it, judges different data to be abnormal 30 continuous times. (Check code: E3) ③ Abnormal if indoor controller board could not find blank of transmission path. (Check code: E5) ④ Indoor controller board receives transmitted data at the same time, compares the data, and when detecting it, judges different data to be abnormal 30 continuous times. (Check code: E5)	① 2 remote controllers are set as "main." (In case of 2 remote controllers) Refer to the indoor unit's Installation Manual for remote controller connection. ② Repetition of refrigerant address ③ Defective transmitting receiving circuit of remote controller ④ Defective transmitting receiving circuit of indoor controller board ⑤ Noise has entered into transmission wire of remote controller.	① Set a remote controller to main, and the other to sub. ② The address changes to a separate setting. ③-⑤ Diagnose remote controller. a) When "RC OK" is displayed, remote controllers have no problem. Turn the power off, and on again to check. When becoming abnormal again, replace indoor controller board. b) When "RC NG" is displayed, replace remote controller. c) When "RC E3" or "ERC 00-66" is displayed, noise may be causing abnormality.
E6 (6840)	<b>Indoor/outdoor unit communication error (Signal receiving error)</b> ① Abnormal if indoor controller board could not receive any signal normally for 6 minutes after turning the power on. ② Abnormal if indoor controller board could not receive any signal normally for 3 minutes. ③ Consider the unit as abnormal under the following condition. When 2 or more indoor units are connected to an outdoor unit, indoor controller board could not receive a signal for 3 minutes from outdoor controller circuit board, a signal which allows outdoor controller circuit board to transmit signals.	① Contact failure, short circuit or miswiring (converse wiring) of indoor/outdoor unit connecting wire ② Defective transmitting receiving circuit of outdoor controller circuit board. ③ Defective transmitting receiving circuit of indoor controller board. ④ Noise has entered into indoor/outdoor unit connecting wire. ⑤ Defective fan motor ⑥ Defective rush current resistor of outdoor power circuit board	Check LED display on outdoor controller circuit board. (Connect A-Control service tool (PAC-SK52ST)) Refer to EA-EC item if LED displays EA-AC. ① Check disconnecting or looseness of indoor / outdoor unit connecting wire of indoor unit or outdoor unit. Check all the units in case of twin/triple/quadruple indoor unit system. ②-④ Turn the power off, and on again to check. If abnormality generates again, replace indoor controller board or outdoor controller circuit board. Note: Other indoor controller board may have defect in the case of twin/triple/quadruple indoor unit system. ⑤ Turn the power off, and detach fan motor from connector (CNF1, 2). Then turn the power on again. If abnormality is not displayed, replace fan motor. If abnormality is displayed, replace outdoor controller circuit board. ⑥ Check the rush current resistor on outdoor power circuit board with tester. If open is detected, replace the power circuit board.
E7	<b>Indoor/outdoor unit communication error (Transmitting error)</b> Abnormal if "1" receiving is detected 30 times continuously though indoor controller board has transmitted "0".	① Defective transmitting receiving circuit of indoor controller board ② Noise has entered into power supply. ③ Noise has entered into outdoor control wire.	①-③ Turn the power off, and on again to check. If abnormality generates again, replace indoor controller board.
E8 (6840)	<b>Indoor/outdoor unit communication error (Signal receiving error) (Outdoor unit)</b> Abnormal if outdoor controller circuit board could not receive anything normally for 3 minutes.	① Contact failure of indoor/outdoor unit connecting wire ② Defective communication circuit of outdoor controller circuit board ③ Defective communication circuit of indoor controller board ④ Noise has entered into indoor/outdoor unit connecting wire.	① Check disconnection or looseness of indoor/outdoor unit connecting wire of indoor or outdoor units. ②-④ Turn the power off, and on again to check. Replace indoor controller board or outdoor controller circuit board if abnormality is displayed again.





Check Code	Abnormal points and detection method	Case	Judgment and action
E9 (6841)	<b>Indoor/outdoor unit communication error (Transmitting error) (Outdoor unit)</b> ① Abnormal if "0" receiving is detected 30 times continuously though outdoor controller circuit board has transmitted "1". ② Abnormal if outdoor controller circuit board could not find blank of transmission path for 3 minutes.	① Indoor/ outdoor unit connecting wire has contact failure. ② Defective communication circuit of outdoor controller circuit board ③ Noise has entered power supply. ④ Noise has entered indoor/ outdoor unit connecting wire.	① Check disconnection or looseness of indoor/ outdoor unit connecting wire. ②-④ Turn the power off, and on again to check. Replace outdoor controller circuit board if abnormality is displayed again.
EF (6607 or 6608)	<b>Non defined check code</b> This code is displayed when non defined check code is received.	① Noise has entered transmission wire of remote controller. ② Noise has entered indoor/ outdoor unit connecting wire. ③ Outdoor unit is not a series of power-inverter.	①② Turn the power off, and on again to check. Replace indoor controller board or outdoor controller circuit board if abnormality is displayed again. ③ Replace outdoor unit with power-inverter type outdoor unit.
Ed (0403)	<b>Serial communication error</b> ① Abnormal if serial communication between outdoor controller circuit board and outdoor power circuit board is defective.	① Breaking of wire or contact failure of connector CN2 between the outdoor controller circuit board and the outdoor power circuit board ② Breaking of wire or contact failure of connector CN4 between the outdoor controller circuit board and the outdoor power circuit board ③ Defective communication circuit of outdoor power circuit board ④ Defective communication circuit of outdoor controller circuit board for outdoor power circuit board	①② Check connection of each connector CN2 and CN4 between the outdoor controller circuit board and the outdoor power circuit board. ③ Replace outdoor power circuit board. ④ Replace outdoor controller circuit board.
PL	<b>Abnormal refrigerant circuit</b> During Cooling operation, the following conditions are regarded as failures when detected for 1 second. a) The compressor continues to run for 30 or more seconds. b) The liquid pipe temperature or the condenser/evaporator temperature is 75°C or more. <b><u>These detected errors will not be cancelled until the power source is reset.</u></b>	① Abnormal operation of 4-way valve ② Disconnection of or leakage in refrigerant pipes ③ Air into refrigerant piping ④ Defective refrigerant circuit (clogging)	① <b><u>When this error occurs, be sure to replace the 4-way valve.</u></b> ② Check refrigerant pipes for disconnection or leakage. ③ After the recovery of refrigerant, vacuum dry the whole refrigerant circuit. ④ Check refrigerant circuit for operation. <b><u>To avoid entry of moisture or air into refrigerant circuit which could cause abnormal high pressure, purge air in refrigerant circuit or replace refrigerant.</u></b>

### 10-3. TROUBLESHOOTING OF PROBLEMS

Phenomena	Factor	Countermeasure
1. Remote controller display does not work.	<ul style="list-style-type: none"> <li>① 12 V DC is not supplied to remote controller. (Power supply display ● is not indicated on LCD.)</li> <li>② 12–15 V DC is supplied to remote controller, however, no display is indicated. <ul style="list-style-type: none"> <li>• “PLEASE WAIT” is not displayed.</li> <li>• “PLEASE WAIT” is displayed.</li> </ul> </li> </ul>	<ul style="list-style-type: none"> <li>① Check LED2 on indoor controller board. <ul style="list-style-type: none"> <li>(1) When LED2 is lit. Check the remote controller wiring for breaking or contact failure.</li> <li>(2) When LED2 is blinking. Check short circuit of remote controller wiring.</li> <li>(3) When LED2 is not lit. Refer to phenomena No.3 below.</li> </ul> </li> <li>② Check the following. <ul style="list-style-type: none"> <li>• Failure of remote controller if “PLEASE WAIT” is not displayed</li> <li>• Refer to phenomena No.2 below if “PLEASE WAIT” is displayed.</li> </ul> </li> </ul>
2. “PLEASE WAIT” display is remained on the remote controller.	<ul style="list-style-type: none"> <li>① At longest 2 minutes after the power supply “PLEASE WAIT” is displayed to start up.</li> <li>② Communication error between the remote controller and indoor unit</li> <li>③ Communication error between the indoor and outdoor unit</li> <li>④ Outdoor unit protection device connector is open.</li> </ul>	<ul style="list-style-type: none"> <li>① Normal operation</li> <li>② Self-diagnosis of remote controller</li> <li>③ “PLEASE WAIT” is displayed for 6 minutes at most in case of indoor/outdoor unit communication error. Check LED3 on indoor controller board. <ul style="list-style-type: none"> <li>(1) When LED3 is not blinking. Check indoor/outdoor connecting wire for Miswiring. (Converse wiring of S1 and S2, or break of S3 wiring.)</li> <li>(2) When LED3 is blinking. Indoor/outdoor connecting wire is normal.</li> </ul> </li> <li>④ Check LED display on outdoor controller circuit board. Refer to “10-7. FUNCTION OF SWITCHES, CONNECTORS AND JUMPERS”. Check protection device connector (63H) for contact failure. Refer to “10-6. TEST POINT DIAGRAM”.</li> </ul>
3. When pressing the remote controller operation switch, the OPERATION display is appeared but it will be turned off soon.	<ul style="list-style-type: none"> <li>① After cancelling to select function from the remote controller, the remote controller operation switch will be not accepted for approx. 30 seconds.</li> </ul>	<ul style="list-style-type: none"> <li>① Normal operation</li> </ul>
4. Remote controller display works normally and the unit performs cooling operation, however, the capacity cannot be fully obtained.	<ul style="list-style-type: none"> <li>① Refrigerant shortage</li> </ul>	<ul style="list-style-type: none"> <li>① • If refrigerant leaks, discharging temperature rises and LEV opening increases. Inspect leakage by checking the temperature and opening. <ul style="list-style-type: none"> <li>• Check pipe connections for gas leakage.</li> </ul> </li> </ul>
5. Remote controller display works normally and the unit performs heating operation, however, the capacity cannot be fully obtained.	<ul style="list-style-type: none"> <li>① Linear expansion valve fault Opening cannot be adjusted well due to linear expansion valve fault.</li> <li>② Refrigerant shortage</li> <li>③ Lack of insulation for refrigerant piping</li> <li>④ Bypass circuit of outdoor unit fault</li> </ul>	<ul style="list-style-type: none"> <li>① • Discharging temperature and indoor heat exchanger temperature does not rise. Inspect the failure by checking discharging pressure. <ul style="list-style-type: none"> <li>• Replace linear expansion valve.</li> </ul> </li> <li>② • If refrigerant leaks, discharging temperature rises and LEV opening increases. Inspect leakage by checking the temperature and opening. <ul style="list-style-type: none"> <li>• Check pipe connections for gas leakage.</li> </ul> </li> <li>③ Check the insulation.</li> <li>④ Check refrigerant system during operation.</li> </ul>
6. ① For 3 minutes after temperature adjuster turns off, the compressor will not start operating even if temperature adjuster is turned on. ② For 3 minutes after temperature adjuster turns on, the compressor will not stop operating even if temperature adjuster is turned off. (Compressor stops operating immediately when turning off by the remote controller.)	<ul style="list-style-type: none"> <li>①② Normal operation (For protection of compressor)</li> </ul>	<ul style="list-style-type: none"> <li>①② Normal operation</li> </ul>

**Symptoms: "PLEASE WAIT" is kept being displayed on the remote controller.**





Diagnosis flow	Cause	Inspection method and troubleshooting
<pre> graph TD     Start[Check the display time of "PLEASE WAIT" after turning on the main power.] --&gt; D1{How long is "PLEASE WAIT" kept being displayed on the remote controller?}     D1 -- "6 minutes or more" --&gt; P1[Check the LED display of the outdoor controller circuit board.]     P1 --&gt; D2{Are any check codes displayed on the LED?}     D2 -- NO --&gt; C3[Defective indoor controller board Defective remote controller]     D2 -- YES --&gt; C2[Miswiring of indoor/outdoor connecting wire Breaking of indoor/outdoor connecting wire (S3) Defective indoor controller board Defective outdoor controller circuit board]     D1 -- "2 to 6 minutes" --&gt; D3{Are any check codes displayed on the remote controller?}     D3 -- NO --&gt; C1["PLEASE WAIT" will be displayed during the start-up diagnosis after turning on the main power.]     D3 -- YES --&gt; C2     D1 -- "2 minutes or less" --&gt; C1     </pre>	<ul style="list-style-type: none"> <li>• "PLEASE WAIT" will be displayed during the start-up diagnosis after turning on the main power.</li> <li>• Miswiring of indoor/outdoor connecting wire</li> <li>• Breaking of indoor/outdoor connecting wire (S3)</li> <li>• Defective indoor controller board</li> <li>• Defective outdoor controller circuit board</li> <li>• Defective indoor controller board</li> <li>• Defective remote controller</li> </ul>	<ul style="list-style-type: none"> <li>• Normal The startup diagnosis will be over in around 2 minutes.</li> <li>• Refer to "Self-diagnosis action table" in order to solve the trouble.</li> <li>• In case of communication errors, the display of remote controller may not match the LED display of the outdoor unit.</li> </ul>

**Symptoms: Nothing is displayed on the remote controller. ①**

LED display of the indoor controller board  
 LED1 : ○  
 LED2 : ○  
 LED3 : ○





Diagnosis flow	Cause	Inspection method and troubleshooting
<pre> graph TD     A[Check the voltage between S1 and S2 on the terminal block (TB1) of the indoor unit which is used to connect the indoor unit and the outdoor unit.] --&gt; B{198 to 264 V AC?}     B -- NO --&gt; C[Check the voltage among L(L3) and N on the terminal block (TB1) of the outdoor power circuit board.]     C --&gt; D{198 to 264 V AC?}     D -- NO --&gt; E[• Troubles concerning power supply.]     D -- YES --&gt; F[Check the voltage between S1 and S2 on the terminal block (TB1) of the outdoor unit which is used to connect the indoor unit and the outdoor unit.]     F --&gt; G{198 to 264 V AC?}     G -- NO --&gt; H[• Bad wiring of the outdoor controller board. • The fuses on the outdoor controller circuit board are blown.]     G -- YES --&gt; I[• Bad wiring of the outdoor controller board. • The fuses on the outdoor controller circuit board are blown.]             </pre>	<ul style="list-style-type: none"> <li>• Troubles concerning power supply.</li> <li>• Bad wiring of the outdoor controller board.</li> <li>• The fuses on the outdoor controller circuit board are blown.</li> <li>• Bad wiring of the outdoor controller board.</li> <li>• The fuses on the outdoor controller circuit board are blown.</li> </ul>	<ul style="list-style-type: none"> <li>• Check the power wiring to the outdoor unit.</li> <li>• Check the breaker.</li> <li>• Check the wiring of the outdoor unit.</li> <li>• Check if the wiring is bad. Check if the fuses are blown. The fuses on the outdoor controller circuit board will be blown when the indoor /outdoor connecting wire short-circuits.</li> <li>• Check if miswiring, breaking or poor contact is causing this problem. Indoor/outdoor connecting wire is polarized 3-core type. Connect the indoor unit and the outdoor unit by wiring each pair of S1, S2 and S3 on the both side of indoor/outdoor terminal blocks.</li> </ul>

## Symptoms: Nothing is displayed on the remote controller. ②

LED display of the indoor controller board  
 LED1 :   
 LED2 :   
 LED3 :  or 

Diagnosis flow	Cause	Inspection method and troubleshooting
<p>Check the voltage between S1 and S2 on the terminal block (TB1) of the indoor unit which is used to connect the indoor unit and the outdoor unit.</p> <p>198 to 264 V AC?</p> <p>NO</p> <p>YES</p> <p>Check the status of the indoor controller board LED3 display.</p> <p>Not lighting.</p> <p>Blinking.</p> <p>Check the looseness or disconnection of the indoor/outdoor connecting wire.</p> <p>Are there looseness or disconnection of the indoor/outdoor connecting wire?</p> <p>YES</p> <p>NO</p> <p>Check the refrigerant address of the outdoor unit. (SW1-3 to 1-6)</p> <p>Is the refrigerant address "0"?</p> <p>NO</p> <p>YES</p> <p>Check the LED display of the outdoor unit after turning on the main power again.</p> <p>Is anything displayed?</p> <p>Not displayed.</p> <p>Displayed.</p> <p>Is "EA" or "Eb" displayed?</p> <p>NO</p> <p>YES</p> <p>Is "E8" displayed?</p> <p>YES</p> <p>NO</p> <p>Can the unit be restarted?</p> <p>Can all the indoor unit be operated?</p> <p>NO</p> <p>YES</p> <p>Check the voltage between S2 and S3 on the terminal block of the outdoor unit.</p> <p>17 to 28 V DC?</p> <p>NO</p> <p>YES</p>	<ul style="list-style-type: none"> <li>• Breaking or poor contact of the indoor/outdoor connecting wire</li> <li>• Normal. Only the unit which has the refrigerant address "0" supplies power to the remote controller.</li> <li>• Defective outdoor controller circuit board</li> <li>• Defective outdoor controller circuit board</li> <li>• Defective indoor controller board</li> <li>• Influence of electromagnetic noise</li> <li>• Defective outdoor power circuit board</li> <li>• Defective indoor power board</li> </ul>	<ul style="list-style-type: none"> <li>• Fix the breaking or poor contact of the indoor/outdoor connecting wire.</li> <li>• Set the refrigerant address to "0". In case of the multiple grouping system, recheck the refrigerant address again.</li> <li>• Replace the outdoor controller circuit board.</li> <li>• Replace the outdoor controller circuit board.</li> <li>• Replace the indoor controller board of the indoor unit which does not operate.</li> <li>• Not abnormal. There may be the influence of electromagnetic noise. Check the transmission wire and get rid of the causes.</li> <li>• Replace the outdoor power circuit board.</li> <li>• Replace the indoor power board.</li> </ul>

**Symptoms: Nothing is displayed on the remote controller. ③**

LED display of the indoor controller board  
 LED1 :   
 LED2 :  or   
 LED3 : 

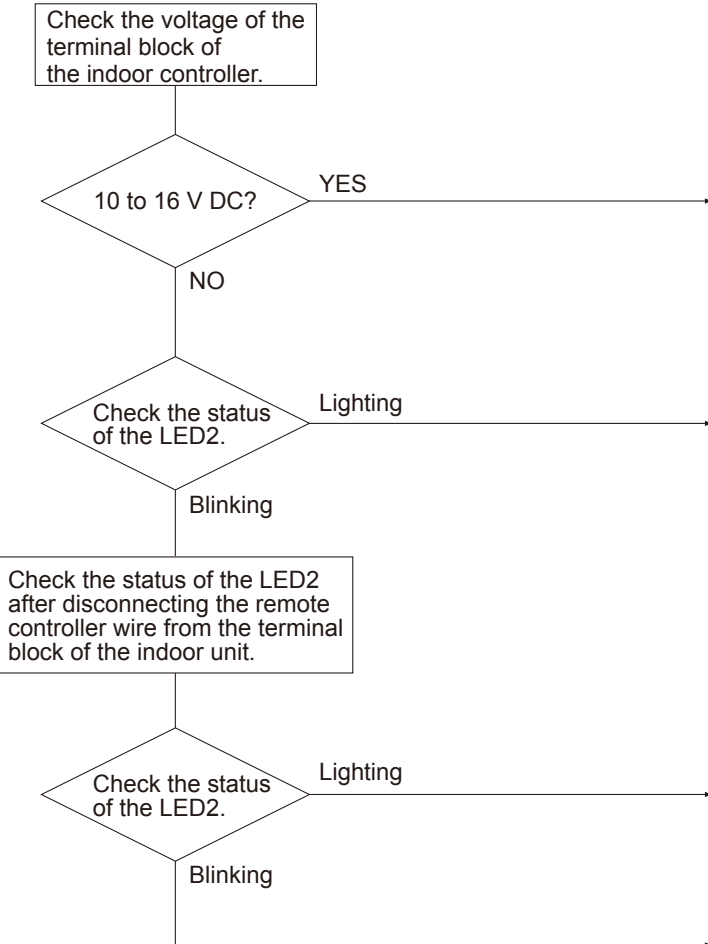
Diagnosis flow	Cause	Inspection method and troubleshooting
 <pre> graph TD     A[Check the voltage of the terminal block of the indoor controller.] --&gt; B{10 to 16 V DC?}     B -- YES --&gt; C[Defective remote controller]     B -- NO --&gt; D{Check the status of the LED2.}     D -- Lighting --&gt; E[Breaking or poor contact of the remote controller wire]     D -- Blinking --&gt; F[Check the status of the LED2 after disconnecting the remote controller wire from the terminal block of the indoor unit.]     F --&gt; G{Check the status of the LED2.}     G -- Lighting --&gt; H[The remote controller wire short-circuits]     G -- Blinking --&gt; I[Defective indoor controller board]                     </pre>	<ul style="list-style-type: none"> <li>• Defective remote controller</li> <li>• Breaking or poor contact of the remote controller wire</li> <li>• The remote controller wire short-circuits</li> <li>• Defective indoor controller board</li> </ul>	<ul style="list-style-type: none"> <li>• Replace the remote controller.</li> <li>• Check if there is breaking or poor contact of the remote controller wire. Check the voltage of the terminal block connecting the remote controller wire. If it is not between 10 and 16 V DC, the indoor controller board must be defective.</li> <li>• Check if the remote controller wire is short-circuited.</li> <li>• Replace the indoor controller board.</li> </ul>

• **Before repair**  
**Frequent calling from customers**

Phone Calls From Customers		How To Respond	Note
Unit does not operate at all.	① The operating display of remote controller does not come on.	① Check if power is supplied to air conditioner. Nothing appears on the display unless power is supplied.	_____
	② Unit cannot be restarted for a while after it's stopped.	② Wait around 3 minutes to restart unit. The air conditioner is in a state of being protected by the microcomputer's directive. Once the compressor is stopped, the unit cannot be restarted for 3 minutes. This control is also applied when the unit is turned on and off by remote controller.	_____
	③ Check code appears and blinks on the display of remote controller.	③ Check code will be displayed if any protection devices of the air conditioner are actuated. What is check code? -----	Refer to "SELF-DIAGNOSIS ACTION TABLE". ▶ Check if servicing is required for the error.
Remote controller	① "PLEASE WAIT" is displayed on the screen.	① Wait around 2 minutes. An automatic startup test will be conducted for 2 minutes when power is supplied to the air conditioner. "PLEASE WAIT" will be kept displayed during that time.	_____
	② "STANDBY" is displayed on the screen.	② This is displayed when the unit starts HEAT operation, when the thermostat puts the compressor in operation mode, or when the outdoor unit ends DEFROST operation and returns to HEAT operation. The display will automatically disappear around 10 minutes later. While "STANDBY" is displayed on the remote controller, the airflow amount will be restricted because the indoor unit's heat exchanger is not fully heated up. In addition to that, the up/down vane will be automatically set to horizontal blow in order to prevent cold air from directly blowing out to human body. The up/down vane will return to the setting specified by the remote controller when "STANDBY" is released.	_____
	③ "DEFROST" is displayed on the screen. (No air comes out of the unit.)	③ The outdoor unit gets frosted when the outside temperature is low and the humidity is high. "DEFROST" indicates the DEFROST operation is being performed to melt this frost. The DEFROST operation ends in around 10 minutes (at most 15 minutes). During the DEFROST operation, the indoor unit's heat exchanger becomes cold, so the fan is stopped. The up/down vane will be automatically set to horizontal blow in order to prevent cold air from directly blowing out to human body. The display will turn into "STANDBY" when DEFROST operation ends.	_____





Phone Calls From Customers		How To Respond	Note
The room cannot be cooled or heated sufficiently.		① Check the set temperature of remote controller. The outdoor unit cannot be operated if the set temperature is not appropriate. The outdoor unit operates in the following modes. COOL: When the set temperature is lower than the room temperature. HEAT: When the set temperature is higher than the room temperature.	_____
		② Check there is enough space around the air conditioner. If there are any obstacles in the air intake or air outlet of indoor/outdoor units, they block the airflow direction so that the unit capacity will be lowered.	_____
Sound comes out from the air conditioner.	① A gas escaping sound is heard sometimes.	① This is not a malfunction. This is the sound which is heard when the flow of refrigerant in the air conditioner is switched.	_____
	② A cracking sound is heard sometimes.	② This is not a malfunction. This is the sound which is heard when internal parts of units expand or contract when the temperature changes.	_____
	③ A buzzing sound is heard sometimes.	③ This is not a malfunction. This is the sound which is heard when the outdoor unit starts operating.	_____
	④ A ticking sound is heard from the outdoor unit sometimes.	④ This is not a malfunction. This is the sound which is heard when the fan of the outdoor unit is controlling the airflow amount in order to keep the optimum operating condition.	_____
	⑤ A sound, similar to water flowing, is heard from the unit.	⑤ This is not a malfunction. This is the sound which is heard when the refrigerant is flowing inside the indoor unit.	_____
A white mist is expelled from the indoor unit.		This is not a malfunction. This may occur when the operation gets started in the room of high humidity.	_____
Water or moisture is expelled from the outdoor unit.		COOL: when pipes or piping joints are cooled, they get sweated and water drips down. HEAT: water drips down from the heat exchanger. Note: Make use of optional parts "Drain Socket" and "Drain pan" if these water needs to be collected and drained out for once.	_____
The display of wireless remote controller gets dim or does not come on. The indoor unit does not receive a signal from remote controller at a long distance.		Batteries are being exhausted. Replace them and press the reset button of remote controller.	_____

### 10-4. HOW TO CHECK THE PARTS

PUHZ-SW160YKA.UK

PUHZ-SW200YKA.UK

PUHZ-SW160YKA-BS.UK

PUHZ-SW200YKA-BS.UK

PUHZ-SW160YKAR1.UK

PUHZ-SW200YKAR1.UK

PUHZ-SW160YKAR1-BS.UK

PUHZ-SW200YKAR1-BS.UK

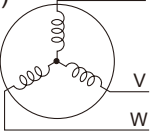
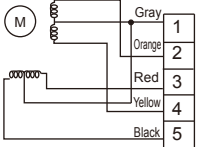
Parts name	Check points														
Thermistor (TH3) <Liquid> Thermistor (TH6) <2-phase pipe> Thermistor (TH7) <Ambient> Thermistor (TH8) <Heat sink> Thermistor (TH32) <Comp. Surface>	Disconnect the connector then measure the resistance with a tester. (At the ambient temperature 10 to 30°C) <table border="1" style="margin-left: 20px;"> <thead> <tr> <th></th> <th>Normal</th> <th>Abnormal</th> </tr> </thead> <tbody> <tr> <td>TH32</td> <td>160 to 410 kΩ</td> <td rowspan="4">Open or short</td> </tr> <tr> <td>TH3</td> <td rowspan="3">4.3 to 9.6 kΩ</td> </tr> <tr> <td>TH6</td> </tr> <tr> <td>TH7</td> </tr> <tr> <td>TH8</td> <td>39 to 105 kΩ</td> </tr> </tbody> </table>		Normal	Abnormal	TH32	160 to 410 kΩ	Open or short	TH3	4.3 to 9.6 kΩ	TH6	TH7	TH8	39 to 105 kΩ		
	Normal	Abnormal													
TH32	160 to 410 kΩ	Open or short													
TH3	4.3 to 9.6 kΩ														
TH6															
TH7															
TH8	39 to 105 kΩ														
Fan motor(MF1,MF2)	Refer to the next page.														
Solenoid valve coil <4-way valve> (21S4)	Measure the resistance between the terminals with a tester. (At the ambient temperature 20°C) <table border="1" style="margin-left: 20px;"> <thead> <tr> <th>Normal</th> <th>Abnormal</th> </tr> </thead> <tbody> <tr> <td>1215 ± 122 Ω</td> <td>Open or short</td> </tr> </tbody> </table>	Normal	Abnormal	1215 ± 122 Ω	Open or short										
Normal	Abnormal														
1215 ± 122 Ω	Open or short														
Motor for compressor (MC) 	Measure the resistance between the terminals with a tester. (Winding temperature 20°C) <table border="1" style="margin-left: 20px;"> <thead> <tr> <th>Normal</th> <th>Abnormal</th> </tr> </thead> <tbody> <tr> <td>Refer to "5-2. COMPRESSOR TECHNICAL DATA".</td> <td>Open or short</td> </tr> </tbody> </table>	Normal	Abnormal	Refer to "5-2. COMPRESSOR TECHNICAL DATA".	Open or short										
Normal	Abnormal														
Refer to "5-2. COMPRESSOR TECHNICAL DATA".	Open or short														
Linear expansion valve (LEV-A) 	Disconnect the connector then measure the resistance with a tester. (Winding temperature 20°C) <table border="1" style="margin-left: 20px;"> <thead> <tr> <th colspan="4">Normal</th> <th>Abnormal</th> </tr> </thead> <tbody> <tr> <td>Gray - Black</td> <td>Gray - Red</td> <td>Gray - Yellow</td> <td>Gray - Orange</td> <td rowspan="2">Open or short</td> </tr> <tr> <td colspan="4" style="text-align: center;">46 ± 3 Ω</td> </tr> </tbody> </table>	Normal				Abnormal	Gray - Black	Gray - Red	Gray - Yellow	Gray - Orange	Open or short	46 ± 3 Ω			
Normal				Abnormal											
Gray - Black	Gray - Red	Gray - Yellow	Gray - Orange	Open or short											
46 ± 3 Ω															

## Check method of DC fan motor (fan motor/outdoor controller circuit board)

### ① Notes

- High voltage is applied to the connector (CNF1, 2) for the fan motor. Pay attention to the service.
- Do not pull out the connector (CNF1, 2) for the motor with the power supply on.  
(It causes trouble of the outdoor controller circuit board and fan motor.)

### ② Self check

Symptom : The outdoor fan cannot rotate.

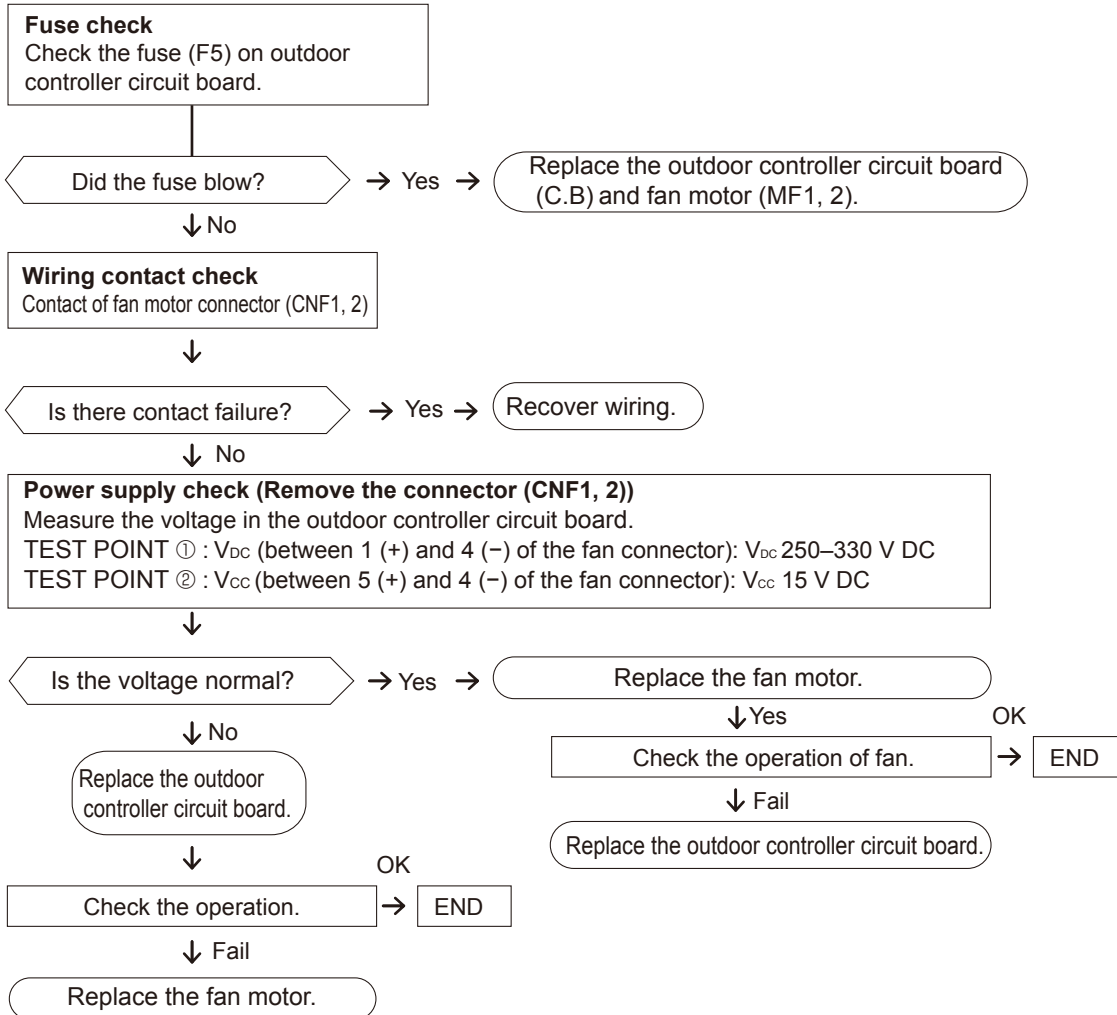

## 10-5. HOW TO CHECK THE COMPONENTS

### <HIGH PRESSURE SENSOR>

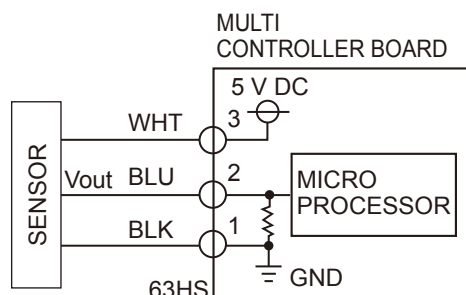
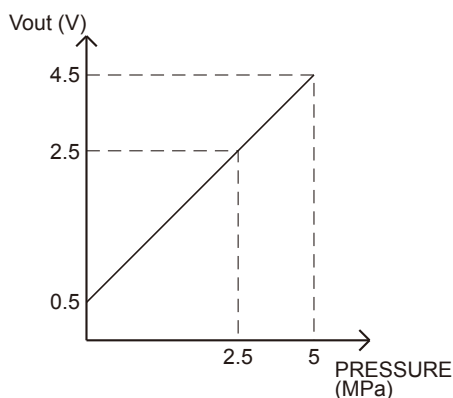

- ③-① : 5 V (DC)
- ②-① : Output Vout (DC)

**<Thermistor feature chart>**

**Low temperature thermistors**

- Thermistor <Liquid> (TH3)
- Thermistor <2-phase pipe> (TH6)
- Thermistor <Ambient> (TH7)

Thermistor R0 = 15 kΩ ± 3%  
 B constant = 3480 ± 2%

$$R_t = 15 \exp\left\{3480 \left( \frac{1}{273+t} - \frac{1}{273} \right)\right\}$$

0°C	15 kΩ	30°C	4.3 kΩ
10°C	9.6 kΩ	40°C	3.0 kΩ
20°C	6.3 kΩ		
25°C	5.2 kΩ		

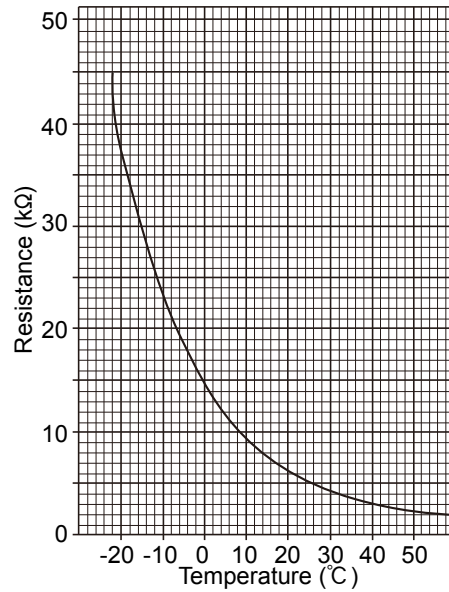

**Medium temperature thermistor**

- Thermistor <Heat sink> (TH8)

Thermistor R50 = 17 kΩ ± 2%  
 B constant = 4150 ± 3%

$$R_t = 17 \exp\left\{4150 \left( \frac{1}{273+t} - \frac{1}{323} \right)\right\}$$

0°C	180 kΩ
25°C	50 kΩ
50°C	17 kΩ
70°C	8 kΩ
90°C	4 kΩ

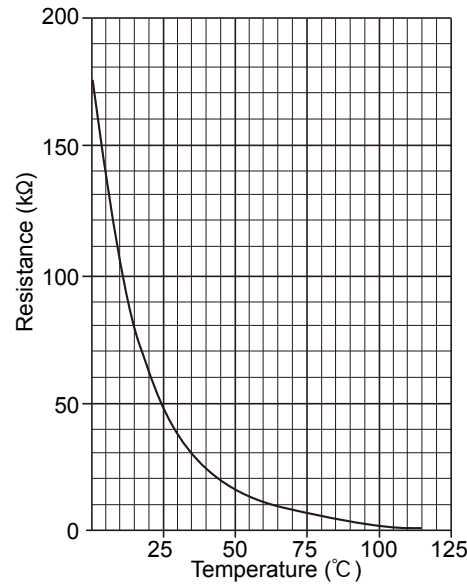

**High temperature thermistor**

- Thermistor <Comp. Surface> (TH32)

Thermistor R120 = 7.465 kΩ ± 2%  
 B constant = 4057 ± 2%

$$R_t = 7.465 \exp\left\{4057 \left( \frac{1}{273+t} - \frac{1}{393} \right)\right\}$$

20°C	250 kΩ	70°C	34 kΩ
30°C	160 kΩ	80°C	24 kΩ
40°C	104 kΩ	90°C	17.5 kΩ
50°C	70 kΩ	100°C	13.0 kΩ
60°C	48 kΩ	110°C	9.8 kΩ

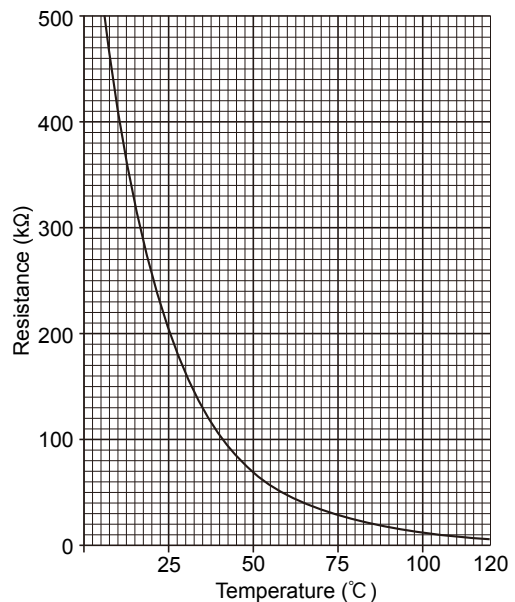

## Linear expansion valve

### (1) Operation summary of the linear expansion valve

- Linear expansion valve opens/closes through stepping motor after receiving the pulse signal from the outdoor controller circuit board.
- Valve position can be changed in proportion to the number of pulse signal.

<Connection between the outdoor controller board and the linear expansion valve>

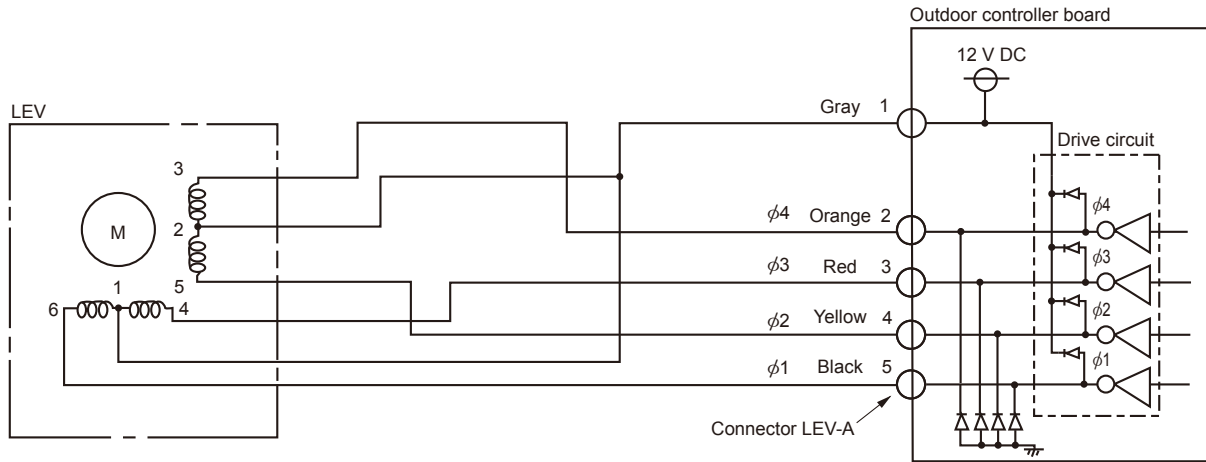

### <Output pulse signal and the valve operation>

Output (Phase)	Output							
	1	2	3	4	5	6	7	8
φ1	ON	ON	OFF	OFF	OFF	OFF	OFF	ON
φ2	OFF	ON	ON	ON	OFF	OFF	OFF	OFF
φ3	OFF	OFF	OFF	ON	ON	ON	OFF	OFF
φ4	OFF	OFF	OFF	OFF	OFF	ON	ON	ON

Opening a valve : 8 → 7 → 6 → 5 → 4 → 3 → 2 → 1 → 8

Closing a valve : 1 → 2 → 3 → 4 → 5 → 6 → 7 → 8 → 1

The output pulse shifts in above order.

- When linear expansion valve operation stops, all output phases become OFF.

### (2) Linear expansion valve operation

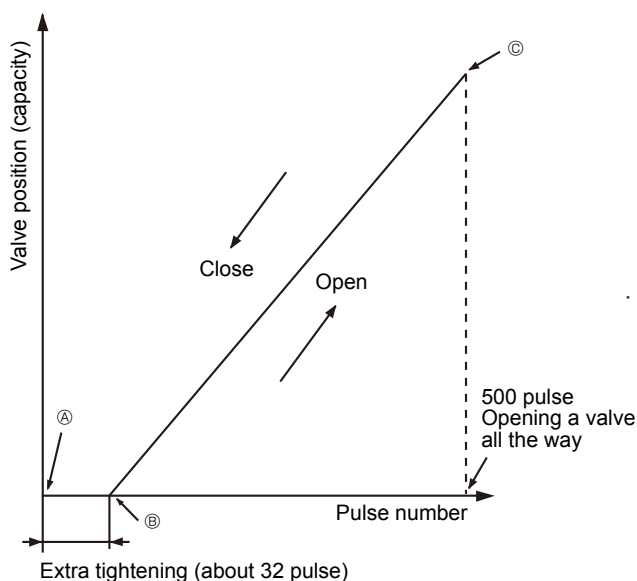

- When the switch is turned on, 700 pulse closing valve signal will be sent till it goes to ① point in order to define the valve position. (The pulse signal is being sent for about 20 seconds.)

When the valve moves smoothly, there is no sound or vibration occurring from the linear expansion valve : however, when the pulse number moves from ② to ① or when the valve is locked, more sound can be heard.

No sound is heard when the pulse number moves from ③ to ① in case coil is burnt out or motor is locked by open-phase.

- Sound can be detected by placing the ear against the screw driver handle while putting the screw driver to the linear expansion valve.

### (3) How to attach and detach the coil of linear expansion valve

<Composition>

Linear expansion valve is separable into the main body and the coil as shown in the diagram below.

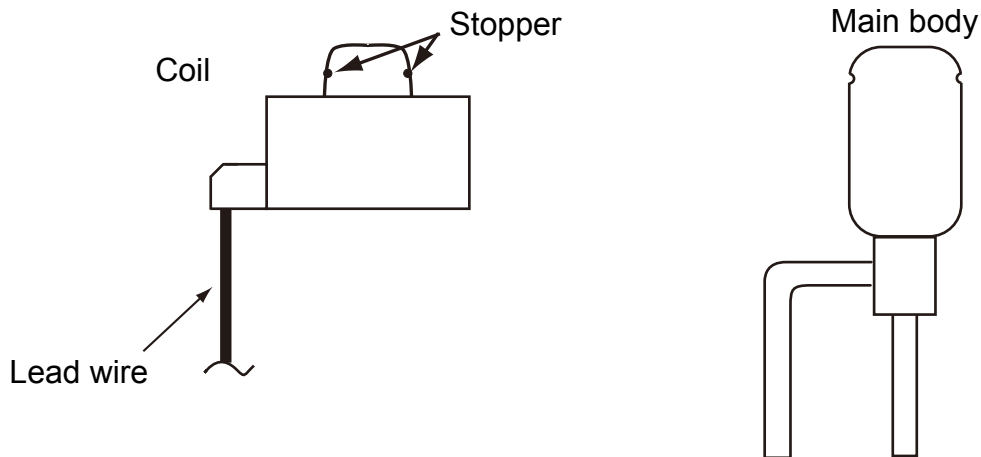

#### <How to detach the coil>

Hold the lower part of the main body (shown as A) firmly so that the main body does not move and detach the coil by pulling it upward.

Be sure to detach the coil holding main body firmly. Otherwise pipes can bend due to pressure.

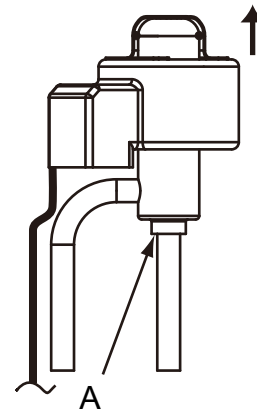

#### <How to attach the coil>

Hold the lower part of the main body (shown as A) firmly so that the main body does not move and attach the coil by inserting it downward into the main body. Then securely attach the coil stopper to main body. (At this time, be careful that stress is not added to lead wire and main body is not wound by lead wire.) If the stopper is not firmly attached to main body, coil may be detached from the main body and that can cause defective operation of linear expansion valve.

To prevent piping stress, be sure to attach the coil holding the main body of linear expansion valve firmly. Otherwise pipe may break.

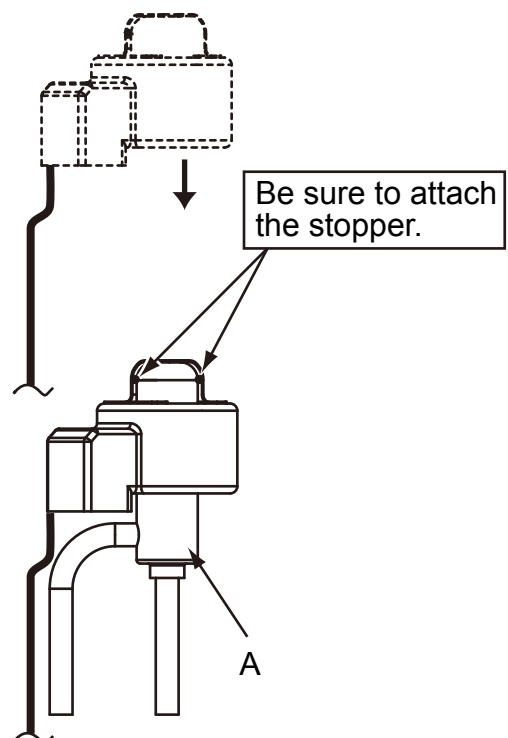

# 10-6. TEST POINT DIAGRAM

Outdoor controller circuit board  
 PUHZ-SW160YKA.UK  
 PUHZ-SW160YKA-BS.UK  
 PUHZ-SW160YKAR1.UK  
 PUHZ-SW160YKAR1-BS.UK

PUHZ-SW200YKA.UK  
 PUHZ-SW200YKA-BS.UK  
 PUHZ-SW200YKAR1.UK  
 PUHZ-SW200YKAR1-BS.UK

<CAUTION> TEST POINT ① is high voltage.

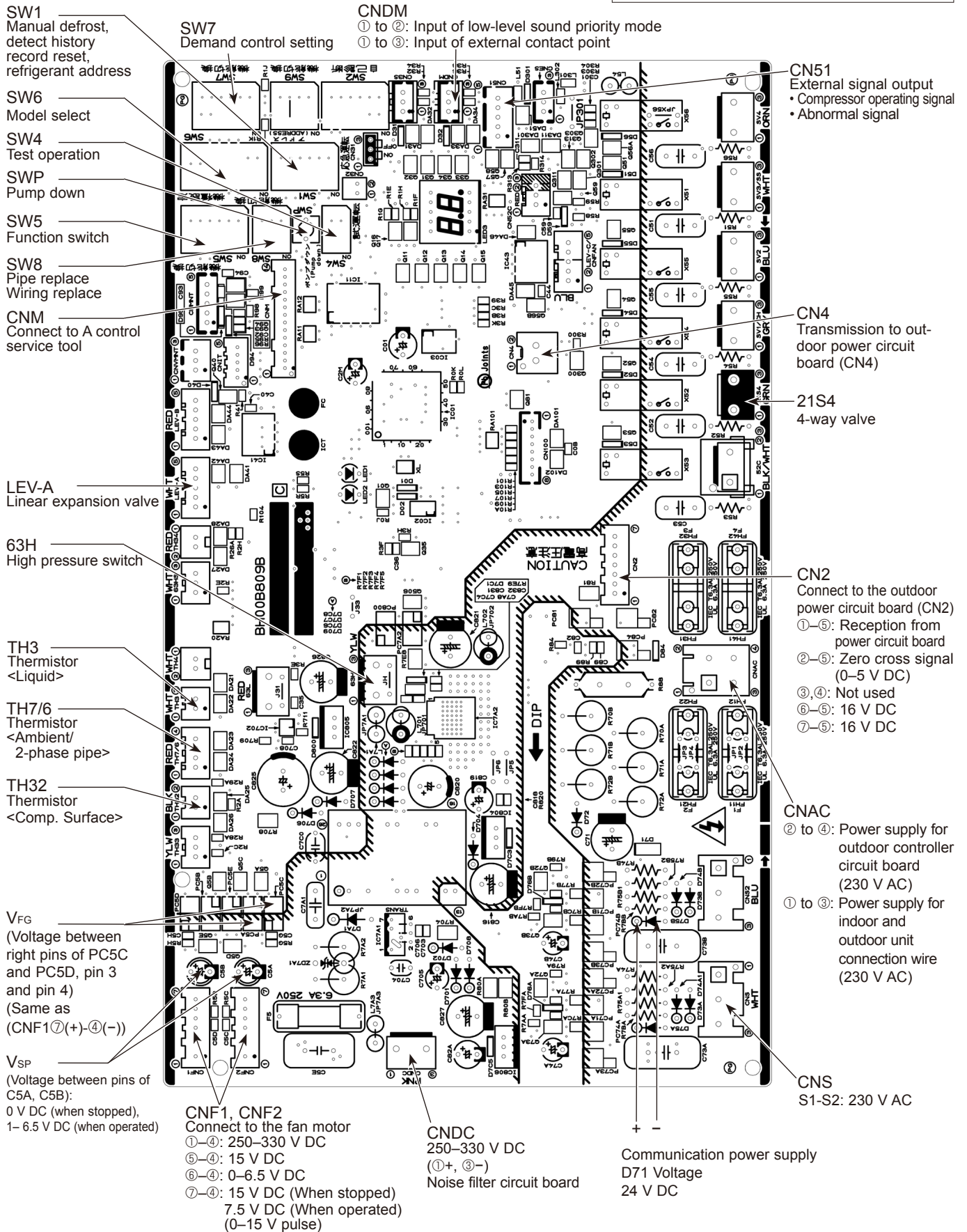



**Outdoor noise filter circuit board**

**PUHZ-SW160YKA.UK**

**PUHZ-SW160YKA-BS.UK**

**PUHZ-SW160YKAR1.UK**

**PUHZ-SW160YKAR1-BS.UK**

**PUHZ-SW200YKA.UK**

**PUHZ-SW200YKA-BS.UK**

**PUHZ-SW200YKAR1.UK**

**PUHZ-SW200YKAR1-BS.UK**

L11, L12, L13, NI  
 POWER SUPPLY  
 L11-L12/L1-LI3/LI3-LI1 : 400 V AC input  
 L11-NI/LI2-NI/LI3-NI : 230 V AC input  
 (Connect to the terminal block (TB1))

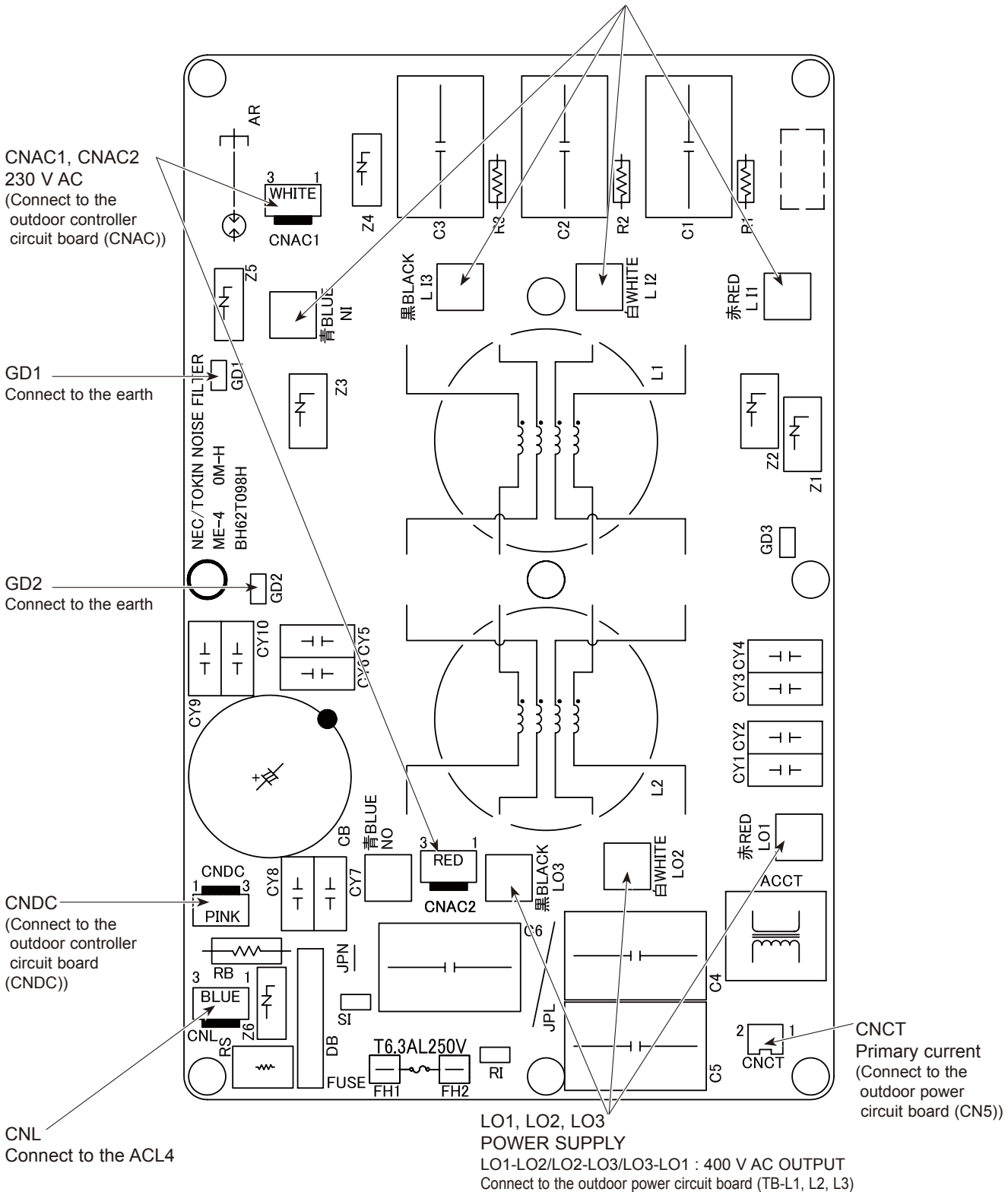

**Outdoor power circuit board**  
**PUHZ-SW160YKA.UK**  
**PUHZ-SW160YKAR1.UK**  
**PUHZ-SW200YKA.UK**  
**PUHZ-SW200YKAR1.UK**  
**PUHZ-SW160YKA-BS.UK**  
**PUHZ-SW160YKAR1-BS.UK**  
**PUHZ-SW200YKA-BS.UK**  
**PUHZ-SW200YKAR1-BS.UK**

**Brief Check of POWER MODULE**

Usually, they are in a state of being short-circuited if they are broken. Measure the resistance in the following points (connectors, etc.). If they are short-circuited, it means that they are broken.

1. Check of DIODE MODULE

L1 - P1, L2 - P1, L3 - P1, L1 - N1, L2 - N1, L3 - N1

2. Check of DIP-IPM

P2 - U, P2 - V, P2 - W, N2 - U, N2 - V, N2 - W

Note: The marks L1, L2, L3, N1, N2, P1, P2, U, V and W shown in the diagram are not actually printed on the board.

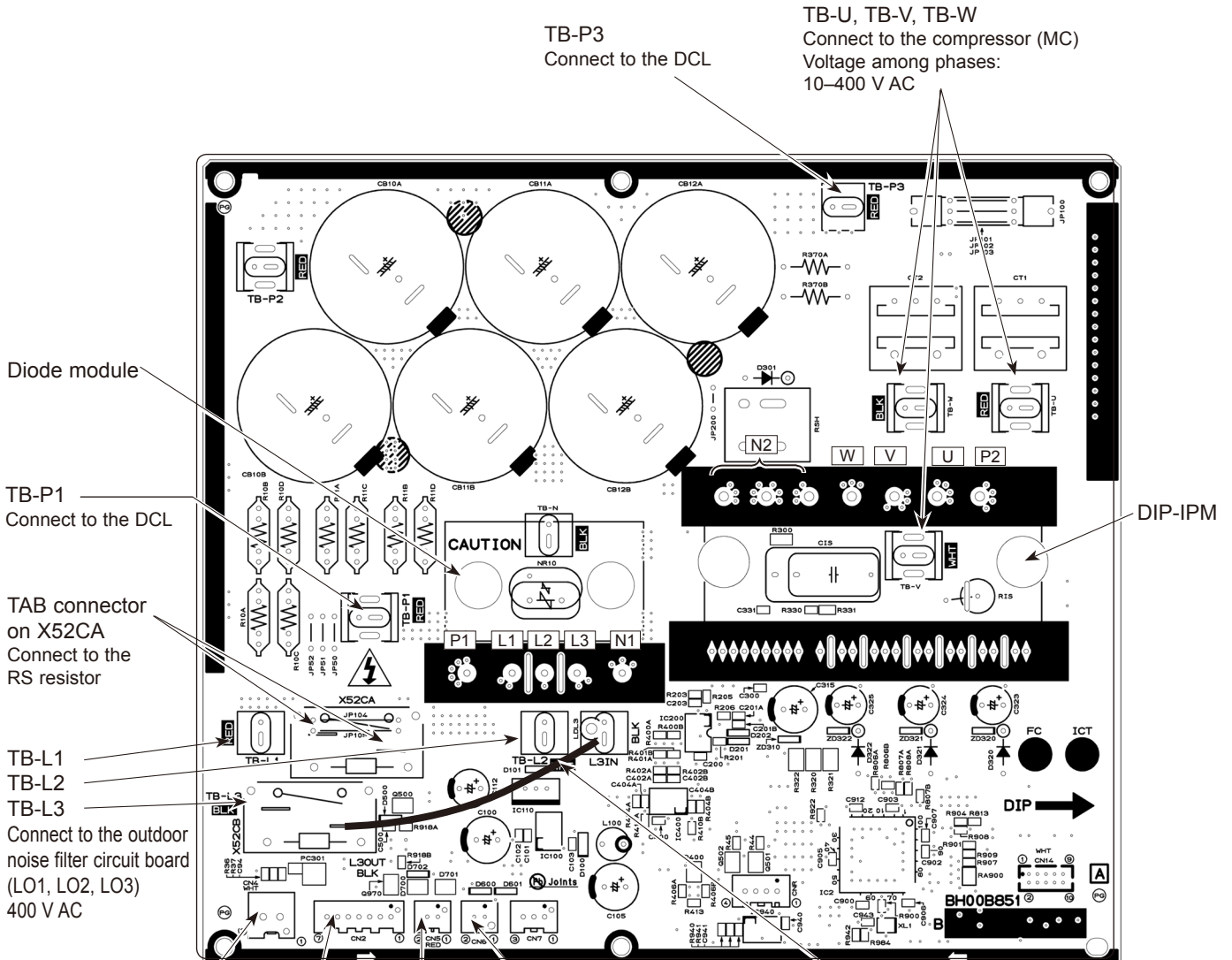

Diode module

TB-P1  
Connect to the DCL

TAB connector on X52CA  
Connect to the RS resistor

TB-L1  
TB-L2  
TB-L3  
Connect to the outdoor noise filter circuit board (LO1, LO2, LO3)  
400 V AC

CN4  
Connect to the outdoor controller circuit board (CN4)

CN2  
Connect to the outdoor controller circuit board (CN2)

- ①-⑤: Power circuit board → Transmitting signal to the controller board (0-5 V DC)
- ②-⑤: Zero cross signal (0-5 V DC)
- ③-④: Not used
- ⑥-⑤: 16 V DC
- ⑦-⑤: 16 V DC

CN5  
Detection of primary current (Connect to the outdoor noise filter circuit board (CNCT))

CN6  
Thermistor <Heat sink> (TH8)

L3OUT-L3IN  
Lead connect

TB-P3  
Connect to the DCL

TB-U, TB-V, TB-W  
Connect to the compressor (MC)  
Voltage among phases:  
10-400 V AC

DIP-IPM

## 10-7. FUNCTION OF SWITCHES, CONNECTORS AND JUMPERS

### (1) Function of switches

The black square (■) indicates a switch position.

Type of Switch	Switch	No.	Function	Action by the switch operation		Default setting	Effective timing																					
				ON	OFF																							
DIP switch	SW1	1	Manual defrost *1	Start	Normal	OFF	When compressor is working in heating operation. *1																					
		2	Abnormal history clear	Clear	Normal	OFF	off or operating																					
		3	Refrigerant address setting			OFF	When power supply is ON																					
		4																										
		5																										
		6																										
	SW4	1	No function	—	—	OFF	—																					
2		No function	—	—	OFF	—																						
Push switch	SWP		Pump down	Start	Normal	—	Under suspension																					
DIP switch	SW5	1	No function	—	—	OFF	—																					
		2	Power failure automatic recovery *2	Auto recovery	No auto recovery	OFF	When power supply ON																					
		3,4,5	No function	—	—	OFF	—																					
		6	Model select	Following SW5-6 reference		—	—																					
	SW7*4	1	Mode select *3	Demand function	Low noise mode	OFF	Always																					
		2	No function	—	—	OFF	—																					
		3	Max Hz setting (cooling)	Max Hz (cooling) × 0.8	Normal	OFF	Always																					
		4	Max Hz setting (heating)	Max Hz (heating) × 0.8	Normal	OFF	Always																					
		5	No function	—	—	OFF	—																					
		6	Defrost setting	For high humidity	Normal	OFF	Always																					
	SW8	1	No function	—	—	OFF	—																					
		2	No function	—	—	OFF	—																					
		3	No function	—	—	OFF	—																					
	SW9	1	No function	—	—	OFF	—																					
		2	No function	—	—	OFF	—																					
		3,4	No function	—	—	OFF	—																					
	SW6	1	Model select	The black square (■) indicates a switch position.		As shown in the left table	—																					
		2		<table border="1"> <thead> <tr> <th>MODEL</th> <th>SW6</th> <th>SW5-6 *5</th> </tr> </thead> <tbody> <tr> <td rowspan="2">PUHZ-SW160YKA</td> <td>ON OFF</td> <td></td> <td>ON OFF</td> <td></td> </tr> <tr> <td></td> <td></td> <td></td> <td></td> </tr> <tr> <td rowspan="2">PUHZ-SW200YKA</td> <td>ON OFF</td> <td></td> <td>ON OFF</td> <td></td> </tr> <tr> <td></td> <td></td> <td></td> <td></td> </tr> </tbody> </table>				MODEL	SW6	SW5-6 *5	PUHZ-SW160YKA	ON OFF		ON OFF						PUHZ-SW200YKA	ON OFF		ON OFF					
		MODEL		SW6	SW5-6 *5																							
		PUHZ-SW160YKA		ON OFF				ON OFF																				
PUHZ-SW200YKA		ON OFF			ON OFF																							
3																												
4																												
5																												
6																												
7																												
8																												
SW5	6																											

\*1 Manual defrost should be done as follows.

① Change the DIP SW1-1 on the outdoor controller board from OFF to ON.

② Manual defrost will start by the above operation ① if all these conditions written below are satisfied.

- Heat mode setting
- 10 minutes have passed since compressor started operating or previous manual defrost is finished.
- Pipe temperature is less than or equal to 8°C.

Manual defrost will finish if certain conditions are satisfied.

Manual defrost can be done if above conditions are satisfied when DIP SW1-1 is changed from OFF to ON.

After DIP SW1-1 is changed from OFF to ON, there is no problem if DIP SW1-1 is left ON or changed to OFF again.

This depends on the service conditions.

\*2 'Power failure automatic recovery' can be set by either remote controller or this DIP SW. If one of them is set to ON, 'Auto recovery' activates. Please set "Auto recovery" basically by remote controller because all units do not have DIP SW.

Please refer to the indoor unit installation manual.

\*3 SW7-1 is setting change over of Demand/Low noise. It is effective only in case of external input.

(Local wiring is necessary. Refer to the next page: Special function)

\*4 Please do not use SW7-3 to 7-6 usually. Trouble might be caused by the usage condition.

\*5 SW5-1 to 5: Function switch

## Special function

### (a) Low-level sound priority mode (Local wiring)

By performing the following modification, operation noise of the outdoor unit can be reduced by about 3-4 dB.

The low noise mode will be activated when a commercially available timer or the contact input of an ON/OFF switch is added to the CNDM connector (option) on the control board of the outdoor unit.

• The ability varies according to the outdoor temperature and conditions, etc.

① Complete the circuit as shown when using the external input adapter (PAC-SC36NA-E). (Option)

② SW7-1 (Outdoor unit control board): OFF

③ SW1 ON: Low noise mode

SW1 OFF: Normal operation

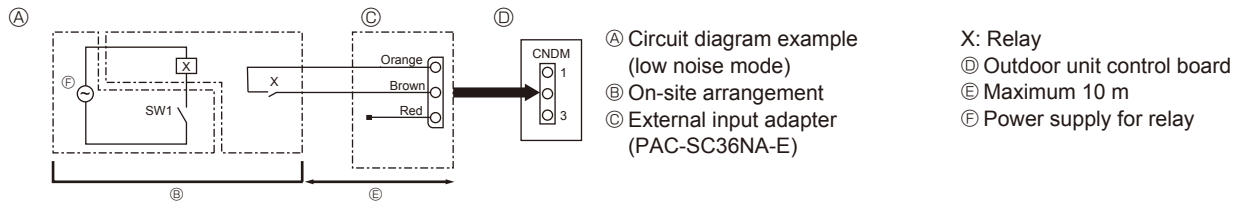

**<Display function of inspection for outdoor unit>**

The blinking patterns of both LED1 (green) and LED2 (red) indicate the types of abnormality when it occurs. Types of abnormality can be indicated in details by connecting an optional part 'A-Control Service Tool (PAC-SK52ST)' to connector CNM on outdoor controller board.

[Display]

(1)Normal condition

Unit condition	Outdoor controller board		A-Control Service Tool	
	LED1 (Green)	LED2 (Red)	Check code	Indication of the display
When the power is turned on	Lighted	Lighted	— ⇄ —	Alternately blinking display
When unit stops	Lighted	Not lighted	00, etc.	Operation mode
When compressor is warming up	Lighted	Not lighted	08, etc.	
When unit operates	Lighted	Lighted	C5, H7, etc.	

(2)Abnormal condition

Indication		Error			
Outdoor controller board		Contents	Check code *1	Inspection method	Detailed reference page
LED1 (Green)	LED2 (Red)				
1 blinking	2 blinking	Connector (63H) is open.	F5	①Check if connector (63H) on the outdoor controller board is not disconnected. ②Check continuity of pressure switch (63H) by a tester.	P.18
2 blinking	1 blinking	Miswiring of indoor/outdoor unit connecting wire, excessive number of indoor units (4 units or more)	—	①Check if indoor/outdoor connecting wire is connected correctly. ②Check if 4 or more indoor units are connected to outdoor unit.	P.19 (EA)
		Miswiring of indoor/outdoor unit connecting wire (converse wiring or disconnection)	—	③Check if noise entered into indoor/outdoor connecting wire or power supply. ④Re-check error by turning off power, and on again.	P.19 (Eb) P.19 (EC)
		Startup time over	—		
	2 blinking	Indoor/outdoor unit communication error (signal receiving error) is detected by indoor unit.	E6	①Check if indoor/outdoor connecting wire is connected correctly. ②Check if noise entered into indoor/outdoor connecting wire or power supply.	P.25
			E7	③Check if noise entered into indoor/outdoor controller board. ④Re-check error by turning off power, and on again.	P.25
		Indoor/outdoor unit communication error (transmitting error) is detected by indoor unit.	—		P.25 (E8)
		Indoor/outdoor unit communication error (signal receiving error) is detected by outdoor unit.	—		P.26 (E9)
	3 blinking	Remote controller signal receiving error is detected by remote controller.	E0	①Check if connecting wire of indoor unit, or remote controller is connected correctly.	P.24
		Remote controller transmitting error is detected by remote controller.	E3	②Check if noise entered into transmission wire of remote controller. ③Re-check error by turning off power, and on again.	P.25
		Remote controller signal receiving error is detected by indoor unit.	E4		P.24
Remote controller transmitting error is detected by indoor unit.		E5		P.25	
4 blinking	Check code is not defined.	EF	①Check if the remote controller is compatible. ②Check if noise entered into transmission wire of remote controller. ③Check if noise entered into indoor/outdoor connecting wire. ④Re-check error by turning off power, and on again.	P.26	
		PL	①Be sure to replace the 4-way valve. ②Check refrigerant pipes for disconnection or leakage. ③After the recovery of refrigerant, vacuum dry the whole refrigerant circuit. ④Check refrigerant circuit for operation.	P.26	
5 blinking	Serial communication error <Communication between outdoor controller board and outdoor power board>	Ed	①Check if connector (CN4) on outdoor controller board and outdoor power board is not disconnected.	P.26	

\*1 Check code displayed on remote controller

\*2 Refer to the service manual of indoor unit.



Indication		Error			
Outdoor controller board		Contents	Check code *1	Inspection method	Detailed reference page
LED1 (Green)	LED2 (Red)				
3 blinking	1 blinking	Abnormality of comp. surface thermistor(TH32)	U2	①Check if stop valves are open. ②Check if connectors (TH32 and LEV-A) on outdoor controller board are not disconnected. ③Check if unit is filled with specified amount of refrigerant. ④Measure resistance values among terminals on indoor valve and outdoor linear expansion valve using a tester.	P.20
	2 blinking	Abnormal high pressure (High pressure switch 63H operated.)	U1	①Check if indoor/outdoor units have a short cycle on their air ducts. ②Check if connector (63H) on outdoor controller board is not disconnected. ③Check if heat exchanger and filter is not dirty. ④Measure resistance values among terminals on linear expansion valve using a tester.	P.20
	3 blinking	Abnormality of outdoor fan motor rotational speed	U8	①Check the outdoor fan motor. ②Check if connector (TH3) on outdoor controller board is disconnected.	P.21
		Protection from overheat operation(TH3)	Ud		P.23
	4 blinking	Compressor overcurrent breaking(Start-up locked)	UF	①Check if stop valves are open. ②Check looseness, disconnection, and converse connection of compressor wiring. ③Measure resistance values among terminals on compressor using a tester. ④Check if outdoor unit has a short cycle on its air duct. ⑤Check leakage of refrigerant.	P.23
		Compressor overcurrent breaking	UP		P.24
		Abnormality of current sensor (P.B.)	UH		P.23
		Abnormality of power module	U6		P.21
	5 blinking	Open/short of comp. surface thermistor (TH32)	U3	①Check if connectors(TH3, TH6, TH7 and TH32)on outdoor controller board and connector (CN3) on outdoor power board are not disconnected. ②Measure resistance value of outdoor thermistors.	P.20
		Open/short of outdoor thermistors (TH3, TH6, TH7 and TH8)	U4		P.21
6 blinking	Abnormality of heat sink temperature	U5	①Check if indoor/outdoor units have a short cycle on their air ducts. ②Measure resistance value of outdoor thermistor(TH8).	P.21	
7 blinking	Abnormality of voltage	U9	①Check looseness, disconnection, and converse connection of compressor wiring. ②Measure resistance value among terminals on compressor using a tester. ③Check if power supply voltage decreases. ④Check the wiring of CN52C.	P.22	
4 blinking	1 blinking	Abnormality of room temperature thermistor (TH1)	P1	①Check if connectors or terminal blocks on indoor controller board are not disconnected. ②Measure resistance value of indoor thermistors.	*2
		Abnormality of pipe temperature thermistor /Liquid (TH2)	P2		*2
		Abnormality of pipe temperature thermistor/condenser-evaporator/ or tank water temperature thermistor	P9		*2
	2 blinking	Abnormality of drain sensor (DS) Float switch(FS) connector open	P4	①Check if connectors or terminal blocks on indoor controller board is not disconnected. ②Measure resistance value of indoor thermistors. ③Measure resistance value among terminals on drain pump using a tester. ④Check if drain pump works. ⑤Check drain function.	*2
		Indoor drain overflow protection	P5		
	3 blinking	Freezing (cooling)/overheating (heating) protection	P6	①Check if indoor unit has a short cycle on its air duct. ②Check if heat exchanger and filter is not dirty. ③Measure resistance value on indoor and outdoor fan motors. ④Check if the inside of refrigerant piping is not clogged.	*2

\*1 Check code displayed on remote controller  
\*2 Refer to the service manual of indoor unit.

**<Outdoor unit operation monitor function>**

**[When optional part 'A-Control Service Tool (PAC-SK52ST)' is connected to outdoor controller board (CNM)]**

Digital indicator LED1 displays 2 digit number or code to inform operation condition and the meaning of check code by controlling DIP SW2 on 'A-Control Service Tool'.

Operation indicator SW2 : Indicator change of self diagnosis

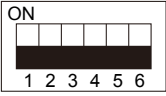
SW2 setting	Display detail	Explanation for display	Unit
			

**<Digital indicator LED1 working details>**

(Be sure that the 1 to 6 in the SW2 are set to OFF.)

(1) Display when the power supply ON

When the power supply ON, blinking displays by turns.  
Wait for 4 minutes at the longest.

(2) When the display lights (Normal operation)

① Operation mode display.

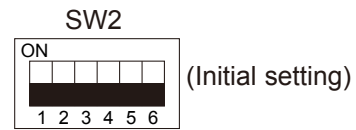
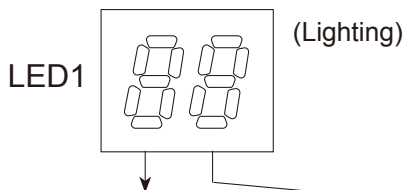
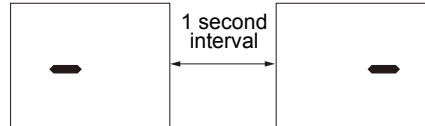

The tens digit : Operation mode

Display	Operation Model
O	OFF / FAN
C	COOLING
H	HEATING
d	DEFROSTING

The ones digit : Relay output

Display	Warming-up Compressor	Compressor	4-way valve	Solenoid valve
0	—	—	—	—
1	—	—	—	ON
2	—	—	ON	—
3	—	—	ON	ON
4	—	ON	—	—
5	—	ON	—	ON
6	—	ON	ON	—
7	—	ON	ON	ON
8	ON	—	—	—
A	ON	—	ON	—

② Display during error postponement

Postponement code is displayed when compressor stops due to the work of protection device.

Postponement code is displayed while error is being postponed.

(3) When the display blinks

Inspection code is displayed when compressor stops due to the work of protection devices.

Display	Contents to be inspected (During operation)
U1	Abnormal high pressure (63H operated)
U2	Abnormal high discharge temperature and comp. surface thermistor, shortage of refrigerant
U3	Open/short circuit of comp. surface thermistor(TH32)
U4	Open/short of outdoor unit thermistors (TH3, TH6, TH7 and TH8)
U5	Abnormal temperature of heat sink
U6	Abnormality of power module
U8	Abnormality in outdoor fan motor
Ud	Overheat protection
UF	Compressor overcurrent interruption (When Comp. locked)
UH	Current sensor error
UL	Abnormal low pressure
UP	Compressor overcurrent interruption
PL	Abnormality of refrigerant
P1-P8	Abnormality of indoor units

Display	Inspection unit
0	Outdoor unit
1	Indoor unit 1



Display	Contents to be inspected (When power is turned on)
F5	63H connector(yellow) is open.
E8	Indoor/outdoor communication error (Signal receiving error) (Outdoor unit)
E9	Indoor/outdoor communication error (Transmitting error) (Outdoor unit)
EA	Miswiring of indoor/outdoor unit connecting wire, excessive number of indoor units (4 units or more)
Eb	Miswiring of indoor/outdoor unit connecting wire(converse wiring or disconnection)
EC	Startup time over
E0-E7	Communication error except for outdoor unit

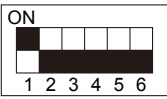
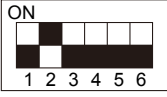
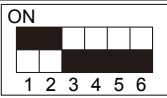
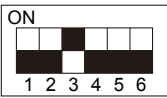
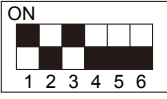
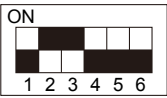
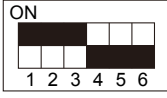
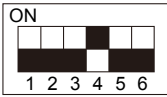
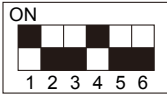
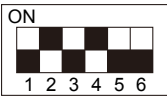
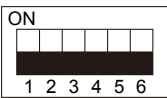

The black square (■) indicates a switch position.

SW2 setting	Display detail	Explanation for display	Unit
	Pipe temperature/Liquid (TH3) -40 to 90	-40 to 90 (When the coil thermistor detects 0°C or below, “-” and temperature are displayed by turns.) (Example) When -10°C; 0.5 s    0.5 s    2 s -□    → 10    → □□ ↑	°C
	Comp. surface temperature (TH32) -52 to 221	-52 to 221 (When the discharge thermistor detects 100°C or more, hundreds digit, tens digit and ones digit are displayed by turns.) (Example) When 105°C; 0.5 s    0.5 s    2 s □1    → 05    → □□ ↑	°C
	Output step of outdoor FAN 0 to 10	0 to 10	Step
	The number of ON / OFF times of compressor 0 to 9999	0 to 9999 (When the number of times is 100 or more, hundreds digit, tens digit and ones digit are displayed by turns.) (Example) When 42500 times (425 × 100 times); 0.5 s    0.5 s    2 s □4    → 25    → □□ ↑	100 times
	Compressor integrating operation times 0 to 9999	0 to 9999 (When it is 100 hours or more, hundreds digit, tens digit and ones digit are displayed by turns.) (Example) When 2450 hours (245 × 10 hours); 0.5 s    0.5 s    2 s □2    → 45    → □□ ↑	10 hours
	Compressor operating current 0 to 50	0 to 50 (Omit the figures after the decimal fractions.)	A
	Compressor operating frequency 0 to 255	0 to 255 (When it is 100Hz or more, hundreds digit, tens digit and ones digit are displayed by turns.) (Example) When 125Hz; 0.5 s    0.5 s    2 s □1    → 25    → □□ ↑	Hz
	LEV-A opening pulse 0 to 480	0 to 480 (When it is 100 pulse or more, hundreds digit, tens digit and ones digit are displayed by turns.) (Example) When 150 pulse; 0.5 s    0.5 s    2 s □1    → 50    → □□ ↑	Pulse
	Error postponement code history (1) of outdoor unit	Postponement code display Blinking: During postponement Lighting: Cancellation of postponement “00” is displayed in case of no postponement.	Code display
	Operation mode on error occurring	Operation mode of when operation stops due to error is displayed by setting SW2 like below.  (SW2) 	Code display

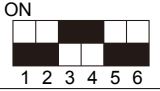
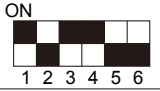
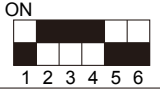
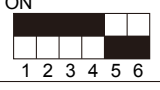
The black square (■) indicates a switch position.

SW2 setting	Display detail	Explanation for display	Unit
	Pipe temperature/Liquid (TH3) on error occurring -40 to 90	-40 to 90 (When the coil thermistor detects 0°C or below, “-” and temperature are displayed by turns.) (Example) When -15°C; 0.5 s      0.5 s      2 s -□      → 15      → □□ ↑ └──────────────────┘	°C
	Comp. surface temperature (TH32) on error occurring -52 to 221	-52 to 221 (When the temperature is 100°C or more, the hundreds digit, tens digit and ones digit are displayed by turns.) (Example) When 130°C; 0.5 s      0.5 s      2 s □1      → 30      → □□ ↑ └──────────────────┘	°C
	Compressor operating current on error occurring 0 to 50	0 to 50	A
	Error history (1) (latest) Alternate display of abnormal unit number and code	When no error history, “0” and “-” are displayed by turns.	Code display
	Error history (2) Alternate display of error unit number and code	When no error history, “0” and “-” are displayed by turns.	Code display
	Thermostat ON time 0 to 999	0 to 999 (When it is 100 minutes or more, the hundreds digit, tens digit and ones digit are displayed by turns.) (Example) When 245 minutes; 0.5 s      0.5 s      2 s □2      → 45      → □□ ↑ └──────────────────┘	Minute
	Test run elapsed time 0 to 120	0 to 120 (When it is 100 minutes or more, the hundreds digit, tens digit and ones digit are displayed by turns.) (Example) When 105 minutes; 0.5 s      0.5 s      2 s □1      → 05      → □□ ↑ └──────────────────┘	Minute

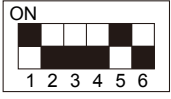
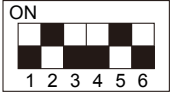
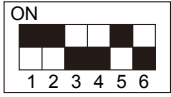
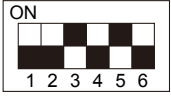
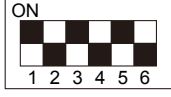
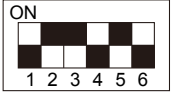
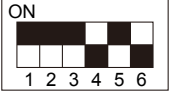
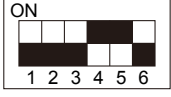

The black square (■) indicates a switch position.

SW2 setting	Display detail	Explanation for display	Unit										
	The number of connected indoor units	0 to 4 (The number of connected indoor units are displayed.)	Unit										
	Capacity setting display	Displayed as an outdoor capacity code. <table border="1" data-bbox="833 510 1289 607"> <thead> <tr> <th>Capacity</th> <th>Code</th> </tr> </thead> <tbody> <tr> <td>SW160YKA</td> <td>40</td> </tr> <tr> <td>SW200YKA</td> <td>50</td> </tr> </tbody> </table>	Capacity	Code	SW160YKA	40	SW200YKA	50	Code display				
Capacity	Code												
SW160YKA	40												
SW200YKA	50												
	Outdoor unit setting information	<ul style="list-style-type: none"> <li>The tens digit (Total display for applied setting)</li> </ul> <table border="1" data-bbox="821 757 1396 880"> <thead> <tr> <th>Setting details</th> <th>Display details</th> </tr> </thead> <tbody> <tr> <td>H·P / Cooling only</td> <td>0 : H·P      1 : Cooling only</td> </tr> <tr> <td>Single phase / 3 phase</td> <td>0 : Single phase   2 : 3 phase</td> </tr> </tbody> </table> <ul style="list-style-type: none"> <li>The ones digit</li> </ul> <table border="1" data-bbox="821 936 1396 1014"> <thead> <tr> <th>Setting details</th> <th>Display details</th> </tr> </thead> <tbody> <tr> <td>Defrosting switch</td> <td>0 : Normal    1 : For high humidity</td> </tr> </tbody> </table> <p>(Example) When heat pump, 3 phase and defrosting (normal) are set up, "20" is displayed.</p>	Setting details	Display details	H·P / Cooling only	0 : H·P      1 : Cooling only	Single phase / 3 phase	0 : Single phase   2 : 3 phase	Setting details	Display details	Defrosting switch	0 : Normal    1 : For high humidity	Code display
Setting details	Display details												
H·P / Cooling only	0 : H·P      1 : Cooling only												
Single phase / 3 phase	0 : Single phase   2 : 3 phase												
Setting details	Display details												
Defrosting switch	0 : Normal    1 : For high humidity												
	Indoor pipe temperature/Liquid (TH2(1)) Indoor 1 -39 to 88	-39 to 88 (When the temperature is 0°C or less, "-" and temperature are displayed by turns.)	°C										
	Indoor pipe temperature/Cond./Eva. (TH5(1)) Indoor 1 -39 to 88	-39 to 88 (When the temperature is 0°C or less, "-" and temperature are displayed by turns.)	°C										
	Indoor pipe temperature/Liquid (TH2(2)) Indoor 2 -39 to 88	-39 to 88 (When the temperature is 0°C or less, "-" and temperature are displayed by turns.)	°C										
	Indoor pipe temperature/Cond. / Eva. (TH5(2)) Indoor 2 -39 to 88	-39 to 88 (When the temperature is 0°C or less, "-" and temperature are displayed by turns.)	°C										
	Indoor room temperature (TH1) 8 to 39	8 to 39	°C										

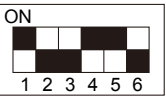
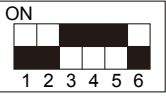
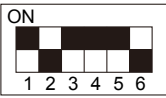
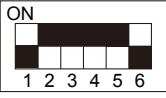
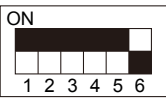
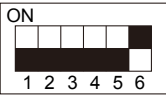
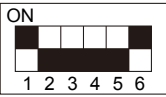
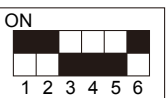
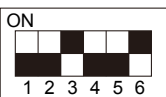
The black square (■) indicates a switch position.

SW2 setting	Display detail	Explanation for display	Unit														
	Indoor setting temperature 17 to 30	17 to 30	°C														
	Outdoor pipe temperature/2-phase (TH6) -39 to 88	-39 to 88 (When the temperature is 0°C or less, “-” and temperature are displayed by turns.)	°C														
	Outdoor Ambient temperature (TH7) -39 to 88	-39 to 88 (When the temperature is 0°C or less, “-” and temperature are displayed by turns.)	°C														
	Outdoor Heat sink temperature (TH8) -40 to 200	-40 to 200 (When the temperature is 0°C or less, “-” and temperature are displayed by turns.) (When the thermistor detects 100°C or more, hundreds digit, tens digit and ones digit are displayed by turns.)	°C														
	Discharge superheat SHd 0 to 255 [ Cooling = TH32-T <sub>63HS</sub> ] [ Heating = TH32-T <sub>63HS</sub> ]	0 to 255 (When the temperature is 100°C or more, hundreds digit, tens digit and ones digit are displayed by turns.)	°C														
	Number of defrost cycles 0 to FFFE	0 to FFFE (in hexadecimal notation) (When more than FF in hex (255 in decimal), the number is displayed in order of 16 <sup>3</sup> 's and 16 <sup>2</sup> 's, and 16 <sup>1</sup> 's and 16 <sup>0</sup> 's places. (Example) When 5000 cycles; 0.5 s    0.5 s    2 s □9 → C4 → □□	2 cycles														
	Input current of outdoor unit	0 to 500 (When it is 100 or more, hundreds digit, tens digit and ones digit are displayed by turns.)	0.1 A														
	U9 error detail history (latest)	<table border="1" data-bbox="753 1505 1259 1691"> <thead> <tr> <th>Description</th> <th>Display</th> </tr> </thead> <tbody> <tr> <td>Normal</td> <td>00</td> </tr> <tr> <td>Overvoltage error</td> <td>01</td> </tr> <tr> <td>Undervoltage error</td> <td>02</td> </tr> <tr> <td>Input current sensor error</td> <td>04</td> </tr> <tr> <td>L-phase open error</td> <td>04</td> </tr> <tr> <td>Abnormal power synchronous signal</td> <td>08</td> </tr> </tbody> </table> <p>Display examples for multiple errors: Overvoltage (01) + Undervoltage (02) = 03 Undervoltage (02) + Power-sync signal error (08) = 0A</p>	Description	Display	Normal	00	Overvoltage error	01	Undervoltage error	02	Input current sensor error	04	L-phase open error	04	Abnormal power synchronous signal	08	Code display
Description	Display																
Normal	00																
Overvoltage error	01																
Undervoltage error	02																
Input current sensor error	04																
L-phase open error	04																
Abnormal power synchronous signal	08																
	DC bus voltage 300 to 750	300 to 750 (When it is 100 V or more, hundreds digit, tens digit and ones digit are displayed by turns.)	V														

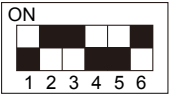
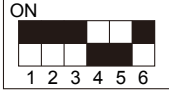
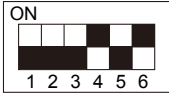

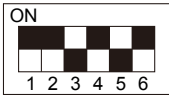
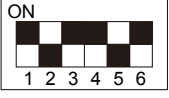
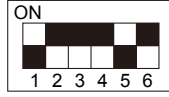
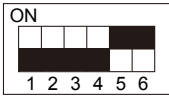
The black square (■) indicates a switch position.

SW2 setting	Display detail	Explanation for display	Unit
	Error postponement code history (2) of outdoor unit	Postponement code display Blinking: During postponement Lighting: Cancellation of postponement "00" is displayed in case of no postponement.	Code display
	Error postponement code history (3) of outdoor unit	Postponement code display Blinking: During postponement Lighting: Cancellation of postponement "00" is displayed in case of no postponement.	Code display
	Error history (3) (Oldest) Alternate display of abnormal unit number and code.	When no error history, "0" and "--" are displayed by turns.	Code display
	Error thermistor display [When there is no error thermistor, "--" is displayed.]	3: Outdoor pipe temperature /Liquid (TH3) 6: Outdoor pipe temperature /2-phase (TH6) 7: Outdoor Ambient temperature (TH7) 8: Outdoor Heat sink (TH8)	Code display
	Operation frequency on error occurring 0 to 255	0 to 255 (When it is 100Hz or more, hundreds digit, tens digit and ones digit are displayed by turns.) (Example) When 125Hz; <div style="text-align: center;">           0.5 s      0.5 s      2 s            □1      → 25      → □□            ↑         </div>	Hz
	Fan step on error occurring 0 to 10	0 to 10	Step
	Indoor room temperature (TH1) on error occurring 8 to 39	8 to 39	°C
	Indoor pipe temperature/Liquid (TH2) on error occurring -39 to 88	-39 to 88 (When the temperature is 0°C or less, "--" and temperature are displayed by turns.) (Example) When -15°C; <div style="text-align: center;">           0.5 s      0.5 s      2 s            -□      → 15      → □□            ↑         </div>	°C
	Outdoor temperature/2-phase pipe (TH6) on error occurring -39 to 88	-39 to 88 (When the temperature is 0°C or less, "--" and temperature are displayed by turns.) (Example) When -15°C; <div style="text-align: center;">           0.5 s      0.5 s      2 s            -□      → 15      → □□            ↑         </div>	°C

The black square (■) indicates a switch position.

SW2 setting	Display detail	Explanation for display	Unit
	Outdoor temperature/Ambient (TH7) on error occurring -39 to 88	-39 to 88 (When the temperature is 0°C or less, “-” and temperature are displayed by turns.) (Example) When -15°C; 0.5 s    0.5 s    2 s -□    → 15    → □□ ↑	°C
	Outdoor temperature/Heat sink (TH8) on error occurring -40 to 200	-40 to 200 (When the temperature is 0°C or less, “-” and temperature are displayed by turns.) (When the temperature is 100°C or more, hundreds digit, tens digit and ones digit are displayed by turns.)	°C
	Discharge superheat on error occurring SHd 0 to 255 [ Cooling = TH32-T <sub>63HS</sub> Heating = TH32-T <sub>63HS</sub> ]	0 to 255 (When the temperature is 100°C or more, hundreds digit, tens digit and ones digit are displayed by turns.) (Example) When 150°C; 0.5 s    0.5 s    2 s □1    → 50    → □□ ↑	°C
	Sub cool on error occurring SC 0 to 130 [ Cooling = T <sub>63HS</sub> -TH3 Heating = T <sub>63HS</sub> -TH2 ]	0 to 130 (When the temperature is 100°C or more, hundreds digit, tens digit and ones digit are displayed by turns.) (Example) When 115°C; 0.5 s    0.5 s    2 s □1    → 15    → □□ ↑	°C
	Thermo-on time until error stops 0 to 999	0 to 999 (When it is 100 minutes or more, hundreds digit, tens digit and ones digit are displayed by turns.) (Example) When 415 minutes; 0.5 s    0.5 s    2 s □4    → 15    → □□ ↑	Minute
	Indoor pipe temperature/ Liquid (TH2 (3)) Indoor 3 -39 to 88	-39 to 88 (When the temperature is 0°C or less, “-” and temperature are displayed by turns.)	°C
	Indoor pipe temperature/ Cond./ Eva. (TH5 (3)) Indoor 3 -39 to 88	-39 to 88 (When the temperature is 0°C or less, “-” and temperature are displayed by turns.)  When there is no indoor unit, “00” is displayed.	°C

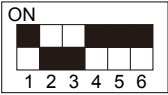
The black square (■) indicates a switch position.

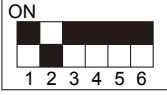
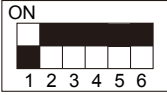
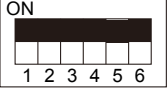
SW2 setting	Display detail	Explanation for display	Unit																
	Controlling status of compressor operating frequency	<p>The following code will be a help to know the operating status of unit.</p> <ul style="list-style-type: none"> <li>•The tens digit</li> </ul> <table border="1" data-bbox="842 383 1289 472"> <thead> <tr> <th>Display</th> <th>Compressor operating frequency control</th> </tr> </thead> <tbody> <tr> <td>1</td> <td>Primary current control</td> </tr> <tr> <td>2</td> <td>Secondary current control</td> </tr> </tbody> </table> <ul style="list-style-type: none"> <li>•The ones digit (In this digit, the total number of activated control is displayed.)</li> </ul> <table border="1" data-bbox="842 544 1289 770"> <thead> <tr> <th>Display</th> <th>Compressor operating frequency control</th> </tr> </thead> <tbody> <tr> <td>1</td> <td>Preventive control for excessive temperature rise of discharge temperature</td> </tr> <tr> <td>2</td> <td>Preventive control for excessive temperature rise of condensing temperature</td> </tr> <tr> <td>4</td> <td>Frosting preventing control</td> </tr> <tr> <td>8</td> <td>Preventive control for excessive temperature rise of heat sink</td> </tr> </tbody> </table> <p>(Example) The following controls are activated.</p> <ul style="list-style-type: none"> <li>• Primary current control</li> <li>• Preventive control for excessive temperature rise of condensing temperature</li> <li>• Preventive control for excessive temperature rise of heat sink</li> </ul> 	Display	Compressor operating frequency control	1	Primary current control	2	Secondary current control	Display	Compressor operating frequency control	1	Preventive control for excessive temperature rise of discharge temperature	2	Preventive control for excessive temperature rise of condensing temperature	4	Frosting preventing control	8	Preventive control for excessive temperature rise of heat sink	Code display
Display	Compressor operating frequency control																		
1	Primary current control																		
2	Secondary current control																		
Display	Compressor operating frequency control																		
1	Preventive control for excessive temperature rise of discharge temperature																		
2	Preventive control for excessive temperature rise of condensing temperature																		
4	Frosting preventing control																		
8	Preventive control for excessive temperature rise of heat sink																		
	Indoor pipe temperature/ Cond./ Eva. (TH5 (4)) -39 to 88	-39 to 88 (When the temperature is 0°C or less, “-” and temperature are displayed by turns.)	°C																
	Time to current limit activates from compressor turns ON. 0 to 180	0 to 180	Second																
	U9 error details	<p>To be shown while error call is deferred.</p> <table border="1" data-bbox="826 1480 1337 1671"> <thead> <tr> <th>Description</th> <th>Display</th> </tr> </thead> <tbody> <tr> <td>Normal</td> <td>00</td> </tr> <tr> <td>Overvoltage error</td> <td>01</td> </tr> <tr> <td>Undervoltage error</td> <td>02</td> </tr> <tr> <td>Input current sensor error</td> <td>04</td> </tr> <tr> <td>L1-phase open error</td> <td>04</td> </tr> <tr> <td>Abnormal power synchronous signal</td> <td>08</td> </tr> </tbody> </table> <p>Display examples for multiple errors: Overvoltage (01) + Undervoltage (02) = 03 Undervoltage (02) + Power-sync signal error (08) = 0A</p>	Description	Display	Normal	00	Overvoltage error	01	Undervoltage error	02	Input current sensor error	04	L1-phase open error	04	Abnormal power synchronous signal	08	Code display		
Description	Display																		
Normal	00																		
Overvoltage error	01																		
Undervoltage error	02																		
Input current sensor error	04																		
L1-phase open error	04																		
Abnormal power synchronous signal	08																		





## 10-8. Request code list

Certain indoor/outdoor combinations do not have the request code function; therefore, no request codes are displayed. Refer to indoor unit service manual for how to use the controllers and request codes for indoor unit.

Request code	Request content	Description (Display range)	Unit	Remarks
0	Operation state	Refer to 10-8-1. Detail Contents in Request Code.	—	
1	Compressor-Operating current (rms)	0-50	A	
2	Compressor-Accumulated operating time	0-9999	10 hours	
3	Compressor-Number of operation times	0-9999	100 times	
4	Comp. surface temperature (TH32)	3-217	°C	
5	Outdoor unit -Liquid pipe 1 temperature (TH3)	-40-90	°C	
6				
7	Outdoor unit: 2-phase pipe temperature (TH6) <cooling> Condensing temperature (T <sub>63HS</sub> ) <heating>	-39-88	°C	
8				
9	Outdoor unit-Outside air temperature (TH7)	-39-88	°C	
10	Outdoor unit-Heat sink temperature (TH8)	-40-200	°C	
11				
12	Discharge superheat (SHd)	0-255	°C	
13	Sub-cool (SC)	0-130	°C	
14				
15				
16	Compressor-Operating frequency	0-255	Hz	
17	Compressor-Target operating frequency	0-255	Hz	
18	Outdoor unit-Fan output step	0-10	Step	
19	Outdoor unit-Fan 1 speed (Only for air conditioners with DC fan motor)	0-9999	rpm	"0" is displayed if the air conditioner is a single-fan type.
20	Outdoor unit-Fan 2 speed (Only for air conditioners with DC fan motor)	0-9999	rpm	
21				
22	LEV (A) opening	0-500	Pulses	
23				
24				
25	Primary current	0-50	A	
26	DC bus voltage	180-370	V	
27				
28				
29				
30				
31				
32				
33				
34				
35				
36				
37				
38				
39				
40				
41				
42				
43				
44				
45				
46				
47				
48	Thermostat ON operating time	0-999	Minutes	
49				



Request code	Request content	Description (Display range)	Unit	Remarks
50			—	
51	Outdoor unit-Control state	Refer to 10-8-1.Detail Contents in Request Code.	—	
52	Compressor-Frequency control state	Refer to 10-8-1.Detail Contents in Request Code.	—	
53	Outdoor unit-Fan control state	Refer to 10-8-1.Detail Contents in Request Code.	—	
54	Actuator output state	Refer to 10-8-1.Detail Contents in Request Code.	—	
55	Error content (U9)	Refer to 10-8-1.Detail Contents in Request Code.	—	
56				
57				
58				
59				
60				
61				
62	External input state (silent mode, etc.)	Refer to 10-8-1.Detail Contents in Request Code.	—	
63				
64				
65				
66				
67				
68				
69				
70	Outdoor unit-Capacity setting display	Refer to 10-8-1.Detail Contents in Request Code.	—	
71	Outdoor unit-Setting information	Refer to 10-8-1.Detail Contents in Request Code.	—	
72				
73			—	
74			—	
75				
76			—	
77			—	
78			—	
79			—	
80			—	
81			—	
82			—	
83				
84				
85				
86				
87				
88				
89				
90	Outdoor unit-Microprocessor version information	Examples) Ver 5.01 → "0501"	Ver	
91	Outdoor unit-Microprocessor version information (sub No.)	Auxiliary information (displayed after version information) Examples) Ver 5.01 A000 → "A000"	—	
92				
93				
94				
95				
96				
97				
98				
99				
100	Outdoor unit - Error postponement history 1 (latest)	Displays postponement code. (" - " is displayed if no postponement code is present)	Code	
101	Outdoor unit - Error postponement history 2 (previous)	Displays postponement code. (" - " is displayed if no postponement code is present)	Code	
102	Outdoor unit - Error postponement history 3 (last but one)	Displays postponement code. (" - " is displayed if no postponement code is present)	Code	



Request code	Request content	Description (Display range)	Unit	Remarks
103	Error history 1 (latest)	Displays error history. ("-" is displayed if no history is present.)	Code	
104	Error history 2 (second to last)	Displays error history. ("-" is displayed if no history is present.)	Code	
105	Error history 3 (third to last)	Displays error history. ("-" is displayed if no history is present.)	Code	
106	Abnormal thermistor display (TH3/TH6/TH7/TH8)	3 : TH3 6 : TH6 7 : TH7 8 : TH8 0 : No thermistor error	Sensor number	
107	Operation mode at time of error	Displayed in the same way as request code "0".	-	
108	Compressor-Operating current at time of error	0-50	A	
109	Compressor-Accumulated operating time at time of error	0-9999	10 hours	
110	Compressor-Number of operation times at time of error	0-9999	100 times	
111	Comp. surface temperature (TH32) at time of error	3-217	°C	
112	Outdoor unit-Liquid pipe 1 temperature (TH3) at time of error	-40-90	°C	
113				
114	Outdoor unit at time of error: 2-phase pipe temperature (TH6) <cooling> Condensing temperature (T <sub>63HS</sub> ) <heating>	-39-88	°C	
115				
116	Outdoor unit-Outside air temperature (TH7) at time of error	-39-88	°C	
117	Outdoor unit-Heat sink temperature (TH8) at time of error	-40-200	°C	
118	Discharge superheat (SHd) at time of error	0-255	°C	
119	Sub-cool (SC) at time of error	0-130	°C	
120	Compressor-Operating frequency at time of error	0-255	Hz	
121	Outdoor unit at time of error • Fan output step	0-10	Step	
122	Outdoor unit at time of error • Fan 1 speed (Only for air conditioners with DC fan)	0-9999	rpm	
123	Outdoor unit at time of error • Fan 2 speed (Only for air conditioners with DC fan)	0-9999	rpm	"0" is displayed if the air conditioner is a single-fan type.
124				
125	LEV (A) opening at time of error	0-500	Pulses	
126				
127				
128				
129				
130	Thermostat ON time until operation stops due to error	0-999	Minutes	

## 10-8-1. Detail Contents in Request Code

### [Operation state] (Request code : "0")

Data display

□ □ C 4

Relay output state

Operation mode

Operation mode

Display	Operation mode
0	STOP • FAN
C	COOL • DRY
H	HEAT
d	DEFROST

Relay output state

Display	Power currently supplied to compressor	Compressor	4-way valve	Solenoid valve
0	—	—	—	—
1				ON
2			ON	
3			ON	ON
4		ON		
5		ON		ON
6		ON	ON	
7		ON	ON	ON
8	ON			
A	ON		ON	

### [Outdoor unit – Control state] (Request code : "51")

Data display				State
0	0	0	0	Normal
0	0	0	1	Preparing for heat operation
0	0	0	2	Defrost

### [Compressor – Frequency control state] (Request code : "52")

Data display

0 0 \* \*

Frequency control state ②

Frequency control state ①

Frequency control state ①

Display	Current limit control
0	No current limit
1	Primary current limit control is ON.
2	Secondary current limit control is ON.

Frequency control state ②

Display	Discharge temperature overheat prevention	Condensation temperature overheat prevention	Anti-freeze protection control	Heat sink temperature overheat prevention
0				
1	Controlled			
2		Controlled		
3	Controlled	Controlled		
4			Controlled	
5	Controlled		Controlled	
6		Controlled	Controlled	
7	Controlled	Controlled	Controlled	
8				Controlled
9	Controlled			Controlled
A		Controlled		Controlled
b	Controlled	Controlled		Controlled
C			Controlled	Controlled
d	Controlled		Controlled	Controlled
E		Controlled	Controlled	Controlled
F	Controlled	Controlled	Controlled	Controlled

### [Fan control state] (Request code : "53")

Data display

0 0 \* \*

Fan step correction value by heat sink temperature overheat prevention control

Fan step correction value by cool condensation temperature overheat prevention control

Display	Correction value
– (minus)	– 1
0	0
1	+1
2	+2

**[Actuator output state] (Request code : "54")**

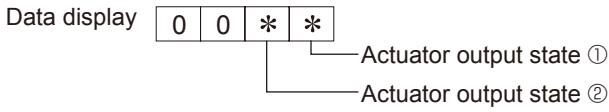

Actuator output state ①

Display	SV1	4-way valve	Compressor	Compressor is warming up
0				
1	ON			
2		ON		
3	ON	ON		
4			ON	
5	ON		ON	
6		ON	ON	
7	ON	ON	ON	
8				ON
9	ON			ON
A		ON		ON
b	ON	ON		ON
C			ON	ON
d	ON		ON	ON
E		ON	ON	ON
F	ON	ON	ON	ON

Actuator output state ②

Display	52C	SV2	SS
0			
1	ON		
2		ON	
3	ON	ON	
4			ON
5	ON		ON
6		ON	ON
7	ON	ON	ON

**[Error content (U9)] (Request code : "55")**

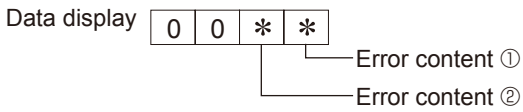

Error content ①

● : Detected

Display	Overvoltage error	Undervoltage error	L <sub>1</sub> -phase open error	Power synchronizing signal error
0				
1	●			
2		●		
3	●	●		
4			●	
5	●		●	
6		●	●	
7	●	●	●	
8				●
9	●			●
A		●		●
b	●	●		●
C			●	●
d	●		●	●
E		●	●	●
F	●	●	●	●

Error content ②

● : Detected

Display	Converter Fo error	PAM error
0		
1	●	
2		●
3	●	●

**[Outdoor unit – Capacity setting display] (Request code : "70")**

Data display	Capacity
40	160
50	200

**[Outdoor unit – Setting information] (Request code : "71")**

Data display 0 0 \* \*

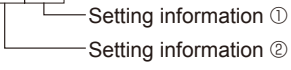

Setting information ①

Display	Defrost mode
0	Standard
1	For high humidity

Setting information ②

Display	Single-/ 3-phase	Heat pump/ cooling only
0	Single-phase	Heat pump
1		Cooling only
2	3-phase	Heat pump
3		Cooling only

PUHZ-SW160YKA.UK

PUHZ-SW200YKA.UK

PUHZ-SW160YKA-BS.UK

PUHZ-SW200YKA-BS.UK

PUHZ-SW160YKAR1.UK

PUHZ-SW200YKAR1.UK

PUHZ-SW160YKAR1-BS.UK

PUHZ-SW200YKAR1-BS.UK

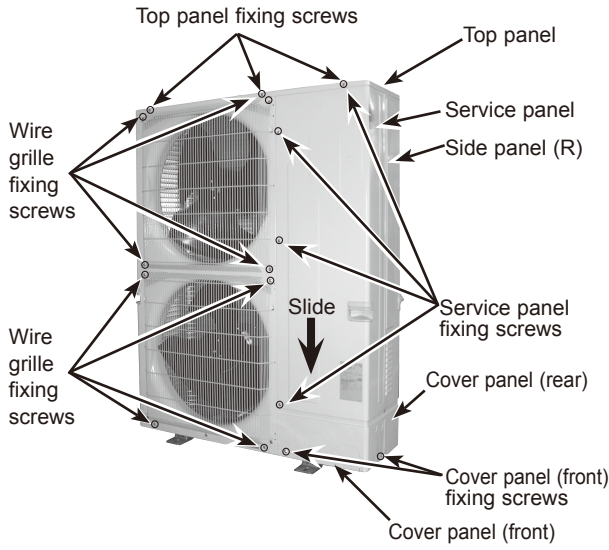
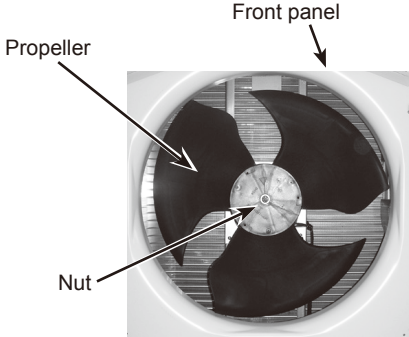
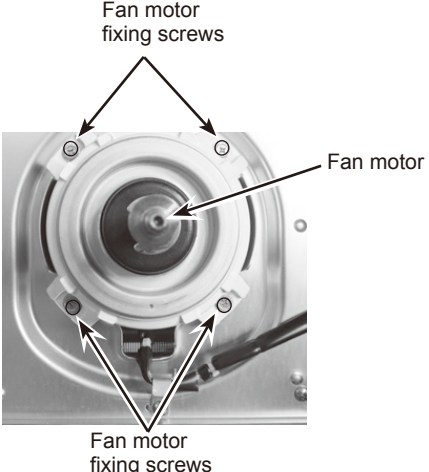
OPERATING PROCEDURE	PHOTOS
<p><b>1. Removing the service panel and top panel</b></p> <p>(1) Remove the service panel fixing screws (4 for front/ 5 x 12), then slide the service panel downward to remove it. (The service panel is fixed to the side panel (R) with a hook on the right side.)</p> <p>(2) Remove the top panel fixing screws (3 for front and 3 for rear/ 5 x 12) to remove the top panel.</p> <p>Note: When removing service panel and top panel at the same time, count one less screw since they share a screw.</p>	<p><b>Photo 1</b></p> 
<p><b>2. Removing the fan motor (MF1, MF2)</b></p> <p>(1) Remove the service panel. (See Photo 1)</p> <p>(2) Remove the wire grille fixing screws (4 for front/ 5 x 12), then slide the wire grille upward to remove it. (See Photo 1) (For the each fan motor on top and under)</p> <p>(3) Remove the screw of nut (1 for front/ M6), then slide the propeller fan forward to remove it. (For the each fan motor on top and under)</p> <p>(4) Disconnect the connectors, CNF1 (WHT) and CNF2 (WHT) on the controller circuit board in the electrical parts box. (See Photo 4)</p> <p>(5) Loosen the clamp for the lead wire on motor support and separator.</p> <p>(6) Release the lead wire from the hole on separator.</p> <p>(7) Remove the fan motor fixing screws (4 for front/ 5 x 20) to remove the fan motor. (For the each fan motor on top and under)</p>	<p><b>Photo 2</b></p>  <p><b>Photo 3</b></p> 



## OPERATING PROCEDURE

### 3. Removing the electrical parts box

- (1) Remove the service panel. (See Photo 1)
- (2) Remove the top panel. (See Photo 1)
- (3) Disconnect the power supply cable from terminal block.
- (4) Disconnect the indoor/outdoor connecting wire from terminal block.
- (5) Disconnect the connector CNF1 (WHT), CNF2 (WHT), TH3 (WHT), TH7/ 6 (RED), TH32 (BLK), 63H (YLW), 21S4 (GRN), LEV-A (WHT) and 63HS (WHT) from the controller circuit board.
  - <Symbols on the board>
  - Fan motor (CNF1, CNF2)
  - Thermistor <Liquid> (TH3)
  - Thermistor <Ambient/ 2-Phase Pipe> (TH7/6)
  - Thermistor <Comp. Surface> (TH32)
  - High pressure switch (63H)
  - 4-way valve (21S4)
  - LEV (LEV-A)
  - High pressure sensor (63HS)
- (6) Loosen the clamps, fasteners and cable strap for the lead wire in the electrical parts box and separator. (See photo 4)
- (7) Loosen the lead wires fixed to the pipes with bands.
- (8) To disconnect the COMP lead wire, remove the terminal cover, then remove the COMP lead wire fixing screws (4 for front/ 5 x 12).
- (9) Remove the electrical parts box fixing screws (2 for front/ 4 x 10), then slide the electrical parts box upward to remove it.

(The electrical parts box is fixed to the side panel (R) with a hook on the right side, and to the separator duct with a hook on the left side.)

## PHOTOS

Photo 4

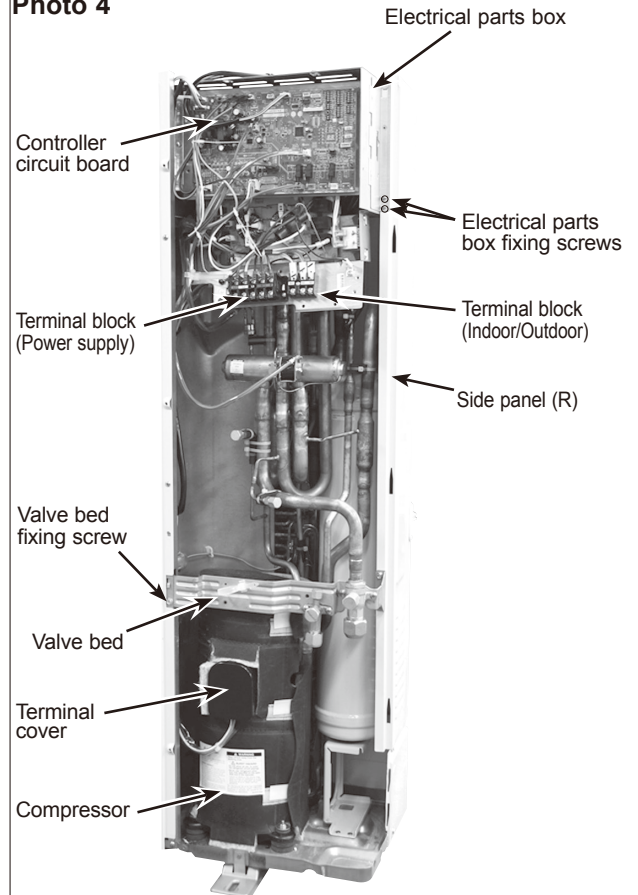

## OPERATING PROCEDURE

### 4. Disassembling the electrical parts box

- (1) Disconnect all the connectors on the controller circuit board.
- (2) To remove the controller circuit board, release it from the support.
- (3) Remove cont base fixing screws (2 for front/ 4 x 10). (Photo 5)  
(The cont. base is fixed to the cont base piece with a hook on the left side.)
- (4) Disconnect all the connectors on the noise filter circuit board. (Photo 6)
- (5) To remove the noise filter circuit board, release it from the support.
- (6) Remove N.F. base fixing screws (2 for front/ 4 x 10). (Photo 7)
- (7) Disconnect all the connectors on the power circuit board.
- (8) To remove the power circuit board, remove power board fixing screws (4 for front/ 4 x 12), then release the board from the support. (Photo 8)
- (9) The reactor is attached to the rear side of the electrical parts box. (Photo 9)  
(To remove the reactor, the electrical parts box must be separated from the outdoor unit.)

**Note: When reassembling the electrical parts box, make sure the wirings are correct.**

## PHOTOS

Photo 5

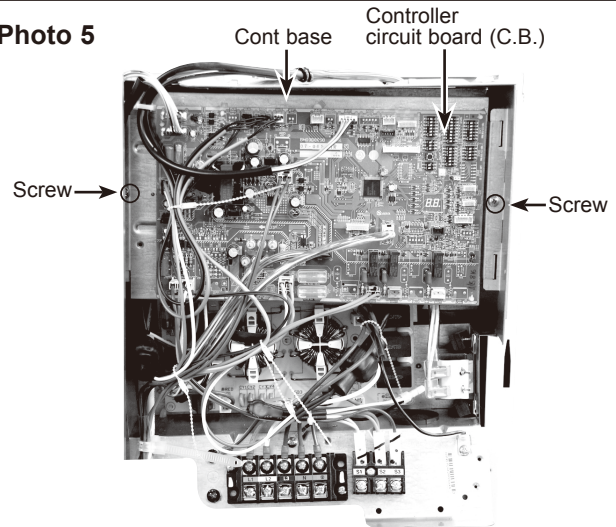

Photo 6

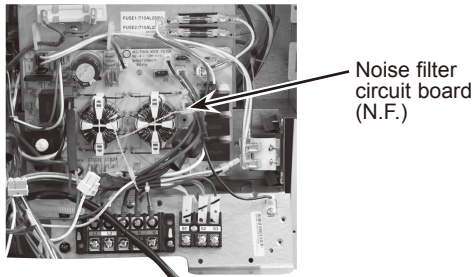

Photo 7

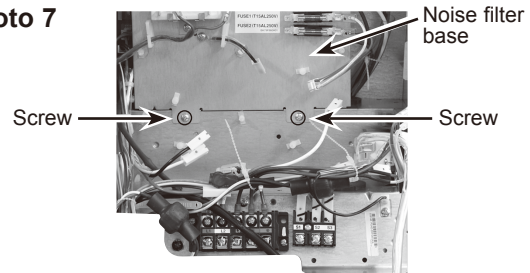

Photo 8

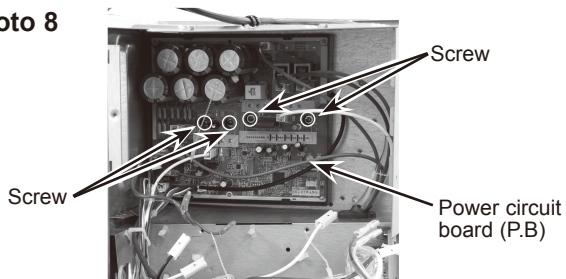
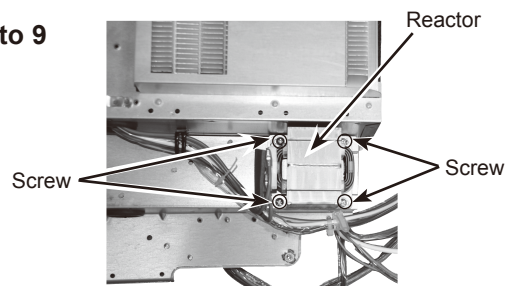

Photo 9



### 5. Removing the thermistor <2-Phase Pipe> (TH6)

- (1) Remove the service panel. (See Photo 1)
- (2) Remove the top panel. (See Photo 1)
- (3) Disconnect the connector TH7/6 (RED) on the controller circuit board in the electrical parts box. (See Photo 4)
- (4) Loosen the fastener for the lead wire in the electrical parts box.
- (5) Loosen the clamp for the lead wire on the top of electrical parts box.
- (6) Pull out the thermistor <2-phase pipe> (TH6) from thermistor clip.

**Note: When replacing thermistor <2-phase pipe> (TH6), replace it together with thermistor <Ambient> (TH7) since they are combined together. Refer to procedure No.5 on the next page to remove the thermistor <Ambient> (TH7).**

Photo 10

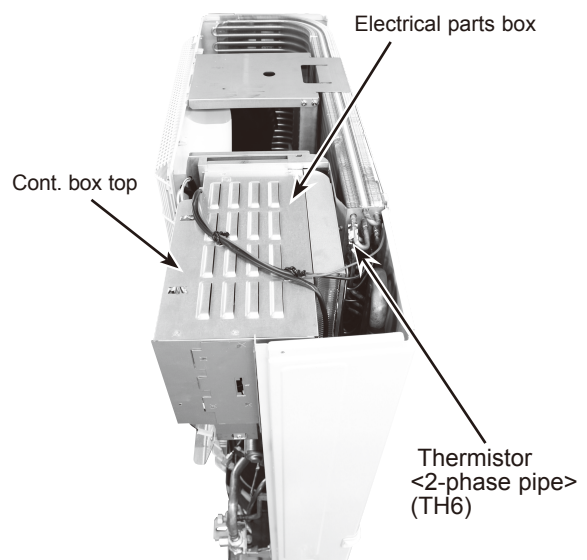

## OPERATING PROCEDURE

### 6. Removing the thermistor <Ambient> (TH7)

- (1) Remove the service panel. (See Photo 1)
- (2) Remove the top panel. (See Photo 1)
- (3) Disconnect the connector TH7/6 (RED) on the controller circuit board in the electrical parts box. (See Photo 4)
- (4) Loosen the fastener for the lead wire in the electrical parts box.
- (5) Loosen the clamps for the lead wire on top of the electrical parts box.
- (6) Pull out the thermistor <Ambient> (TH7) from thermistor holder.

**Note:** When replacing thermistor <Ambient> (TH7), replace it together with thermistor <2-phase pipe> (TH6), since they are combined together. Refer to procedure No.4 in the previous page to remove the thermistor <2-phase pipe>(TH6).

## PHOTOS

Photo 11

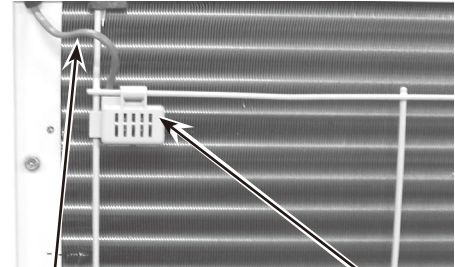

Lead wire of thermistor <Ambient> (TH7)      Sensor holder

### 7. Removing the thermistor <Liquid> (TH3), and thermistor <Comp. surface> (TH32).

- (1) Remove the service panel. (See Photo 1)
- (2) Disconnect the connector, TH3 (WHT) and TH32 (BLK) on the controller circuit board in the electrical parts box. (See Photo 4)
- (3) Loosen the fastener, cable strap and band for the lead wire on the controller circuit board in the electrical parts box.
- (4) Loosen the clamp for the lead wire on separator.
- (5) Pull out the thermistor <Liquid> (TH3) from thermistor clip.
- (6) Remove the top damper, then pull out the thermistor <Comp. surface> (TH32) from thermistor holder.
- (7) Disconnect the connector from the high pressure sensor, then remove the high pressure sensor.

Photo 12

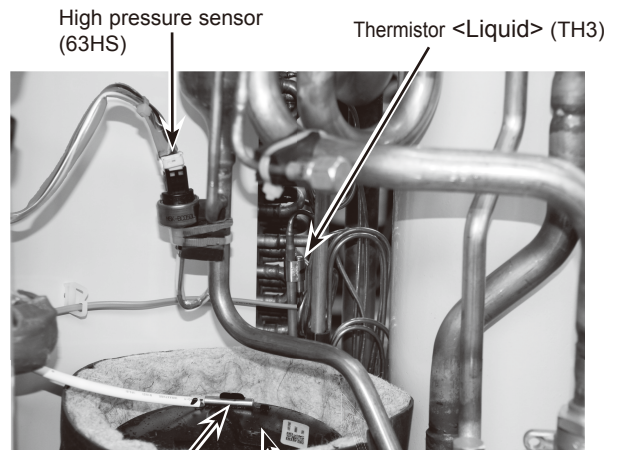

Thermistor <Comp. surface> (TH32)      Compressor      Damper

## OPERATING PROCEDURE

### 8. Removing the 4-way valve coil (21S4), LEV coil (LEV (A)) and lead wire for high pressure switch.

- (1) Remove the service panel. (See Photo 1)
- (2) Remove the top panel. (See Photo 1)
- (3) Remove the electrical parts box. (See Photo 4)
- (4) Loosen the clamp for the lead wire on separator.

#### [Removing the lead wire for high pressure switch]

- (5) Disconnect the lead wire from the high pressure switch.

#### [Removing the 4-way valve coil]

- (5) Remove the 4-way valve coil fixing screw (1 for front/ M5) to remove the 4-way valve coil.
- (6) Slide the 4-way valve coil forward to remove it.

#### [Removing the LEV coil]

- (5) Loosen the lead wires fixed to the pipes with bands.
- (6) Slide the LEV coil upward to remove it.

### 9. Removing the 4-way valve, LEV (LEV (A)) and high pressure switch.

- (1) Remove the service panel. (See Photo 1)
- (2) Remove the top panel. (See Photo 1)
- (3) Remove the electrical parts box. (See Photo 4)
- (4) Remove the cover panel (front). (See Photo 1)
- (5) Remove the cover panel (rear). (See Photo 1)
- (6) Remove the valve bed. (See Photo 14)
- (7) Remove the side panel (R).
- (8) Recover refrigerant.

#### [Removing the 4-way valve]

- (9) Remove the 4-way valve coil. (See photo 13)
- (10) Remove the welded part of 4-way valve (4 positions) to remove the 4-way valve.

#### [Removing the LEV]

- (9) Remove the LEV coil. (See photo 13)
- (10) Remove the welded part of LEV (2 positions) to remove the LEV.

#### [Removing the high pressure switch]

- (9) Disconnect the lead wire from the high pressure switch.
- (10) Remove the welded part of high pressure switch (1 position) to remove the high pressure switch.

**Note 1: Recover refrigerant without spreading it in the air.**

**Note 2: The welded part can be removed easily by removing the side panel (R).**

**Note 3: When installing the following parts, cover it with a wet cloth to prevent it from heating as the temperature below, then braze the pipes so that the inside of pipes are not oxidized;**

- 4-way valve, 120°C or more
- LEV, 120°C or more
- High pressure switch, 100°C or more

## PHOTOS

Photo 13

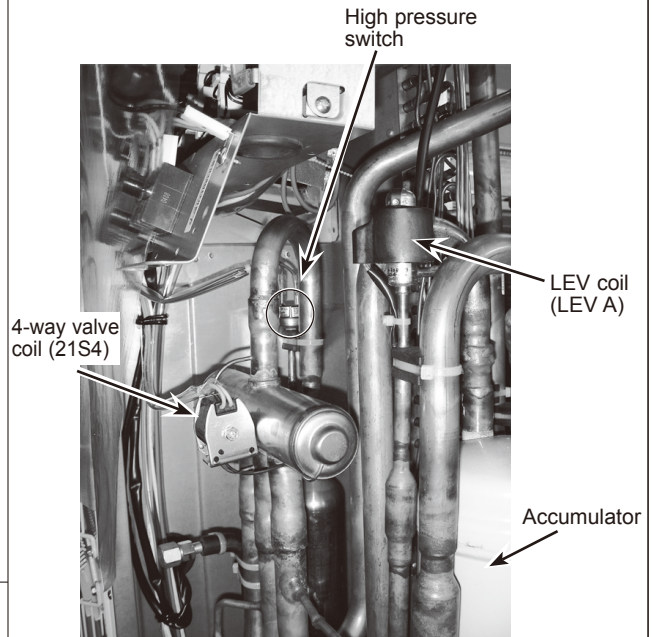



## OPERATING PROCEDURE

### 10. Removing the compressor (MC)

- (1) Remove the service panel. (See Photo 1)
- (2) Remove the top panel. (See Photo 1)
- (3) Remove the electrical parts box. (See Photo 4)
- (4) Remove the cover panel (front). (See Photo 1)
- (5) Remove the cover panel (rear). (See Photo 1)
- (6) Remove the valve bed. (See photo 14)
- (7) Remove the side panel (R). (See Photo 1)
- (8) Remove the front panel fixing screws (5 for front/ 5x12 and 2 for front/ 4x10), then slide the front panel upward to remove it.  
(The front panel is fixed with 4 hooks; 3 on the left side fixing to the side panel (L), and the other on the right side fixing to the separator.)
- (9) Release the lead wire for FM1 and FM2 from the hole on separator.
- (10) Remove the separator fixing screws (4 for front/ 4x10), then slide the separator upward to remove it.  
(The separator is fixed to a hook of the side plate.)
- (11) Recover refrigerant.
- (12) Remove the welded part of compressor (2 positions).
- (13) Remove the 3 compressor fixing nuts (M6) to remove the compressor.

**Note 1: Recover refrigerant without spreading it in the air.**

**Note 2: The compressor can be easily removed by removing separator.**

## PHOTOS

**Photo 14**

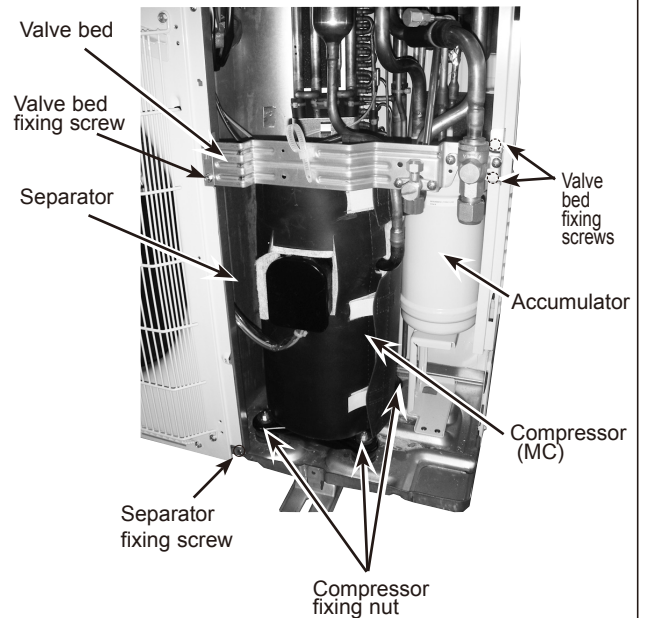

### 11. Removing the power receiver

- (1) Remove the service panel. (See Photo 1)
- (2) Remove the top panel. (See Photo 1)
- (3) Remove the electrical parts box. (See photo 4)
- (4) Remove the cover panel (front). (See Photo 1)
- (5) Remove the cover panel (rear). (See Photo 1)
- (6) Remove the valve bed. (See Photo 14)
- (7) Remove the side panel (R). (See Photo 1)
- (8) Recover refrigerant.
- (9) Remove the welded part of the accumulator (2 positions) to remove the accumulator.
- (10) Remove the receiver leg fixing screws (2 for front/ 4 x 10), then slide the power receiver forward to remove it.  
(The power receiver is fixed to the base with a hook on the bottom.)

**Note: Recover refrigerant without spreading it in the air.**

**Photo 15**

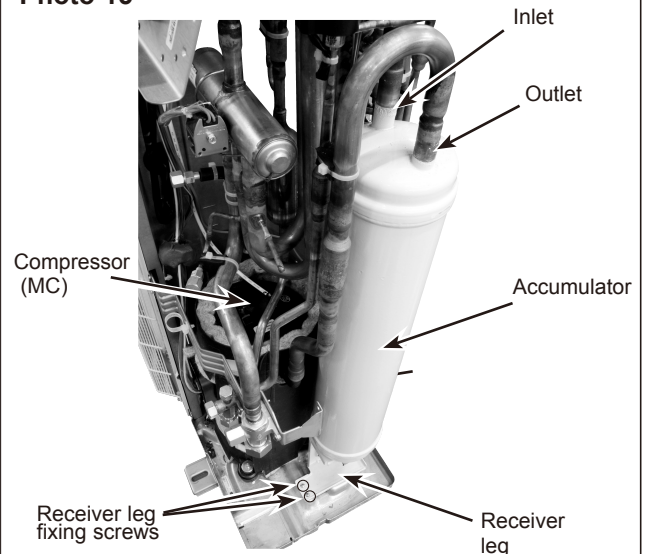

# **mitsubishi electric corporation**

HEAD OFFICE : TOKYO BLDG., 2-7-3, MARUNOUCHI, CHIYODA-KU, TOKYO 100-8310, JAPAN

---