



# ***Service Manual***

## **AIR SOURCE HEAT PUMP WATER HEATER**

(GC202401-I)

Capacity: 1.7kW

Rated Frequency: 50Hz/60Hz

Operation Range : -7°C~45°C

# Contents

<b>PRODUCT</b> .....	<b>5</b>
<b>1 MODELS LIST</b> .....	<b>5</b>
<b>2 NOMENCLATURE</b> .....	<b>5</b>
<b>3 INTRODUCTIONS TO COMPONENTS</b> .....	<b>6</b>
<b>4 PRODUCT PARAMETERS</b> .....	<b>6</b>
4.1 General .....	6
4.2 Electrical Specification .....	6
4.3 Connections Specifications .....	7
4.4 Specifications for the Heat Pump .....	7
4.5 Performances—Average Climate 7/6°C .....	7
4.6 Performances—Warmer Climate 14/13°C .....	8
4.7 Performances—Colder Climate 2/1°C .....	8
4.8 Product Performance Curves .....	9
<b>5 WORKING PRINCIPLE AND FEATURES OF PRODUCT</b> .....	<b>10</b>
<b>6 OPTIONAL ACCESSORIES</b> .....	<b>10</b>
<b>CONTROL</b> .....	<b>11</b>
<b>1 UNIT CONTROL</b> .....	<b>11</b>
1.1 Overall Product Control Ideas .....	11
1.2 Control and Protection .....	11
<b>2 WIRED CONTROLLER</b> .....	<b>12</b>
2.1 Operating Modes .....	13
2.2 Functions .....	13
<b>3 QUERY PARAMETERS</b> .....	<b>13</b>
<b>4 INSTRUCTION FOR OPERATION</b> .....	<b>14</b>
4.1 ON/OFF .....	14
4.2 Boost Mode Setting .....	14
4.3 Temperature Setting .....	14
4.4 Timer Setting .....	15
4.5 Setting of Functions .....	17
4.6 WiFi Function Setting .....	19
4.7 Other Functions .....	19
4.8 Reset to Ex-Factory Setting .....	21
4.9 Display of Energy Consumption .....	21
4.10 Error Display .....	23
<b>INSTALLATION</b> .....	<b>24</b>

<b>1 INSTALLATION FLOWCHART .....</b>	<b>24</b>
<b>2 PREPARATIONS .....</b>	<b>25</b>
2.1 Precautions for Engineering Installation .....	25
2.2 Before Installation .....	27
2.3 Design Drawing Review .....	27
2.4 Installation Material Selection .....	27
<b>3 INSTALLATION OF PRODUCT .....</b>	<b>29</b>
3.1 Safety Notices for Installation, Maintenance and Relocation of Unit.....	29
3.2 Unit Installation Diagram.....	29
3.3 Structural Dimension.....	30
3.4 Requirements of Installation Dimension.....	30
3.5 Installation Requirements .....	31
3.6 Installation Requirements of Water System Pipeline .....	31
3.7 Installation Requirements for Pipeline of Wind System .....	33
3.8 Electrical Installation .....	35
3.9 Wired Controller Installation .....	36
3.10 Detailed Installation Instructions for Unit Fixing Belt.....	38
<b>4 COMMISSIONING OPERATION .....</b>	<b>39</b>
4.1 Check before Commissioning .....	39
4.2 Trial Operation .....	39
4.3 Debugging for Air Volume .....	39
<b>5 CHECKS BEFORE ACCEPTANCE .....</b>	<b>40</b>
<b>6 COMMON PHENOMENA.....</b>	<b>41</b>
<b>REPAIR .....</b>	<b>42</b>
<b>1 ERROR CODE .....</b>	<b>42</b>
<b>2 TROUBLESHOOTING .....</b>	<b>43</b>
2.1 E6-Communication Error .....	43
2.2 E1-High Pressure Protection .....	43
2.3 E3-Refrigerant-lacking Protection .....	44
2.4 E4-High Discharge Temperature Protection.....	44
2.5 F3, F4, F6, Fd, FE, FL-Temperature Sensor Error .....	45
2.6 U7-Abnormal Reversing of 4-Way Valve .....	45
2.7 H5-Inverter Compressor Driver IPM Module Protection .....	46
2.8 H7-Inverter Compressor Out-of-Step Protection .....	47
2.9 HC-Inverter Compressor Driver PFC Protection .....	48
2.10 Lc-Inverter Compressor Startup Failure .....	48
2.11 Ld-Inverter Compressor Default Phase Protection .....	49
2.12 P0-Inverter Compressor Driver Module Reset .....	50
2.13 P5-Inverter Compressor Overcurrent Protection .....	51

2.14 P6-Master Controller and Inverter Compressor Driver Communication Error .....	51
2.15 P7-Inverter Compressor Driver Module Temperature Sensor Error .....	52
2.16 P8-Inverter Compressor Driver Module High-Temperature Protection.....	53
2.17 PA-Inverter Compressor Driver AC Protection (Input Side) .....	54
2.18 Pc-Inverter Compressor Driver Current Detecting Circuit Error .....	54
2.19 PL-Inverter Compressor Driver DC Bus Low Voltage Protection or Voltage Drop Error .....	55
2.20 PH-High Voltage Protection for Drive DC Bus of Inverter Compressor .....	55
2.21 PU-Inverter Compressor Driver Charging Loop Error.....	55
2.22 ee-Inverter Compressor Driver Storage Chip Error .....	56
2.23 AC-Inverter Fan Startup Failure .....	57
2.24 Ad-Inverter Fan Less Phase Protection.....	57
2.25 AE- Inverter Fan Driver Current Detecting Circuit Error.....	58
2.26 AL-Inverter Fan Driver DC Bus Low-Voltage Protection or Voltage Drop Error .....	58
2.27 AJ-Inverter fan Out-of-Step Protection .....	59
2.28 AH-Inverter Fan Driver DC Bus High-Voltage Protection.....	59
2.29 A1-Drive IPM Module Protection for Inverter Fan .....	60
2.30 A6-Master Controller and Inverter Fan Driver Communication Error .....	61
2.31 UL-Inverter Fan Overcurrent Protection .....	62
<b>3 REPAIR OF KEY COMPONENTS.....</b>	<b>63</b>
3.1 Introduction of Parts.....	63
3.2 Introduction of Key Components.....	63
3.3 Disassembly of Key Components .....	63
3.4 Thermostat Reset Operation.....	68
3.5 Detailed Maintenance Instructions for Refrigeration System .....	69
<b>4 EXPLODED VIEW AND PARTS LIST .....</b>	<b>75</b>
<b>MAINTENANCE .....</b>	<b>76</b>
<b>1 WATER RECHARGE, DRAINAGE AND CLEANING .....</b>	<b>76</b>
1.1 Water Recharge.....	76
1.2 Water Drainage.....	76
1.3 Cleaning of Water Tank of the Unit.....	76
<b>2 MAINTENANCE OF ANODE ROD.....</b>	<b>76</b>
<b>3 MAINTENANCE OF SAFETY VALVE .....</b>	<b>77</b>
<b>4 MAINTENANCE IN WINTER.....</b>	<b>77</b>
<b>ATTACHMENT .....</b>	<b>78</b>
<b>TABLE OF THE TEMPERATURE SENSOR RESISTANCE AND TEMPERATURE.....</b>	<b>78</b>

## PRODUCT

### 1 MODELS LIST

Product type	Model	Product Code	Heating capacity	Outline diagram
Integral type	GRS-1.5Pd/TD200ANpA-K	ER02100150	1700W+2000W (electrical heater)	
	GRS-1.5Pd/TD270ANpA-K	ER02100160	1700W+2000W (electrical heater)	

### 2 NOMENCLATURE

GRS	-	1.5	□	Pd	□	/	T	D	200	A	□	□	Np	A	□	□	-	K
1		2	3	4	5		6	7	8	9	10	11	12	13	14	15		16

No.	Description	Options
1	Product code	GRS—Heat pump water heater
2	Heating capacity code	Heating capacity (Unit: kW)
3	Compressor system	Single system – Omit; Dual system – S
4	Functions characteristics 1	Fixed frequency – Omit; Inverter – P; DC Inverter – Pd; Fixed frequency modular – M; AC Inverter modular – PM; DC Inverter modular – PdM
5	Functions characteristics 2	Normal type – Omit; Low temperature heat pump – Re
6	Water tank material	Stainless Steel – Omit; T –Enameled steel
7	Function code	No electric heating function – Omit; With electric heating function – D
8	Water tank capacity	Capacity of water tank; Unit: (L)
9	Design code	A—LCJW: floor standing type; outer coil pipe static heating type; B—BCJW: wall-mounted type; outer coil pipe static heating type; C—LCJ: floor standing type; built-in coil pipe static heating type; D—BCJ: wall-mounted type; built-in coil pipe static heating type;
10	Water tank shape	Round – Omit; Square – F
11	Inner tank number	Single – Omit; Double – 2
12	Refrigerant	R22 – Omit; R407c – N; R410A – Na; R134a – Nb; R32 – Nh; R290- Np
13	Design Serial number	A, B, C...or A1, A2..., B1, B2...
14	Backwater function	No – Omit; Yes – H
15	E-commerce code	Non-e-commerce models – Omit; E-commerce models – D
16	Power code	M—380-415V 3PH~50Hz; K—220V-240V 1PH~50Hz; D—220V-240V 1PH~60Hz ...

### 3 INTRODUCTIONS TO COMPONENTS

No.	Name	Function
1	Compressor	Increases pressure for the refrigerant and provides driving force for circular flow of the refrigerant as a main driving component.
2	Four-way valve	Reverses flow direction of the refrigerant when the system switches between the normal heat up mode and defrosting mode.
3	Water tank	Provides heat exchange channel for refrigerant and water and stores hot water for daily use.
4	Electronic expansion valve	Speeds up high-pressure and high-temperature refrigerant and reduces pressure and adjusts the circulation amount of coolant.
5	Finned tube exchanger	Provides heat exchange channel for refrigerant and air.
6	Fan motor	Enhances heat exchange on the air side of the finned tube exchange and provides a low-temperature heat source continuously.
7	Filter	Filters impurities in refrigerant to protect components with small diameter.

### 4 PRODUCT PARAMETERS

#### 4.1 General

Model		GRS-1.5Pd/TD200ANpA-K	GRS-1.5Pd/TD270ANpA-K
Rated volume of the tank	L	206	270
Dimensions	W×D×H mm	668×663×1667	668×663×1947
Net Weight (when empty)	kg	96	108
Weight (full)	kg	302	378
Heat insulation	mm	50, Polyurethane foam	
Material of the product container	—	Enameled steel	
Water tank rated pressure	MPa	0.8	
Protection anti-corrosion	—	Electronic anode	
Compressor	—	DC Inverter, frequency varies with hot water demand	
Fan	—	DC Inverter, 0~60Pa <sup>(1)</sup> speed varies with ducts' length and hot water demand	
Defrosting	—	4-way-valve	
Throwing	—	Electronic expansion valve	

#### 4.2 Electrical Specification

Model		GRS-1.5Pd/TD200ANpA-K	GRS-1.5Pd/TD270ANpA-K
Power supply	—	220-240V ~ 50/60Hz	
Rated input of heat pump	W	850	
Rated input of electrical heater	W	2000	
Max power input	W	2850	
Max operating current	A	12.4	
IP rating	—	IPX4	

### 4.3 Connections Specifications

Model		GRS-1.5Pd/TD200ANpA-K	GRS-1.5Pd/TD270ANpA-K
Connections for the domestic hot water circuit	—	3/4" inside thread	
Air connections (inlet and outlet)	mm	160	

### 4.4 Specifications for the Heat Pump

Model		GRS-1.5Pd/TD200ANpA-K	GRS-1.5Pd/TD270ANpA-K
Heating capacity <sup>(2)</sup>	W	1700	1700
Power input <sup>(2)</sup>	W	425	425
COP <sup>(2)</sup>	—	4.0	4.0
Refrigerant	Name		R290
	Charge	kg	0.15
GWP	—	3	
CO <sub>2</sub> equivalent	t	0.00045	
Heat pump operating range	°C	-7~45	
Maximum and minimum water operating temperatures	°C	35~70	
Maximum and minimum water operating pressures	MPa	0.1~0.7	

### 4.5 Performances—Average Climate 7/6°C

EN 16147:2017+A1:2022, Outdoor air heat pump (placed indoor side),230V ~ 50Hz, 360m <sup>3</sup> /h, 30Pa <sup>(1)</sup>				
Model		GRS-1.5Pd/TD200ANpA-K	GRS-1.5Pd/TD270ANpA-K	
Thermostat set point temperature	°C	54	52	
Tapping load profile	—	XL	XL	
Class	—	A+	A+	
Coefficient of performance	COP <sub>DHW</sub>	3.20	3.50	
Water heating energy efficiency	$\eta_{wh}$	135%	145%	
Maximum volume of mixed water at 40°C	V <sub>40</sub>	L	328	
Reference hot water temperature	$\theta'_{WH}$	°C	54.7	52.3
Heating up time	t <sub>h</sub>	h:min	07:22	08:00
Heating up electrical energy consumption	W <sub>eh-HP</sub>	kWh	3.000	3.600
Stand-by power input	P <sub>es</sub>	W	37.50	30.50
Daily electrical energy consumption	Q <sub>elec</sub>	kWh	5.900	5.400
Annual electrical energy consumption	AEC	kWh/a	1250	1150
Sound power level LWA	outdoors/ indoors	dB(A)	54/48	

## 4.6 Performances—Warmer Climate 14/13°C

EN 16147:2017+A1:2022, Outdoor air heat pump (placed indoor side),230V ~ 50Hz, 360m <sup>3</sup> /h, 30Pa <sup>(1)</sup>				
Model			GRS-1.5Pd/TD200ANpA-K	GRS-1.5Pd/TD270ANpA-K
Thermostat set point temperature		°C	58	52
Tapping load profile		—	XL	XL
Coefficient of Performance	COP <sub>DHW</sub>	—	3.50	3.90
Water heating energy efficiency	$\eta_{wh}$	—	147%	160%
Maximum volume of mixed water at 40°C	V <sub>40</sub>	L	305	328
Reference hot water temperature	$\theta'_{WH}$	°C	58.2	52.3
Heating up time	t <sub>h</sub>	h:min	06:40	07:30
Heating up electrical energy consumption	W <sub>eh-HP</sub>	kWh	3.000	3.100
Stand-by power input	P <sub>es</sub>	W	39.00	28.00
Daily electrical energy consumption	Q <sub>elec</sub>	kWh	5.400	4.900
Annual electrical energy consumption	AEC	kWh/a	1140	1042

## 4.7 Performances—Colder Climate 2/1°C

EN 16147:2017+A1:2022, Outdoor air heat pump (placed indoor side),230V ~ 50Hz, 360m <sup>3</sup> /h, 30Pa <sup>(1)</sup>				
Model			GRS-1.5Pd/TD200ANpA-K	GRS-1.5Pd/TD270ANpA-K
Thermostat set point temperature		°C	56	52
Tapping load profile		—	XL	XL
Coefficient of Performance	COP <sub>DHW</sub>	—	2.90	2.90
Water heating energy efficiency	$\eta_{wh}$	—	120%	120%
Maximum volume of mixed water at 40°C	V <sub>40</sub>	L	280	328
Reference hot water temperature	$\theta'_{WH}$	°C	56.2	52.3
Heating up time	t <sub>h</sub>	h:min	08:10	09:50
Heating up electrical energy consumption	W <sub>eh-HP</sub>	kWh	3.700	4.000
Stand-by power input	P <sub>es</sub>	W	39.00	32.00
Daily electrical energy consumption	Q <sub>elec</sub>	kWh	6.400	6.500
Annual electrical energy consumption	AEC	kWh/a	1360	1388

### NOTES:

- ① The performance parameters in accordance with EN 16147:2017+A1:2022, (EU) No 814/2013.
- ② Noise (the sound power level) is measured according to EN 12102-2:2019.
- ③ The technical parameters test in a new unit with clean heat exchangers and in auto water heating mode.
- ④ <sup>(1)</sup> Indicates that the adjustment parameters of E26 on the wired controller are different under different air outlet static pressures. See Section (INSTALLATION) 4.3 for details.
- ⑤ <sup>(2)</sup> Indicates that the parameters obtained with the following conditions: Outdoor temperature: 14°C DB/13°CWB; Water tank temperature (start/end): 10°C/55°C; With no ducts.
- ⑥ Please always see the nameplate for the exact data as this table is subject to change.



## 4.8 Product Performance Curves

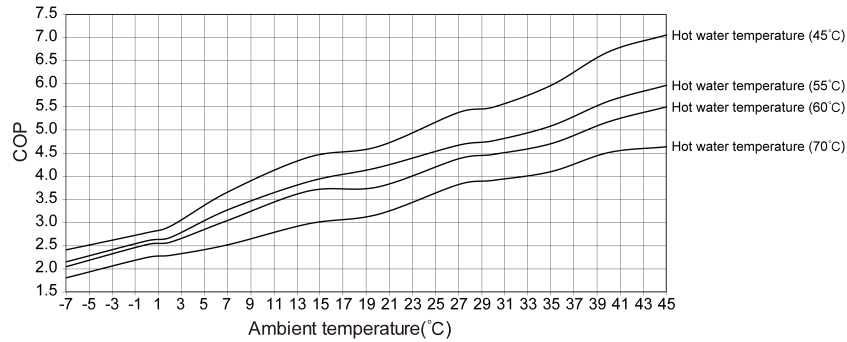

Fig.4.8-1 COP at different ambient temperatures when heating to different hot water target temperatures

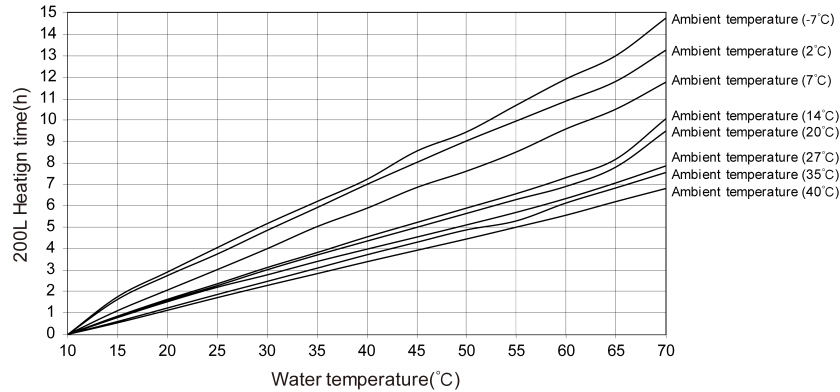

Fig. 4.8-2 GRS-1.5Pd/TD200ANpA-K heating time to different hot water target temperatures for different ambient temperatures

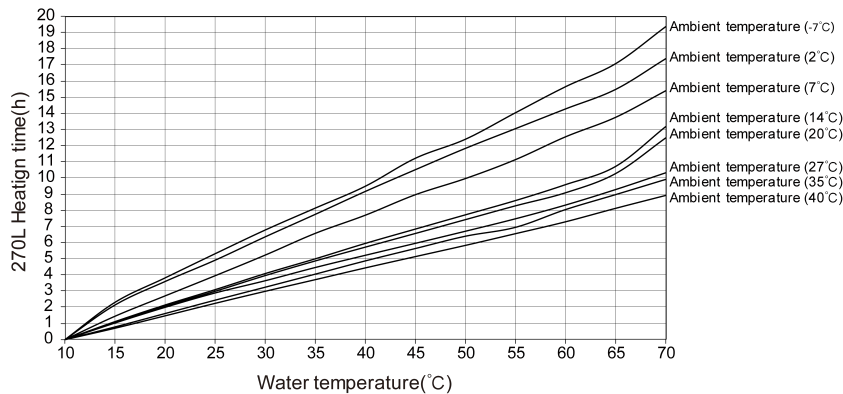

Fig. 4.8-3 GRS-1.5Pd/TD270ANpA-K heating time to different hot water target temperatures for different ambient temperatures

### NOTES:

- ① The above curve data are fitted based on the test parameters of Gree Laboratory (The test conditions are: initial water temperature: 10°C, power supply: 230V ~ 50Hz; static pressure of air outlet: 30Pa; air volume: 360 m<sup>3</sup>/h; in a new unit with clean heat exchangers and in auto water heating mode). So there will be about 5% tolerance and the curves are for reference only.
- ② In BOOST mode, the electrical heater and heat pump will be together started to heating. The heating rate of GRS-1.5Pd/TD200ANpA-K and GRS-1.5Pd/TD270ANpA-K is increased by about 7.9°C/h and 6°C/h respectively. On the other hand, COP will decrease and power consumption will increase.

## 5 WORKING PRINCIPLE AND FEATURES OF PRODUCT

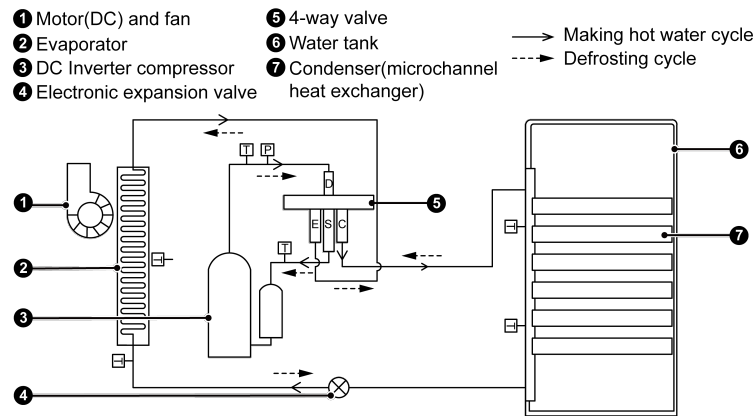

Fig.5-1 Air source water heater operating principle

The heat pump principle is used by the air source heat pump water heater. When the unit normally makes hot water, the 4-way valve is powered off(D and C are connected, S and E are connected), the high-temperature and high-pressure refrigerant comes out of the compressor, enters the water tank heat exchanger(microchannel heat exchanger), condenses into high-pressure liquid, and then throttles into low-pressure gas-liquid two-phase refrigerant by the electronic expansion valve, and then enters the evaporator to absorb heat, become gaseous refrigerant, and then is inhaled by the compressor. Compressed into high temperature and high pressure gaseous refrigerant, and so repeated cycle.

When the unit defrosts, the 4-way valve is powered on (D and E are connected, S and C are connected). The evaporator of the unit is used as a condenser, and the microchannel heat exchanger is used as a evaporator), the high-temperature and high-pressure gaseous refrigerant comes out of the compressor, enters the evaporator after the 4-way valve, condenses into a high-pressure liquid, and then passes through the electronic expansion valve to throttle into a low-pressure gas-liquid two-phase refrigerant, and then enters the water tank heat exchanger. Becomes gaseous refrigerant, and then is inhaled by the compressor, compressed into high temperature and high pressure gaseous refrigerant, so repeated cycle.

Air source water heater is a new kind of high-efficiency, energy-saving and eco-friendly product. This series of units adopt a special compressor for heat pump water heater that is resistant to high temperature and pressure; the crystal titanium blue enamel inner tank produced with advanced technology is used on the water tank side. The entire unit is equipped with multiple protections to ensure the durability of the system. The unit has various heating modes and humanized functions for selection, e.g. timer on/off.

## 6 OPTIONAL ACCESSORIES

The unit supports the following accessories:

Item	Model	Remark
Self-limiting temperature tracing belt	76612816	
Pressure stabilizing valve	07382812	

### NOTE:

If any of the preceding accessories is required, contact with the local sales company.

# CONTROL

## 1 UNIT CONTROL

### 1.1 Overall Product Control Ideas

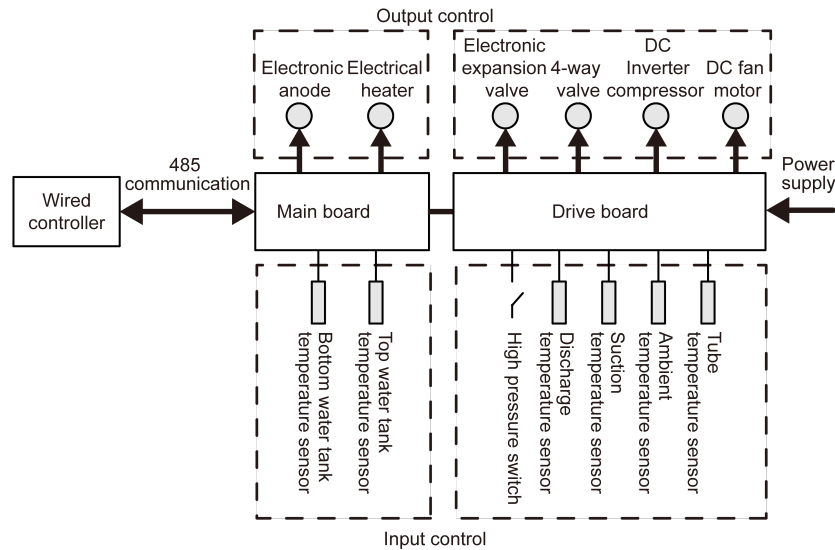

### 1.2 Control and Protection

#### (1) Temperature sensors

- 1) Top water tank temperature sensor, of which the resistance is 50K, used to detect the upper temperature of the water tank.
- 2) Bottom water tank temperature sensor, of which the resistance is 50K, used to detect the temperature at the lower part of the water tank.
- 3) Ambient temperature sensor, of which the resistance is 15K, used to detect the ambient temperature (inlet air temperature).
- 4) Suction temperature sensor, of which the resistance is 20K, used to detect the temperature of the suction temperature of the compressor.
- 5) Discharge temperature sensor, of which the resistance is 50K, used to detect the exhaust temperature of compressor.
- 6) Tube temperature sensor, of which the resistance is 20K, used to detect heat exchanger tube temperature.

#### (2) High pressure switch

Real-time detection the exhaust pressure of system, when the pressure reaches the protection value (3.2MPa, gauge pressure), the unit stops or does not start. When the discharge pressure is less than 2.6MPa (gauge pressure), the system automatically resumes operation. If the discharge pressure protection accumulates for three times within 120 minutes, the system cannot resume operation, and the high pressure protection fault code is displayed on the wire controller. Press the on/off button to clear the fault.

#### (3) High discharge temperature protection

When the gas discharge temperature is greater than or equal to 115°C, the unit stops or does not start. When the discharge temperature is less than 90°C, the system automatically resumes operation. If the above phenomenon is detected for three times within 60 minutes, the system cannot resume

operation, and the high discharge protection fault code is displayed on the wire controller. If the exhaust high-temperature protection accumulates for three times within 60 minutes, press the on/off button to clear the fault.

#### (4) Anti-freezing function

When the unit is shut down, the system detects that the water temperature of the unit. If the water temperature is too low in the low ambient temperature; the unit will directly start for antifreeze operation.

#### (5) Control on DC Inverter compressor

After power is connected, start the system by the wired controller and detect the outdoor ambient temperature sensor. If the outdoor ambient temperature is not lower than  $-7^{\circ}\text{C}$  and when no error is detected and start up conditions of the compressor are met, the system starts by following the hot water sequence. The frequency of the compressor will determine by the hot water demand.

#### (6) Control on DC fan motor

When start up conditions of the compressor is met, the system starts by following the hot water sequence. The electronic expansion valve resets and is initialized, and the fan motor starts. Then speed of the fan will determine by the length of the ducts and hot water demand.

#### (7) Control on defrosting

In low temperature environment, if the defrosting condition is met, the system defrosts. After defrosting is over, the compressor and the fan start for heat up. When the cumulative operation time exceeds or equals to the preset time for defrosting, defrosting will be performed if the temperature difference between the outdoor exchanger pipe and environment temperature sensor meets the defrosting condition.

## 2 WIRED CONTROLLER

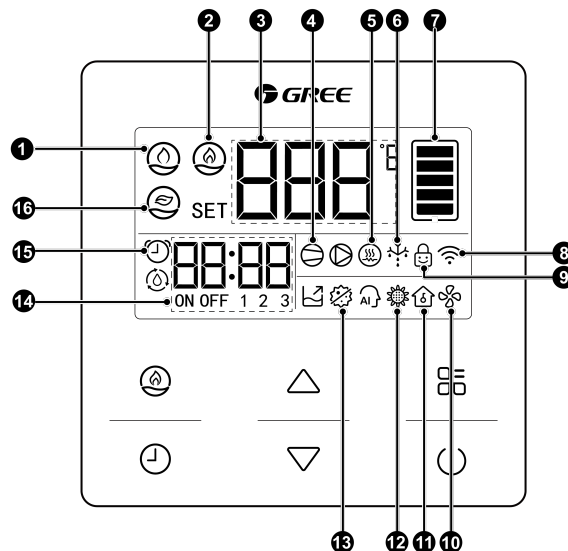

Fig.2-1 LCD Display of Wired Controller  
Table 2-1 LCD Display Description

No.	Symbols	Instructions
1		Auto water heating
2		BOOST function icon
3		Temperature area
4		Operating status of compressor

No.	Symbols	Instructions
5		Operating status of auxiliary electric heating
6		Defrosting status
7		Hot water amount
8		WiFi status
9		Child lock
10		Ventilation
11		Holiday
12		Sunflower
13		Sterilization
14		Timer area
15		Timer ON/OFF icon
16		Timer ECO icon(Some units do not support this function)

NOTE: When wired controller is connected with different indoor units, some functions will be different.

## 2.1 Operating Modes

Table 2.1-1 Operation Modes Description

Name	Description
BOOST mode	Applicable for the unit with auxiliary electric heating function or some inverter units, which can shorten the heating operation time and heat up the water quickly.

## 2.2 Functions

Table 2.2-1 Functions Description

Name	Introduction
Timer on/off	To set timer on and timer off time, the unit will operate in the set period. After setting, the unit will operate circularly every day.
Sterilization	The unit can heat the water temperature to 70°C/158°F for the highest installed temperature to kill the Legion bacteria at high temperature. (Some units do not support this function)
Sunflower	The higher the ambient temperature is, the easier can the water heater absorb heat from ambient temperature, and the more energy-saving for heating will be. After sunflower function is activated, the water heater will heat up water in the period with relative higher ambient temperature of the day. In other period, it will heat up to medium water temperature at most. Compared to heating in relatively low ambient temperature, it is more energy-saving. It is recommended to activate this function for using only one tank of hot water in one day. After setting, it will conduct everyday circularly.
Holiday	After setting the days of holiday, it will preheat the water before you come back home. During the holiday, the water heater is in standby status. After the holiday ends, it will automatically end the function.
Ventilation	After the compressor stops, the fan keeps running to ensure normal ventilation inside the unit.
WiFi	Can control wired controller via smart App.

Note: Medium water temperature is generally 40°C, which is subject to the unit.

## 3 QUERY PARAMETERS

This function is provided for the debugging personnel to query running status of the unit. After pressing and holding “”+ “” button for 5 second, the parameter display area blinks. 00 is displayed by default. The “” and “” buttons can be pressed to switch the query item.

Query codes are described in the following table.

Query Code	Query Parameter
00	Protocol version number
01	The latest 1 faults
02	Temperature of the bottom water tank temperature sensor
03	Temperature of the top water tank temperature sensor
04	Temperature of the ambient temperature sensor
05	Temperature of the discharge temperature sensor
06	Temperature of the suction temperature sensor
07	Temperature of the tube temperature sensor
10	Display "00", and again holding "🔥" + "▲" button for 5 second ,the wired controller display the current electronic expansion valve step value
13	Display "00", and again holding "🔥" + "▲" button for 5 second, the wired controller display the current fan speed value.
14	Display "00", and again holding "🔥" + "▲" button for 5 second, the wired controller display the current frequency value of the compressor.

## 4 INSTRUCTION FOR OPERATION

### 4.1 ON/OFF

Press "🔌" button to start up auto water heating function. Press the button again can turn off the unit and stop the water heating function. ON state and OFF state interface of the unit are shown as below.

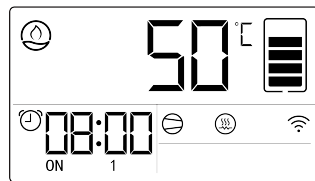

Fig.4.1-1 ON State Interface



Fig.4.1-2 OFF State Interface

### 4.2 Boost Mode Setting

In the ON state interface, each time press the "🔥" button for once, the BOOST mode can be turned on or turned off.

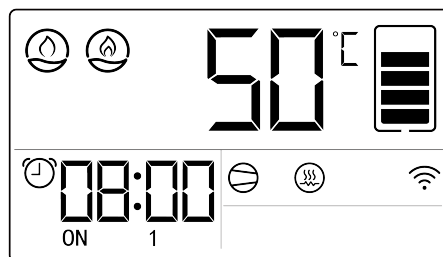

Fig.4.2-1 Turn on BOOST mode







### 4.3 Temperature Setting

In the ON state, press "▲" or "▼" button, the set temperature will increase or decrease for 1 degree Celsius or Fahrenheit; when press and hold the buttons, the set temperature will increase or decrease automatically for 1 degree Celsius or Fahrenheit in every 0.3 second.

The settable highest temperature of different modes is different. For the settable water temperature range of each unit shall refer to actual unit.

## 4.4 Timer Setting

### 4.4.1 Setting of System Time

- (1) Press “” button, the hour of clock icon flashes, press “” or “” button can adjust the hour.
- (2) Press “” button again, the minute of clock icon flashes, press “” or “” button can adjust the minute.
- (3) After connecting “Gree+” App, the system time will be subject to the time of “Gree+” App, and the system time cannot be set.
- (4) After setting the “Timer ON/OFF”, the system time and timer on time, timer off time are displayed by polling.
- (5) During setting, press “” button or no button operation for 20 seconds, it will automatically return to the homepage and the setting system time is done.

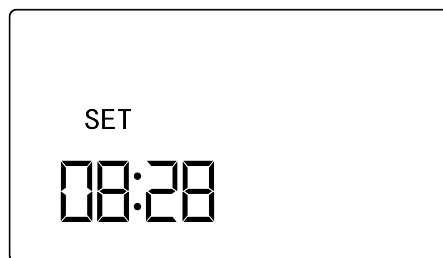

Fig.4.4-1 Setting of system time



(a) System time























(b) Timer on time



(c) Timer off time

Fig.4.4-2 Time display

### 4.4.2 Timer

- (1) Press “” button to enter setting interface of system time, after the system time is set, press “” button to enter timer ON/OFF setting interface, the temperature area “ON” or “OFF” are flashing, press “” or “” button can set timer ON/OFF, when it displays “ON”, it refers timer ON is activated; when it displays “OFF”, it refers the timer setting is off.
- (2) Press “” button again, set the timer ON hour, “” and “ON” icons are constantly on, and timer ON hour icon flashes, press “” or “” button to adjust timer ON hour.
- (3) Press “” button again, set the timer ON minute, “” and “ON” icons are constantly on, and timer ON minute icon flashes, press “” or “” button to adjust timer ON minute.
- (4) Press “” button again, set the timer OFF hour, “” and “OFF” icons are constantly on, and press “” or “” button to adjust timer OFF hour.
- (5) Press “” button again, set the timer OFF minute, “” and “OFF” icons are constantly on, and press “” or “” button to adjust timer OFF minute;
- (6) During setting, press “” button or no button operation for 20 seconds, it will automatically return to the homepage and the setting of timer ON/OFF time is done.

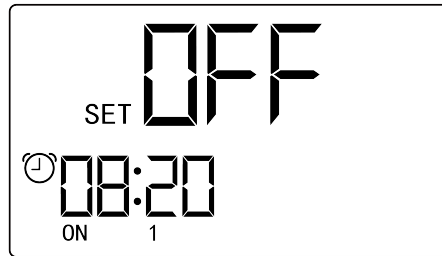

Fig.4.4-3 Setting of timer ON/OFF time

### 4.4.3 Multistep Timer Setting

- (1) In ON or OFF status, or setting interface of system time, press and hold “⏸” button for 5 seconds to enter setting of multistep timer ON/OFF function.
- (2) Press “□□” button again, the icons status will switch in timer ON/OFF 1, timer ON/OFF 2.
- (3) In timer ON/OFF 1 interface, “⏸” and “ON” and “1” icons are constantly on, press “⏸” button can set the ON/OFF time of timer ON/OFF 1, for setting methods please see “Timer ON/OFF setting”.
- (4) In timer ON/OFF 2 interface, “⏸” and “ON” and “2” icons are constantly on, press “⏸” button can set the ON/OFF time of timer ON/OFF 2, for setting methods please see “Timer ON/OFF setting”.
- (5) During setting, press “⏸” button or no button operation for 20 seconds, it will automatically return to the homepage and the setting of timer is done.

### 4.4.4 Weekly Timer Setting

Switch timer ON/OFF 2 as weekly timer, for setting method please see the setting of Timer 2 type in “Special parameters setting”.

- (1) Press and hold “⏸” button, switch to setting interface of timer ON/OFF 2 according to “Multistep timer setting”, then it is weekly timer setting.
- (2) “ON” or “OFF” in temperature area are flashing, press “△” or “▽” buttons to set on and off of weekly timer, when it displays “ON”, the weekly timer is activated, when it displays “OFF”, the weekly timer is turned off.
- (3) Press “⏸” button again, “⏸” and “2” icons are constantly on, “d:XX” is flashing, it refers to what day of the week currently. Press “△” or “▽” button can adjust the time. After connecting “Gree+” App, the system time will be subject to the time of “Gree+” App, and the system time cannot be set.
- (4) Press “⏸” button again, “⏸” and “2” and “ON” icons are constantly on, “d:XX” is flashing, it refers to it will turn on in what day of the week, Press “△” or “▽” button can adjust the weekly timer ON time.
- (5) Press “⏸” button again, “⏸” and “2” and “OFF” icons are constantly on, “d:XX” is flashing, press “△” or “▽” button can adjust the weekly timer OFF time.
- (6) During setting, press “⏸” button or no button operation for 20 seconds, it will automatically return to the homepage and the setting of timer is done.



(7) The following shows the current time, ON time, OFF time of weekly timer setting.

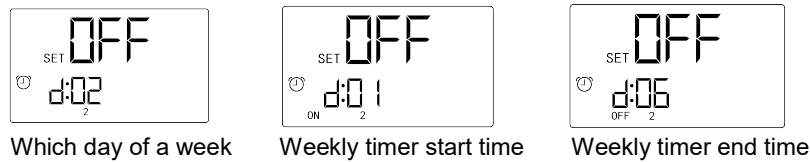

Which day of a week Weekly timer start time Weekly timer end time

Fig.4.4-4 Display of weekly timer

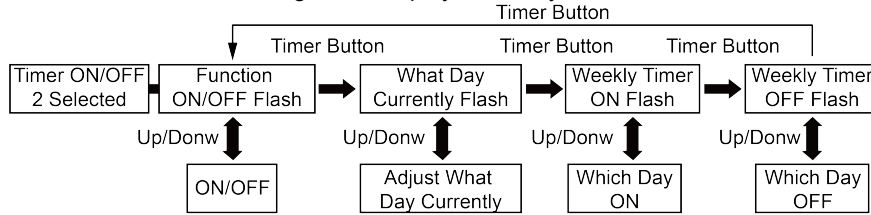

Fig.4.4-5 Setting steps of weekly timer

## 4.5 Setting of Functions

- (1) In power-on interface, press “ ” button to enter the function selection interface, and then press “ ” button to switch among sterilization, sunflower, holiday, ventilation; when setting corresponding function, the corresponding icon will turn on.
- (2) In power-off interface, press “ ” button can enter the function selection interface. In the power-off status, only ventilation function can be set.
- (3) Holiday function is conflicting with timer and weekly timer functions. If either one of the functions is activated, the other function would be canceled automatically.
- (4) Some functions above are only available for specific unit, please subject to actual product.

### 4.5.1 Setting of Sterilization Time

- (1) Press “ ” to enter the setting interface of sterilization, and then the sterilization icon “ ” and setting icon “SET” are constantly on.
- (2) “ON” or “OFF” in temperature area are flashing, press “ ” or “ ” button to set ON/OFF of sterilization function. When it displays “ON” it refers to sterilization is activated, when it displays “OFF” it refers to the sterilization function is turned off, when “ON” or “OFF” icon flickers, sterilization interface “d XX” display the rest days of sterilization.
- (3) Press “ ” button, and then “sterilization cycle” flickers, press “ ” or “ ”
- (4) Button to adjust sterilization cycle, then “d XX” displays the sterilization cycle.
- (5) Press “ ” button again, the “sterilization start time” flickers, press “ ” or “ ” button to adjust the sterilization start time.
- (6) When conducting sterilization, the sterilization icon “ ” flickers in main interface.
- (7) During setting, press “ ” button or if there is no button operation for 20 seconds, it will automatically return to main interface and complete the setting of sterilization time.

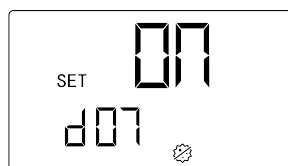

Fig.4.5-1 Display of sterilization cycle

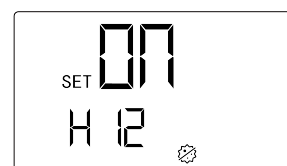







Fig.4.5-2 Display of sterilization start time

## Notes:

- ① Sterilization cycle: The setting value means the sterilization will be conducted how many days once.
- ② When the sterilization cycle is set as 0, it will conduct sterilization immediately and shield the setting of start time.
- ③ Sterilization time should be set within the timer ON time; otherwise the sterilization function will fail.
- ④ Enter sterilization setting interface, when “ON” or “OFF” flickers, it displays the rest days of sterilization.

### 4.5.2 Setting of Holiday Time

- (1) Press “” to enter holiday setting interface, the holiday icon “” and setting icon “SET” are on.
- (2) Press “” button, “days of holiday” flickers, press “” or “” button can adjust the days of holiday;
- (3) After setting the holiday, back to the main interface, it will display the rest days of holiday and holiday icon.
- (4) During setting, press “” button or if there is no button operation for 20 seconds, it will automatically return to main interface and complete the setting of holiday time.

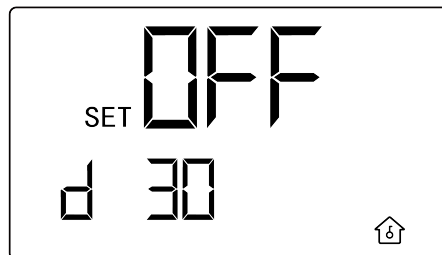

Fig.4.5-3 Setting of holiday time

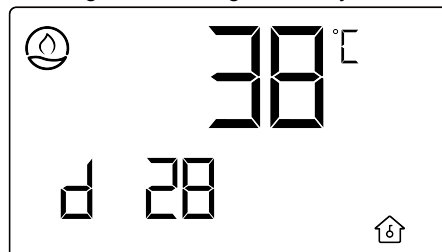





Fig.4.5-4 Display of main interface after setting holiday

## Notes:

- ① After activating holiday mode, turn off the unit can quit the holiday function.
- ② After activating holiday mode for 1 hour, you can operate the set temperature, turn on and off the BOOST function, or quit the holiday function.

### 4.5.3 Setting of Sunflower and Ventilation Functions

- (1) Press “” to enter function setting interface.
- (2) When setting sunflower function, the sunflower icon “” and setting icon “SET” are on.
- (3) When setting ventilation function, the ventilation icon “” and setting icon “SET” are on.

- (4) “ON” or “OFF” in temperature area are flicker, press “△” or “▽” button can turn on or turn off related function.



Fig.4.5-5 Sunflower function is on



Fig.4.5-6 Ventilation function is on

## 4.6 WiFi Function Setting

You can use “Gree+” App to control it, please scan the QR code in the home page to download it.

Only common functions of WiFi wired controller can be set through App: ON/OFF, Boost mode, set temperature, timer ON/OFF, holiday, sterilization, and can view the information of power consumption, heat production and COP.

If you use the App for the first time, please reset WiFi at first (restore ex-factory setting for WiFi).

When the wired controller is ON/OFF, long press “☐☐” + “△” buttons for 5 seconds, the prompting sound will occur 3 times and the wired controller will display “YES” for 5 seconds, WiFi reset is successful.

If there’s WiFi communication error, after long press “☐☐” + “△” buttons for 5 seconds, the prompting sound will occur 2 times and the wired controller will display “JF” for 5 seconds, the current reset is invalid.

## 4.7 Other Functions

### 4.7.1 Child Lock Function

In the ON state or OFF state without error, press “△” and “▽” buttons simultaneously for 5 seconds, the wired controller will enter into child lock function, the LCD will display “🔒”; press “△” and “▽” buttons simultaneously for 5 seconds again can quit the child lock function.

Under child lock status, there will be no response for pressing other buttons. If the function is set before power failure, after re-energizing the unit, the unit will still in child lock mode.

### 4.7.2 SG Function

- (1) SG01 state: the unit keeps off and will not conduct heating (except necessary anti-freeze demand), you can set the ON and OFF of SG01 in special parameter setting to enable the default ON state of SG01. After the SG01 is off, the state of SG01 will operate according to the state of SG02.

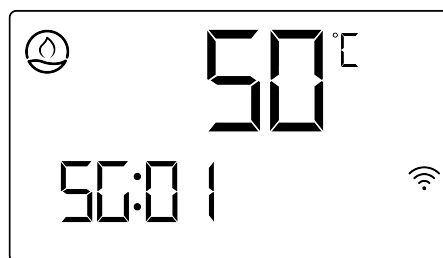

Fig.4.7-1 SG01 display

- (2) SG02 state: normal operation of unit.

- (3) SG03 state: it conducts heating control at a set value which is relatively higher than normal set temperature. When in SG03 state, the set temperature of SG03 state can be adjusted.

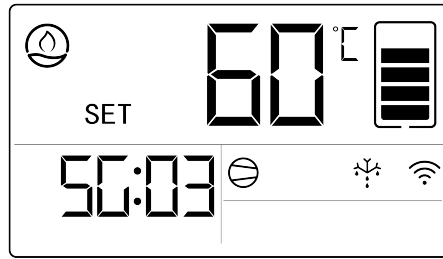

Fig.4.7-2 Display of SG03

- (4) SG04 state: it conducts heating control at a set value which is higher than the set temperature of SG03 state. When in SG04 state, the set temperature of SG04 state can be adjusted.

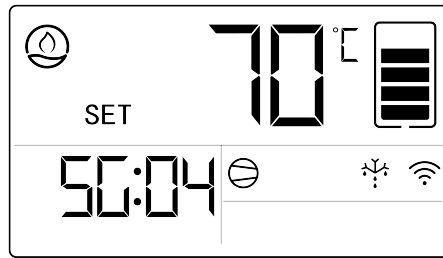

Fig.4.7-3 Display of SG04

### 4.7.3 Special Parameters Setting

- (1) In ON or OFF state interface, press and hold “” + “” buttons for 5 seconds, temperature area displays “00”.
- (2) When the system parameters inquiry interface is “00”, press and hold “” + “” buttons for 5 seconds, temperature area displays “E00”.
- (3) When the engineering parameters interface is “E00”, press and hold “” + “” buttons for 5 seconds, temperature area displays “F00”.
- (4) Press “” or “” button can adjust the value of special parameters;
- (5) Press “” button to select special parameters value.
- (6) Press “” or “” buttons to adjust the parameter option “01” or “00” of special parameter value.
- (7) Press “” button to confirm the parameter option, then the setting is done.

Table 4.7-1 Instruction for Special Parameters

Special Parameters	Special Parameter Value	Parameter Option	Instruction	Remarks
ON/OFF memory after power failure	E01	01	ON/OFF memory after power failure	Settable in both ON and OFF states
		00	No ON/OFF memory after power failure	
Temperature display transition Setting	E02	01	Fahrenheit (°F)	Settable in both ON and OFF states
		00	Celsius (°C)	
Electric heating enabling	E03	00	OFF	Settable in both ON and OFF states
		01	ON	

Special Parameters	Special Parameter Value	Parameter Option	Instruction	Remarks
Resume to Ex-factory Setting	E12	01	Resuming to ex-factory setting of wired controller is on	Settable in OFF states
		00	Resuming to ex-factory setting of wired controller is off	
Timer 2 type	E16	00	Timer ON/OFF 2 displays that 24:00 is clock timer	Settable in both ON and OFF states
		01	Timer ON/OFF 2 displays that 07:01 is weekly timer	
Holiday temperature	E21	Adjust within the range of 2~60°C		Settable in both ON and OFF states
SG01 enabling	E22	00	OFF	Settable in both ON and OFF states
		01	ON	
Fan speed compensation	E26	Adjust within the range of 0~6		Settable in both ON and OFF states
Ventilation fan speed	E27	Adjust within the range of 100~Maximum (The maximum value is based on the actual unit.)		Settable in both ON and OFF states
Function status value	F06	Settable within 0-15		Settable in OFF states
Clear of energy consumption data	F19	00	Not clear	Settable in both ON and OFF states
		01	Clear	

Notes:

- ① Resuming to ex-factory setting is available only in the OFF state.
- ② During the setting, press “” button or no operation for 180 seconds, the unit will automatically quit the setting, and the setting is invalid.
- ③ Except for the aforesaid special parameter setting, other special parameter setting can only be set by installing and debugging personnel, please do not alter by yourself, otherwise it may cause malfunction of unit.

## 4.8 Reset to Ex-Factory Setting

If the functions of unit cannot work well due to ex-factory setting is altered by misoperation, user can reset to ex-factory setting via wired controller.

Method 1: press and hold “” button for 5 seconds, the unit will resume to ex-factory setting. This operation is only valid for some units.

Method 2: please set according to “Special Parameters Setting” section.

## 4.9 Display of Energy Consumption

This unit can calculate and display energy consumption information through relevant parameters, including power consumption and heat production data. The purpose of collecting relevant energy consumption data is to facilitate users to view the current energy consumption information of the unit through quantifiable data. The relevant energy consumption data needs to be approved by the user through relevant parameter settings before it can be stored inside the unit. If the user needs relevant

displays, they can follow the following steps to set them:

- (1) For displaying energy consumption, first set the F06 in the special parameter setting as 03. If energy consumption data does not need to be displayed, set the F06 value to 00 and the unit will not be calculating energy consumption data.
- (2) For engineering parameter F06 settings, please refer to the section “Special Parameter Setting”.
- (3) If the energy consumption data need to be cleaned out, please set the F19 in the special parameter value as 01, the value of F19 has been restored to 00, indicating successful data deletion, Setting method for F19 parameter value.
  - ① Press “”+“” for 5 seconds, the temperature area will display “00”.
  - ② Press “”+“” for 5 seconds, the temperature area will display “E00”.
  - ③ Press “” + “” buttons for 5 seconds, the temperature area will display “F00”, Press “” or “”, the temperature area will display “F19”.
  - ④ Press “” to switch to set parameter value, at this time, “00” in the clock area will flash. Press “” or “” to adjust “01”.
  - ⑤ Press “” for confirmation and complete setting.
- (4) The viewing method is as follows: in ON or OFF state interface, press and hold “” + “” buttons for 5 seconds, temperature area displays “00”.
- (5) Press “” or “” to adjust to “02”, and press “” to display the energy consumption data. Only specific unit can display the energy consumption, please subject to actual product.
- (6) In the display interface of energy consumption, press “” or “” can circularly switch among heat production- day, power consumption- day, COP- day, heat production- month, power consumption- month, COP- month, heat production- year, power consumption- year, COP- year.
- (7) For viewing detailed data of energy consumption, please connect “Gree+” App.

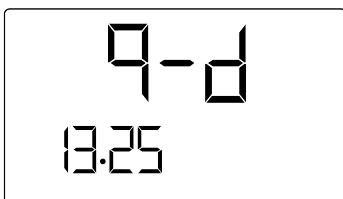

Fig.4.9-1 Heat Production-day

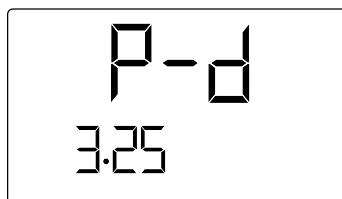

Fig.4.9-2 Consumption-day

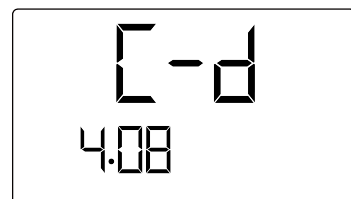

Fig.4.9-3 COP-day

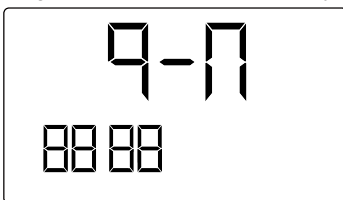

Fig.4.9-4 Heat production-month

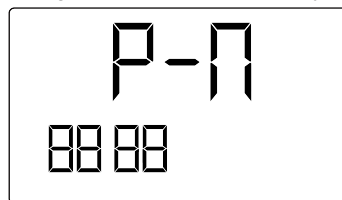

Fig.4.9-5 Power Consumption-month

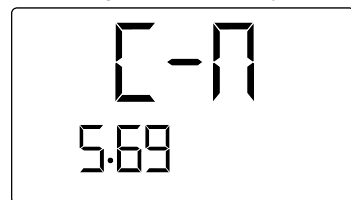

Fig.4.9-6 COP-month

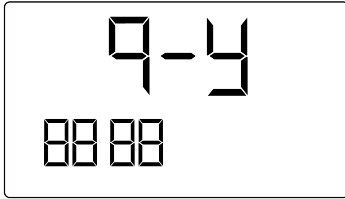

Fig.4.9-7 Heat Production-year

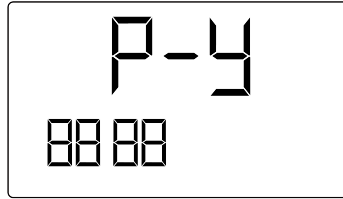

Fig.4.9-8 Power Consumption-year

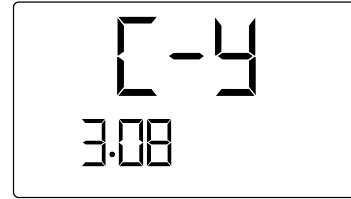

Fig.4.9-9 COP-year

## 4.10 Error Display

When errors occur during the operation of the system, timer display area will display the error code, and the temperature area displays the current water inlet temperature and outlet temperature, please turn off the unit and ask professional to repair.

When error occurs, except for the operation of ON/OFF, special parameter setting, other operations are not available.

If many errors occur simultaneously in the unit, the error codes will be displayed circularly.

The following figure shows communication error.

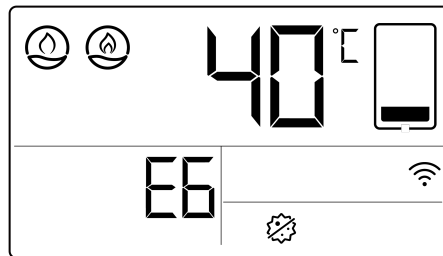

Fig.4.10-1 Display of error

# INSTALLATION

## 1 INSTALLATION FLOWCHART

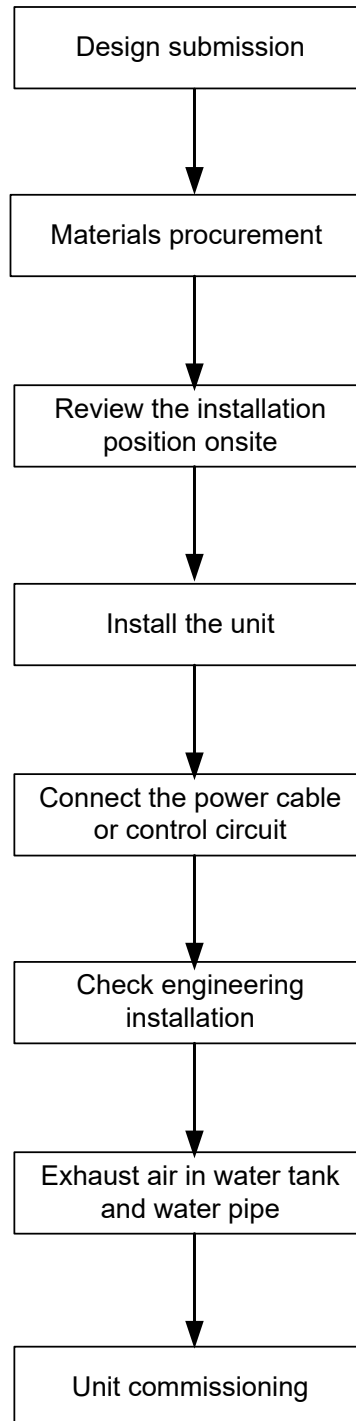

Fig.1-1 Flowchart for installing the unit



## 2 PREPARATIONS

### 2.1 Precautions for Engineering Installation

#### 2.1.1 Safety Requirement



#### WARNING! The R290 Refrigerant

- To realize the function of the unit, a special refrigerant circulates in the system. The used refrigerant is the fluoride R290, which is specially cleaned. The refrigerant is flammable and inodorous. Furthermore, it can lead to explosion under certain conditions.
- Compared to common refrigerants, R290 is a nonpolluting refrigerant with no harm to the ozoneosphere. The influence upon the greenhouse effect is also lower. R290 has got very good thermodynamic features which lead to a really high energy efficiency. The units therefore need a less filling.
- The appliance shall be stored in a room without continuously operating ignition sources (for example: open flames, an operating gas appliance or an operating electric heater.)
- The appliance shall be stored in a well-ventilated area.
- The appliance shall be stored so as to prevent mechanical damage from occurring.
- Ducts connected to an appliance shall not contain an ignition source.
- Keep any required ventilation openings clear of obstruction.
- Do not pierce or burn.
- Be aware that refrigerants may not contain an odour.
- Do not use means to accelerate the defrosting process or to clean, other than those recommended by the manufacturer.
- Servicing shall be performed only as recommended by the manufacturer.
- Should repair be necessary, contact your nearest authorized Service Centre. Any repairs carried out by unqualified personnel may be dangerous.
- Compliance with national gas regulations shall be observed.
- Read specialist's manual.



This marking indicates that this product should not be disposed with other house hold wastes throughout the EU. To prevent possible harm to the environment or human health from uncontrolled waste disposal, recycle it responsibly to promote the sustainable reuse of material resources. To return your used device, please use the return and collection systems or contact the retailer where the product was purchased. They can take this product for environmental safe recycling.



#### Caution

- All installation personnel must receive safety education and be assessed before construction is started. Once a delinquent behavior occurs, the relevant personnel must be liable for it.
- Personal and property safety must be put first during the entire construction process. Related national regulations on safety must be strictly followed to ensure personal and property safety.

#### 2.1.2 Importance of Engineering Installation

The installation process of the integral air source water heater involves installation of various parts, such as that of air inlet and air outlet ducts, drainage pipe, water pipes between the unit and indoor cool/hot water pipes, wired controller, power cord, and control circuit. Each installation phase must be treated with much care to ensure normal operation of the unit. Otherwise, user requirements cannot be met and more seriously, water leakage may be caused and the indoor decoration will be destroyed.

The following table lists problems that are inclined to occur during installation and their adverse effect.

No.	Installation Problem	Adverse Effect
1	The safety valve is not connected with a drainage hose or the connection is insecure.	Water leakage occurs and indoor decoration is destroyed.
2	PPR pipes are not properly welded.	The pipe is blocked. Hot water is unavailable as protection is started for the unit. Alternatively, the water flow rate is too low for daily use.
3	No filter is installed for the cool water inlet pipe.	
4	The unit is installed at a position with poor ventilation.	When the ambient temperature is high, high-voltage protection may be started and the unit stops.
5	The unit is not securely fixed or is installed on an external wall.	The unit may topple over or drop down, which may have severe results.
6	The unit is not connected with a drainage pipe.	Condensate water is discharged at random. Complaints may be generated.
7	The pipes are not provided with thermal insulation or thermal insulation is poor.	The water temperature fails to meet user requirements due to heat loss.
8	Tap water is unavailable or the water pressure is too low or too high while no remedial measures are taken.	The unit fails to work and complaints are generated due to unavailability of hot water.
9	The communication control cable is not properly protected.	The communication cable is short-circuited or disconnected and the unit fails to start due to communication failure.

### 2.1.3 Collaboration during Installation

The installation process requires collaboration with aspects such as building, structure, electric, water supply and drainage, fire control, and decoration. Layout of the piping shall not affect the automatic spray header for fire extinguishing and should be well designed to go with the electrical device, lighting, and indoor decoration.

#### 2.1.3.1 Collaboration with Civil Engineering

- (1) Holes, casing pipes, and installation positions for drainage standpipe must be reserved. Cable pipes must be laid in advanced.
- (2) Installation positions for the unit must be reserved and foundation must be prepared. The installation position for the unit must meet requirements on weight bearing, ventilation, and maintenance.
- (3) If no holes are reserved, holes can be drilled when required. Holes drilling on the spandrel girder or load bearing wall is prohibited.

#### 2.1.3.2 Collaboration with Decoration Engineering

Pipes for ventilation, cool water, hot water, and water return (If backwater is needed) must be laid in advance. Interfaces for ventilation, cool water, hot water, water return, and water drainage must be reserved. All pipelines, valves and pipe joints, etc. must be insulated. It is recommended that the thickness of the insulation pipes is not less than 15mm.

#### 2.1.3.3 Collaboration with Electrical

- (1) Circuits for the unit must be reserved with proper power type and power use capacity.
- (2) The power cable and air circuit breaker meets requirements of the unit as well as national safety regulations.
- (3) The regional power supply should comply with national standards in terms of voltage fluctuation and interference noise. Any incompliance found must be rectified through joint efforts.

## 2.2 Before Installation

### 2.2.1 Unpacking

When unpacking ensures the following items are included:

Main Unit	The Main unit including the heat pump and storage tank (integral).
Safety valve	Pressure-relief device (May be pre-fitted)
Condensation Tube	Used for draining condensation from the unit
Owner's manual	In-depth installation & maintenance detail on the product
Owner's manual (Controller)	In-depth control descriptions detail on the product

### 2.2.2 Transporting

The following should be adhered to when transporting the unit:

- (1) Transport the product to the installation site using a fork-lift truck or pallet truck.
- (2) Don't incline the unit more than 25° from vertical when moving, and keep it vertical when installing.
- (3) Avoid scratching or damaging the unit by using protective coverings where applicable.
- (4) As this unit is heavy it needs to be carried by two or more persons, to avoid injury and/or damage.

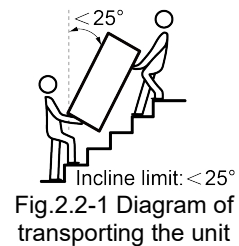

## 2.3 Design Drawing Review

The installation personnel shall carefully read the design scheme and drawing provided by the design personnel. The design intent should be completely understood and construction items should be checked onsite. If any question exists, rational opinions should be put forward in a timely manner.

Items to be checked during drawing review:

No.	Item	Check Result
1	The unit is provided with a condensate water drainage pipe.	
2	The unit installation position meets space requirements for heat exchange and maintenance.	
3	The specification, type, and control method of the power cord meet design requirements of the unit.	
4	Preparation, total length, and control method of the control cable meet design requirements of the unit.	



The construction personnel shall strictly follow the design drawing. During construction, if any design requirement cannot be met and needs to be changed, the design requirement can be changed upon approval of the design personnel and a written document should be formulated accordingly.

## 2.4 Installation Material Selection

### 2.4.1 Precautions

- (1) If the brand and specifications of installation materials are specified by the user, user requirements must be met. If not specified, the installation materials purchased shall follow national regulations and meet quality requirements.
- (2) The certificate of quality or inspection report must be provided for materials and devices used for installation.

- (3) A fire-proof inspection certificate must be provided for products with fire-proof requirement and these products must comply with national regulations and mandatory standards.
- (4) When environmental-friendly materials are required by the user, all materials shall meet national environment-protection requirements and relevant certificates must be provided.

## 2.4.2 Requirements on Installation Material Selection

### 2.4.2.1 Water Pipe Selection

- (1) Selection of PPR water pipe

Generally, PPR pipes are adopted as hot water pipes for their various advantages such as light weight, corrosion resistance, scaling-free, long service life, easy installation, heat preservation and energy-saving and good heat resistance. PPR pipes are connected by hot melting. Common series and specification are listed in the following table.

Nominal Outside Diameter Dn	Average Outside Diameter		Pipe Series				
			S5	S4	S3.2	S2.5	S2
	Maximum	Minimum	Nominal Wall Thickness				
20	20.0	20.3	-	2.3	2.8	3.4	4.1
25	25.0	25.3	2.3	2.8	3.5	4.2	5.1

**NOTE:** Generally, S4 series pipes are adopted for cool water and S2.5 series pipes are adopted for hot water.

- (2) Selection of condensate water pipe

- 1) Rigid PVC pipes are recommended for water drainage as they are easy to purchase and install.
- 2) The certificate of quality and quality inspection report must be provided.
- 3) Specifications and wall thickness:

Rigid PVC pipe (PVC-U pipe): dn 32 mm × 2 mm, dn 40 mm × 2 mm, dn 50 mm × 2 mm, where dn indicates external diameter.

### 2.4.2.2 Selection of Thermal Insulation Materials

- (1) The quality inspection report and certificate of quality must be provided for thermal insulation materials and products. Technical specifications and performance of these materials and products must comply with related technical standards and design regulations.
- (2) Flexible closed foam rubber and plastic materials are recommended for thermal insulation.
- (3) Fire-retardant grade of the thermal insulation materials must be A (noncombustible).
- (4) The heat resisting capacity of the thermal insulation materials shall not be lower than 120°C.
- (5) Wall thickness of the pipe thermal insulation materials shall not be less than 15 mm.

### 2.4.2.3 Selection of Communication Cable

The wire controller is installed on the front panel of the unit by default. When it needs to be adjusted to other places outside the unit, it is recommended that the length of the communication cable between the wired controller and the unit can't be more than 8m. Twisted pairs or shielded twisted pairs that are already configured for the unit must be adopted as the communication cable and control cable.

### 2.4.2.4 Selection of Power Cord

A copper conductor must be adopted as the power cord, which shall comply with related conductor standards and meet the unit's requirement on current-carrying capacity.

## 3 INSTALLATION OF PRODUCT

### 3.1 Safety Notices for Installation, Maintenance and Relocation of Unit

- (1) Please read the instructions for use, installation and maintenance carefully before use.



- (2) If the product needs to be installed, moved or maintained, please contact our designated dealer or local service center for professional support. Users should not disassemble or maintain the unit by themselves, otherwise it may cause relative damage, and our company will bear no responsibilities.
- (3) During installation or relocation of the unit, the refrigerant circuit can't be mixed with the substances (such as air, other refrigerants, etc.) except the specified refrigerant, otherwise it will cause the system pressure to rise, and the compressor may burst and cause injury.
- (4) If the user use their own installation materials for installation, we may not be liable to bear relevant legal responsibilities for all the losses incurred by pipeline leaks, crashes, and poor installation that affect the normal operation and use of this product.
- (5) Avoid installation in a small room to prevent the refrigerant concentration in the room from exceeding the limit when the refrigerant leaks, which may cause hypoxia or suffocation.

### 3.2 Unit Installation Diagram

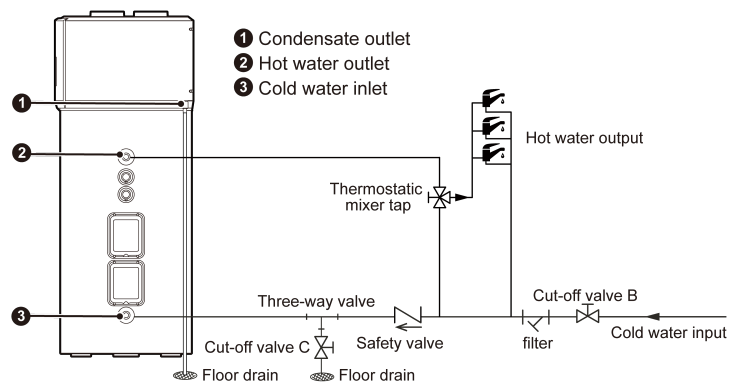
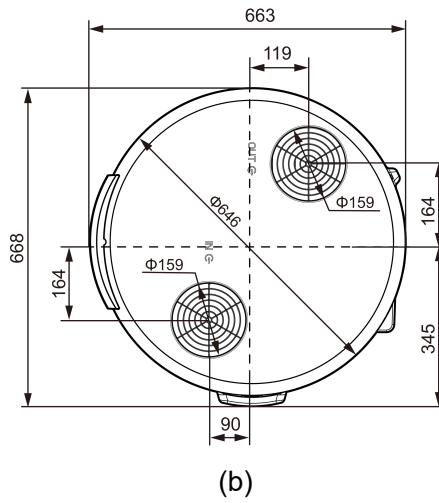
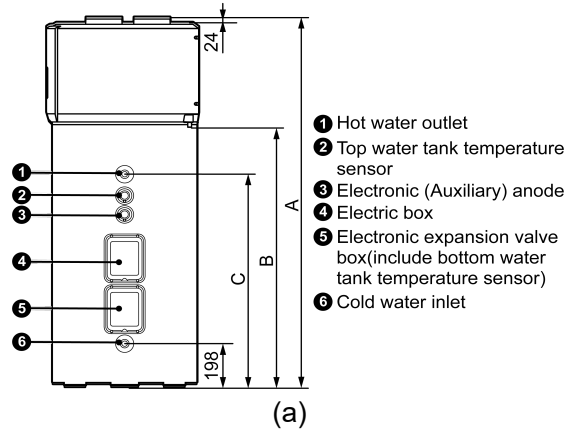

Fig.3.2-1 Unit Installation Diagram

### 3.3 Structural Dimension

Unit: mm



Parameter \ Model	GRS-1.5Pd/TD200ANpA-K	GRS-1.5Pd/TD270ANpA-K
A	1667	1947
B	1177	1459
C	964	1235

### 3.4 Requirements of Installation Dimension

Unit: mm

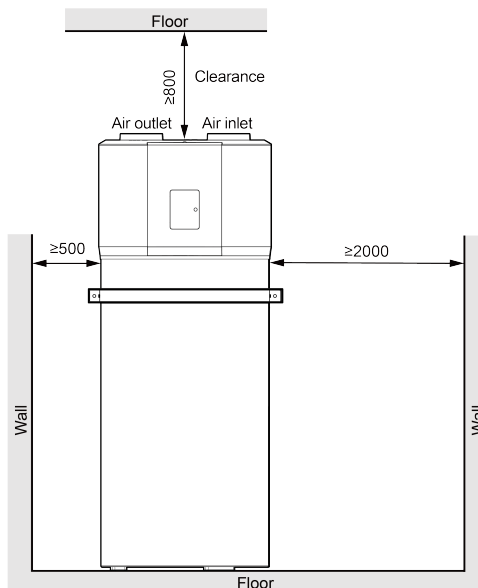

### 3.5 Installation Requirements

- (1) Ensure that the sound and airflow of the unit will not affect people, animals, or plants, etc.
- (2) Ensure that the unit has good ventilation. If a canopy is installed to protect the unit, it should be noted that heat dissipation and heat absorption shouldn't be affected.
- (3) The unit should be installed in a place with a solid foundation and make sure that the unit is installed upright. The impact of strong wind, typhoon and earthquake or other natural disasters should be fully considered, and the installation should be reinforced.
- (4) Ensure the reliable connection of the drain pipe of the unit and lead the drain pipe to a proper place for drainage.

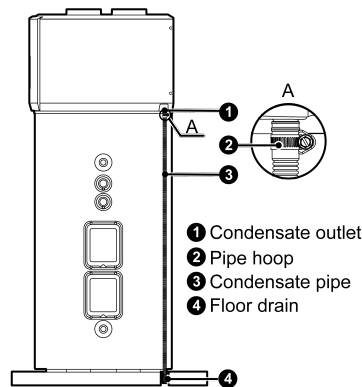

Fig.3.5-1 Drainage Connection Diagram

- (5) The unit must be installed in a place with rain and sun shading devices where it can be sheltered from rain.
- (6) The unit and water system piping and valves should be installed as far as possible in the ambient temperature above 0°C, and preferably installed near the main hot water point.
- (7) In order to avoid inconvenience or property damage to user due to water leakage caused by improper connection of water pipe or normal water release of safety valve, it is forbidden to install the unit in a place without good drainage.
- (8) The unit shall be located upright. The installation ground must be flat and spacious, and the foundation shall be solid enough to bear four times of the weight of the unit after the unit being filled with water. It is strictly forbidden to hang the unit or hang it on an external wall. When installing the unit, it's necessary to use fixing belt to protect the unit. If the unit is installed in areas with strong winds, typhoons, or earthquakes, in addition to using fixing belt for installation, additional reinforcement measures must be taken to prevent the unit from tipping over under external forces, thus causing unnecessary unit damage or personal injury. The fixing belt of the unit only serves as an auxiliary fixation and cannot bear the weight of water tank.

### 3.6 Installation Requirements of Water System Pipeline

- (1) For water pipe, it is recommended to use the PPR pipe.
- (2) Each valve must be installed properly and the installation sequence must be consistent with the installation diagram of the unit.

- (3) The pipelines shall be laid centrally. Hot water outlet of the unit shall not be far from the place where the hot water is taken. There should be floor drain near the unit.
- (4) If the tap water contains impurities, a water filter must be installed.
- (5) The connecting parts of the water pipe must be sealed with tape to prevent water leakage.
- (6) All water system pipelines, valves and pipe joints, etc. must be insulated. It is recommended that the thickness of the insulation pipe is not less than 15mm.
- (7) When the installation environment temperature is below 0°C, the pipeline must be equipped with self-limiting temperature heater.
- (8) The pressure will gradually rise during the heating process of the water tank, and a small amount of water shall be discharged through the safety valve to relieve the pressure. If it is not installed or installed incorrectly, expansion, deformation or any other damage may occur to the unit, and even personal injury will be caused. It is forbidden to install a cut-off valve or check valve between the safety valve and the unit, otherwise the safety valve will not be able to relieve pressure. The safety valve must be connected to the drain hose and the connection must be reliable to prevent falling off; the drain hose shall be introduced into the floor drain naturally, and there cannot be bulges, entanglement, folding, etc. After connecting to the floor drain, the spare hose must be cut off so as not to cause poor drainage and the water in the hose will not be frozen in low temperature environment. The type of the safety valve is an external pressure relief valve. The discharge pipe connected to the safety valve (pressure-relief device) must be installed in a continuously downward direction and in a frost-free environment. And it is forbidden to block the exhaust hole of floor drain.

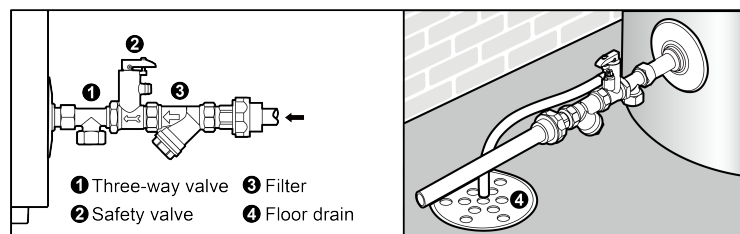

(a) Installation method 1(cold water inlet pressure = 0.1~0.5MPa)

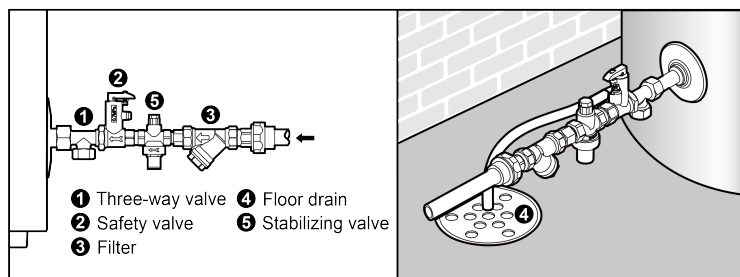

(b) Installation method 3(cold water inlet pressure >0.5MPa)

Fig.3.6-1 Safety valve installation diagram of cold water inlet pipe

For installation method 2, add stabilizing valve, ensure that the entering pressure of water tank is between 0.3~0.5MPa. The arrow direction of the stabilizing valve must be consistent with that of water flow.

- (9) The water quality for the air source water heater should comply with the local sanitation standard for the domestic drinking water and refer to the following water quality requirements.



Table 3.6-1 Water Quality Requirements

pH (25°C)	6.8~8.0	Turbidity (scattering turbidity unit)/NTU	<1
Chloride/(mg/L)	<50	Iron/(mg/L)	<0.3
Sulfate/(mg/L)	<50	Silica (SiO <sub>2</sub> )/(mg/L)	<30
Total hardness (calculated in CaCO <sub>3</sub> )/(mg/L)	<70	Nitrate (calculated in N)/(mg/L)	<10
Conductivity (25°C)/(μs/cm)	<300	Ammonia nitrogen (calculated in N)/(mg/L)	<1.0
Total alkalinity (calculated in CaCO <sub>3</sub> )/(mg/L)	<50	Sulfide/(mg/L)	Shall not to be detected

### 3.7 Installation Requirements for Pipeline of Wind System

This product can be equipped with two ventilation pipelines for indoor and outdoor ventilation. One pipeline is used to deliver outdoor fresh air into the room, and the other pipeline is used to discharge the air of the unit to the outside. When the airflow flows through the pipeline, the pipeline will create a certain resistance to the airflow. The greater the resistance is, the smaller the ventilation volume. Besides, the wind resistance of pipeline will increase if the length of pipeline is too long, the diameter is too small, and there are too many bends, thus reducing the ventilation volume. Therefore, please follow the following recommended principles for installation and design:

- (1) The nominal static pressure of the unit is 30Pa and the maximum static pressure is 60Pa.
- (2) PVC pipe is recommended for air duct to reduce the resistance of wind system. Generally, the length of each ventilation pipeline shall not exceed 5m.
- (3) Minimize the use of elbow in pipeline. The number of elbow in each pipeline shall be controlled within 5m( $A+C \leq 5m$ ;  $B+D \leq 5m$ ). The bending part of elbow should be designed as an arc to avoid 90° right angle bending.
- (4) The inner wall of pipeline is smooth, free from dust and wrinkles.
- (5) The difference in temperature between the air flowing through the pipe and the air in the installation room can cause condensation to form on the outside surface of the pipe. Insulation layers must be set on the outlet air duct, inlet (return) air duct and pipe joints to prevent heat leakage and condensation. The recommended thickness for insulation layer should not be less than 15mm. Glue the adhesive nails on the air duct, then attach the insulation cotton with a layer of tin foil paper, fix it with the adhesive nail cover, and finally seal the connection joint tightly with tin foil tape; other materials with good insulation effect can also be used for insulation.
- (6) The outlet and return air ducts should have iron brackets fixed on the prefabricated floor panels. Seal the air duct joints tightly with glue to prevent air leakage.
- (7) In order to prevent leak air from being extracted by recirculation, maintain a clearance( $\geq 220$  mm) between the ends of the air pipes.
- (8) The design and construction of air duct shall comply with relevant national and local engineering specifications.
- (9) The recommended distance between the edge of the return air duct and the wall is 150mm or more, and a filter screen needs to be added for the return air outlet.
- (10) The filter screen needs to be cleaned or replaced regularly. During design and installation, leave maintenance space at a side of air duct.

- (11) After installing the air duct or engineering filter screen, hands shall not touch the internal components.
- (12) The design and construction of air duct shall consider sound attenuation and vibration reduction. In addition, the noise source must avoid the crowds. Do not design the air vent above the user's head (in places such as office and rest area). If the users require the indoor noise to be as low as possible, just consider to connect duct silencers in series in the duct. There are many types of silencers, and please ask for professional guidance during selection. After installing a suitable silencer, the noise at the air outlet can be reduced.

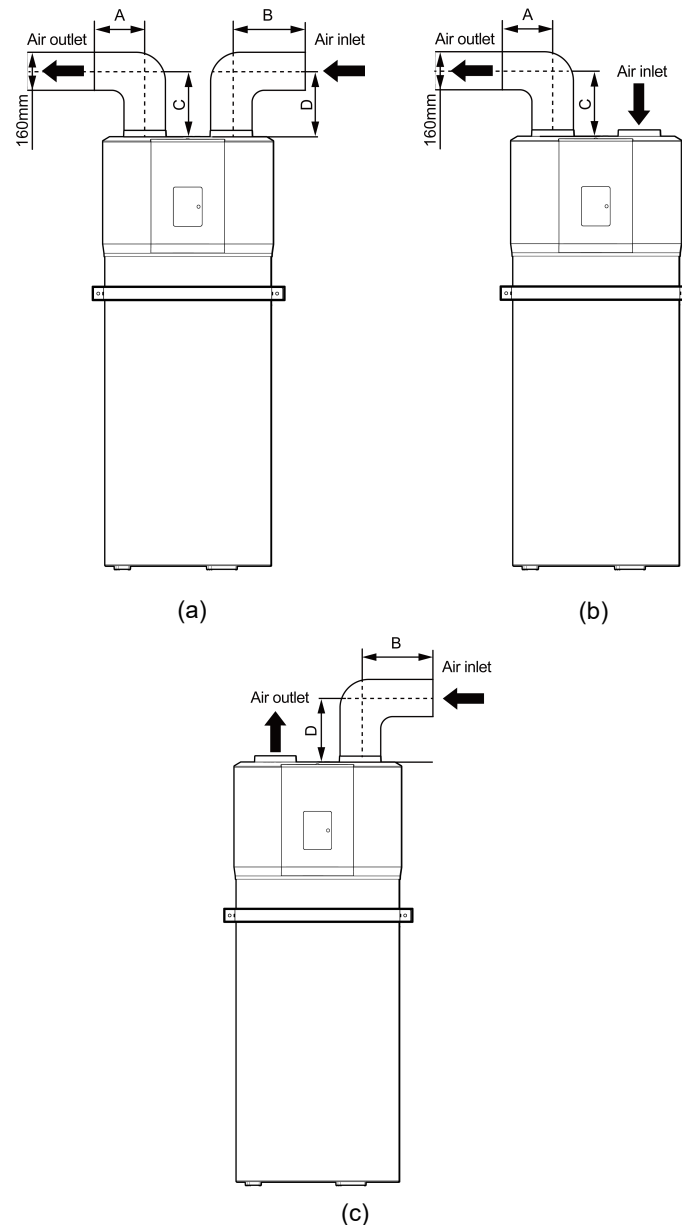

Fig.3.7-1 Installation diagram of air inlet and outlet ducts

### 3.8 Electrical Installation



#### WARNING!

- The appliance shall be installed in accordance with national wiring regulations, and installation of the unit must be done by qualified personnel.
- The power supply must comply with the specifications on the nameplate. The carrying capacity of the power supply, wires and sockets should be confirmed before installation.
- The fixed circuit must be equipped with a residual current device (RCD) and a circuit breaker with sufficient capacity to ensure that all poles are disconnected from the power supply when necessary. The action time of the residual current device (RCD) should be less than 0.1s.
- The unit must be grounded reliably. The grounding wire should connect with special device of buildings.
- The unit circuit must be at least 1.5m away from any inflammable surface.
- Separate fixed device for power supply must be used, and its structure shall match the power supply of water heater, and comply with relevant national and local standards.
- Do not use socket converters, cable extension cords or wiring boards to accommodate the power cord of water heater, no switch to other power cords to accommodate family power. Connect wires for the water heater separately and do not share the same circuit with other electrical appliances.
- Please see the electrical schematic diagram for exact details.
- If the power cord is damaged, it must be replaced by the manufacturer, its service agent or similarly qualified persons in order to avoid a hazard. It is not allowed to reconnect the damaged power cord.

#### 3.8.1 Selection of Power Cord Diameter and Circuit Breaker

Table 3.8-1 Unit Power Cord Configuration Table

Model	Power supply	Minimum sectional area (mm <sup>2</sup> ) of power cord			Circuit breaker (A)	Fuse capacity (A)
		L	N	PE		
GRS-1.5Pd/TD200ANpA-K	220-240V~ 50/60Hz	1.5	1.5	1.5	16	16
GRS-1.5Pd/TD270ANpA-K						

#### 3.8.2 Wiring Diagram

(1) The external wiring diagram of the unit is as follows. For the internal wiring diagram, please refer to the circuit diagram attached on the machine.

(2) The following two installation methods can be used for the display board (wire controller).

If the wire controller needs to be installed in an indoor area other than the unit's panel, its wiring method should be in accordance with method I in the figure.

If the wire controller needs to be installed on the unit's panel, its wiring method should be in accordance with method II in the figure.

(Note: Connect according to either method I or method II)

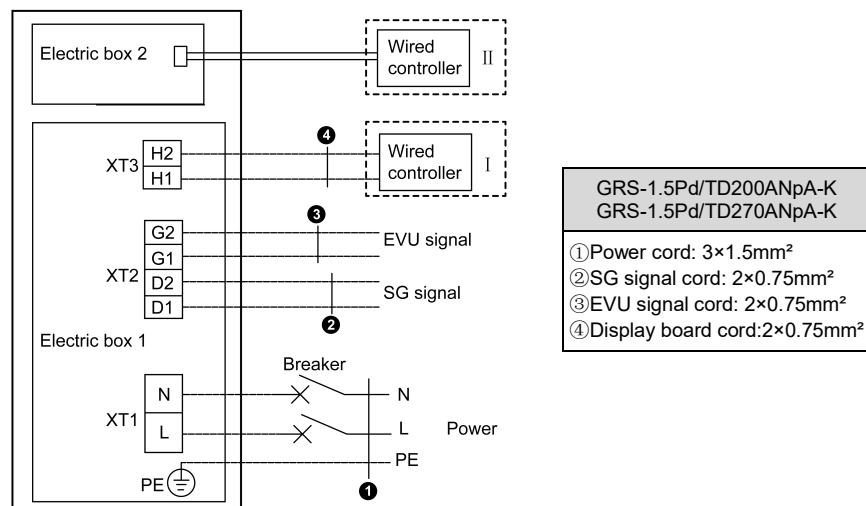

Fig.3.8-1 External wiring

### 3.8.3 Electrical Wiring and Connection Requirement

- (1) After completing wiring connection, the power cord and communication wires must be tightly pressed with a fixed wire clamp. The fixed wire clamp should be pressed on the outer sheath of the connection wire.
- (2) When arranging wiring connection for the external unit, the communication cord of wired controller shall be separated from the power cord. The minimum distance between the parallel wires shall be greater than 20cm. Otherwise, the communication of the unit might be abnormal. The strong and weak wires shall be covered separately with wire sleeves.

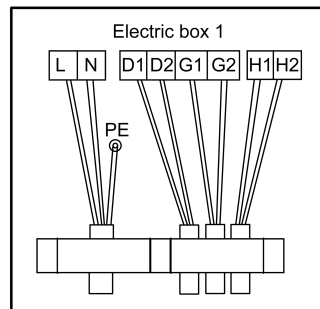

Fig.3.8-2 External wiring and fixing figure

### 3.9 Wired Controller Installation

The wire controller is installed on the front panel of the unit by default. When it needs to be adjusted to other places outside the unit, it is recommended that the length of the communication cable between the wired controller and the unit can't be more than 8m.

The following are the detailed requirements and installation methods of the wire controller.

#### 3.9.1 Installation and Engineering Commissioning of Wired Controller

Unit: mm

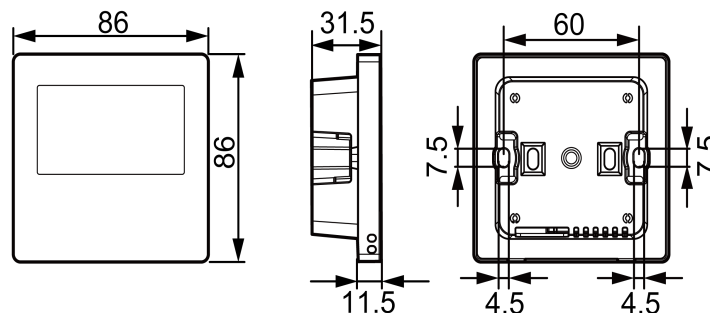

Fig.3.9-1 Dimensions of Wired Controller

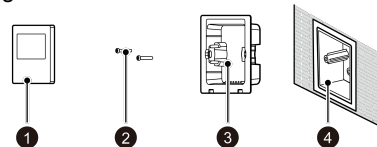

Fig.3.9-2 Parts and Components of Wired controller

Table 3.9-1 Parts and Components Introduction

No.	①	②	③	④
Name	Wired controller	Screw M4×25	Soleplate of wired controller	Junction box installed inside the wall
QTY	1	2	1	Prepared by user

## 3.9.2 Installation of Wired Controller

### 3.9.2.1 Instruction of Interface

Table 3.9-2 Instruction of Interface

Interface	A/B
Type	485 communication interface (nonpolar)
Parameter	24V DC input

### 3.9.2.2 Requirement for Installation Location

- (1) Please do not install the wired controller in the position where is likely to be splattered with water.
- (2) Please do not install the wired controller near the high-temperature object or under direct sunlight.
- (3) Before installation, please first cut off the power source of heavy current wire embedded inside the installing hole, hot-line work is not allowed during the whole course of the installation.
- (4) In order to prevent malfunction due to electromagnetic interference or related reasons, please pay attention to the following notices:
  - 1) Make sure that the interface of communication wire is correctly connected; otherwise it may cause communication error.
  - 2) Communication wire of wired controller should be separate with the power cord and outdoor connecting wire, the minimum distance should be over 20cm, and otherwise it may cause communication error of unit.
  - 3) If the product is installed in the position where is likely to be interfered by electromagnetism, the signal wire of wired controller must adopt STP wire.
- (5) The wired controller should only be installed indoors or in the unit, the working temperature range is  $-7^{\circ}\text{C}\sim 45^{\circ}\text{C}/19^{\circ}\text{F}\sim 113^{\circ}\text{F}$ .

### 3.9.2.3 Indoor Installation

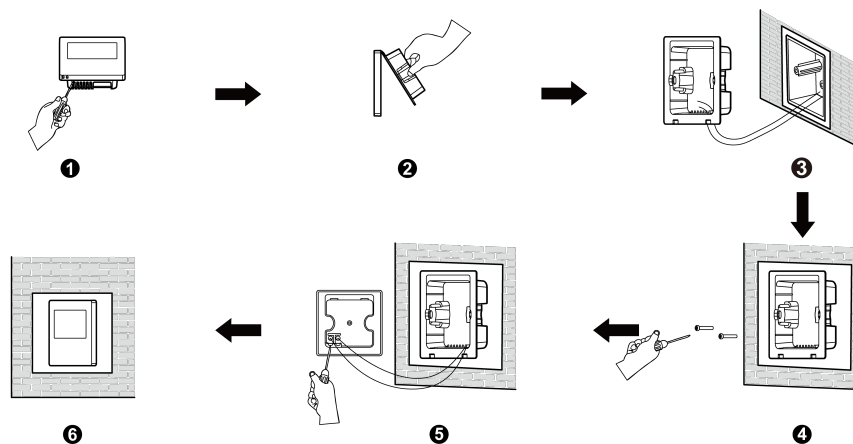

Fig.3.9-3 Installation of wired controller

The above figure shows the simple installation of wired controller, and the following points should be noted:

- (1) Before installation, please cut off the power source first, hot-line work is not allowed during the whole course of installation.
- (2) Pull out the 2-core STP wire inside the installing hole of wall, and thread the wire through the wire connecting hole in the back of soleplate of wired controller.

- (3) Stick the soleplate of wired controller on the wall, use screw M4×25 to fix the soleplate into the installing hole of wall.
- (4) Connect the 2-core STP wire to the two wiring terminals respectively in the back of wired controller, and screw up the screws.
- (5) Buckle the wired controller panel and wired controller soleplate together, the installation is done.
- (6) The length of the communication cable between the wired controller and the unit can't be more than 8m.

### 3.9.2.4 Install in the Unit

The wired controller can be directly installed in the unit by installation personnel.

### 3.9.2.5 Removal

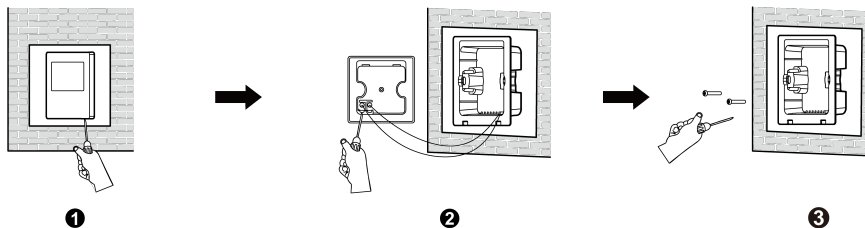

Fig.3.9-4 Removal of Wired Controller



#### Caution!

For removing wired controller in figure ①, please use slot type screwdriver for easily lever the panel and soleplate of wired controller. If the rear cover of wired controller is required to remove, please unscrew the screws of wiring terminals first.

## 3.10 Detailed Installation Instructions for Unit Fixing Belt

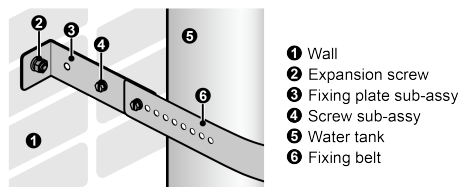

Fig.3.10-1 Introduction to Related Parts of Fixing Belt

Table 3.10-1 Detailed Operation of Installing Fixing Belt

<p>Step 1: Confirm the installation location of the fixing belt. The installation height H of the expansion screw can be appropriately increased or decreased according to actual needs, but it must be ensured that the fixing belt cannot press against the gaskets at each pipe port of the water tank of the unit during installation.</p> <p>Step 2: Install expansion screws. Install the expansion screws on the wall.</p>	<p>Step 3: Install the fixing belt. Install one end of the fixing belt on one of the fixing plate sub-assy.</p> <p>Step 4: Install the fixing plate sub-assy. Install the two sets of fixing plate sub-assy on the expansion screws respectively.</p>	<p>Step 5: Fix the unit. Move the unit to the fixing plate sub-assy, select the appropriate connection holes on the fixing belt according to the actual installation situation, and use the screw sub-assy to complete the fixing.</p>

## 4 COMMISSIONING OPERATION



### WARNING!

- Safety measures must be taken for operation. All personnel involved in commissioning and maintenance must master the safety regulations of construction and implement them in strict accordance with the regulations.
- The electrician, welder and other special types of operators must get the permission for the corresponding post. When performing related operations on the equipment, the power supply of the whole unit must be cut off. Meanwhile, operate the unit in strict accordance with related safety requirements.
- All installation and maintenance operations must comply with the product design requirements and national and local safety operation requirements. Illegal operations are strictly prohibited.

### 4.1 Check before Commissioning

After the air source water heater is installed, be sure to check the unit according to the following table.

Table 4.1-1 Unit Installation Checklist

Items to be checked	What may happen if the installation is improper
Whether the unit is installed reliably	The operation of the unit produces noise or vibration, and even causes danger such as falling
Whether there are obstacles at the air outlet and air inlet of the unit	The unit operates abnormally
Whether the cold water inlet pipe and hot water outlet pipe use PPR pipes	Safety hazard may happen
Whether the safety valve of water tank is installed	The operation pressure of water tank is high and there may be safety hazard.
Whether a stabilizing valve is installed when the inlet pressure of water tank is too high	The operation pressure of water tank is high. The safety valve continuously discharges water and produces abnormal noise
Whether all parts of the water pipeline have been properly insulated	The performance of the unit may be affected and the pipeline may be damaged by freezing
Whether the power supply voltage is consistent with the product nameplate, and whether the wire type meets the regulations	The unit has malfunction or the parts are burned out

### 4.2 Trial Operation



### NOTE!

- The water tank of the unit must be filled with water before the unit can be powered on.

The whole unit can be debugged only after the unit has passed the installation inspection. The debugging steps are as follows:

- (1) Water recharge of the unit: refer to the installation tips label on the water tank of the unit to perform water recharge. Ensure that there is no water leakage in the pipelines, joints, etc.
- (2) Energization of the whole unit: After the unit is energized, observe whether the display of wired controller is normal. If there is no fault, it is normal.
- (3) System time calibration of wired controller: set the time according to the manual of the wired controller.
- (4) Operation of the whole unit: turn on the unit with the wired controller. When the wired controller displays heating icon, check whether the unit is operating normally. Normal judgement criterion: the fan is running normally, the whole unit is running stably without obvious vibration and abnormal noise. The unit can be delivered to the user after running for at least 20 minutes without abnormality.



### 4.3 Debugging for Air Volume

The unit is developed based on the outlet air static pressure of 30Pa. If the resistance of air outlet is

different, it will affect the air volume and performance of the unit. Therefore, during actual installation process, please pay attention to correct the resistance of air duct to maintain consistency between air volume and nominal value.

When the unit is installed, the air volume can be corrected by adjusting the engineering parameter E26 (compensation setting for fan speed) of the wired controller according to the actual situation.

(1) Setting method for E26 parameter value

- 1) Press “+“+“

(2) Relationship of E26 parameter value, static pressure and fan speed

- 1) If adjusting E26 to 00, static pressure is 0Pa, the fan speed will change along with the operation parameter of the unit (The unit doesn't connect with air duct);
- 2) If adjusting E26 to 02, static pressure is 20Pa;
- 3) If adjusting E26 to 03, static pressure is 30Pa;
- 4) If adjusting E26 to 04, static pressure is 40Pa;
- 5) If adjusting E26 to 05, static pressure is 60Pa.

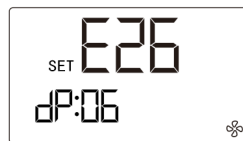

Fig.4.3-1 Display interface of E26

## 5 CHECKS BEFORE ACCEPTANCE

Checklist for Commissioning of Air Source Heat Pump Water Heater		
No.	Check Item	Pass
Unit	The heat exchange space for unit installation meets the related requirement.	
	A drainage ditch or outlet is available near the installation position to facilitate water drainage.	
	The foundation is solid and secure to ensure stable operation of the unit.	
	The unit must be installed in a horizontal manner without any tilt.	
	The safety check valve and drainage pipe are installed securely.	
	The safety check valve and drainage pipe are placed in floor drain for water drainage.	
	Cable diameter meets the unit's design requirement.	
	The circuit breaker and residual current device (RCD) meet the unit's design requirement.	
	Foundation of unit is solid. Vibration reduction and water drainage meets the related requirement.	
Controller	Insulation plastic pipes such as PPR pipes should be adopted as the inlet/outlet pipe for cold water and hot water. Length (L) of each section of insulation pipes is larger than or equal to $70 \times R^2$ ( $L \geq 70 \times R^2$ , R indicates the internal radius of pipe).	
	The wire controller is installed on the front panel of the unit by default. When it needs to be adjusted to other places outside the unit, the communication cable of the wired controller is 20cm or more away from the strong electricity cable.	
	The wired controller is not installed in a place with high temperature and high humidity, such as the kitchen and bathroom.	
	The wired controller is not installed outdoor.	



## 6 COMMON PHENOMENA

Phenomenon	Cause
The displayed water temperature decreases significantly but hot water is still available.	The temperature sensor that shows the water temperature is located in the middle-upper part of the tank and only senses the local hot water temperature at this location. In the process of using water, when the displayed water temperature decreases, the part of the water tank higher than the position of this sensor can still release hot water with temperature higher than the current displayed water temperature, about 1/5 to 1/3 of the water tank.
The displayed water volume decreases significantly but hot water is still available.	The unit estimates the hot water volume through the temperature of the two temperature sensors in the middle-upper part and middle-lower part of the water tank. It is a rough judgment, and the water volume display bar is for reference only. In the process of using water, when the water quantity display bar changes from one bar to empty, there is a certain amount of hot water available in the tank, about 1/5 to 1/3 of the water tank.
The displayed water temperature decreases significantly but the unit doesn't operate	Please check whether the timer or preset function is enabled. With this function, the unit only operates within the set time range. If the function is enabled, please calibrate whether the system time and function opening time are accurate, or cancel this function; Please check whether the "Sunflower" energy-saving heating function is enabled. This function only produces hot water in the period with high ambient temperature every day to achieve energy saving purposes. If it cannot meet your needs and habits, please cancel this function; Please check whether the "Holiday" functions are enabled. The above functions can be cancelled by setting the wired controller or restoring the factory settings.
The unit is often turned on for heating	In actual use, the hot water is in the middle-upper part of the water tank and the cold water is in the middle-lower part of the water tank. The unit will automatically judge to start heating according to the cold water temperature in the middle-lower part, which is not related to the displayed water temperature value. The times that the unit starts heating will not lead to a significant difference in energy consumption, and the hot water is stored in the water tank.
The volume of hot water decreases in winter	The hot water stored in the water tank will not actually reduce, but because of the low temperature of tap water in winter, more hot water in the tank needs to be consumed when bathing. It is recommended to appropriately increase the set water temperature or go bathing in turns with suitable intervals.
Water heating time is long	The unit is a storage type water heater equipped with a large water tank volume, and it takes a certain time to heat a whole tank of water. Water heating time in winter is longer than that in summer, it is recommended to heat water in advance or keep the unit on all day for use.
The unit is frosting.	The ambient temperature is low and frosting is a normal operation process. The unit will defrost regularly to ensure reliable operation.
Condensate flows out from the unit.	It is a normal phenomenon when the unit is running.
A small amount of water is discharged from the safety valve.	During heating operation, the water tank will discharge a small amount of water through the safety valve to relieve the pressure. This is a normal phenomenon.
<b>After-sales Service</b>	
The list of common fault codes can be found in the manual of the wired controller. If the product you purchased has a quality problem or a fault is displayed on the wired controller or other conditions shall be solved, please contact our designated dealer or local service center in time.	

## REPAIR

### 1 ERROR CODE

Table 1-1 Common Error Information

Error code	Error name	Error code	Error name
E1	System high-pressure protection	F4	Gas discharge temperature sensor error
E3	System less refrigerant protection/ low-pressure protection	Fd	Suction temperature sensor error
E4	Gas discharge protection	F6	Tube temperature sensor error
E5	Compressor overload protection	d5	Temperature sensor error of return pipe
E6	Communication error	FL	Bottom water tank temperature sensor error
E7	Communication error of backwater plate	FE	Top water tank temperature sensor error
C5	Jumper cap error	EF	Blockage protection for air inlet or air outlet
L7	Water flow (water pressure) switch error	d8	Temperature sensor error of water outlet of casing
E0	Water pump error protection (semi-direct heat type)	L6	Insufficient capacity, anti-high ambient temperature operation or operation protection for long period
U7	Abnormal reversing of 4-way valve or insufficient refrigerant	bH	Temperature sensor error of return pump
F3	Outdoor ambient temperature sensor error	—	—

Table 1-2 Drive Error Information

Error code	Error name	Error code	Error name
EE	EPROM storage chip error	AA	Inverter outdoor fan AC protection (input side)
ee	Inverter compressor driver storage chip error	AC	Inverter outdoor fan startup failure
H5	Inverter compressor driver IPM module protection	Ad	Inverter outdoor fan less phase protection
HC	Inverter compressor driver PFC protection	AE	Inverter outdoor fan driver current detecting circuit error
H7	Inverter compressor out-of-step protection	Ar	Inverter outdoor fan driver electric box temperature sensor error
Lc	Inverter compressor startup failure	AL	Inverter outdoor fan driver DC bus low-voltage protection or voltage drop error
Ld	Inverter compressor default phase protection	AJ	Inverter outdoor fan out-of-step protection
LF	Inverter compressor power protection	AH	Inverter outdoor fan driver DC bus high-voltage protection
PA	Inverter compressor driver AC protection (input side)	AP	Inverter outdoor fan driver AC input voltage error protection
Pc	Inverter compressor driver current detecting circuit error	AU	Inverter outdoor fan driver charging loop error
PF	Inverter compressor driver electric box temperature sensor error	A0	Inverter outdoor fan driver module reset
PH	High voltage protection for drive DC bus of inverter compressor	A1	Drive IPM module protection for inverter outdoor fan
PL	Inverter compressor driver DC bus low voltage protection or voltage drop error	A6	Master controller and inverter outdoor fan driver communication error
PP	Inverter compressor driver AC input voltage error protection	A8	Inverter outdoor fan driver module high-temperature protection
PU	Inverter compressor driver charging loop error	A9	Inverter outdoor fan driver module temperature sensor error

Error code	Error name	Error code	Error name
P0	Inverter compressor driver module reset	U9	Inverter outdoor fan driver AC input zero-sequence overcurrent protection
P5	Inverter compressor overcurrent protection	An	Inverter outdoor fan driver storage chip error
P6	Master controller and inverter compressor driver communication error	AF	Inverter outdoor fan driver PFC protection
P7	Inverter compressor driver module temperature sensor error	UL	Inverter outdoor fan overcurrent protection
P8	Inverter compressor driver module high-temperature protection	UP	Power protection for inverter fan
P9	Inverter compressor driver AC input zero-sequence overcurrent protection	—	—

## 2 TROUBLESHOOTING

### 2.1 E6-Communication Error

Possible cause:

- (1) Incorrect connection of the communication cord;
- (2) Wired controller (display board) error;
- (3) Main board error

Troubleshooting:

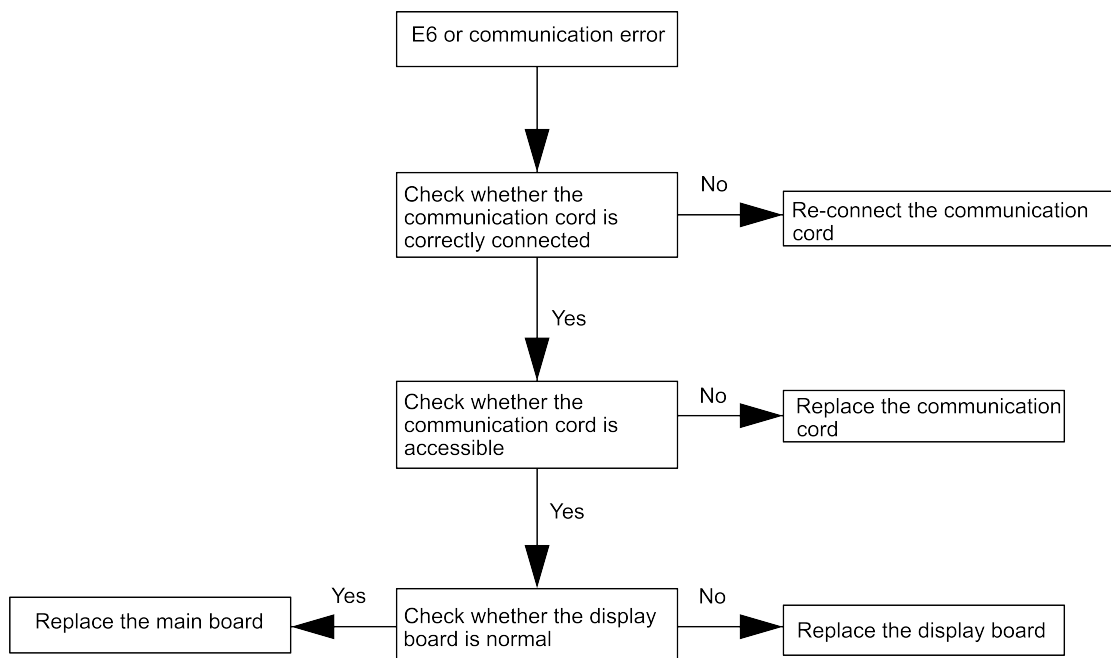

### 2.2 E1-High Pressure Protection

Possible cause:

- (1) Poor connection of the water tank temperature sensor;
- (2) Loose pressure switch cable;
- (3) Pressure switch error;
- (4) Drive board or main board error;
- (5) Abnormal heat exchange of the water tank.

## Troubleshooting:

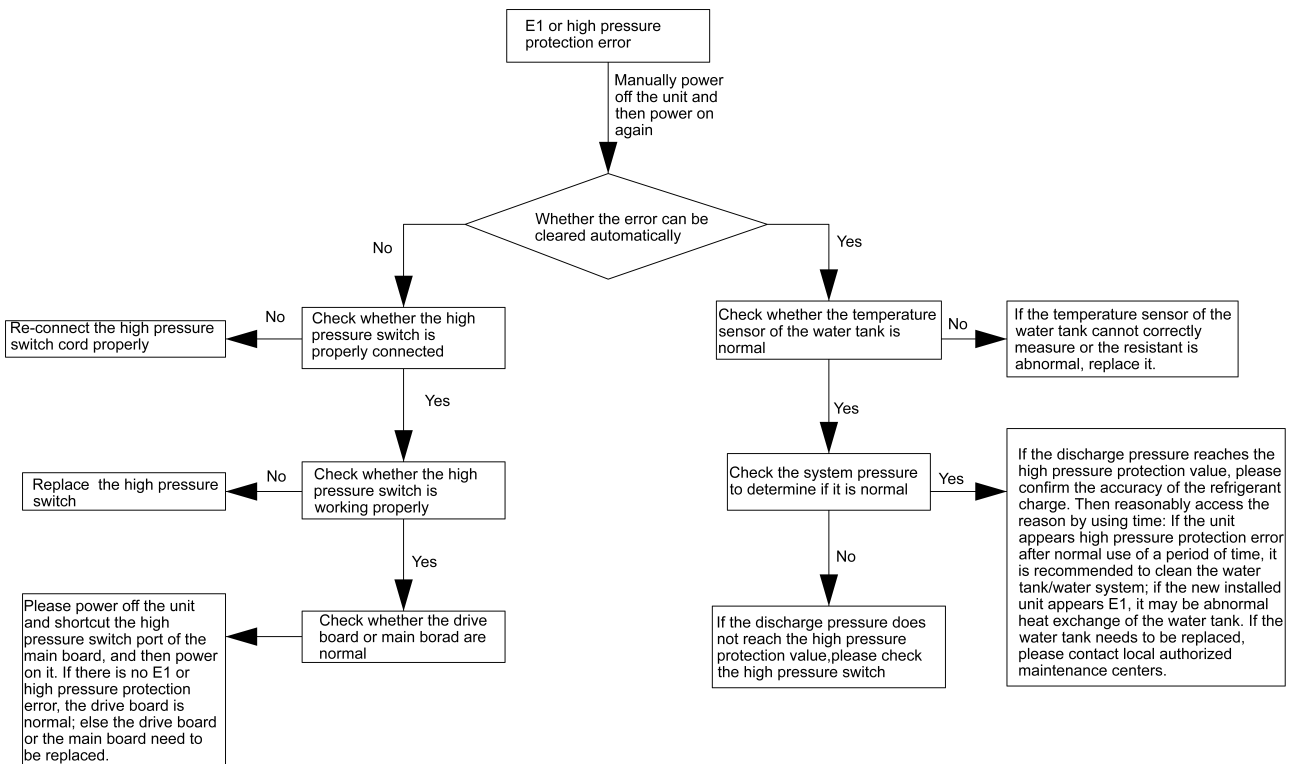

## 2.3 E3-Refrigerant-lacking Protection

Possible cause:

- (1) Refrigerant leakage of the unit;
- (2) Insufficient refrigerant of the unit

Troubleshooting:

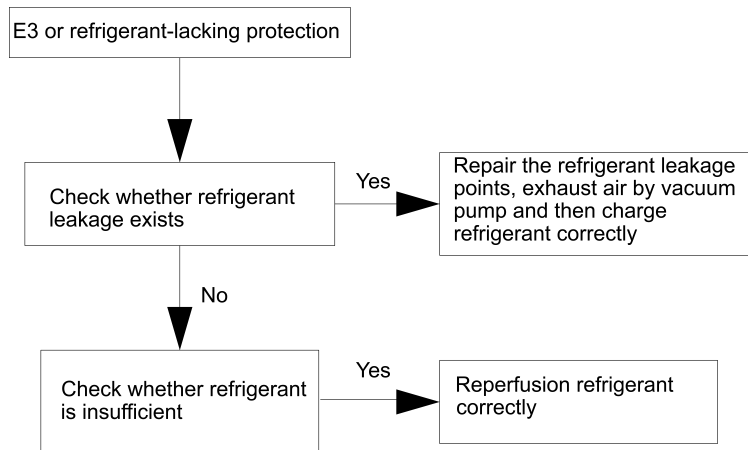

## 2.4 E4-High Discharge Temperature Protection

Possible cause:

- (1) Discharge Temperature Sensor Error;
- (2) Refrigerant leakage of the unit;
- (3) Insufficient refrigerant of the unit.

## Troubleshooting:

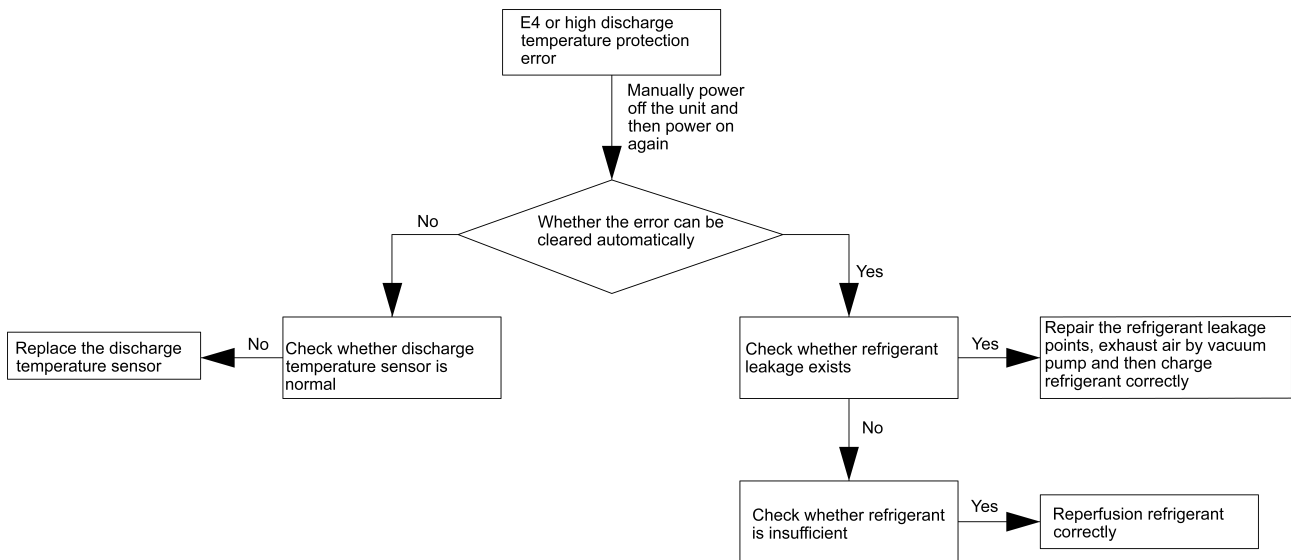

## 2.5 F3, F4, F6, Fd, FE, FL-Temperature Sensor Error

Possible cause:

- (1) Incorrect connection of temperature sensor;
- (2) Temperature sensor error;
- (3) Mainboard or drive board error.

Troubleshooting:

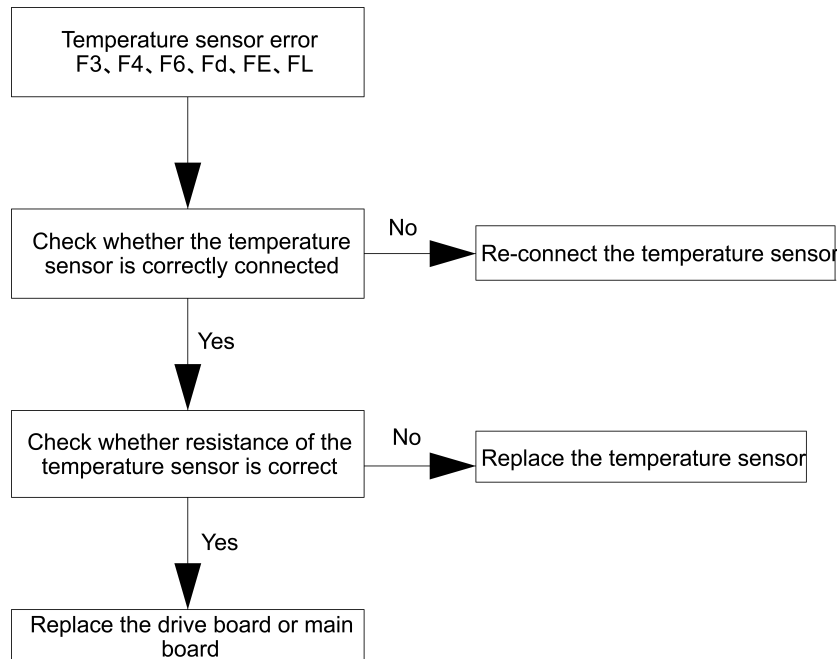

## 2.6 U7-Abnormal Reversing of 4-Way Valve

Possible cause:

- (1) The temperature sensors of the water tank are normal;
- (2) 4-way-valve is normal;
- (3) Refrigerant leakage of the unit;
- (4) Insufficient refrigerant of the unit.

## Troubleshooting:

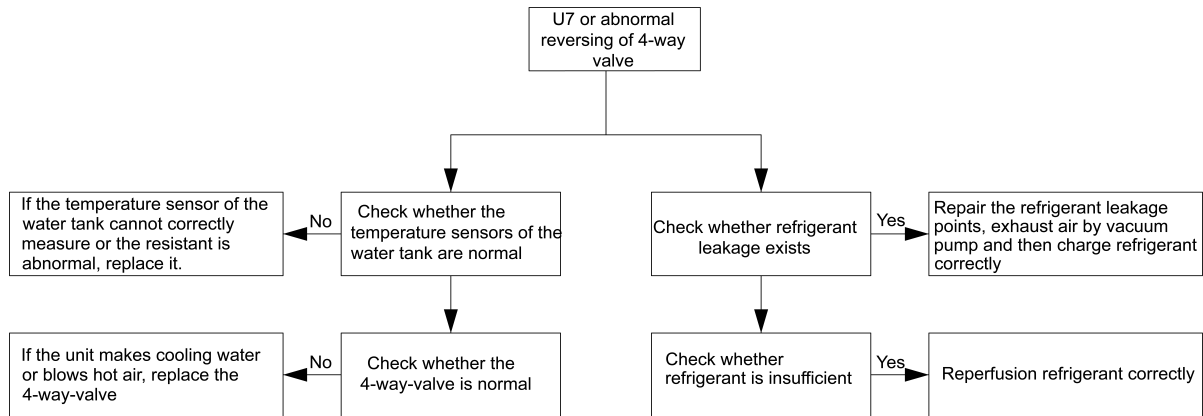

## 2.7 H5-Inverter Compressor Driver IPM Module Protection

## Possible cause:

- (1) Compressor 3-phase wire connection is lack of phase or phase-reversed;
- (2) System is overloaded and compressor current is too large;
- (3) Drive board IPM module is damaged;
- (4) Drive board IPM module's 15V power supply is lower than 13.5V;
- (5) Drive board 6-line PWM signal and the corresponding element are abnormal;
- (6) Drive board compressor current sampling circuit element is damaged or drive chip current sampling AD terminal is abnormal;
- (7) Compressor is damaged.

## Troubleshooting:

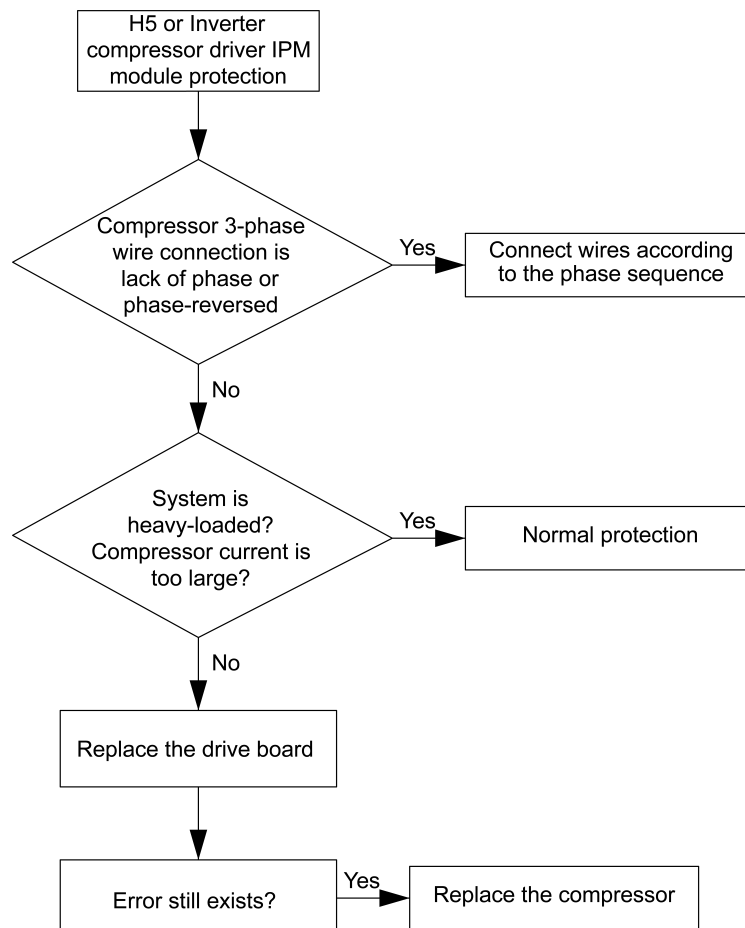

## 2.8 H7-Inverter Compressor Out-of-Step Protection

Possible cause:

- (1) Compressor 3-phase wire connection is lack of phase or phased-reversed;
- (2) Compressor phase wire connection is bad;
- (3) System is blocked, short of refrigerant or compressor oil;
- (4) Drive board IPM module is damaged;
- (5) Drive board compressor current sampling circuit element is damaged or drive chip current sampling AD terminal is abnormal;
- (6) Compressor is damaged.

Troubleshooting:

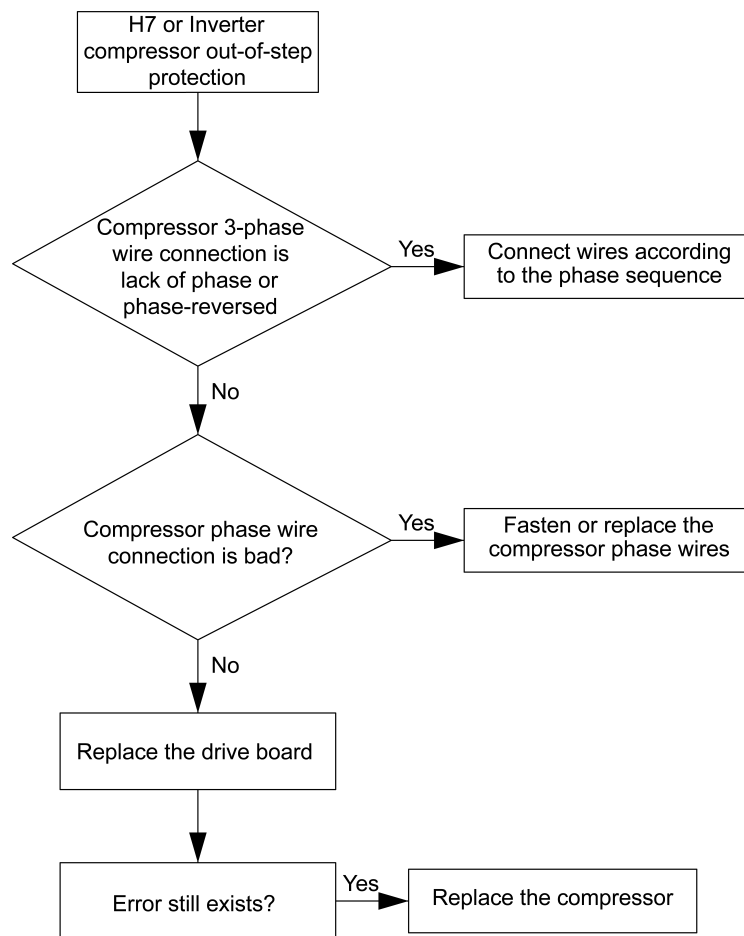

## 2.9 HC-Inverter Compressor Driver PFC Protection

Possible cause:

- (1) Power grid voltage is abnormal;
- (2) Drive board PFC module is damaged;
- (3) Drive board IPM module's 15V power supply is lower than 13.5V;
- (4) Drive board PWM signal for PFC and the corresponding element are abnormal;
- (5) Drive board PFC current sampling circuit element is damaged or drive chip current sampling AD terminal is abnormal.

Troubleshooting:

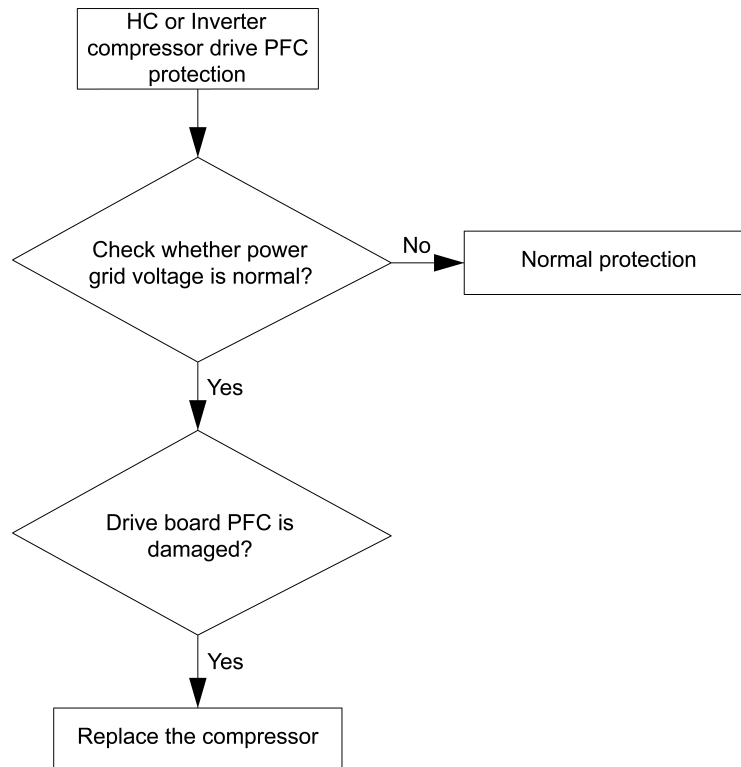

## 2.10 Lc-Inverter Compressor Startup Failure

Possible cause:

- (1) Poor contact of compressor UVW wire;
- (2) Compressor is broken;
- (3) Compressor drive board is broken.



## Troubleshooting:

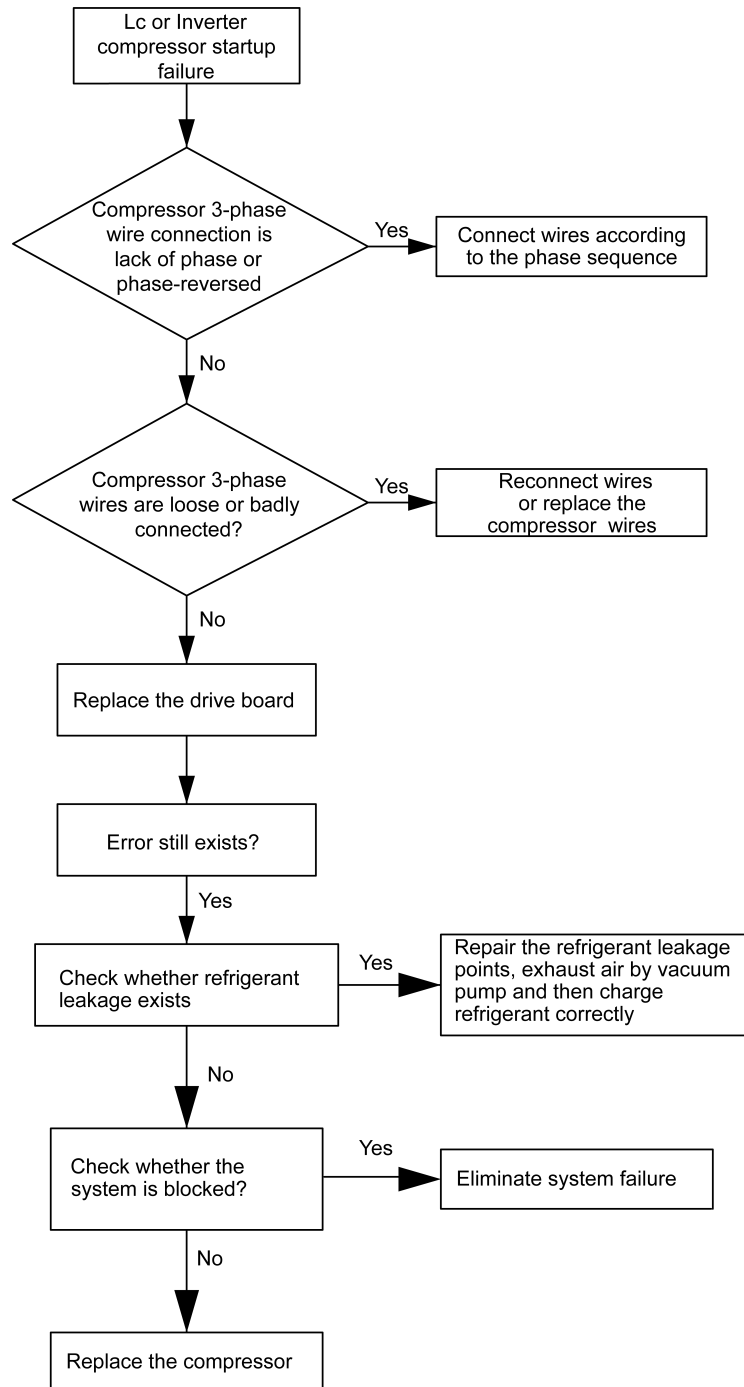

## 2.11 Ld-Inverter Compressor Default Phase Protection

Possible cause:

- (1) Compressor 3-phase wire connection is lack of phase or phase-reversed;
- (2) Drive board is damaged;
- (3) Compressor is damaged.

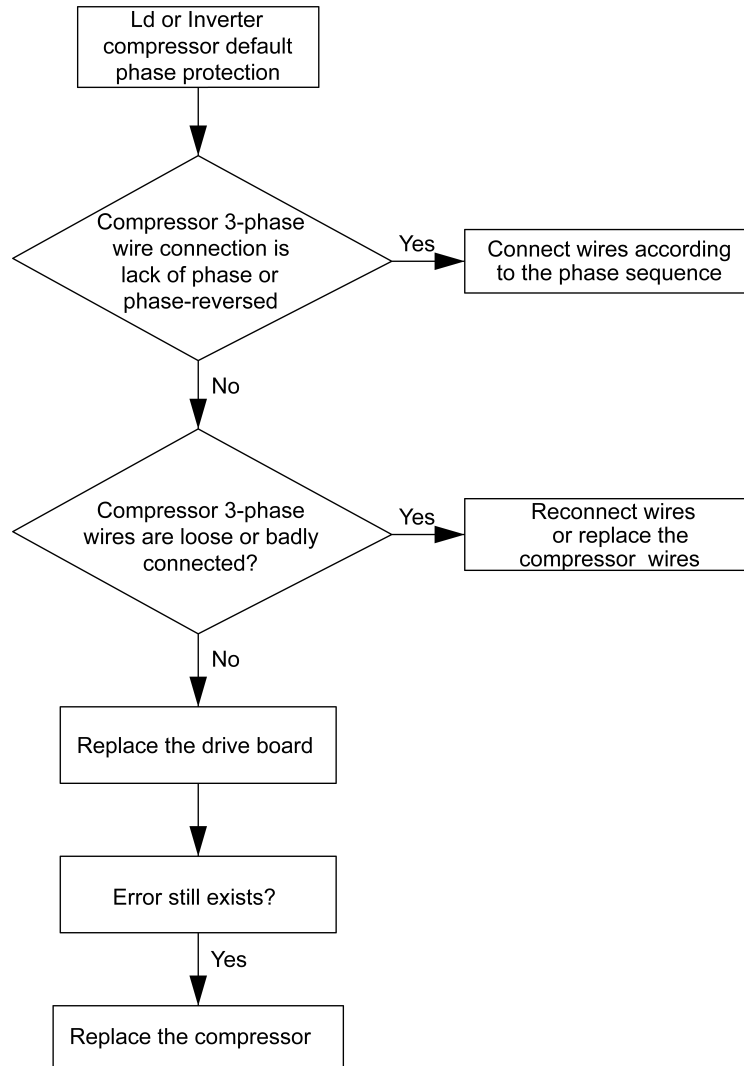

## 2.12 P0-Inverter Compressor Driver Module Reset

Possible cause:

- (1) 3.3V drive chip supply voltage drop;
- (2) TRST lead of JTAG programming is interrupted.

Troubleshooting:

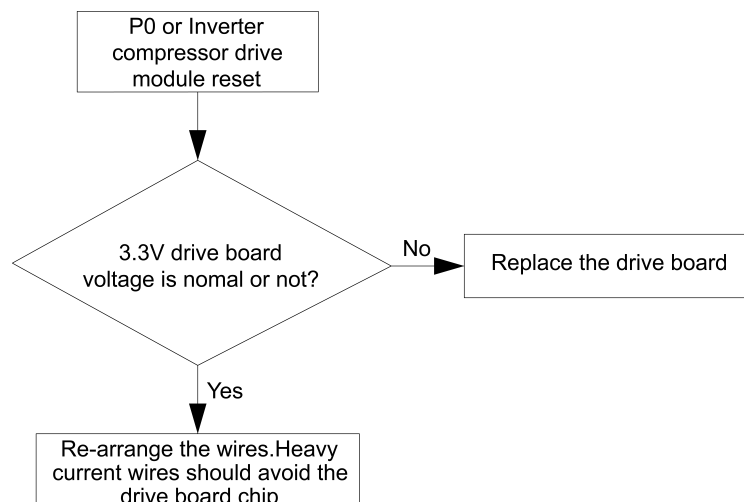

## 2.13 P5-Inverter Compressor Overcurrent Protection

Possible cause:

- (1) System load is too much and compressor current is too large;
- (2) Compressor phase wire is loose or has bad contact;
- (3) Drive board current sampling circuit element is damaged or drive chip current sampling AD terminal is abnormal;
- (4) Compressor is damaged.

Troubleshooting:

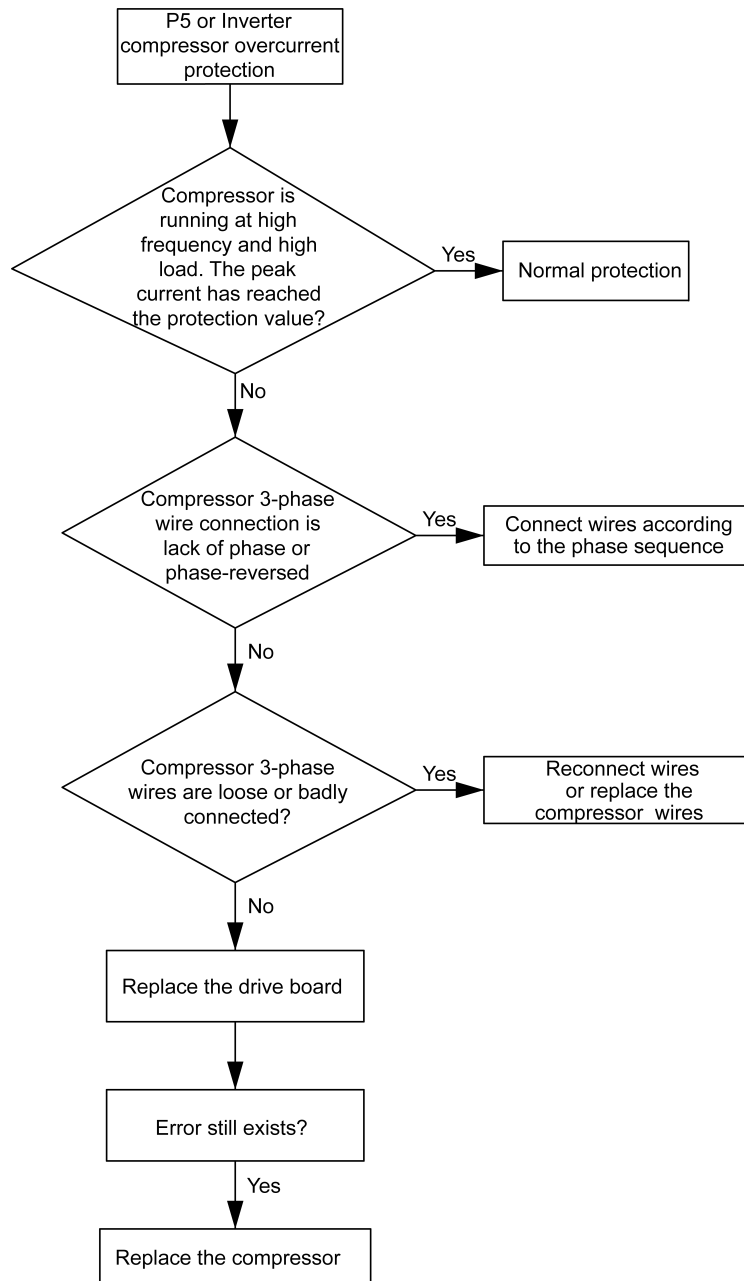

## 2.14 P6-Master Controller and Inverter Compressor Driver Communication Error

Possible cause:

- (1) Communication wire between master control and driver is not well connected, or has bad contact, or is broken;

- (2) The switch power of drive board is abnormal, therefore, the 3.3V power voltage is abnormal;
- (3) Communication circuit of the drive board or the master control board is abnormal.
- (4) Troubleshooting:

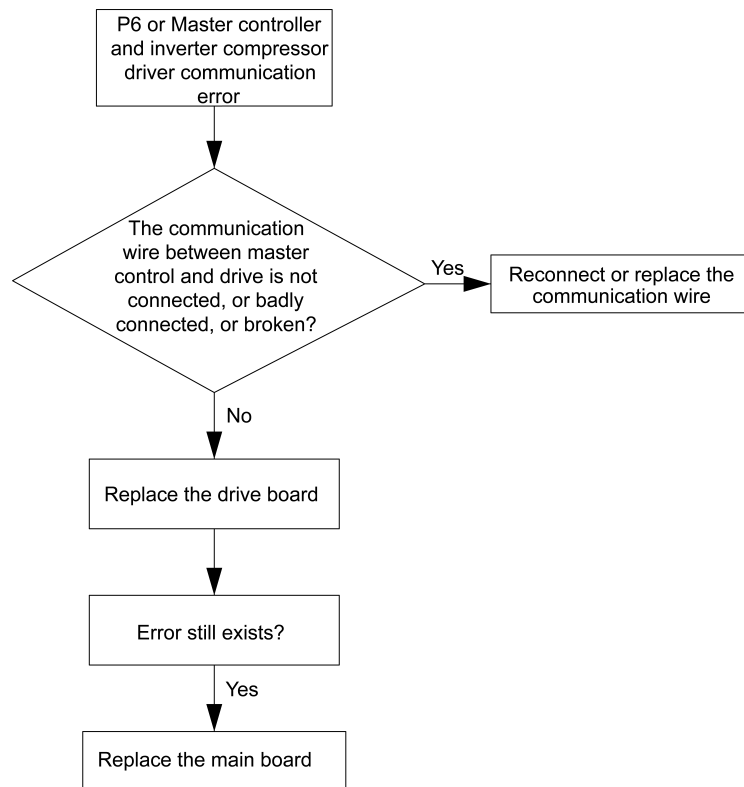

## 2.15 P7-Inverter Compressor Driver Module Temperature Sensor Error

Possible cause:

- (1) Module temperature sensor is short-circuited or broken-circuited;
- (2) Drive board current sampling circuit element is damaged or drive chip current sampling AD terminal is abnormal.

Troubleshooting :

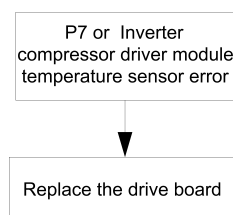

## 2.16 P8-Inverter Compressor Driver Module High-Temperature Protection

Possible cause:

- (1) Thermal grease is not applied or not evenly applied to the module, or there is other substance on the back of the module;
- (2) The module securing screws are not tightened up;
- (3) Drive board temperature sampling circuit element is damaged or drive chip temperature sampling AD terminal is abnormal.

Troubleshooting:

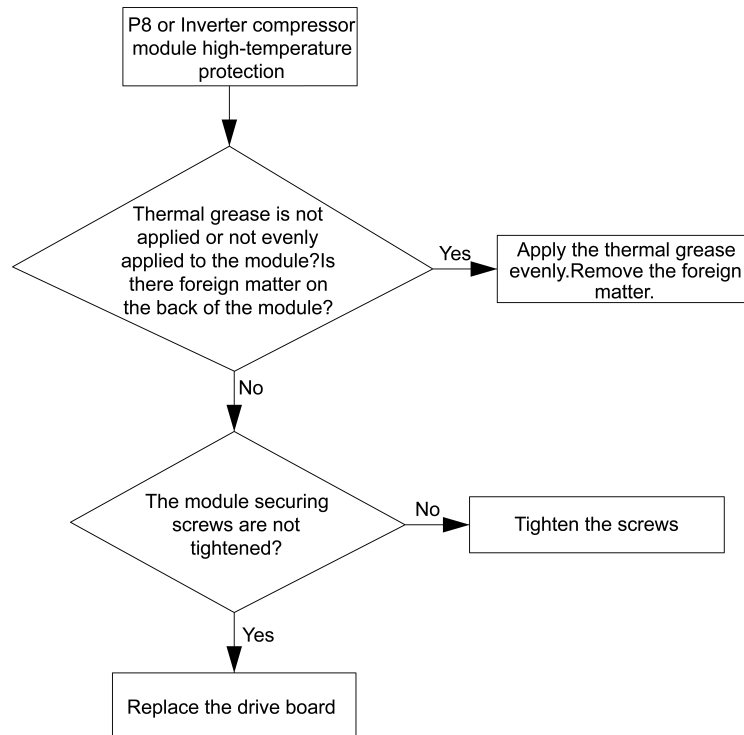

## 2.17 PA-Inverter Compressor Driver AC Protection (Input Side)

Possible cause:

- (1) System is heavy-loaded and compressor current is too large;
- (2) Grid voltage is abnormal;
- (3) PFC module is damaged;
- (4) Drive board PFC current sampling circuit element is damaged or drive chip PFC current sampling AD terminal is abnormal.

Troubleshooting:

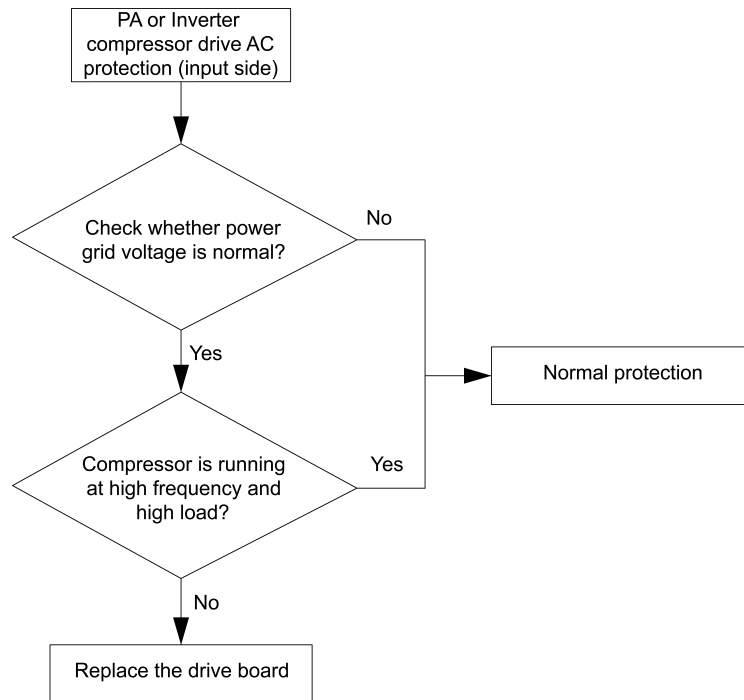

## 2.18 Pc-Inverter Compressor Driver Current Detecting Circuit Error

Possible cause:

- (1) Current detection (or current sensor) sampling circuit element is abnormal;
- (2) Drive chip compressor current sampling AD terminal is badly welded or short-circuited.

Troubleshooting:

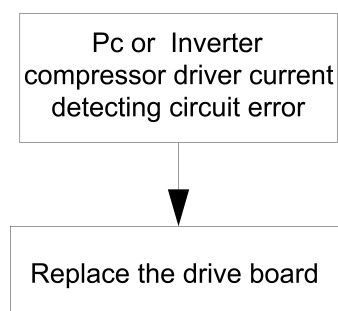

## 2.19 PL-Inverter Compressor Driver DC Bus Low Voltage Protection or Voltage Drop Error

Possible cause:

- (1) Voltage of power grid is abnormal;
- (2) Drive board busbar voltage sampling circuit element is damaged or drive board busbar voltage sampling AD terminal is abnormal.

Troubleshooting:

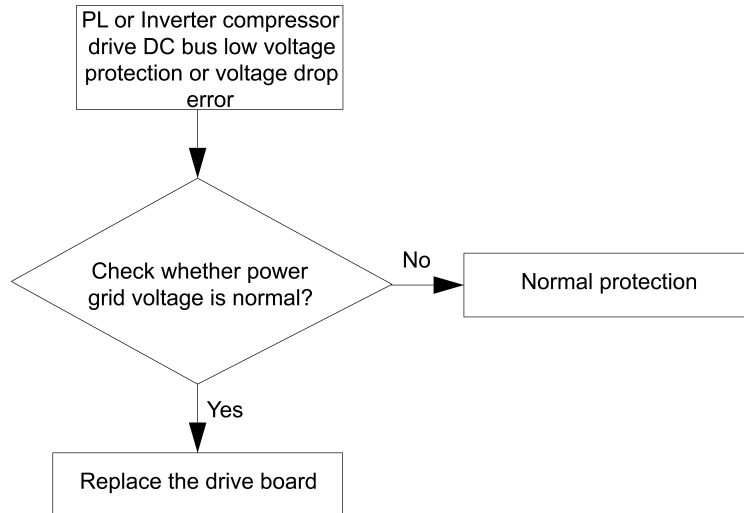

## 2.20 PH-High Voltage Protection for Drive DC Bus of Inverter Compressor

Possible cause:

- (1) Voltage of power grid is abnormal;
- (2) Drive board busbar voltage sampling circuit element is damaged or drive board busbar voltage sampling AD terminal is abnormal.

Troubleshooting:

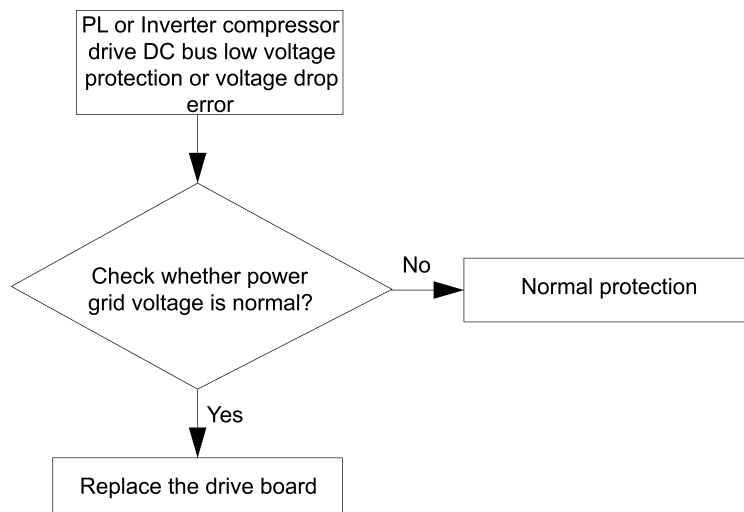

## 2.21 PU-Inverter Compressor Driver Charging Loop Error

Possible cause:

- (1) Voltage of power grid is abnormal. Voltage is too low;
- (2) Drive board charge loop element is abnormal;

- (3) Drive board busbar voltage sampling circuit element is damaged or drive chip busbar voltage sampling AD terminal is abnormal.

Troubleshooting:

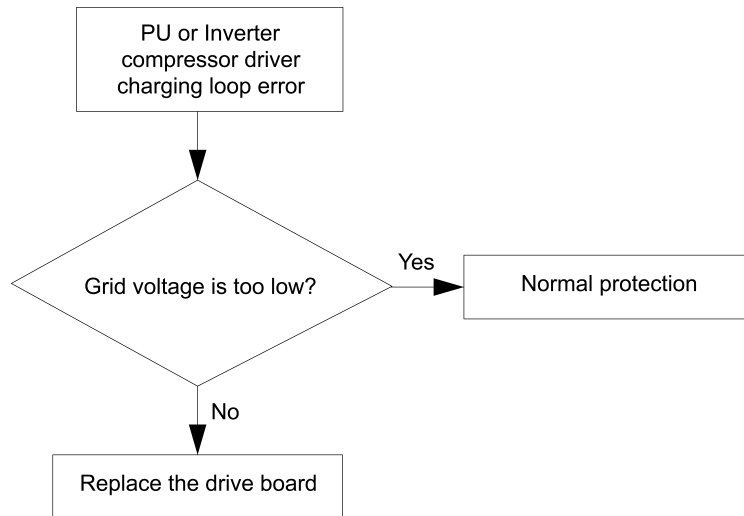

## 2.22 ee-Inverter Compressor Driver Storage Chip Error

Possible cause:

- (1) The drive board that needs memory chip is not installed with the memory chip;
- (2) The lead or connector of memory chip is badly welded or short-circuited.

Troubleshooting:

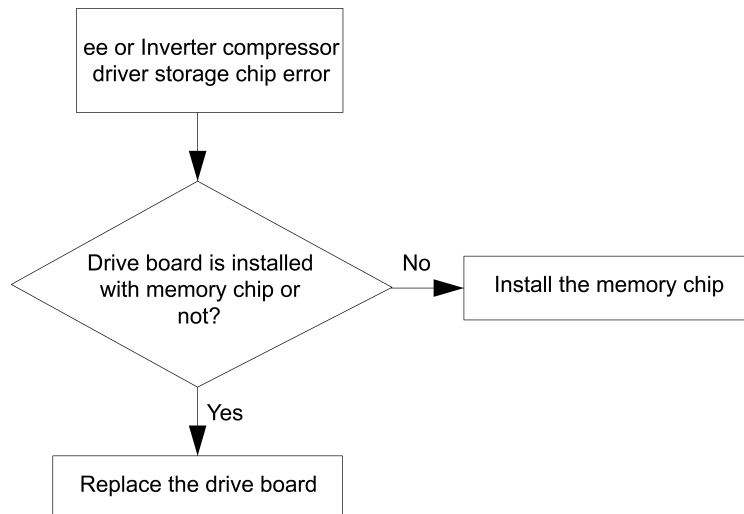



## 2.23 AC-Inverter Fan Startup Failure

Possible cause:

- (1) Poor contact of fan wires;
- (2) The fan blade is stuck by foreign matters or damage;
- (3) Drive board is broken.
- (4) The fan is broken.

Troubleshooting:

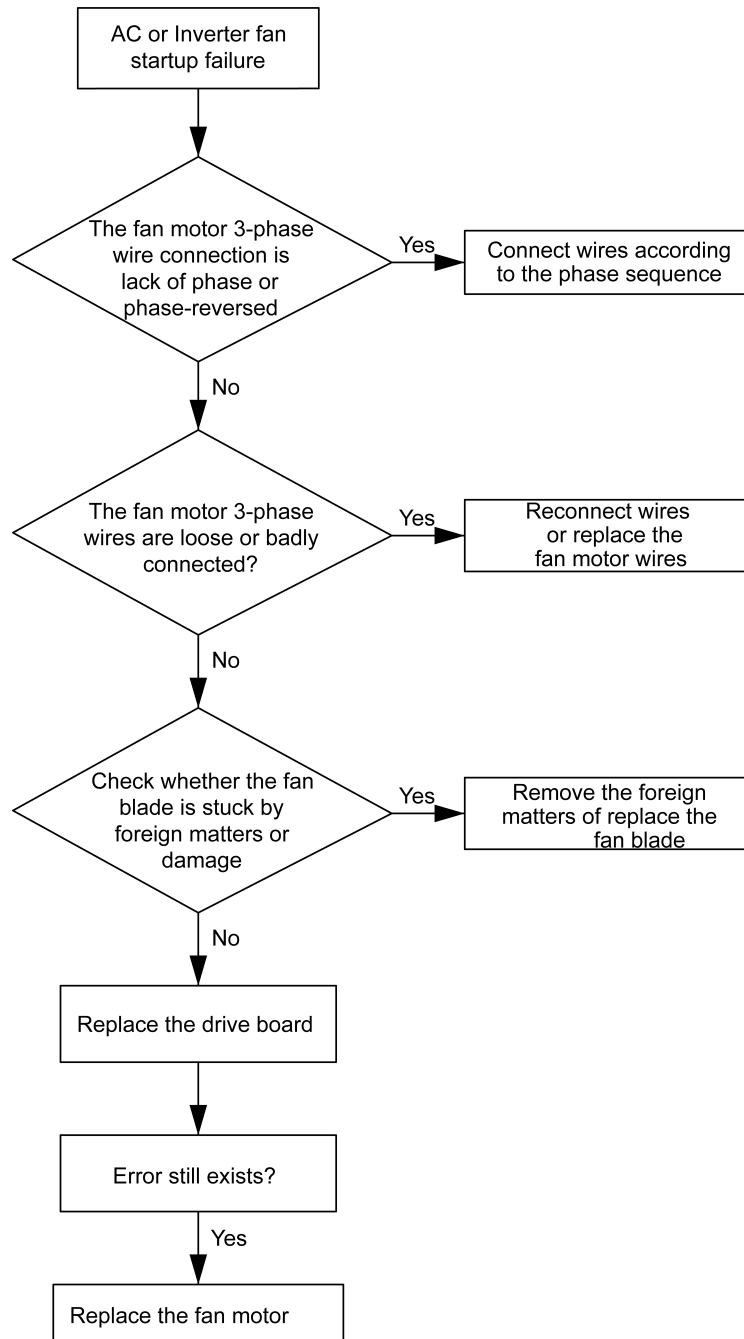

## 2.24 Ad-Inverter Fan Less Phase Protection

Possible cause:

- (1) The fan motor 3-phase wire connection is lack of phase or phase-reversed;
- (2) Drive board is damaged;

(3) The fan motor is damaged.

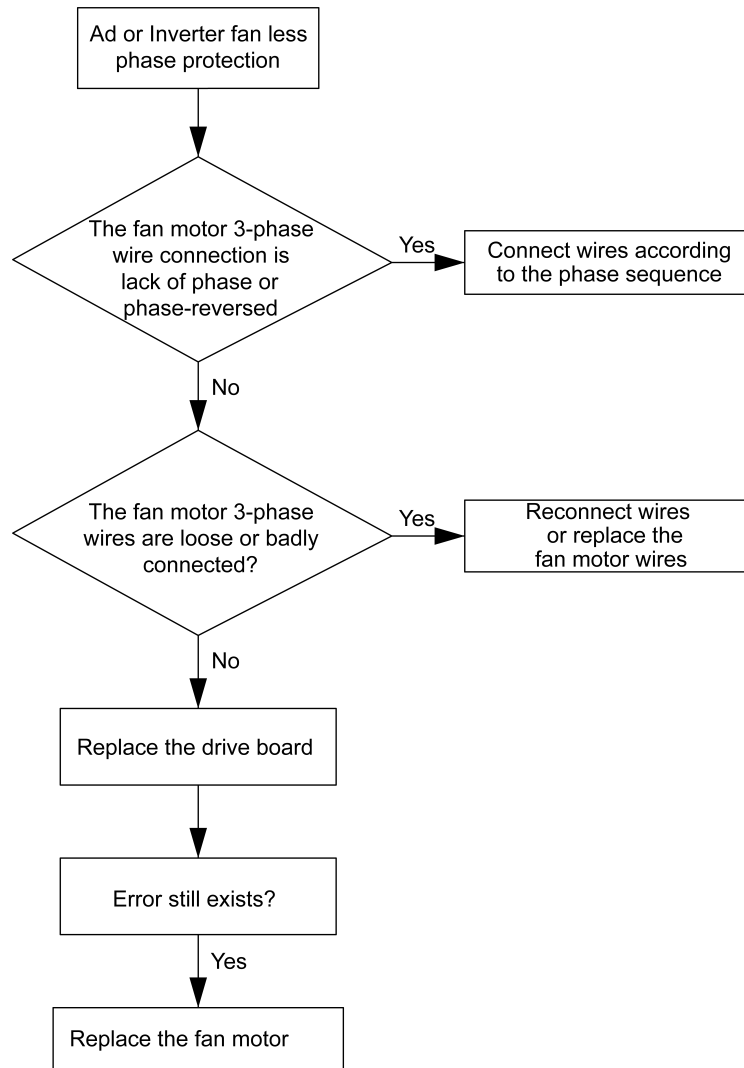

## 2.25 AE- Inverter Fan Driver Current Detecting Circuit Error

Possible cause:

(1) Drive board is damaged.

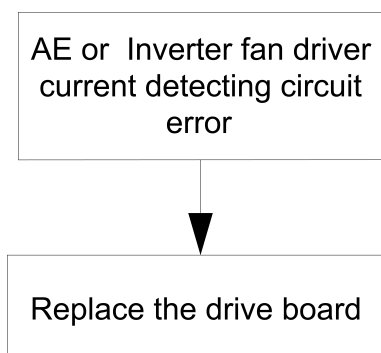

## 2.26 AL-Inverter Fan Driver DC Bus Low-Voltage Protection or Voltage Drop Error

Possible cause:

- (1) Voltage of power grid is abnormal;
- (2) Drive board is damaged.

Troubleshooting:

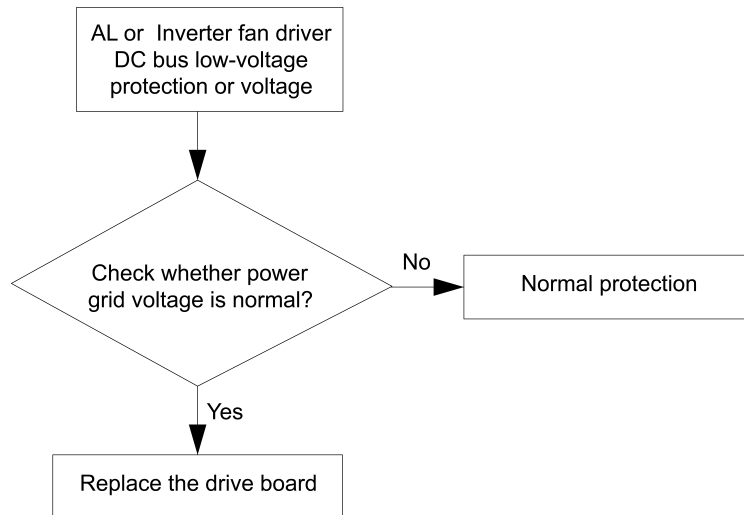

## 2.27 AJ-Inverter fan Out-of-Step Protection

Possible cause:

- (1) The fan motor 3-phase wire connection is lack of phase or phased-reversed;
- (2) The fan motor phase wire connection is bad;
- (3) The fan motor is damaged.

Troubleshooting:

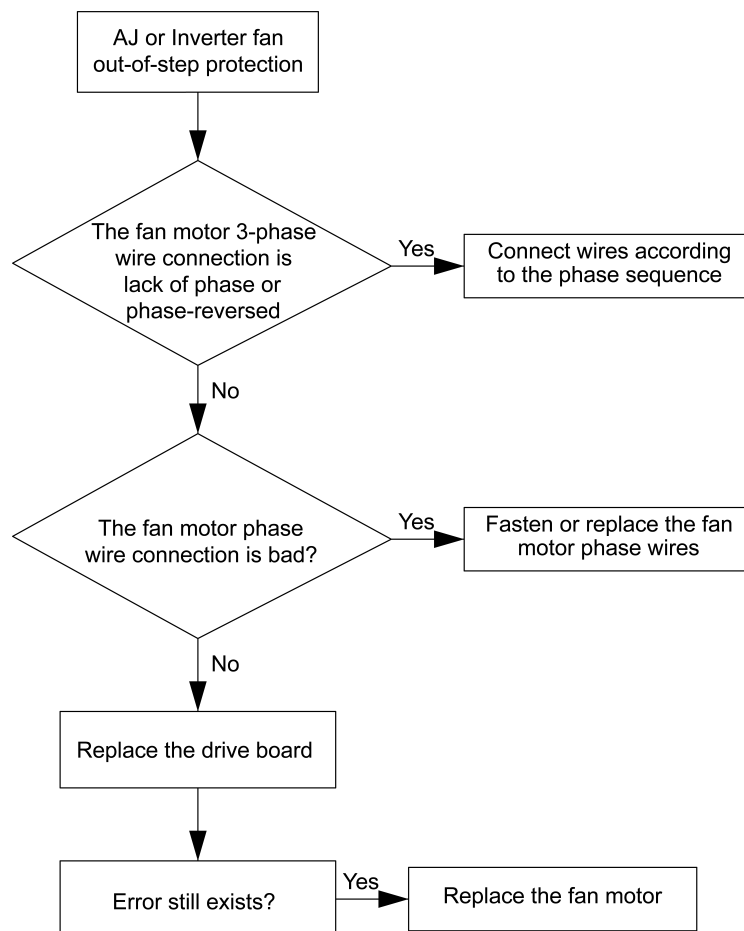

## 2.28 AH-Inverter Fan Driver DC Bus High-Voltage Protection

Possible cause:

- (1) Voltage of power grid is abnormal;

(2) The drive board is damaged.

Troubleshooting:

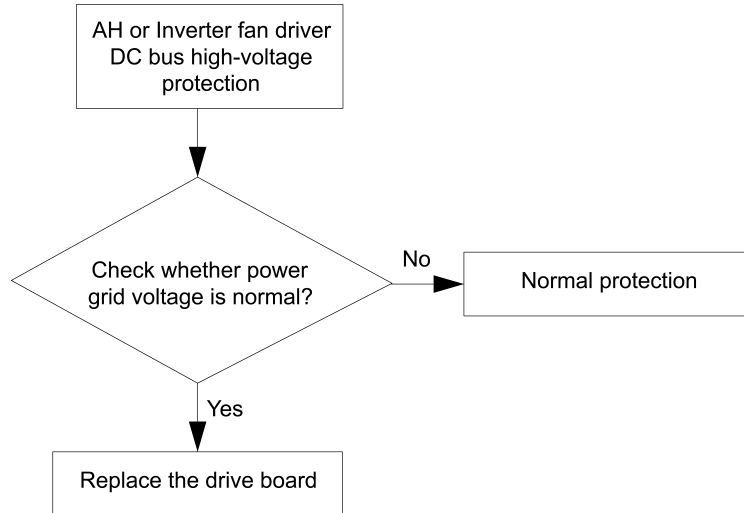

## 2.29 A1-Drive IPM Module Protection for Inverter Fan

Possible cause:

- (1) The fan motor 3-phase wire connection is lack of phase or phase-reversed;
- (2) System is overloaded and the fan motor current is too large;
- (3) Drive board IPM module is damaged;
- (4) The fan motor is damaged.

Troubleshooting:

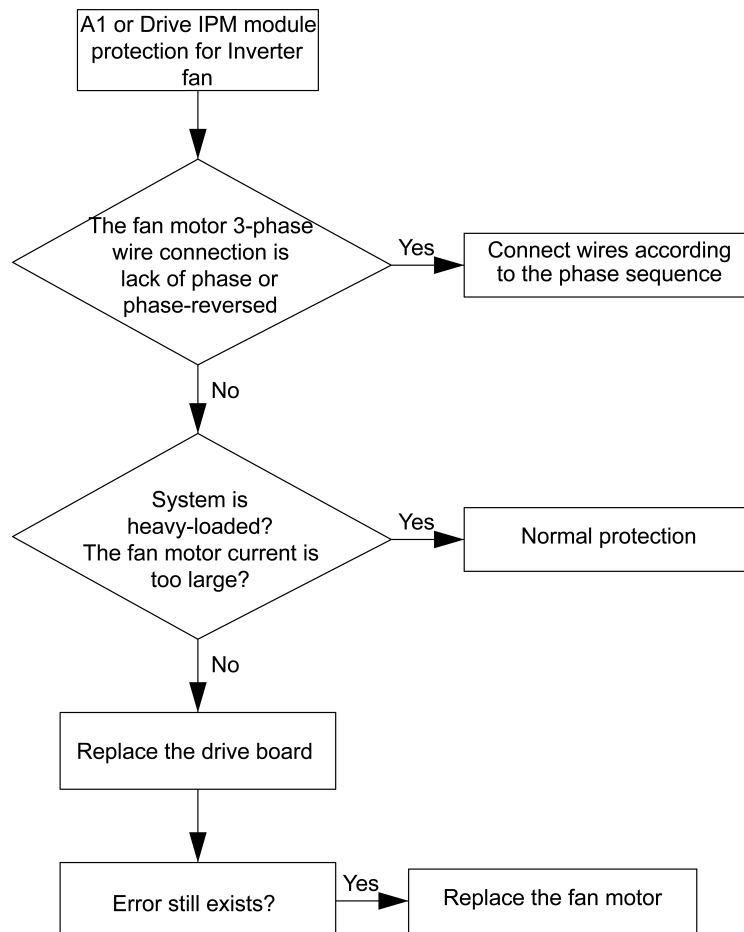

## 2.30 A6-Master Controller and Inverter Fan Driver Communication Error

Possible cause:

- (1) Communication wire between master control and driver is not well connected, or has bad contact, or is broken;
- (2) The switch power of drive board is abnormal;
- (3) Communication circuit of the drive board or the master control board is abnormal.

Troubleshooting:

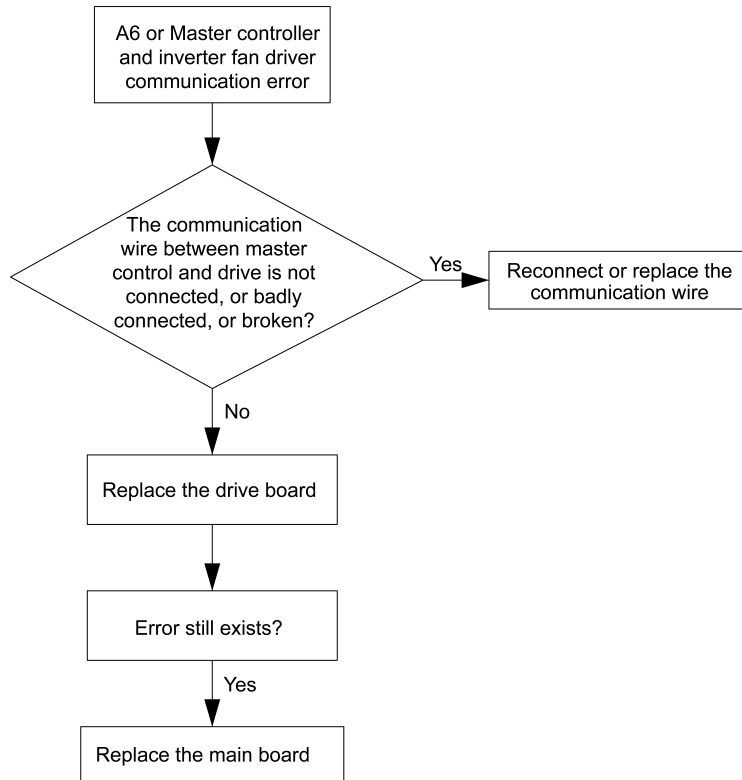

## 2.31 UL-Inverter Fan Overcurrent Protection

Possible cause:

- (1) System load is too much and the fan current is too large;
- (2) The fan motor phase wire is loose or has bad contact;
- (3) Drive board is damaged;
- (4) The fan motor is damaged.

Troubleshooting:

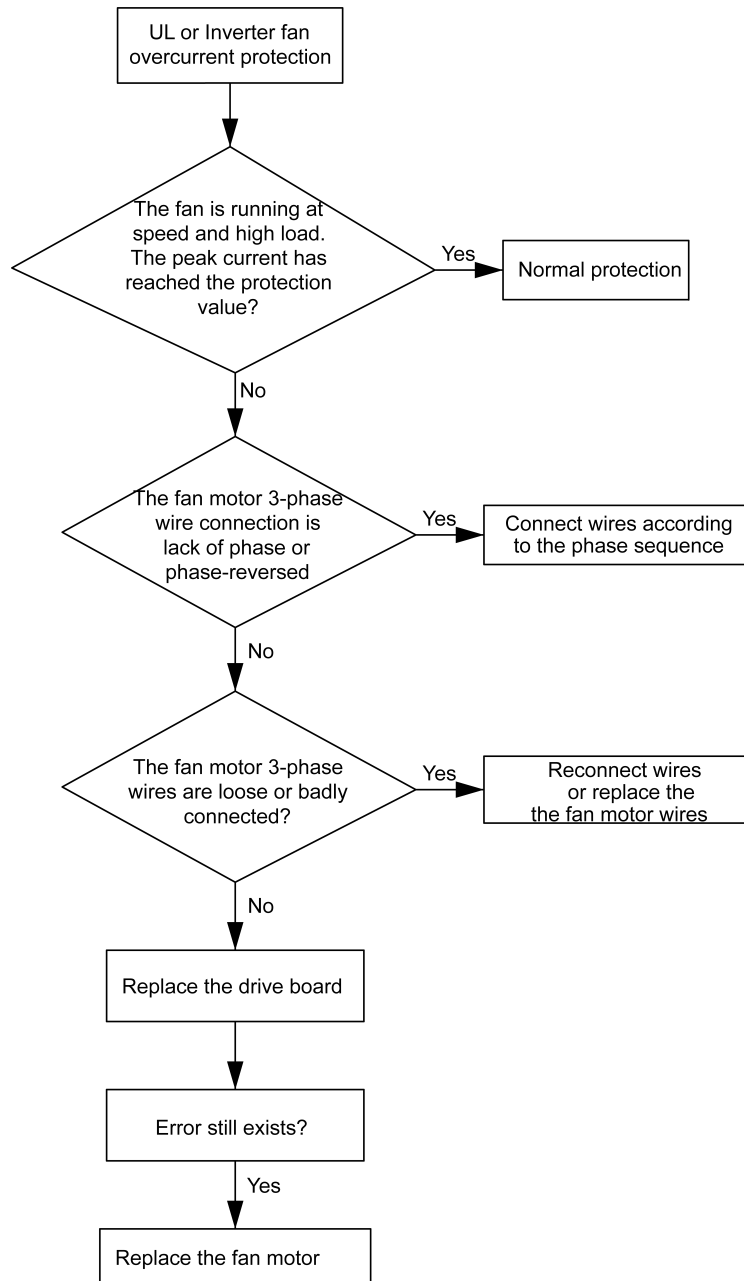

## 3 REPAIR OF KEY COMPONENTS

### 3.1 Introduction of Parts

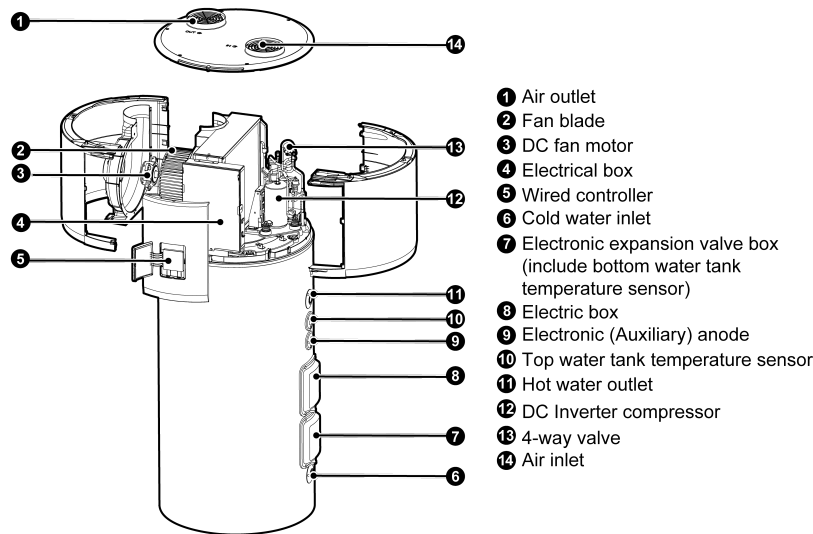

### 3.2 Introduction of Key Components

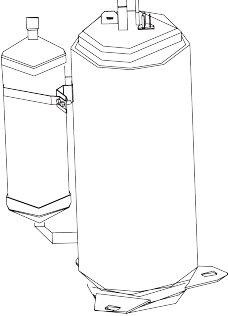
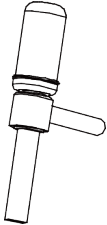
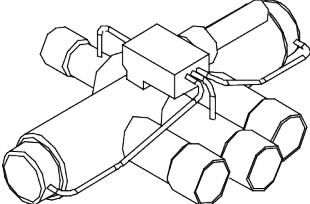
 <p>Compressor</p>	<ul style="list-style-type: none"> <li>• Driven by the electric energy, the compressor compresses refrigerant to high-temperature and high-pressure gas and enables the gas to flow circularly in the refrigerant.</li> <li>• Volume of the low-pressure refrigerant decreases via compression. After the pressure and temperature increases gradually, it becomes high-pressure and high-temperature refrigerant, which is the driving force of the entire system.</li> </ul>
 <p>Electronic expansion valve</p>	<ul style="list-style-type: none"> <li>• The electronic expansion valve performs throttling and pressure reduction to high-pressure liquid refrigerant to ensure the pressure difference between the condenser and evaporator.</li> <li>• In addition, it adjusts the flow rate of refrigerant entering the evaporator based on heat load change of the evaporator so as to ensure stable operation of the refrigeration equipment.</li> </ul>
 <p>4-way valve</p>	<ul style="list-style-type: none"> <li>• The 4-way valve changes flow direction of refrigerant during defrosting of the circular water heater. In the defrosting mode, the compressed refrigerant enters the evaporator for heat exchange and defrosting after its flow direction is changed by the 4-way valve. Then it flows into the tube heat changer through the expansion valve. After that, it is sucked by the compressor to enter the next cycle.</li> </ul>

### 3.3 Disassembly of Key Components



**WARNING!**

Before removing the main unit, please make sure that the unit is disconnected with the power.

### 3.3.1 Disassembly of Main Unit

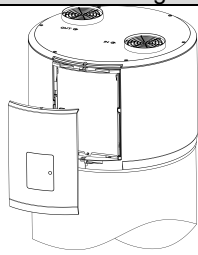
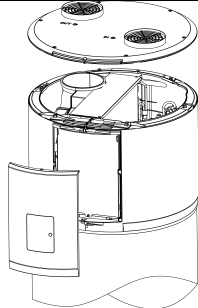
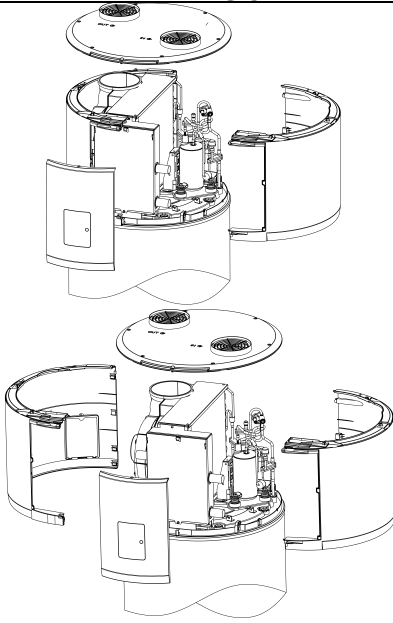
Disassembly of main unit		
Process	Schematic Diagram	Operation Instruction
1. Disconnect power supply and then remove the face cover of the main unit		<ul style="list-style-type: none"> <li>● Twist off the screws in the top cover used for fixing the face cover and then remove it.</li> </ul>
2. Remove top cover		<ul style="list-style-type: none"> <li>● Loose the screws fixing the top cover with screwdriver;</li> <li>● Hold the top cover upwards and then put it on the floor flatly.</li> </ul>
3. Remove the right side and left side cover		<ul style="list-style-type: none"> <li>● Loose the screw fixing the left and right side cover with screwdriver;</li> <li>● Hold the covers upwards and then put it on the floor flatly.</li> </ul>



### 3.3.2 Disassembly & Assembly of Key Components of Unit

#### (1) Disassembly & Assembly of Compressor

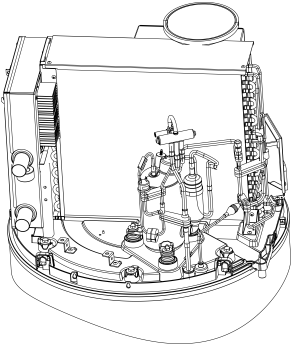
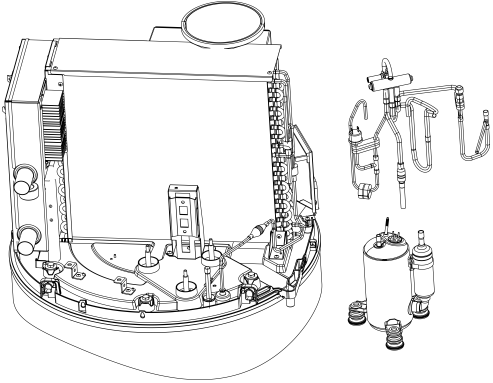
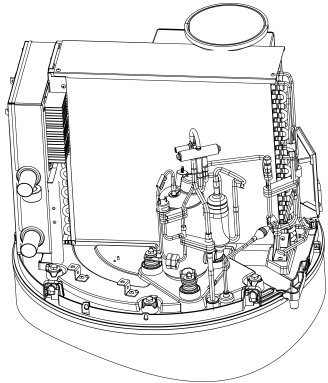
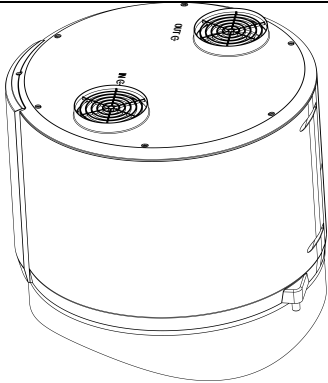
Disassembly and Assembly of Compressor		
Step	Schematic Diagram	Operation instructions
1. Remove power cord of compressor		<ul style="list-style-type: none"> <li>●Disconnect power supply;</li> <li>●Remove the compressor wires from the drive board.</li> </ul> <p>Note: when removing compressor lines, make marks on them to avoid confusion.</p>
2. Remove the fixing bolt of compressor		<ul style="list-style-type: none"> <li>●Loosen the fixing bolt of compressor; remove the compressor foot cushion if there is any.</li> </ul>
3. Remove suction pipe and discharge pipe of compressor		<ul style="list-style-type: none"> <li>●Heat the suction pipe and discharge pipe of compressor with fired heater, and then remove them;</li> <li>●Charge nitrogen for protection during welding; nitrogen pressure is <math>0.5 \pm 0.1 \text{ kgf/cm}^2</math> (relative pressure).</li> </ul> <p>Note: pay attention not to burn the surrounding materials during heating.</p>
4. Remove compressor		<ul style="list-style-type: none"> <li>●Remove the fixing bolts of compressor's feet;</li> <li>●Remove the compressor from fixing shelf.</li> </ul> <p>Note: remove the compressor horizontally and uprightly.</p>
5. Assemble compressor		<ul style="list-style-type: none"> <li>●Assemble the repaired compressor or new compressor on the fixing shelf;</li> <li>●Screw up the fixing bolts of compressor's feet.</li> </ul> <p>Note: assemble the compressor horizontally and uprightly.</p>
6. Assemble fixing bolt of compressor		<ul style="list-style-type: none"> <li>●Screw up the fixing bolt of compressor</li> </ul>
7. Assemble suction pipe and discharge pipe of compressor		<ul style="list-style-type: none"> <li>●Heat the suction pipe and discharge pipe of compressor with fired heater, and then weld them with the system;</li> <li>●Charge nitrogen for protection during welding; nitrogen pressure is <math>0.5 \pm 0.1 \text{ kgf/cm}^2</math> (relative pressure).</li> </ul> <p>Note: pay attention not to burn the surrounding materials during heating.</p>
8. Assemble the compressor wires		<ul style="list-style-type: none"> <li>●Assemble the compressor wires according to the opposite step of disassembling it;</li> <li>●Connecting the compressor wires to the drive board</li> </ul>
9. Check and reinstall		<ul style="list-style-type: none"> <li>●Check whether the pipeline is connected well;</li> <li>●Check whether all parts and connection wires are connected well;</li> <li>●If there's no problem after checking, install left side, right side, top side and face cover.</li> </ul>
<p><b>Note: make sure there is no refrigerant in the pipeline and power supply is cut off before removing the compressor.</b></p>		

## (2) Disassembly &amp; Assembly of 4-Way Valve

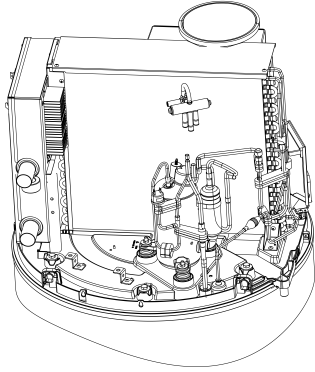
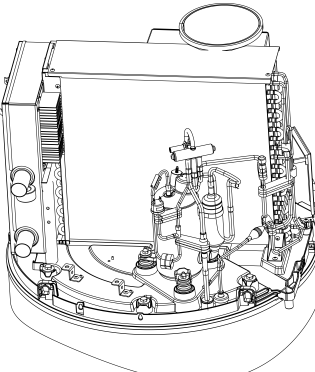
Disassembly and Assembly of 4-Way Valve		
Step	Schematic Diagram	Operation instructions
1. Unsolder 4-way valve		<ul style="list-style-type: none"> <li>●Mark the direction of 4-way valve before unsoldering;</li> <li>●Remove the coil and mark its direction;</li> <li>●Wrap the 4-way valve with a wet cloth during soldering to avoid damage to the valve or water getting into the pipeline;</li> <li>●Charge nitrogen for protection during welding; nitrogen pressure is <math>0.5 \pm 0.1 \text{ kgf/cm}^2</math> (relative pressure).</li> </ul>
2. Remove 4-way valve		<ul style="list-style-type: none"> <li>●Remove the 4-way valve carefully to avoid touching other parts or pipeline.</li> </ul>
3. Assemble 4-way valve		<ul style="list-style-type: none"> <li>●Assemble the 4-way valve carefully at the previous position; avoid touching other parts or pipeline.</li> </ul>
4. Welding the 4-way valve		<ul style="list-style-type: none"> <li>●The new 4-way valve should be in the same model as the old one;</li> <li>●Pipeline connection should be the same as before;</li> <li>●Charge nitrogen for protection during welding; nitrogen pressure is <math>0.5 \pm 0.1 \text{ kgf/cm}^2</math> (relative pressure).</li> </ul>

## (3) Disassembly &amp; Assembly of High Pressure Switch

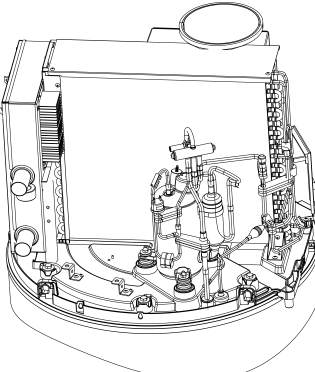
Disassembly and Assembly of High Pressure Switch		
Step	Schematic Diagram	Operation instructions
1. Unplug the pressure switch wire from the drive board of the unit		Refer to the unit wiring diagram.
2. Cut the high temperature wire tie of all fixed pressure switch wires.		Avoid breaking other wires.
3. Remove the pressure switch.		Remove the pressure switch carefully to avoid touching other parts or pipeline.
4. Welding the pressure switch		<ul style="list-style-type: none"> <li>●The new pressure switch should be in the same model as the old one;</li> <li>●Pipeline connection should be the same as before;</li> <li>●Charge nitrogen for protection during welding; nitrogen pressure is <math>0.5 \pm 0.1 \text{ kgf/cm}^2</math> (relative pressure).</li> <li>●Replace all the high-temperature wires, tie them up and restore the wiring of the unit.</li> <li>●Assemble the unit in the converse sequence.</li> </ul>

## (4) Disassembly &amp; Assembly of Blade and Motor

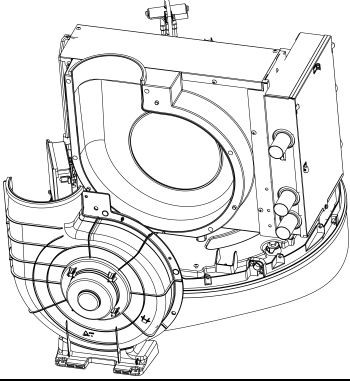
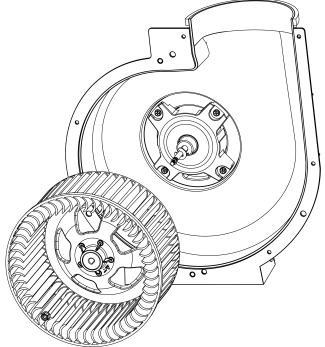
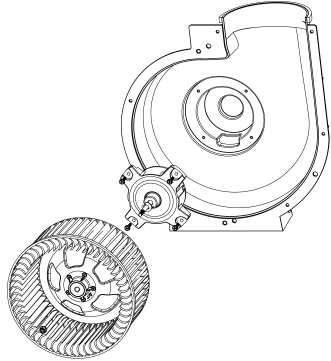
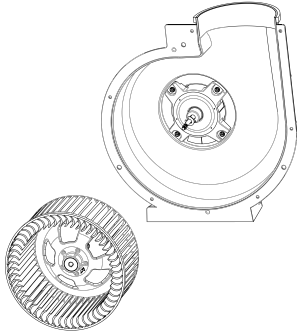
Disassembly and Assembly of Blade and Motor		
Remark: Before removing the motor, please make sure that the unit is disconnected with the power.		
Process	Schematic Diagram	Operation Instruction
1. Remove the retaining screws of the volute		<ul style="list-style-type: none"> <li>• Loose screws fixing the volute.</li> </ul>
2. Remove blade		<ul style="list-style-type: none"> <li>• Loosen nuts fixing the blade with wrench;</li> <li>• Then remove the blade.</li> </ul>
3. Remove motor		<ul style="list-style-type: none"> <li>• Loose screws fixing the motor with screwdriver;</li> <li>• then remove the power cord of motor;</li> <li>• Take out the damaged motor.</li> </ul>
4. Install motor		<ul style="list-style-type: none"> <li>• Replace the motor, tighten screws with screwdriver and then connect the power cord of motor.</li> </ul>

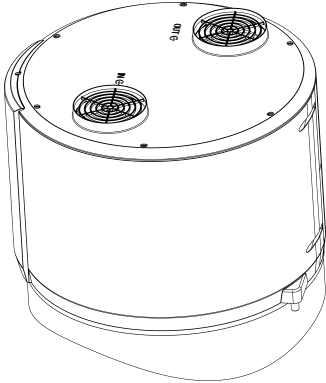
Disassembly and Assembly of Blade and Motor		
Remark: Before removing the motor, please make sure that the unit is disconnected with the power.		
Process	Schematic Diagram	Operation Instruction
5.Assemble unit		<ul style="list-style-type: none"> <li>Assemble the unit in the converse sequence.</li> </ul>

### 3.3.3 Disassembly of Key Components of the Water Tank

- (1) Procedure for replacing the water temperature sensor
  - 1) Remove the water temperature sensor cover.
  - 2) Take out the insulation sponge of the temperature sensor.
  - 3) Remove the fixed nut of the temperature sensor.
  - 4) Take out the temperature sensor and the fixed clamp.
  - 5) Then replacing the same temperature sensor.
  - 6) Install all parts of the temperature sensor in order, and then tidy up the temperature sensor line.
- (2) Procedure for replacing the electronic anode
  - 1) Before removing the electronic anode, drain the water tank by following drainage operations.
  - 2) Open the cap on the mounting mouth for the electronic anode.
  - 3) Use a hex key to unscrew the electronic anode, and then steadily removed the electronic anode to prevent it from falling.
  - 4) Install a new electronic anode into the mounting mouth, and then tighten it using a hex key.
  - 5) Close the cap, and replenish water by following water replenishment operations.

### 3.4 Thermostat Reset Operation

When the thermostat of electrical heater is disconnected, the reset button will be popped up. You need to remove the electrical box cover, and press the reset button and reset the thermostat.

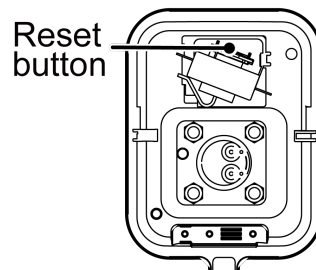

Figure 3.4-1 Thermostat reset button diagram

## 3.5 Detailed Maintenance Instructions for Refrigeration System

### 3.5.1 Safety Notices for Refrigeration System Repairation



- Appliance filled with flammable gas R290. Before repair the appliance, read the service manual first and in strict accordance with the requirement of manufacturer.
- This chapter mainly focuses on the special maintenance requirements of appliances using R290 refrigerant. For detailed maintenance operations, refer to the after-sales technical service manual.

### 3.5.2 Aptitude Requirement for Maintenance Man (Repairs should be done only be specialists).

- (1) Any person who is involved with working on or breaking into a refrigerant circuit should hold a current valid certificate from an industry-accredited assessment authority, which authorises their competence to handle refrigerants safely in accordance with an industry recognised assessment specification.
- (2) Servicing shall only be performed as recommended by the equipment manufacturer. Maintenance and repair requiring the assistance of other skilled personnel shall be carried out under the supervision of the person competent in the use of flammable refrigerants.

### 3.5.3 Safety Preparation Work

Prior to beginning work on systems containing flammable refrigerants, safety checks are necessary to ensure that the risk of ignition is minimised. For repair to the refrigerating system, the following precautions shall be complied with prior to conducting work on the system.

#### 3.5.3.1 Work Procedure

Work shall be undertaken under a controlled procedure so as to minimise the risk of a flammable gas or vapour being present while the work is being performed.

#### 3.5.3.2 General Work area

All maintenance staff and others working in the local area shall be instructed on the nature of work being carried out. Work in confined spaces shall be avoided. The area around the workspace shall be sectioned off. Ensure that the conditions within the area have been made safe by control of flammable material

#### 3.5.3.3 Checking for Presence of Refrigerant

The area shall be checked with an appropriate refrigerant detector prior to and during work, to ensure the technician is aware of potentially toxic or flammable atmospheres. Ensure that the leak detection equipment being used is suitable for use with all applicable refrigerants, i.e. non-sparking, adequately sealed or intrinsically safe.

#### 3.5.3.4 Presence of Fire Extinguisher

If any hot work is to be conducted on the refrigeration equipment or any associated parts, appropriate fire extinguishing equipment shall be available to hand. Have a dry powder or CO<sub>2</sub> fire extinguisher adjacent to the charging area.

### 3.5.3.5 No Ignition Sources

No person carrying out work in relation to a refrigeration system which involves exposing any pipe work shall use any sources of ignition in such a manner that it may lead to the risk of fire or explosion. All possible ignition sources, including cigarette smoking, should be kept sufficiently far away from the site of installation, repairing, removing and disposal, during which refrigerant can possibly be released to the surrounding space. Prior to work taking place, the area around the equipment is to be surveyed to make sure that there are no flammable hazards or ignition risks. "No Smoking" signs shall be displayed.

### 3.5.3.6 Ventilated Area

Ensure that the area is in the open or that it is adequately ventilated before breaking into the system or conducting any hot work. A degree of ventilation shall continue during the period that the work is carried out. The ventilation should safely disperse any released refrigerant and preferably expel it externally into the atmosphere.

### 3.5.3.7 Checks to the Refrigeration Equipment

Where electrical components are being changed, they shall be fit for the purpose and to the correct specification. At all times the manufacturer's maintenance and service guidelines shall be followed. If in doubt, consult the manufacturers' technical department for assistance.

The following checks shall be applied to installations using flammable refrigerants:

- (1) The refrigerant name and its rated charge must be accurately filled in accordance with the unit nameplate, and the maximum charge amount cannot exceed 152g.
- (2) The ventilation machinery and outlets are operating adequately and are not obstructed.
- (3) If an indirect refrigerating circuit is being used, the secondary circuit shall be checked for the presence of refrigerant.
- (4) Marking to the equipment continues to be visible and legible. Markings and signs that are illegible shall be corrected.
- (5) Refrigeration pipe or components are installed in a position where they are unlikely to be exposed to any substance which may corrode refrigerant containing components, unless the components are constructed of materials which are inherently resistant to being corroded or are suitably protected against being so corroded.

### 3.5.3.8 Checks to electrical devices

Repair and maintenance to electrical components shall include initial safety checks and component inspection procedures. If a fault exists that could compromise safety, then no electrical supply shall be connected to the circuit until it is satisfactorily dealt with. If the fault cannot be corrected immediately but it is necessary to continue operation, an adequate temporary solution shall be used. This shall be reported to the owner of the equipment so all parties are advised.

Initial safety checks shall include:

- (1) That capacitors are discharged: this shall be done in a safe manner to avoid possibility of sparking;
- (2) That no live electrical components and wiring are exposed while charging, recovering or purging the system;

- (3) That there is continuity of earth bonding.

### 3.5.3.9 Repairs to Sealed Components

During repairs to sealed components, all electrical supplies shall be disconnected from the equipment being worked upon prior to any removal of sealed covers, etc. If it is absolutely necessary to have an electrical supply to equipment during servicing, then a permanently operating form of leak detection shall be located at the most critical point to warn of a potentially hazardous situation.

Particular attention shall be paid to the following to ensure that by working on electrical components, the casing is not altered in such a way that the level of protection is affected. This shall include damage to cables, excessive number of connections, terminals not made to original specification, damage to seals, incorrect fitting of glands, etc.

- (1) Ensure that the apparatus is mounted securely.
- (2) Ensure that seals or sealing materials have not degraded to the point that they no longer serve the purpose of preventing the ingress of flammable atmospheres. Replacement parts shall be in accordance with the manufacturer's specifications.

**Note: The use of silicon sealant can inhibit the effectiveness of some types of leak detection equipment. Intrinsically safe components do not have to be isolated prior to working on them.**

### 3.5.3.10 Repair to Intrinsically Safe Components

Do not apply any permanent inductive or capacitance loads to the circuit without ensuring that this will not exceed the permissible voltage and current permitted for the equipment in use.

Intrinsically safe components are the only types that can be worked on while live in the presence of a flammable atmosphere. The test apparatus shall be at the correct rating.

Replace components only with parts specified by the manufacturer. Other parts may result in the ignition of refrigerant in the atmosphere from a leak.

### 3.5.3.11 Cabling

Check that cabling will not be subject to wear, corrosion, excessive pressure, vibration, sharp edges or any other adverse environmental effects. The check shall also take into account the effects of aging or continual vibration from sources such as compressors or fans.

### 3.5.3.12 Detection of Flammable Refrigerants

Under no circumstances shall potential sources of ignition be used in the searching for or detection of refrigerant leaks. A halide torch (or any other detector using a naked flame) shall not be used.

### 3.5.3.13 Leak Detection Methods

The following leak detection methods are deemed acceptable for all refrigerant systems.

Electronic leak detectors may be used to detect refrigerant leaks but, in the case of flammable refrigerants, the sensitivity may not be adequate, or may need recalibration. (Detection equipment shall be calibrated in a refrigerant-free area.) Ensure that the detector is not a potential source of ignition and is suitable for the refrigerant used. Leak detection equipment shall be set at a percentage of the LFL of the refrigerant and shall be calibrated to the refrigerant employed, and the appropriate percentage of gas (25% maximum) is confirmed.

Leak detection fluids are suitable for use with most refrigerants but the use of detergents containing chlorine shall be avoided as the chlorine may react with the refrigerant and corrode the copper pipe work.

If a leak is suspected, all naked flames shall be removed/extinguished.

If a leakage of refrigerant is found which requires brazing, all of the refrigerant shall be recovered from the system, or isolated (by means of shut off valves) in a part of the system remote from the leak. For appliances containing flammable refrigerants, oxygen free nitrogen (OFN) shall then be purged through the system both before and during the brazing process.

### 3.5.3.14 Removal and Evacuation

When breaking into the refrigerant circuit to make repairs or for any other purpose conventional procedures shall be used. However, for flammable refrigerants it is important that best practice is followed since flammability is a consideration. The following procedure shall be adhered to:

- (1) remove refrigerant;
- (2) purge the circuit with inert gas; evacuate;
- (3) purge again with inert gas;
- (4) open the circuit by cutting or brazing.

The refrigerant charge shall be recovered into the correct recovery cylinders. For appliances containing flammable refrigerants, the system shall be "flushed" with OFN to render the unit safe. This process may need to be repeated several times. Compressed air or oxygen shall not be used for purging refrigerant systems.

For appliances containing flammable refrigerants, flushing shall be achieved by breaking the vacuum in the system with OFN and continuing to fill until the working pressure is achieved, then venting to atmosphere, and finally pulling down to a vacuum. This process shall be repeated until no refrigerant is within the system. When the final OFN charge is used, the system shall be vented down to atmospheric pressure to enable work to take place. This operation is absolutely vital if brazing operations on the pipework are to take place.

Ensure that the outlet for the vacuum pump is not close to any ignition sources and that ventilation is available.

### 3.5.3.15 Charging Procedures

In addition to conventional charging procedures, the following requirements shall be followed.

- (1) Ensure that contamination of different refrigerants does not occur when using charging equipment. Hoses or lines shall be as short as possible to minimise the amount of refrigerant contained in them.
- (2) Cylinders shall be kept upright.
- (3) Ensure that the refrigeration system is earthed prior to charging the system with refrigerant.
- (4) Label the system when charging is complete (if not already).
- (5) Extreme care shall be taken not to overfill the refrigeration system.

Prior to recharging the system, it shall be pressure tested with the appropriate purging gas.

The system shall be leak tested on completion of charging but prior to commissioning. A follow up leak test shall be carried out prior to leaving the site.



### 3.5.3.16 Decommissioning

Before carrying out this procedure, it is essential that the technician is completely familiar with the equipment and all its detail. It is recommended good practice that all refrigerants are recovered safely. Prior to the task being carried out, an oil and refrigerant sample shall be taken in case analysis is required prior to reuse of reclaimed refrigerant. It is essential that electrical power is available before the task is commenced.

- (1) Become familiar with the equipment and its operation.
- (2) Isolate system electrically.
- (3) Before attempting the procedure, ensure that:
- (4) Mechanical handling equipment is available, if required, for handling refrigerant cylinders;
- (5) All personal protective equipment is available and being used correctly;
- (6) The recovery process is supervised at all times by a competent person;
- (7) Recovery equipment and cylinders conform to the appropriate standards.
- (8) Pump down refrigerant system, if possible.
- (9) If a vacuum is not possible, make a manifold so that refrigerant can be removed from various parts of the system.
- (10) Make sure that cylinder is situated on the scales before recovery takes place.
- (11) Start the recovery machine and operate in accordance with manufacturer's instructions.
- (12) Do not overfill cylinders. (No more than 80% volume liquid charge).
- (13) Do not exceed the maximum working pressure of the cylinder, even temporarily.
- (14) When the cylinders have been filled correctly and the process completed, make sure that the cylinders and the equipment are removed from site promptly and all isolation valves on the equipment are closed off.
- (15) Recovered refrigerant shall not be charged into another refrigeration system unless it has been cleaned and checked.

### 3.5.3.17 Labelling

Equipment shall be labelled stating that it has been decommissioned and emptied of refrigerant. The label shall be dated and signed. For appliances containing flammable refrigerants, ensure that there are labels on the equipment stating the equipment contains flammable refrigerant.

### 3.5.3.18 Recovery

When removing refrigerant from a system, either for servicing or decommissioning, it is recommended good practice that all refrigerants are removed safely.

When transferring refrigerant into cylinders, ensure that only appropriate refrigerant recovery cylinders are employed. Ensure that the correct number of cylinders for holding the total system charge are available. All cylinders to be used are designated for the recovered refrigerant and labeled for that refrigerant (i.e. special cylinders for the recovery of refrigerant). Cylinders shall be complete with pressure-relief valve and associated shut-off valves in good working order. Empty recovery cylinders are evacuated and, if possible, cooled before recovery occurs.

The recovery equipment shall be in good working order with a set of instructions concerning the equipment that is at hand and shall be suitable for the recovery of all appropriate refrigerants including,

when applicable, flammable refrigerants. In addition, a set of calibrated weighing scales shall be available and in good working order. Hoses shall be complete with leak-free disconnect couplings and in good condition. Before using the recovery machine, check that it is in satisfactory working order, has been properly maintained and that any associated electrical components are sealed to prevent ignition in the event of a refrigerant release. Consult manufacturer if in doubt.

The recovered refrigerant shall be returned to the refrigerant supplier in the correct recovery cylinder, and the relevant waste transfer note arranged. Do not mix refrigerants in recovery units and especially not in cylinders.

If compressors or compressor oils are to be removed, ensure that they have been evacuated to an acceptable level to make certain that flammable refrigerant does not remain within the lubricant. The evacuation process shall be carried out prior to returning the compressor to the suppliers. Only electric heating to the compressor body shall be employed to accelerate this process. When oil is drained from a system, it shall be carried out safely.

## 4 EXPLODED VIEW AND PARTS LIST

◆ Model: GRS-1.5Pd/TD200ANpA-K, GRS-1.5Pd/TD270ANpA-K

◆ Exploded Views and spare parts list:

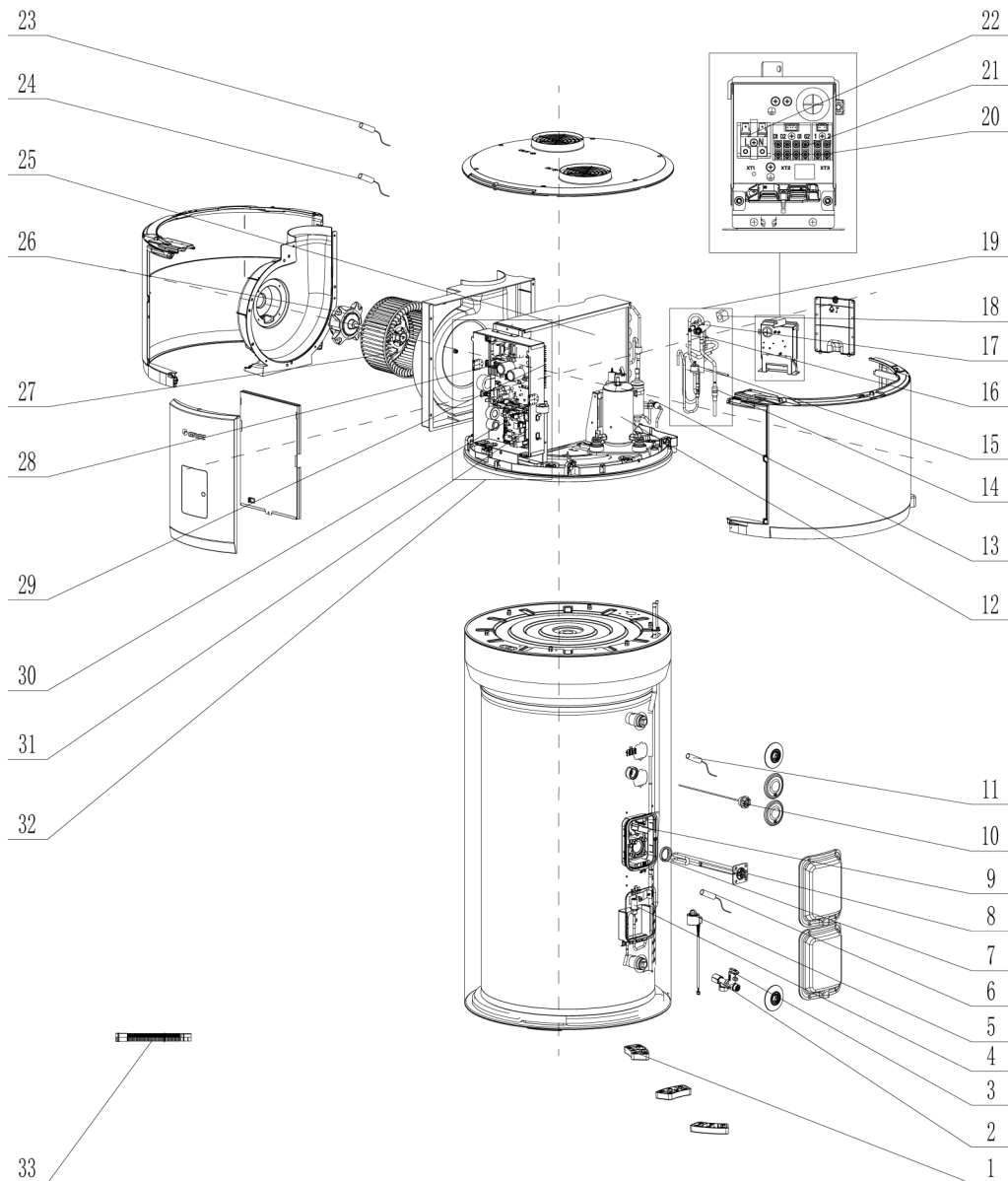

NO.	Name of Part	Part Code	Quantity
1	Water Tank Bottom Feet	26902848	3
2	Water Pipe Connector	035033000012	1
3	Relief Valve	07382801	1
4	Electronic Expansion Valve	072009060053	1
5	Electric Expand Valve Fitting	4304413247	1
6	Temperature Sensor	3900028318G	1
7	Gasket (Rubber) (Electric Heating)	75042800005	1
8	Electric Heater	320005060031	1
9	Thermostat	430003060020	1
10	Electronic Positive Electrode(Auxiliary)	015023000002	1
11	Temperature Sensor	3900028317G	1
12	Compressor and Fittings	009001061056	1
13	Strainer A	0721002201	1

NO.	Name of Part	Part Code	Quantity
14	Strainer	035021060019	1
15	Pressure Protect Switch	46020011	1
16	Nozzle for Adding Freon	061200101	1
17	4-Way Valve	072007060013	1
18	4 Way Valve Coil	43000400130	1
19	4-Way Valve Assy	030152061408	1
20	Terminal Board	42000100000101	1
21	Terminal Board	42200006005405	1
22	Terminal Board	4220000600056	1
23	Temperature Sensor	3900825402G	1
24	Tube sensor	3900012128	1
25	Condenser Assy	011002062491	1
26	Brushless DC Motor	150104060188	1
27	Centrifugal Fan	10452800002	1
28	Main Board	300027063240	1
29	Radiator	43003406014205	1
30	Main Board	300027063276	1
31	Electronic Positive Electrode	0406280000802	1
32	Electric Box Assy	100002080988	1
33	Drain Pipe	05230022	1

Above data is subject to change without notice, please reference the SP in global service website.

## MAINTENANCE

### 1 WATER RECHARGE, DRAINAGE AND CLEANING

The water recharge and drainage of the unit shall be followed up throughout the whole process to avoid water leakage accidents caused by wrong operation. Before the process of water recharge, drainage or cleaning, please turn off the power supply.

#### 1.1 Water Recharge

- (1) Open the cold water inlet valve.
- (2) Fill the unit with water by opening the hot water outlet valve and a hot water tap.
- (3) Once water flows from the hot water tap, ensure all air in the system is bled then close the hot water tap.

#### 1.2 Water Drainage

- (1) Close the cold water inlet valve & open a hot water tap.
- (2) Open the drainage pipe valve; drain out all the water in the inner tank.
- (3) Close the drainage pipe valve, re-fill the inner tank with water, and turn the power back on.

#### 1.3 Cleaning of Water Tank of the Unit

Repeat the water drainage and recharge operations until the water discharged from the water tank of the unit is clear. Please clean the water tank periodically (every half year) to get good-quality water.

### 2 MAINTENANCE OF ANODE ROD

The unit adopts electronic anode for corrosion prevention.

For the water tank of the unit with electronic anode, do not cut off the power after the unit is shut down, otherwise the electronic anode won't have the function of protecting the inner tank of the water tank. If the unit won't be used for a long time, it will inevitably need to cut off the power supply. Please be sure to drain the water in the water tank and pipeline!

### 3 MAINTENANCE OF SAFETY VALVE

The safety valve handle should be opened regularly for inspection. It is recommended to check every six months.

If there is no water flowing out, it means that the safety valve is blocked. Please replace it with the same model of safety valve.

During heating operation, the water tank will discharge a small amount of water through the safety valve, which is a normal pressure relief phenomenon. However, if there is obvious large-flow drainage or even pipeline vibration, please apply for maintenance.

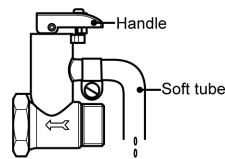

Fig.3-1 Diagram of safety valve

### 4 MAINTENANCE IN WINTER

When using this product in winter (the temperature may be lower than 0°C), please ensure that the unit is always energized. If the unit won't be used, make sure to drain the water in the water tank and pipeline of the unit to avoid freezing and cracking of the system.

## ATTACHMENT

### TABLE OF THE TEMPERATURE SENSOR RESISTANCE AND TEMPERATURE

The following tables list the mapping relationship between resistance of different temperature sensors and temperature. The resistance for different temperature can be queried during maintenance.

**NOTE:** Due to variance in measuring method and temperature sensing, the sensor resistance may deviate at  $\pm 5^{\circ}\text{C}$ .

(1) Temperature sensor of 15 k $\Omega$  (ambient temperature sensor)

Temperature (°C)	Resistance (k $\Omega$ )	Temperature (°C)	Resistance (k $\Omega$ )	Temperature (°C)	Resistance (k $\Omega$ )
-19	138.1	41	7.653	101	0.98
-18	128.6	42	7.352	102	0.952
-17	121.6	43	7.065	103	0.925
-16	115	44	6.791	104	0.898
-15	108.7	45	6.529	105	0.873
-14	102.9	46	6.278	106	0.848
-13	97.4	47	6.038	107	0.825
-12	92.22	48	5.809	108	0.802
-11	87.35	49	5.589	109	0.779
-10	82.75	50	5.379	110	0.758
-9	78.43	51	5.179	111	0.737
-8	74.35	52	4.986	112	0.717
-7	70.5	53	4.802	113	0.697
-6	66.88	54	4.625	114	0.678
-5	63.46	55	4.456	115	0.66
-4	60.23	56	4.294	116	0.642
-3	57.18	57	4.139	117	0.625
-2	54.31	58	3.99	118	0.608
-1	51.59	59	3.848	119	0.592
0	49.02	60	3.711	120	0.577
1	46.8	61	3.579	121	0.561
2	44.31	62	3.454	122	0.547
3	42.14	63	3.333	123	0.532
4	40.09	64	3.217	124	0.519
5	38.15	65	3.105	125	0.505
6	36.32	66	2.998	126	0.492
7	34.58	67	2.898	127	0.48
8	32.94	68	2.797	128	0.467
9	31.38	69	2.702	129	0.456
10	29.9	70	2.611	130	0.444
11	28.51	71	2.523	131	0.433
12	27.18	72	2.439	132	0.422
13	25.92	73	2.358	133	0.412
14	24.73	74	2.28	134	0.401

Temperature (°C)	Resistance (kΩ)	Temperature (°C)	Resistance (kΩ)	Temperature (°C)	Resistance (kΩ)
15	23.6	75	2.205	135	0.391
16	22.53	76	2.133	136	0.382
17	21.51	77	2.064	137	0.372
18	20.54	78	1.997	138	0.363
19	19.63	79	1.933	139	0.355
20	18.75	80	1.871	140	0.346
21	17.93	81	1.811	141	0.338
22	17.14	82	1.754	142	0.33
23	16.39	83	1.699	143	0.322
24	15.68	84	1.645	144	0.314
25	15	85	1.594	145	0.307
26	14.36	86	1.544	146	0.299
27	13.74	87	1.497	147	0.292
28	13.16	88	1.451	148	0.286
29	12.6	89	1.408	149	0.279
30	12.07	90	1.363	150	0.273
31	11.57	91	1.322	151	0.266
32	11.09	92	1.282	152	0.261
33	10.63	93	1.244	153	0.254
34	10.2	94	1.207	154	0.248
35	9.779	95	1.171	155	0.243
36	9.382	96	1.136	156	0.237
37	9.003	97	1.103	157	0.232
38	8.642	98	1.071	158	0.227
39	7.997	99	1.039	159	0.222
40	7.825	100	1.009	160	0.217

(2) Temperature sensor of 20 kΩ (suction temperature sensor and tube temperature sensor)

Temperature (°C)	Resistance (kΩ)	Temperature (°C)	Resistance (kΩ)	Temperature (°C)	Resistance (kΩ)
-30	361.8	34	13.59	98	1.427
-29	339.8	35	13.04	99	1.386
-28	319.2	36	12.51	100	1.346
-27	300	37	12	101	1.307
-26	282.2	38	11.52	102	1.269
-25	265.5	39	11.06	103	1.233
-24	249.9	40	10.62	104	1.198
-23	235.3	41	10.2	105	1.164
-22	221.6	42	9.803	106	1.131
-21	208.9	43	9.42	107	1.099
-20	196.9	44	9.054	108	1.069
-19	181.4	45	8.705	109	1.039
-18	171.4	46	8.37	110	1.01
-17	162.1	47	8.051	111	0.9825
-16	153.3	48	7.745	112	0.9556

Temperature (°C)	Resistance (kΩ)	Temperature (°C)	Resistance (kΩ)	Temperature (°C)	Resistance (kΩ)
-15	145	49	7.453	113	0.9295
-14	137.2	50	7.173	114	0.9043
-13	129.9	51	6.905	115	0.8799
-12	123	52	6.648	116	0.8562
-11	116.5	53	6.403	117	0.8333
-10	110.3	54	6.167	118	0.8111
-9	104.6	55	5.942	119	0.7895
-8	99.13	56	5.726	120	0.7687
-7	94	57	5.519	121	0.7485
-6	89.17	58	5.32	122	0.7289
-5	84.61	59	5.13	123	0.7099
-4	80.31	60	4.948	124	0.6915
-3	76.24	61	4.773	125	0.6736
-2	72.41	62	4.605	126	0.6563
-1	68.79	63	4.443	127	0.6395
0	65.37	64	4.289	128	0.6232
1	62.13	65	4.14	129	0.6074
2	59.08	66	3.998	130	0.5921
3	56.19	67	3.861	131	0.5772
4	53.46	68	3.729	132	0.5627
5	50.87	69	3.603	133	0.5487
6	48.42	70	3.481	134	0.5351
7	46.11	71	3.364	135	0.5219
8	43.92	72	3.252	136	0.509
9	41.84	73	3.144	137	0.4966
10	39.87	74	3.04	138	0.4845
11	38.01	75	2.94	139	0.4727
12	36.24	76	2.844	140	0.4613
13	34.57	77	2.752	141	0.4502
14	32.98	78	2.663	142	0.4394
15	31.47	79	2.577	143	0.4289
16	30.04	80	2.495	144	0.4187
17	28.68	81	2.415	145	0.4088
18	27.39	82	2.339	146	0.3992
19	26.17	83	2.265	147	0.3899
20	25.01	84	2.194	148	0.3808
21	23.9	85	2.125	149	0.3719
22	22.85	86	2.059	150	0.3633
23	21.85	87	1.996	151	0.3549
24	20.9	88	1.934	152	0.3468
25	20	89	1.875	153	0.3389
26	19.14	90	1.818	154	0.3312
27	18.32	91	1.763	155	0.3237
28	17.55	92	1.71	156	0.3164



Temperature (°C)	Resistance (kΩ)	Temperature (°C)	Resistance (kΩ)	Temperature (°C)	Resistance (kΩ)
29	16.8	93	1.658	157	0.3093
30	16.1	94	1.609	158	0.3024
31	15.43	95	1.561	159	0.2956
32	14.79	96	1.515	160	0.2891
33	14.18	97	1.47	—	—

(3) Temperature sensor of 50 kΩ (discharge temperature sensor and water temperature sensors)

Temperature (°C)	Resistance (kΩ)	Temperature (°C)	Resistance (kΩ)	Temperature (°C)	Resistance (kΩ)
-29	853.66	31	37.958	91	4.3345
-28	799.98	32	36.384	92	4.2044
-27	750.18	33	34.883	93	4.0789
-26	703.92	34	33.453	94	3.9579
-25	660.93	35	32.088	95	3.841
-24	620.94	36	30.787	96	3.7283
-23	583.72	37	29.544	97	3.6194
-22	549.04	38	28.359	98	3.5143
-21	516.71	39	27.227	99	3.4128
-20	486.55	40	26.147	100	3.3147
-19	458.4	41	25.114	101	3.22
-18	432.1	42	24.128	102	3.1285
-17	407.51	43	23.186	103	3.0401
-16	384.51	44	22.286	104	2.9547
-15	362.99	45	21.425	105	2.8721
-14	342.83	46	20.601	106	2.7922
-13	323.94	47	19.814	107	2.715
-12	306.23	48	19.061	108	2.6404
-11	289.61	49	18.34	109	2.5682
-10	274.02	50	17.651	110	2.4983
-9	259.37	51	16.99	111	2.4308
-8	245.61	52	16.358	112	2.3654
-7	232.67	53	15.753	113	2.3021
-6	220.5	54	15.173	114	2.2409
-5	209.05	55	14.618	115	2.1816
-4	195.97	56	14.085	116	2.1242
-3	188.12	57	13.575	117	2.0686
-2	178.65	58	13.086	118	2.0148
-1	169.68	59	12.617	119	1.9626
0	161.02	60	12.368	120	1.9123
1	153	61	11.736	121	1.8652
2	145.42	62	11.322	122	1.8158
3	135.96	63	10.925	123	1.7698
4	131.5	64	10.544	124	1.7253
5	126.17	65	10.178	125	1.6821
6	119.08	66	9.8269	126	1.6402

Temperature (°C)	Resistance (kΩ)	Temperature (°C)	Resistance (kΩ)	Temperature (°C)	Resistance (kΩ)
7	113.37	67	9.4896	127	1.5996
8	107.96	68	9.1655	128	1.5602
9	102.85	69	8.9542	129	1.522
10	98.006	70	8.5551	130	1.485
11	93.42	71	5.9676	131	1.449
12	89.075	72	7.9913	132	1.4141
13	84.956	73	7.7257	133	1.3803
14	81.052	74	7.4702	134	1.3474
15	77.349	75	7.2245	135	1.3155
16	73.896	76	6.9882	136	1.2846
17	70.503	77	6.7608	137	1.2545
18	67.338	78	6.542	138	1.2233
19	64.333	79	6.3315	139	1.1969
20	61.478	80	6.1288	140	1.1694
21	58.766	81	5.9336	141	1.1476
22	56.189	82	5.7457	142	1.1166
23	53.738	83	5.5647	143	1.0913
24	51.408	84	5.3903	144	1.0667
25	49.191	85	5.2223	145	1.0429
26	47.082	86	5.0605	146	1.0197
27	45.074	87	4.9044	147	0.9971
28	43.163	88	4.7541	148	0.9752
29	41.313	89	4.6091	149	0.9538
30	39.61	90	4.4693	150	0.9331



GREE ELECTRIC APPLIANCES, INC. OF ZHUHAI 519070

Add: West Jinji Rd, Qianshan Zhuhai, Guangdong, China

Tel: (+86-756)8522218

Fax: (+86-756)8669426

E-mail: [global@cn.gree.com](mailto:global@cn.gree.com) [www.gree.com](http://www.gree.com)

JF00305550