



# Service Manual

**GREE ELECTRIC APPLIANCES, INC. OF ZHUHAI**



# Table of Contents

<b>Part I : Technical Information</b> .....	1
<b>1. Summary</b> .....	1
<b>2. Specifications</b> .....	2
2.1 Specification Sheet.....	2
2.2 Capacity Variation Ratio According to Temperature .....	6
2.3 Cooling and Heating Data Sheet in Rated Frequency.....	7
2.4 Noise Curve.....	7
<b>3. Outline Dimension Diagram</b> .....	8
3.1 Indoor Unit.....	8
3.2 Outdoor Unit.....	9
<b>4. Refrigerant System Diagram</b> .....	11
<b>5. Electrical Part</b> .....	12
5.1 Wiring Diagram .....	12
5.2 PCB Printed Diagram.....	15
<b>6. Function and Control</b> .....	19
6.1 Remote Controller Introduction .....	19
6.2 GREE+ App Operation Manual .....	25
6.3 Ewpe Smart App Operation Manual.....	26
6.4 Brief Description of Modes and Functions .....	27
<b>Part II : Installation and Maintenance</b> .....	34
<b>7. Notes for Installation and Maintenance</b> .....	34
<b>8. Installation</b> .....	38
8.1 Installation Dimension Diagram.....	38
8.2 Installation Parts-checking .....	40
8.3 Selection of Installation Location.....	40
8.4 Requirements for electric connection .....	40



# Part I : Technical Information

## 1. Summary

**Indoor Unit:**

GWH09UB-K6DNA4A/I  
 GWH12UB-K6DNA4A/I  
 GWH18UC-K6DNA4A/I

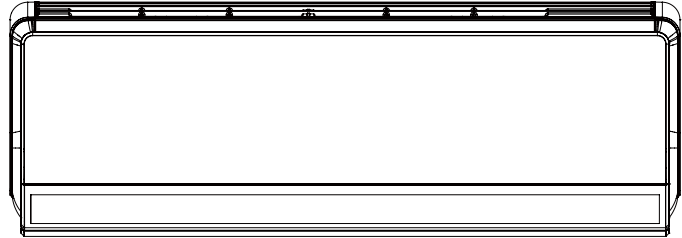

**Outdoor Unit:**

GWH09UB-K6DNA4A/O

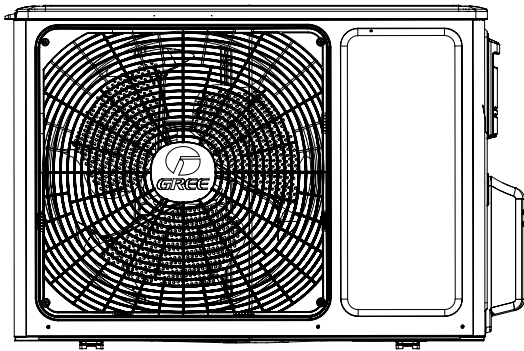

GWH18UC-K6DNA4A/O

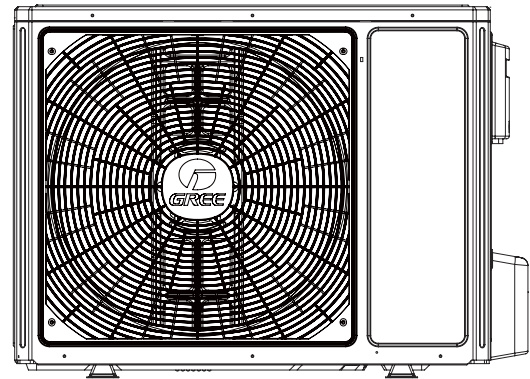

GWH12UB-K6DNA4A/O

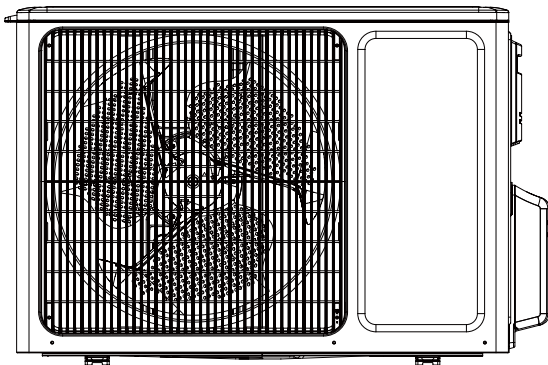

**Remote Controller:**

SAA1FB1



**Models List:**

No	Model	Product code	Indoor model	Indoor product code	Outdoor model	Outdoor product code	Remote Controller
1	GWH09UB-K6DNA4A	CB264002100	GWH09UB-K6DNA4A/I	CB264N02100	GWH09UB-K6DNA4A/O	CB264W02100	SAA1FB1
2		CB264002101		CB264N02101			
3	GWH12UB-K6DNA4A	CB264002200	GWH12UB-K6DNA4A/I	CB264N02200	GWH12UB-K6DNA4A/O	CB264W02200	
4		CB264002201		CB264N02201			
5	GWH18UC-K6DNA4A	CB264002000	GWH18UC-K6DNA4A/I	CB264N02000	GWH18UC-K6DNA4A/O	CB264W02000	
6		CB264002001		CB264N02001			

## 2. Specifications

### 2.1 Specification Sheet

Parameter		Unit	Value	
Model			GWH09UB-K6DNA4A	GWH12UB-K6DNA4A
Product Code			CB264002100/CB264002101	CB264002200/CB264002201
Power Supply	Rated Voltage	V~	220-240	220-240
	Rated Frequency	Hz	50	50
	Phases		1	1
Power Supply Mode			Outdoor	Outdoor
Cooling Capacity		W	2700	3530
Heating Capacity		W	3200	4000
Cooling Power Input		W	600	883
Heating Power Input		W	780	1000
Cooling Power Current		A	3.68	5.8
Heating Power Current		A	4.42	6.8
Rated Input		W	2300	2400
Rated Current		A	10.5	10.5
Air Flow Volume (SH/H/MH/M/ML/L/SL/SM)		m <sup>3</sup> /h	550/450/390/330/290/250/220/180	650/500/450/400/330/250/200/180
Dehumidifying Volume		L/h	0.8	0.8
EER		W/W	4.50	4.00
COP		W/W	4.10	4.00
SEER			7.5	7.2
SCOP(Average/Warmer/Colder)			4.6/5.7/3.6	4.6/5.5/3.6
Application Area		m <sup>2</sup>	12-18	16-24
Indoor Unit	Model		GWH09UB-K6DNA4A/I	GWH12UB-K6DNA4A/I
	Product Code		CB264N02100/CB264N02101	CB264N02200/CB264N02201
	Fan Type		Cross-flow	Cross-flow
	Diameter Length(DXL)	mm	Φ92X616	Φ92X616
	Fan Motor Cooling Speed	r/min	1350/1127/1000/870/780/690/600/550	1400/1185/1053/920/829/741/650/550
	Fan Motor Heating Speed	r/min	1400/1151/1074/1000/930/842/750	1500/1185/1119/1053/958/842/750
	Output of Fan Motor	W	10	10
	Fan Motor RLA	A	0.3	0.3
	Fan Motor Capacitor	μF	/	/
	Input of Heater	W	/	/
	Evaporator Form		Aluminum Fin-copper Tube	Aluminum Fin-copper Tube
	Pipe Diameter	mm	Φ7	Φ7
	Row-fin Gap	mm	2-1.5	2-1.5
	Coil Length (LXDXW)	mm	623X25.4X304.8	623X25.4X304.8
	Swing Motor Model		MP24HD/MP20AC	MP24HD/MP20AC
	Output of Swing Motor	W	1.5/1.5	1.5/1.5
	Fuse	A	3.15	3.15
	Sound Pressure Level	dB (A)	Cooling:41/36/32/28/25/23/20/19 Heating:41/36/34/32/29/26/24	Cooling:42/37/33/29/26/23/21/19 Heating:43/37/35/33/29/26/24
	Sound Power Level	dB (A)	Cooling:57/50/46/42/39/37/34/33 Heating:57/50/48/46/43/40/38	Cooling:58/51/47/43/40/37/35/33 Heating:58/51/49/47/43/40/38
	Dimension (WXHxD)	mm	860X305X170	860X305X170
	Dimension of Carton Box (LXWXH)	mm	932X385X280	932X385X280
Dimension of Package (LXWXH)	mm	935X388X295	935X388X295	
Net Weight	kg	11.5	11.5	
Gross Weight	kg	14	14	

Outdoor Unit	Model		GWH09UB-K6DNA4A/O	GWH12UB-K6DNA4A/O
	Product Code		CB264W02100	CB264W02200
	Compressor Manufacturer/Trademark		ZHUHAI LANDA COMPRESSOR CO., LTD	ZHUHAI LANDA COMPRESSOR CO., LTD
	Compressor Model		QXFT-B123zE170B	QXFT-B123zE170B
	Compressor Oil		FW68DA	FW68DA
	Compressor Type		Rotary	Rotary
	L.R.A.	A	20	20
	Compressor RLA	A	7.9	7.9
	Compressor Power Input	W	1230	1230
	Overload Protector		HPC115/95U1/KSD115°C	HPC115/95U1/KSD115°C
	Throttling Method		Electron expansion valve	Electron expansion valve
	Operation temp	°C	16~30	16~30
	Ambient temp (cooling)	°C	-18~54	-18~54
	Ambient temp (heating)	°C	-30~24	-30~24
	Condenser Form		Aluminum Fin-copper Tube	Aluminum Fin-copper Tube
	Pipe Diameter	mm	Φ7	Φ7
	Rows-fin Gap	mm	2-1.4	2.5-1.4
	Coil Length (LXDXW)	mm	783X38.1X550	763X57X550
	Fan Motor Speed	rpm	850	850
	Output of Fan Motor	W	30	30
	Fan Motor RLA	A	0.24	0.24
	Fan Motor Capacitor	μF	/	/
	Air Flow Volume of Outdoor Unit	m <sup>3</sup> /h	2400	2400
	Fan Type		Axial-flow	Axial-flow
	Fan Diameter	mm	Φ438	Φ438
	Defrosting Method		Automatic Defrosting	Automatic Defrosting
	Climate Type		T1	T1
	Isolation		I	I
	Moisture Protection		IPX4	IPX4
	Permissible Excessive Operating Pressure for the Discharge Side	MPa	4.3	4.3
	Permissible Excessive Operating Pressure for the Suction Side	MPa	2.5	2.5
	Sound Pressure Level	dB (A)	52	53
	Sound Power Level	dB (A)	62	63
	Dimension (WXHxD)	mm	899X596X378	899X596X378
	Dimension of Carton Box (LXWXH)	mm	945X417X630	945X417X630
	Dimension of Package (LXWXH)	mm	948X420X645	948X420X645
Net Weight	kg	42	43.5	
Gross Weight	kg	45	46.5	
Refrigerant		R32	R32	
Refrigerant Charge	kg	0.95	0.9	
Connection Pipe	Length	m	5	5
	Gas Additional Charge	g/m	16	16
	Outer Diameter Liquid Pipe		1/4"	1/4"
	Outer Diameter Gas Pipe		3/8"	3/8"
	Max Distance Height	m	10	10
	Max Distance Length	m	15	20
Note: The connection pipe applies metric diameter.				

The above data is subject to change without notice; please refer to the nameplate of the unit.

Parameter	Unit	Value
Model		GWH18UC-K6DNA4A
Product Code		CB264002000/CB264002001
Power Supply	Rated Voltage	V~ 220-240
	Rated Frequency	Hz 50
	Phases	1
Power Supply Mode		Outdoor
Cooling Capacity	W	5300
Heating Capacity	W	5300
Cooling Power Input	W	1450
Heating Power Input	W	1420
Cooling Power Current	A	6.5
Heating Power Current	A	6.5
Rated Input	W	2500
Rated Current	A	10.6
Air Flow Volume	m <sup>3</sup> /h	850/750/650/600/500/400/340
Dehumidifying Volume	L/h	2.0
EER	W/W	3.66
COP	W/W	3.73
SEER		6.8
SCOP(Average/Warmer/Colder)		4/5.1/3.1
Application Area	m <sup>2</sup>	23-34
Indoor Unit	Model	GWH18UC-K6DNA4A/I
	Product Code	CB264N02000/CB264N02001
	Fan Type	Cross-flow
	Diameter Length(DXL)	mm $\Phi$ 107X699
	Fan Motor Cooling Speed	r/min 1350/1150/1050/930/800/700/650/600
	Fan Motor Heating Speed	r/min 1400/1200/1100/1000/900/800/750
	Output of Fan Motor	W 20
	Fan Motor RLA	A 0.44
	Fan Motor Capacitor	$\mu$ F /
	Input of Heater	W /
	Evaporator Form	Aluminum Fin-copper Tube
	Pipe Diameter	mm $\Phi$ 7
	Row-fin Gap	mm 2-1.5
	Coil Length (LXDXW)	mm 706X25.4X303.8
	Swing Motor Model	MP24HV/MP24AQ
	Output of Swing Motor	W 1.5/1.5
	Fuse	A 3.15
	Sound Pressure Level	dB (A) Cooling:46/40/37/33/28/24/22/20 Heating:49/43/41/38/36/32/28
	Sound Power Level	dB (A) Cooling:56/50/47/43/38/34/32/30 Heating:60/53/51/48/46/42/38
	Dimension (WXHDX)	mm 960X320X205
	Dimension of Carton Box (LXWXH)	mm 1040X400X318
Dimension of Package (LXWXH)	mm 1043X403X333	
Net Weight	kg 14	
Gross Weight	kg 17	

Outdoor Unit	Model		GWH18UC-K6DNA4A/O	
	Product Code		CB264W02000	
	Compressor Manufacturer/Trademark		ZHUHAI LANDA COMPRESSOR CO., LTD	
	Compressor Model		QXFT-B123zE170B	
	Compressor Oil		FW68DA or equivalent	
	Compressor Type		Rotary	
	L.R.A.	A		20
	Compressor RLA	A		7.9
	Compressor Power Input	W		1230
	Overload Protector			HPC115/95orKSD115°C
	Throttling Method			Electron expansion valve
	Operation temp	°C		16~30
	Ambient temp (cooling)	°C		-18~54
	Ambient temp (heating)	°C		-30~24
	Condenser Form			Aluminum Fin-copper Tube
	Pipe Diameter	mm		Φ7
	Rows-fin Gap	mm		2-1.4
	Coil Length (LXDXW)	mm		852X38.1X660
	Fan Motor Speed	rpm		820
	Output of Fan Motor	W		60
	Fan Motor RLA	A		0.5
	Fan Motor Capacitor	μF		/
	Air Flow Volume of Outdoor Unit	m <sup>3</sup> /h		3200
	Fan Type			Axial-flow
	Fan Diameter	mm		Φ520
	Defrosting Method			Automatic Defrosting
	Climate Type			T1
	Isolation			I
	Moisture Protection			IPX4
	Permissible Excessive Operating Pressure for the Discharge Side	MPa		4.3
	Permissible Excessive Operating Pressure for the Suction Side	MPa		2.5
	Sound Pressure Level	dB (A)		57
Sound Power Level	dB (A)		64	
Dimension (WXHxD)	mm		965X700X396	
Dimension of Carton Box (LXWXH)	mm		1026X455X735	
Dimension of Package (LXWXH)	mm		1029X458X750	
Net Weight	kg		50.5	
Gross Weight	kg		55	
Refrigerant			R32	
Refrigerant Charge	kg		1.4	
Connection Pipe	Length	m	5	
	Gas Additional Charge	g/m	16	
	Outer Diameter Liquid Pipe		1/4"	
	Outer Diameter Gas Pipe		1/2"	
	Max Distance Height	m	10	
	Max Distance Length	m	25	
Note: The connection pipe applies metric diameter.				

The above data is subject to change without notice; please refer to the nameplate of the unit.



## 2.2 Capacity Variation Ratio According to Temperature

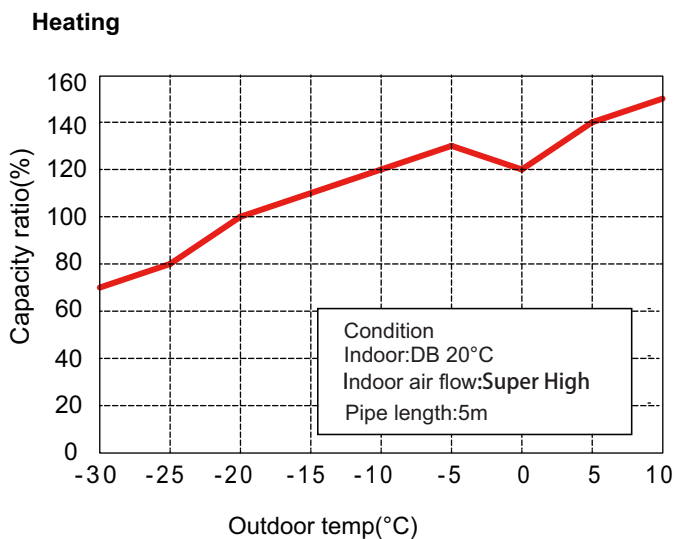
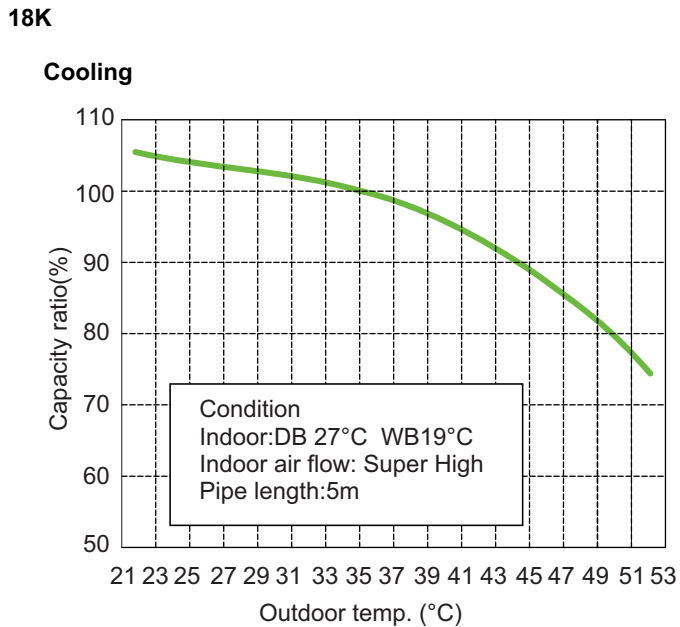
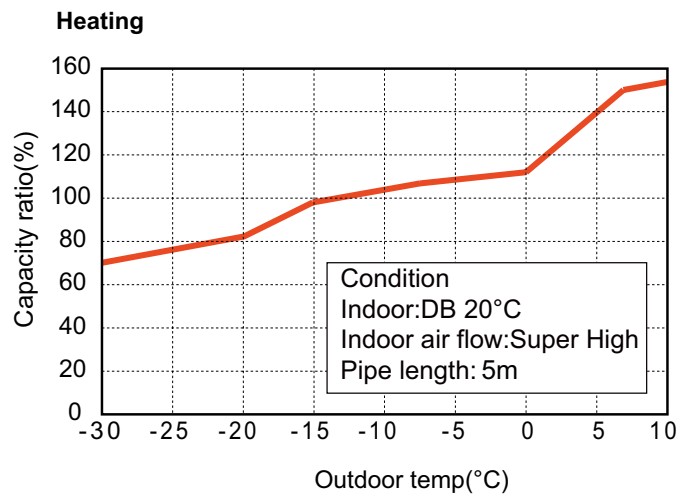
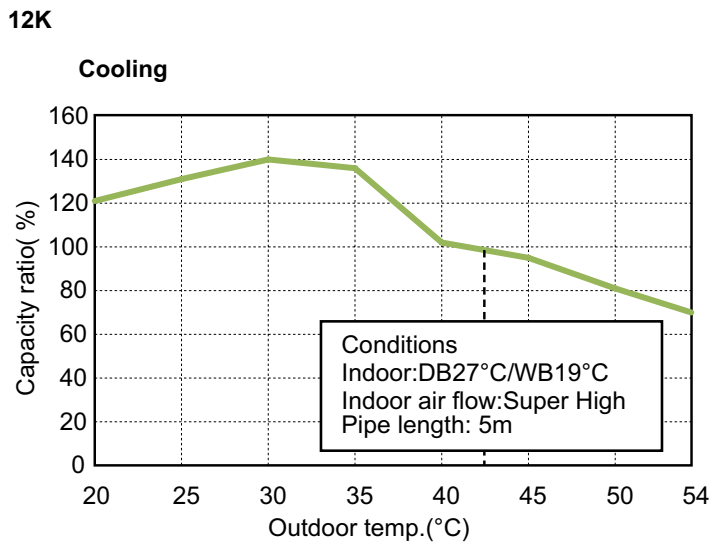
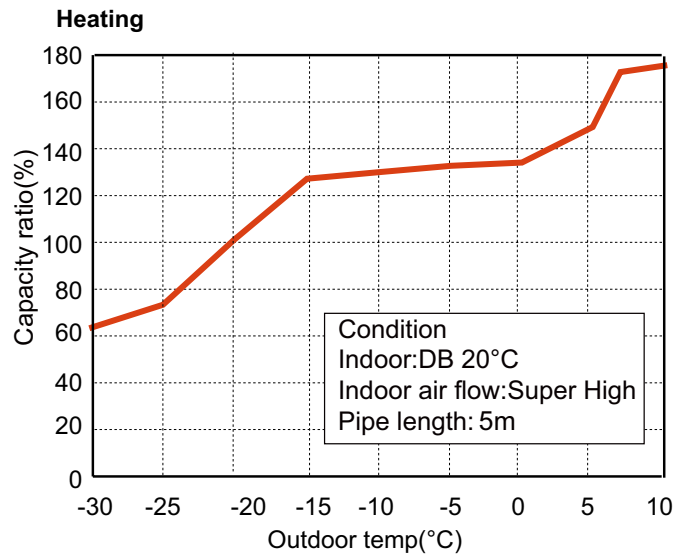
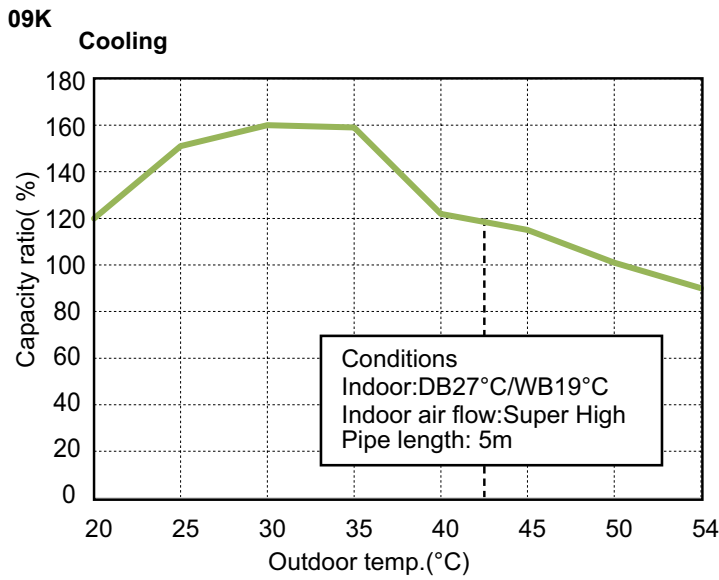

## 2.3 Cooling and Heating Data Sheet in Rated Frequency

Cooling:

Rated cooling condition(°C) (DB/WB)		Model	Pressure of gas pipe connecting indoor and outdoor unit	Inlet and outlet pipe temperature of heat exchanger		Fan speed of indoor unit	Fan speed of outdoor unit	Compressor revolution (Hz)
Indoor	Outdoor			T1 (°C)	T2 (°C)			
27/19	35/24	09/12K	0.9 to 1.1	12 to 14	75 to 37	Super High	High	66
27/19	35/24	18K	0.9 to 1.0	in:8~11 out:11~14	in:75~83 out:37~48	Super High	High	73

Heating:

Rated heating condition(°C) (DB/WB)		Model	Pressure of gas pipe connecting indoor and outdoor unit	Inlet and outlet pipe temperature of heat exchanger		Fan speed of indoor unit	Fan speed of outdoor unit	Compressor revolution (Hz)
Indoor	Outdoor			T1 (°C)	T2 (°C)			
20/-	7/6	09/12K	2.8 to 3.0	70 to 35	2 to 4	Super High	High	66
20/15	7/6	18K	2.2 to 2.4	in:75~83 out:37~45	in:1~3 out:2~6	Super High	High	75

**Instruction:**

T1: Inlet and outlet pipe temperature of evaporator

T2: Inlet and outlet pipe temperature of condenser

P: Pressure at the side of big valve

Connection pipe length: 5 m.

## 2.4 Noise Curve

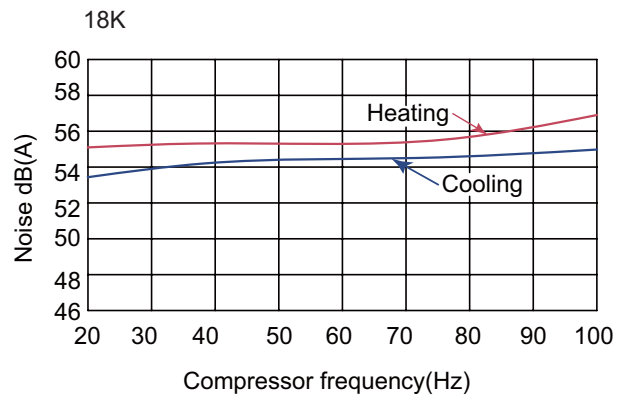
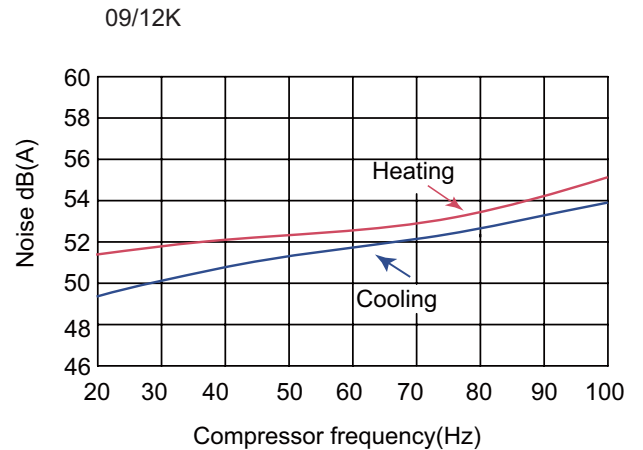
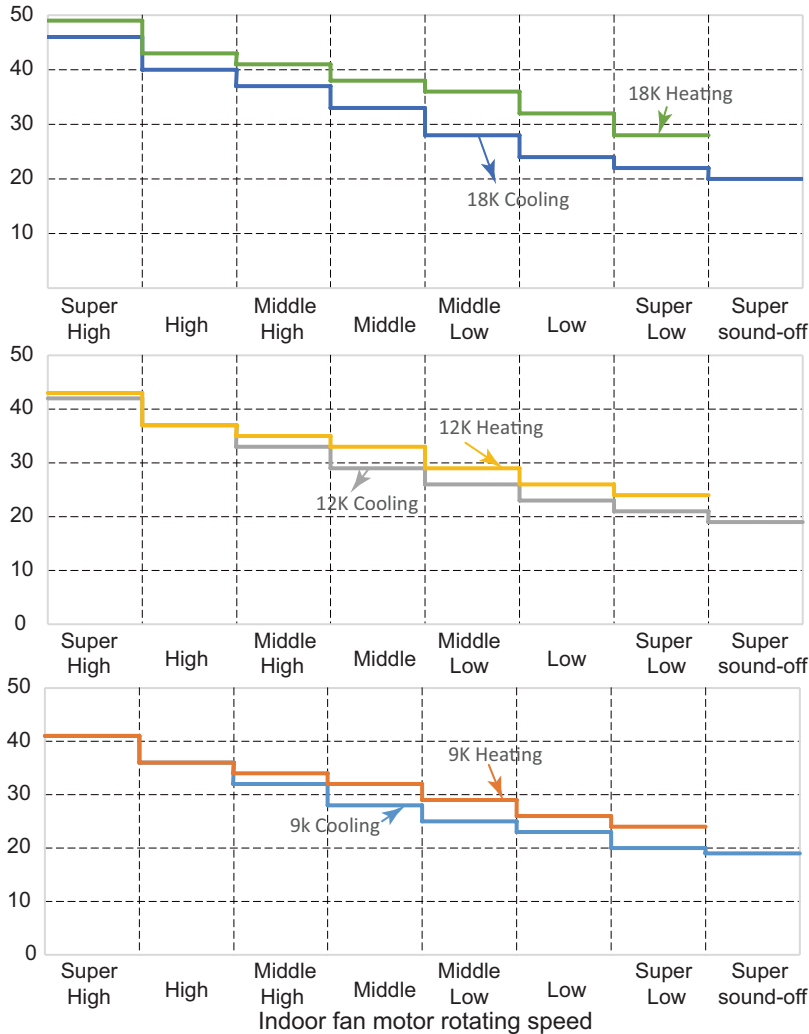

### 3. Outline Dimension Diagram

#### 3.1 Indoor Unit

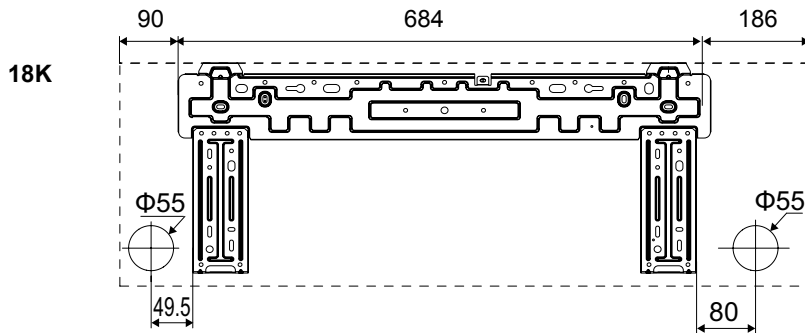
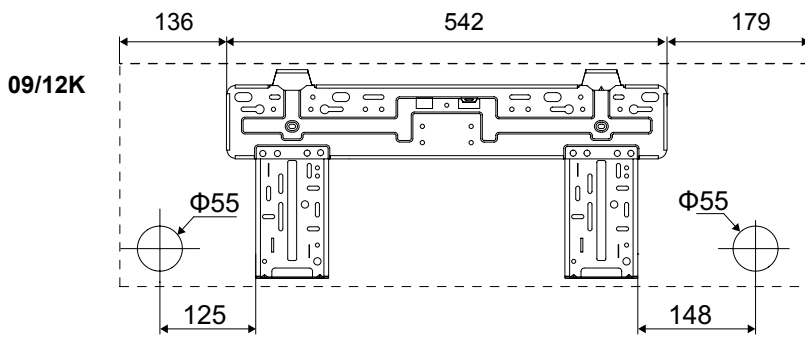
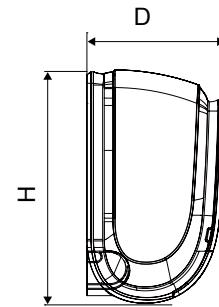
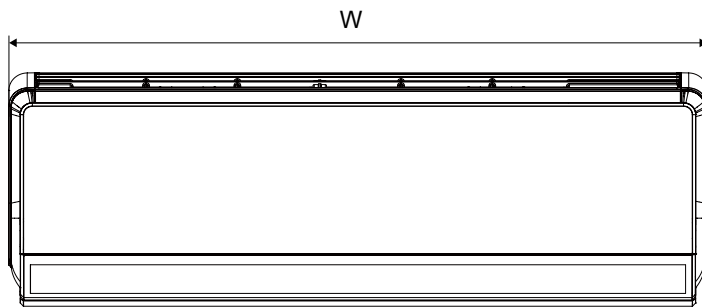

Unit:mm

Model	W	H	D
09/12K	860	305	170
18K	960	320	205



GWH12UB-K6DNA4A/O

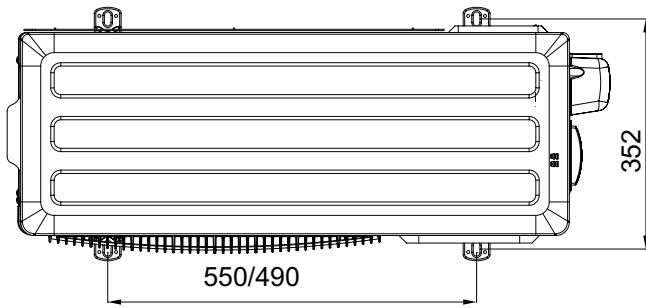
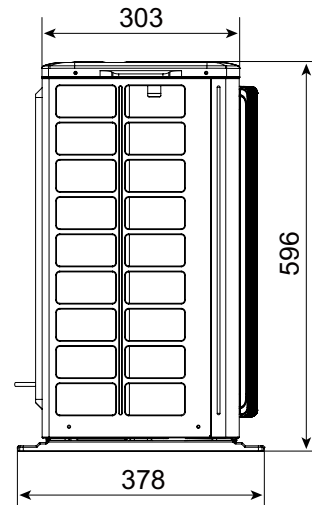
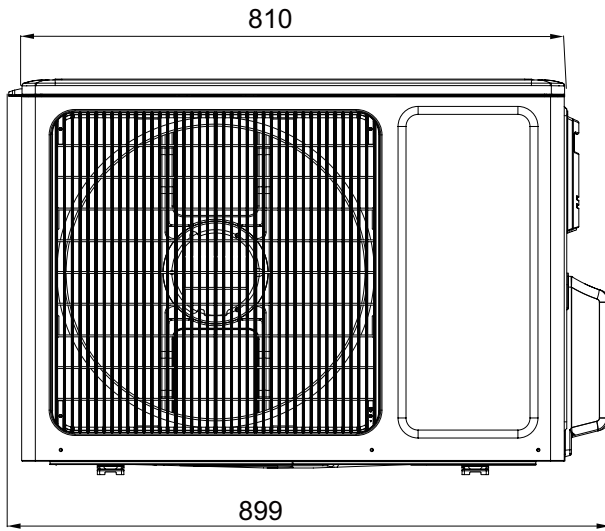

Unit:mm

## 4. Refrigerant System Diagram

09/12K

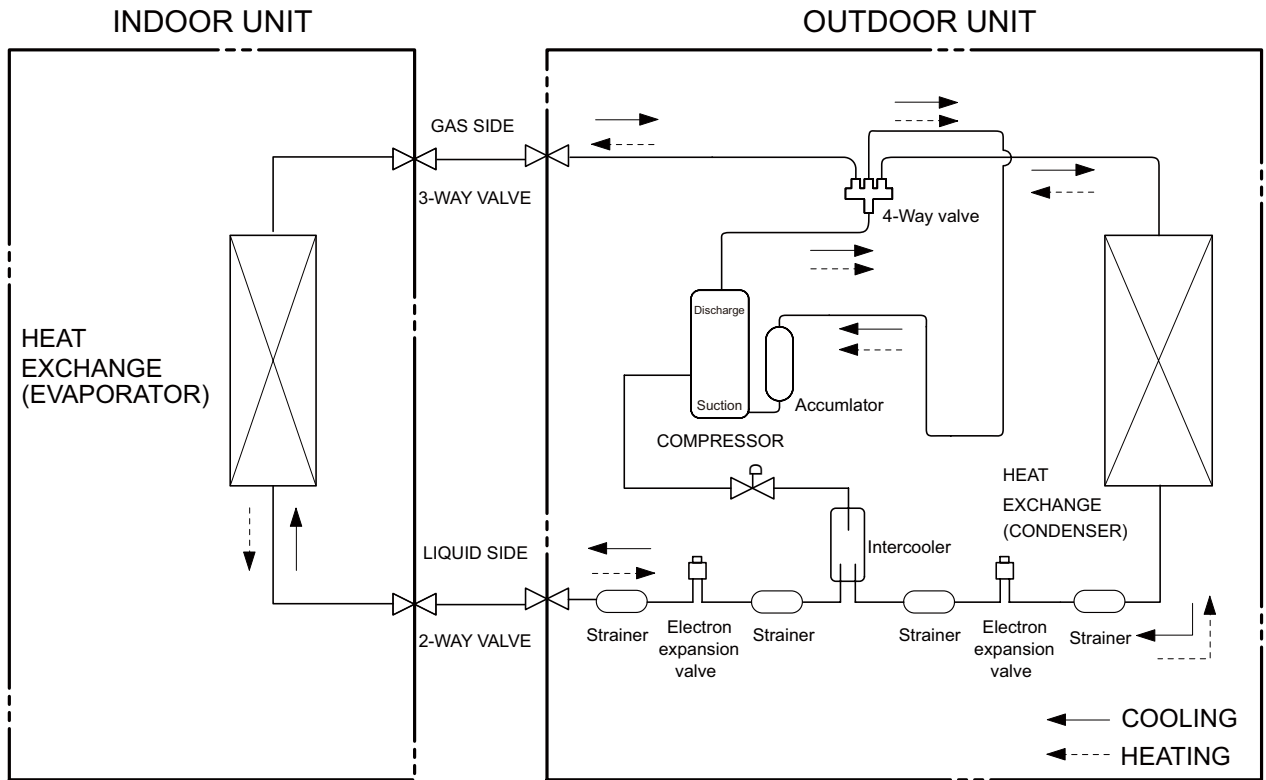

18K

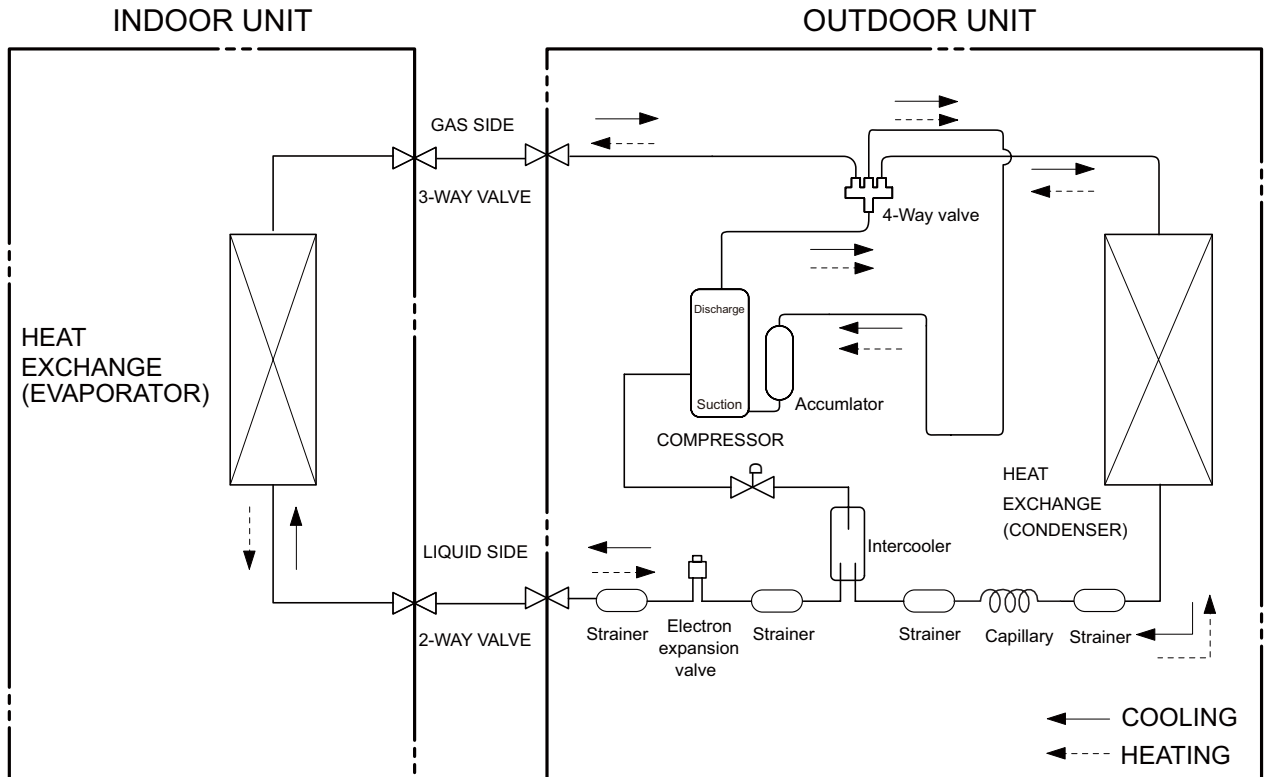

Connection pipe specification:  
Liquid : 1/4"  
Gas pipe: 3/8" (09/12K) 1/2" (18K)

# 5. Electrical Part

## 5.1 Wiring Diagram

### • Instruction

Symbol	Symbol Color	Symbol	Symbol Color	Symbol	Name
WH	White	GN	Green	CAP	Jumper cap
YE	Yellow	BN	Brown	COMP	Compressor
RD	Red	BU	Blue		Grounding wire
YEGN	Yellow/Green	BK	Black	/	/
VT	Violet	OG	Orange	/	/

Note: Jumper cap is used to determine fan speed and the swing angle of horizontal lever for this model.

### • Indoor Unit

9/12K

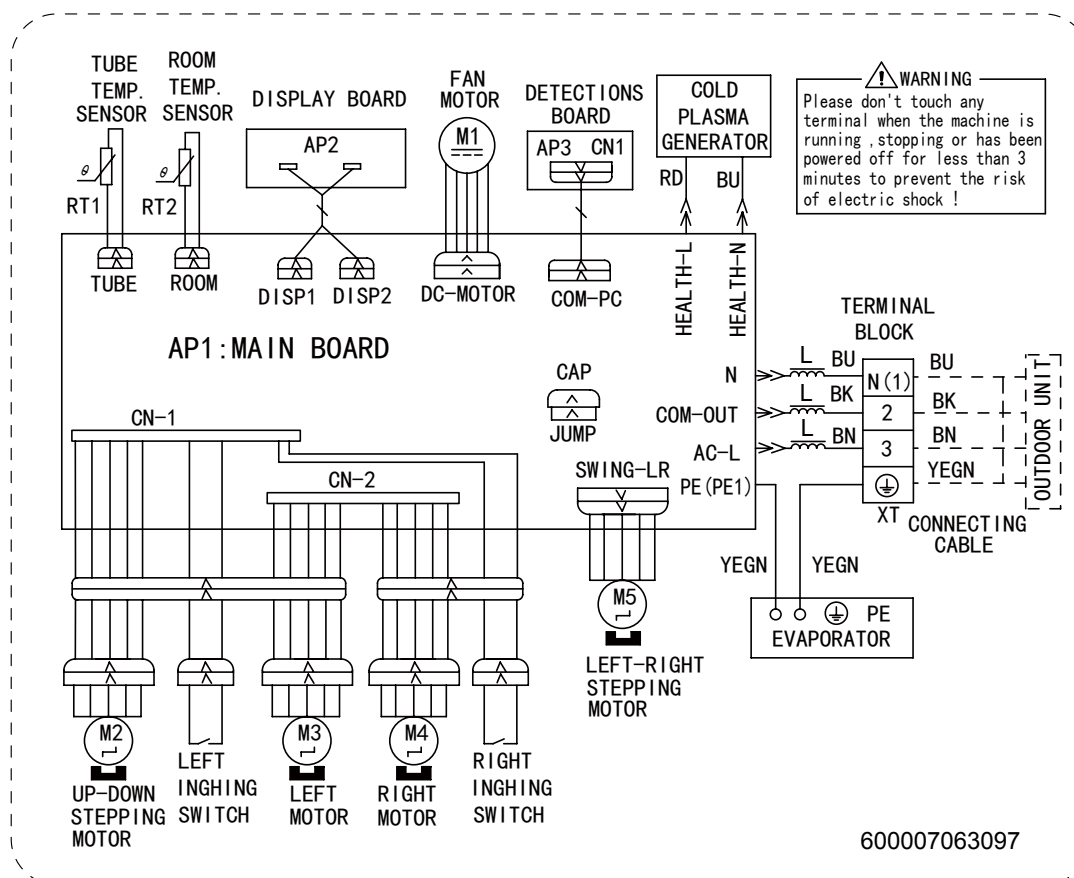





• Outdoor Unit

GWH09UB-K6DNA4A/O GWH12UB-K6DNA4A/O

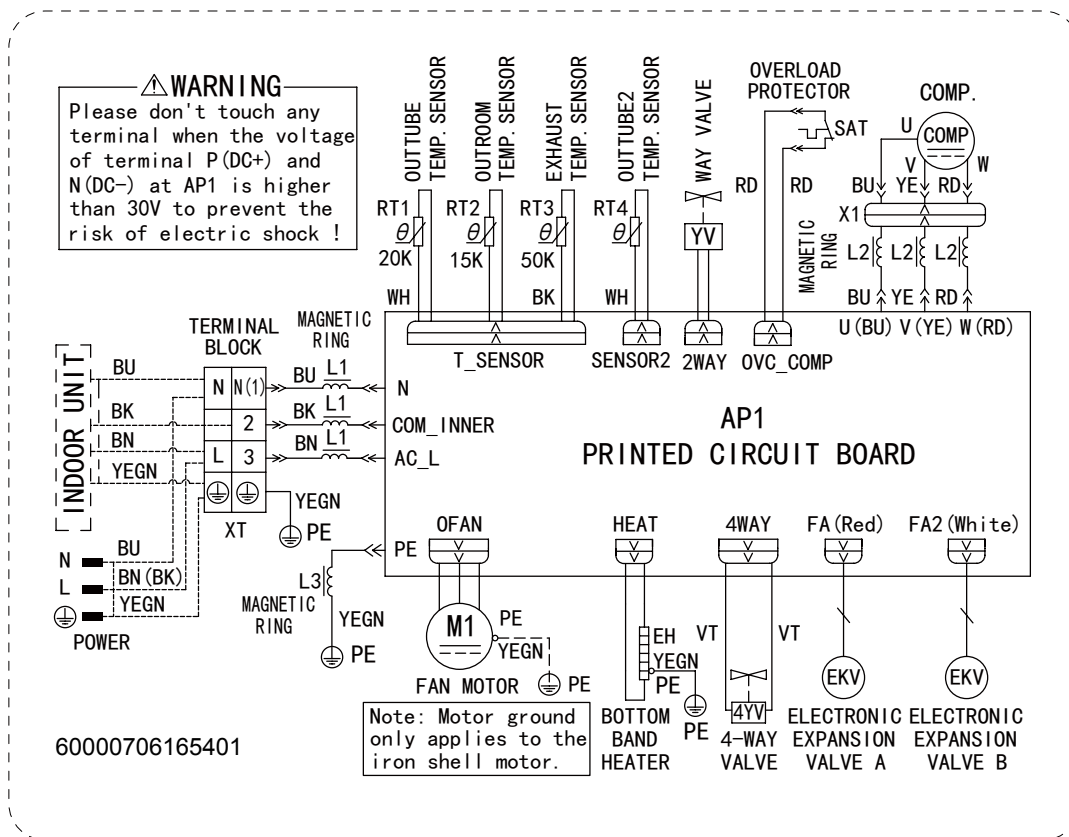

GWH18UC-K6DNA4A/O

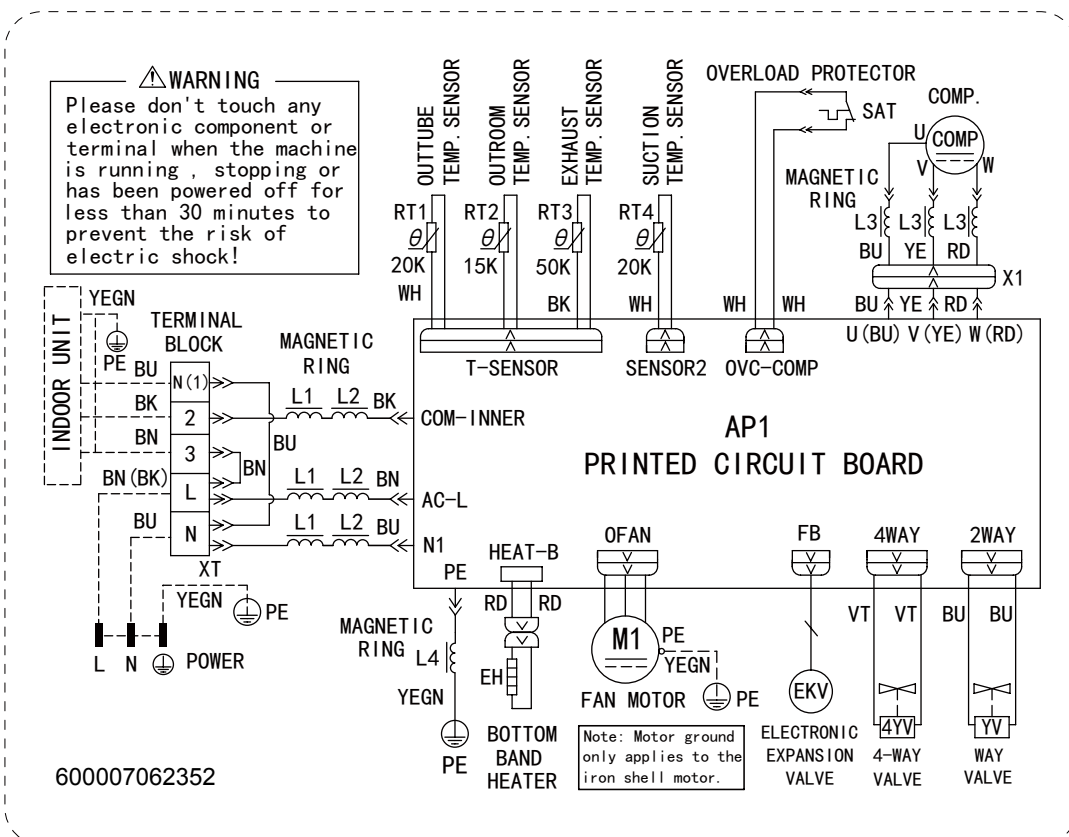

These wiring diagrams are subject to change without notice; please refer to the one supplied with the unit.

### 5.2 PCB Printed Diagram

Indoor Unit

09/12K

• Top view

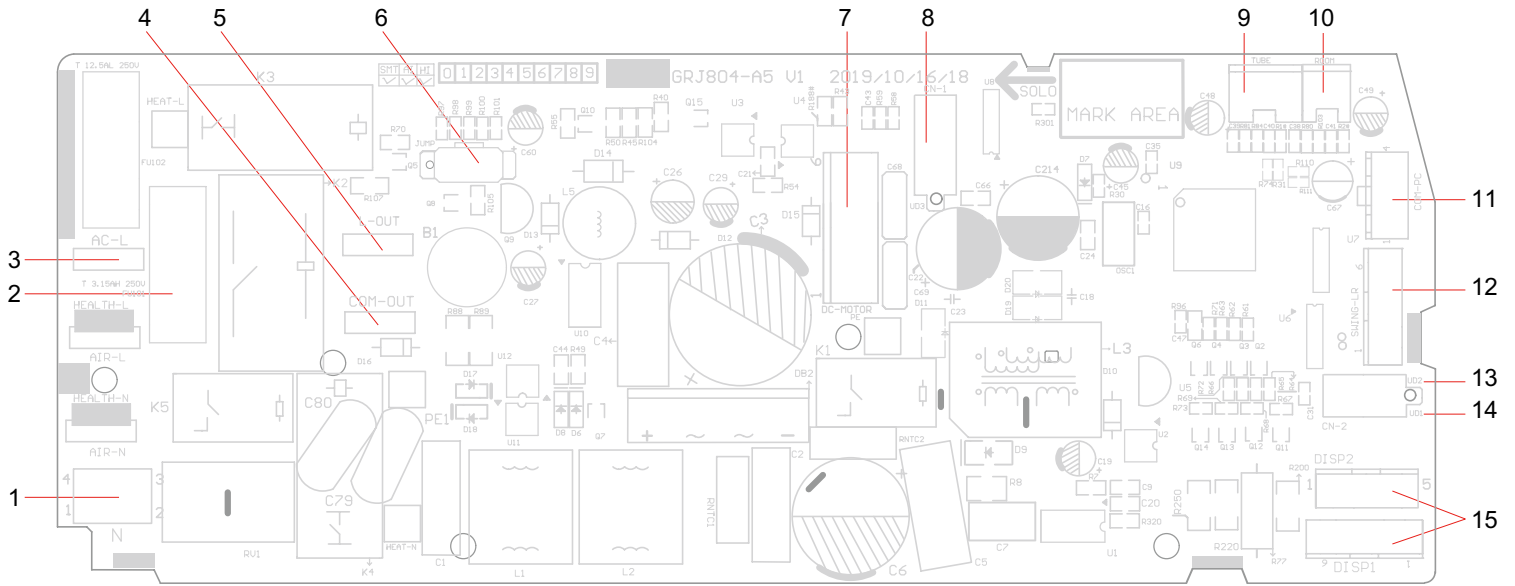

1	Interface of neutral wire	5	Interface of live wire for outdoor unit	9	Tube temperature sensor	13	Up&down swing 2
2	Interface of fuse	6	Interface of jumper cap	10	Ambient temperature sensor	14	Up&down swing 1
3	Interface of live wire	7	Indoor fan motor	11	Communication interface for radio-frequency, WIFI	15	Display interface
4	Interface of communication wire for neutral wire and live wire	8	Up&down swing 3	12	Interface of left&right swing	/	/

• Bottom view

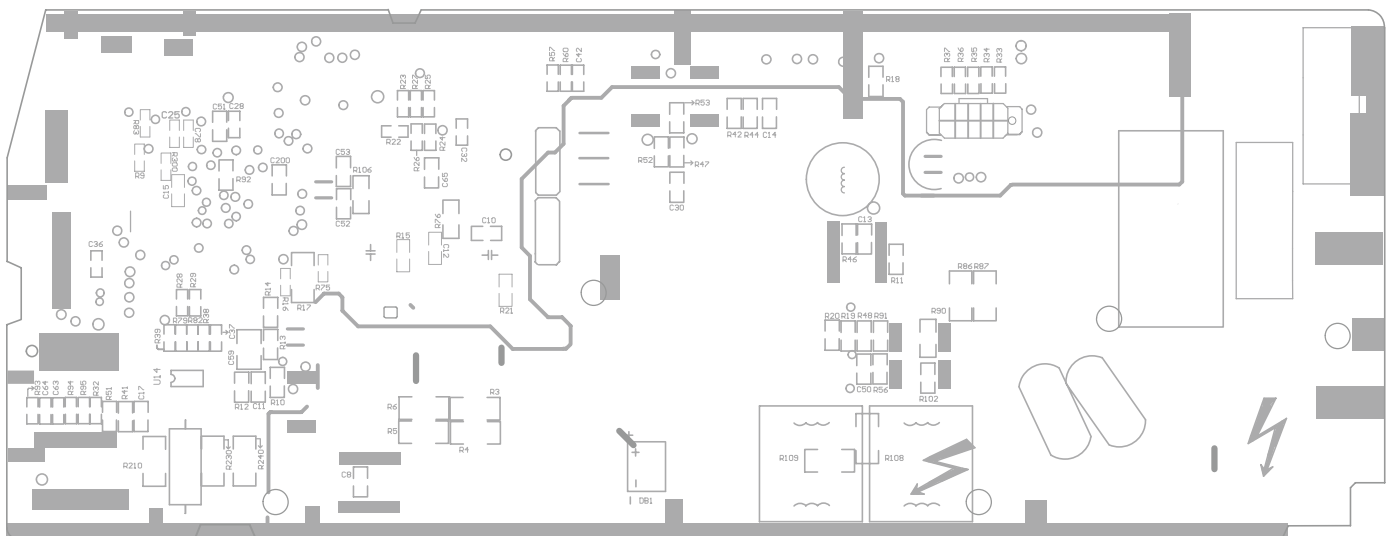

18K

• Top view

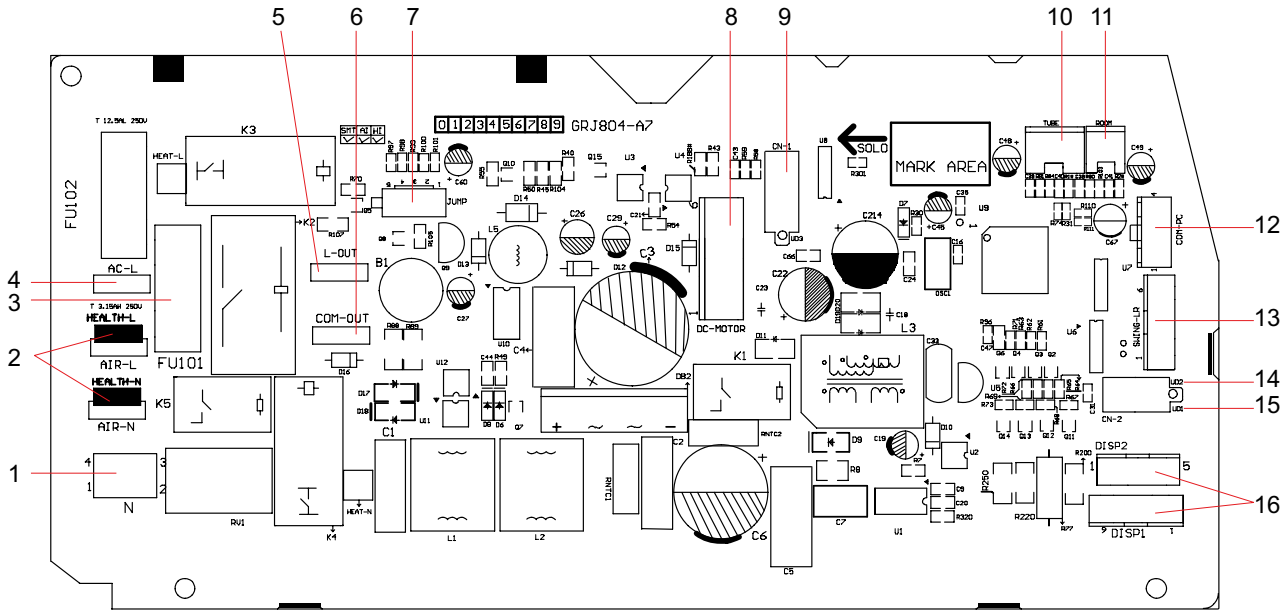

1	Interface of neutral wire	5	Interface of live wire for outdoor unit	9	Up&down swing 3	13	Interface of left&right swing
2	Health interface	6	Interface of communication wire for neutral wire and live wire	10	Tube temperature sensor	14	Up&down swing 2
3	Interface of fuse	7	Interface of jumper cap	11	Ambient temperature sensor	15	Up&down swing 1
4	Interface of live wire	8	Interface of DC motor	12	Communication interface for radio-frequency, WIFI	16	Display interface

• Bottom view

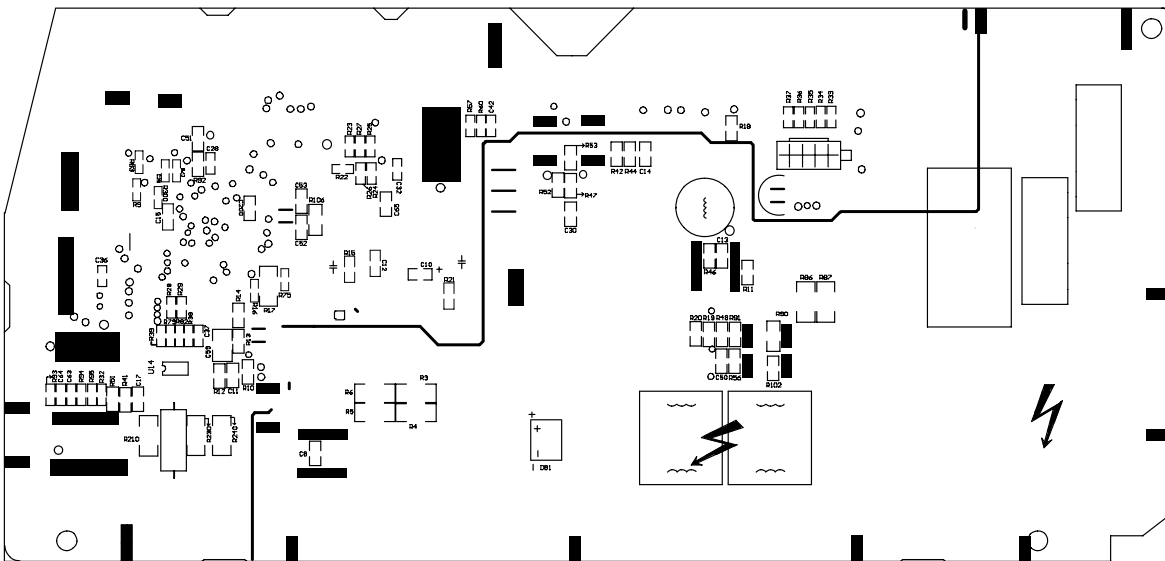

Outdoor Unit  
09/12K

• Top view

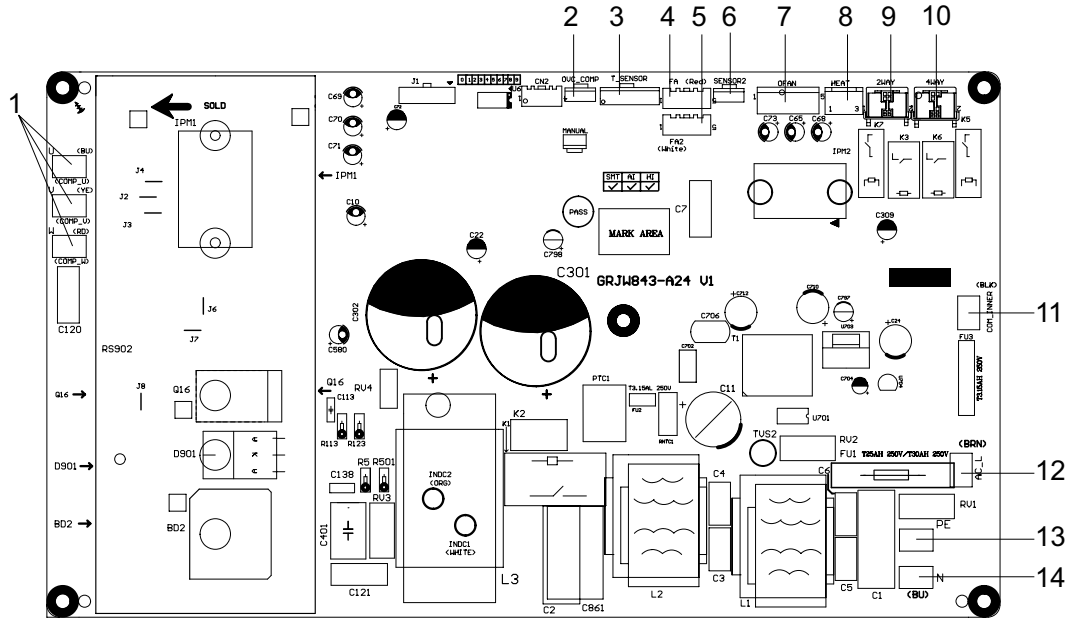

No.	Name
1	Terminal of compressor
2	Overload Terminal of compressor
3	Terminal of temperature sensor
4	Terminal of electronic expansion valve 1
5	Terminal of electronic expansion valve 2
6	Low-temperature cooling sensor
7	Terminal of outdoor fan
8	Terminal of chassis electric heater
9	Terminal of 2-way valve
10	Terminal of 4-way valve
11	Communication wire with indoor unit
12	Live wire terminal
13	Earthing wire terminal
14	Neutral wire terminal

• Bottom view

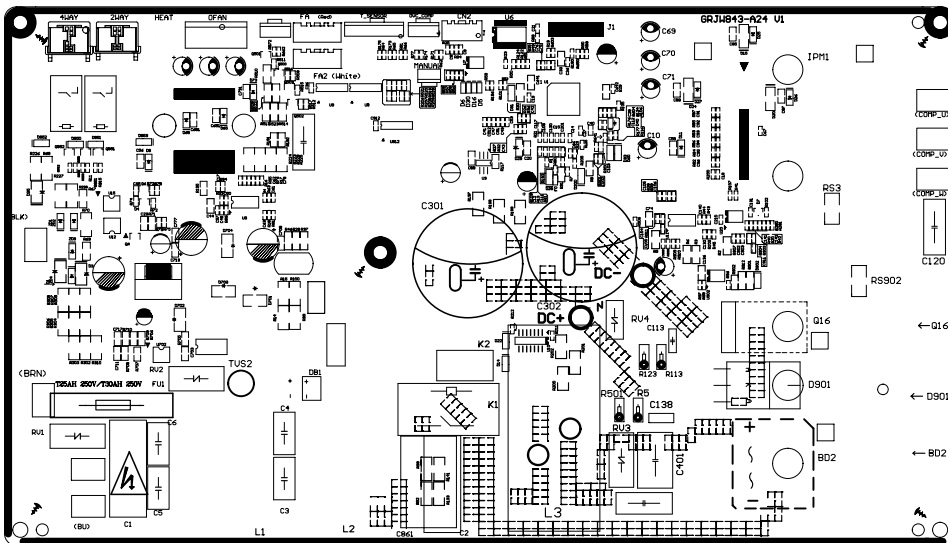

18K

• Top view

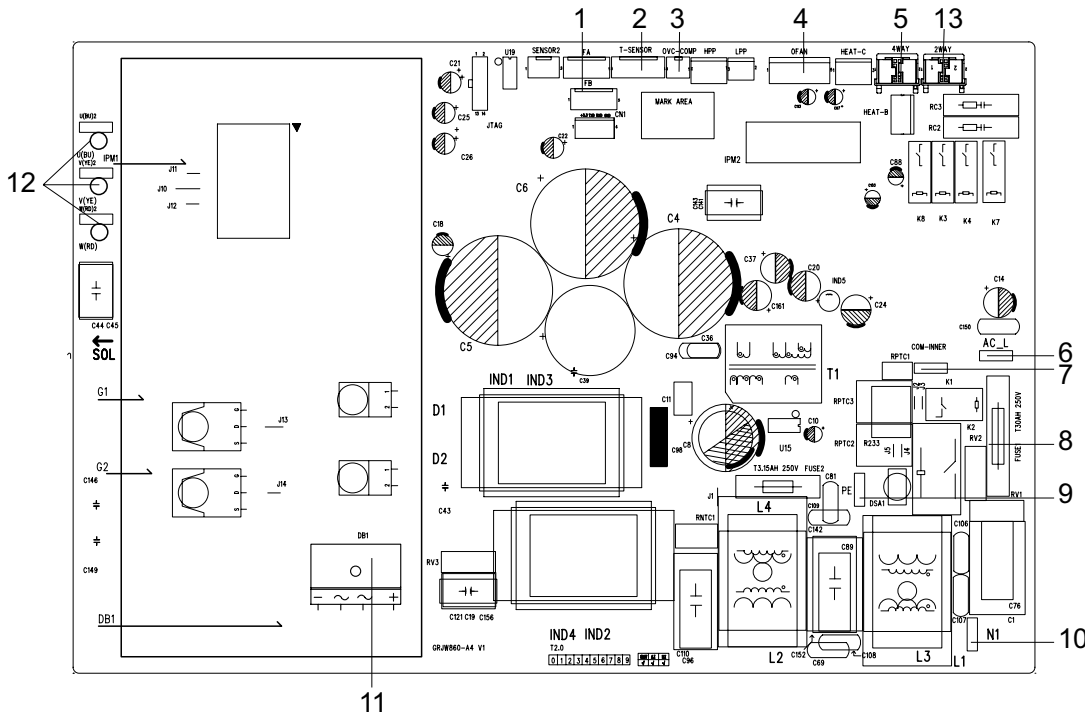

No.	Name
1	Electric Expansion Valve Sub-Assy
2	Temperature Sensor
3	Compressor Overload Protector(External)
4	Terminal of outdoor fan
5	4-way valve terminal
6	Live wire
7	Communication interface
8	Fuse
9	Grounding wire
10	Neutral wire
11	Rectifier
12	Interface of compressor wire
13	Terminal of 2-way valve

• Bottom view

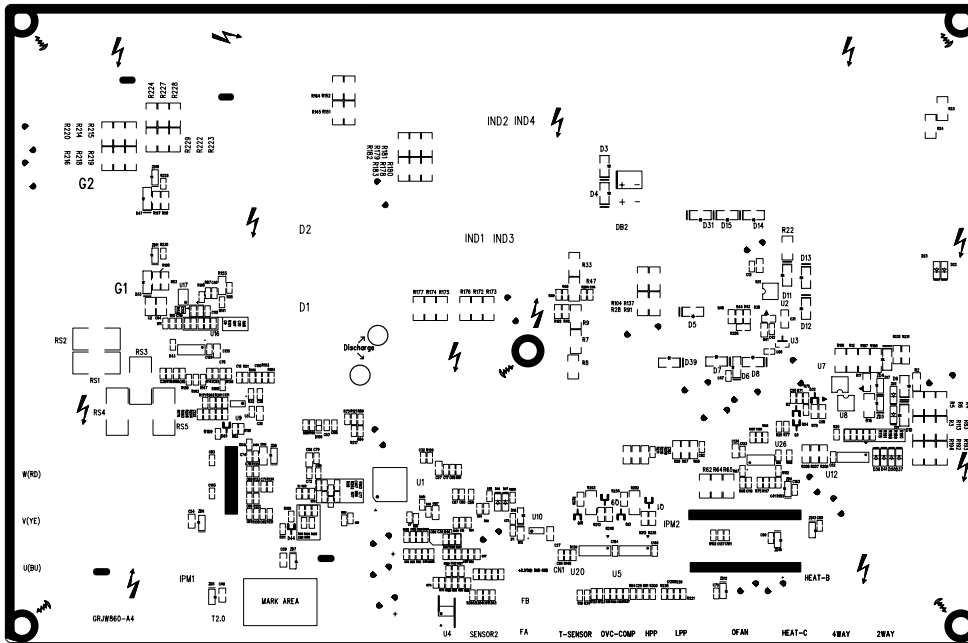

## 6. Function and Control

### 6.1 Remote Controller Introduction

#### Specialties note

##### Matching instructions



This model adopts RF remote control. The remote controller shall be matched with the air conditioner before operation, otherwise the remote control will be invalid. Before operation, please read the instructions in this page carefully and then do the corresponding matching operation.

#### Note:

- Please done the following operation within 6.56ft from the unit. Matching is not needed anymore once it is done.
- During matching, please keep the remote controller and air conditioner under standby status.
- When the signal of remote controller cant be received, please match the remote controller with the unit again.

#### Matching of remote controlle

When the unit is under standby status, please get close to the air conditioner within 6.56ft and then hold on pressing  button for 3s. The remote controller and air conditioner will enter matching automatically. If matching is done, the unit will give out three sounds; if matching is failed, please get closer to the unit and arrange matching again.

#### Buttons on Remote Controller

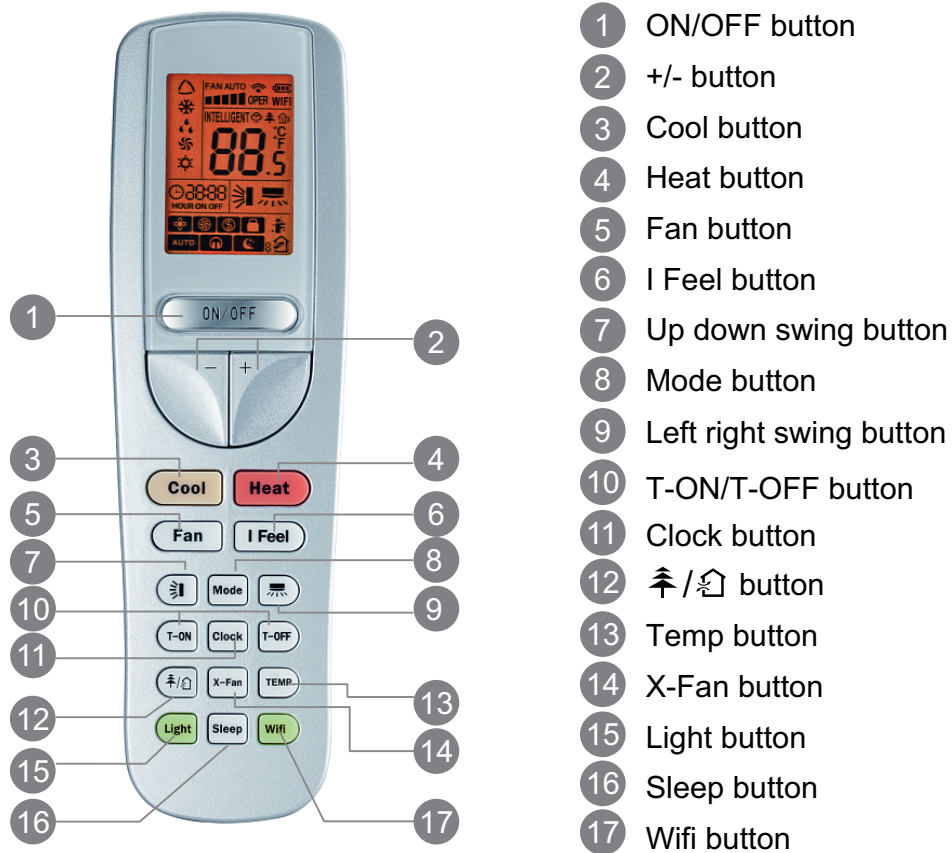

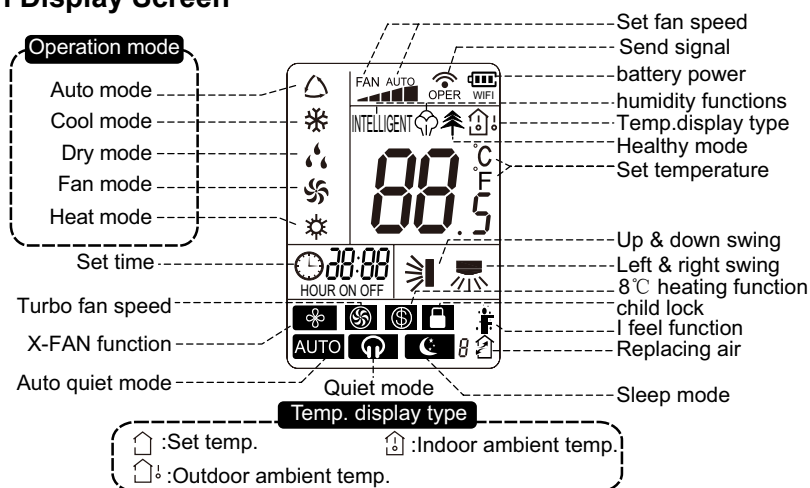

## Introduction for Icons on Display Screen



## Introduction for Buttons on Remote Controller

### Note:

- This is a general use remote controller, it could be used for the air conditioners with multifunction; For some function, which the model don't have, if press the corresponding button on the remote controller that the unit will keep the original running status.
- After putting through the power, the air conditioner will give out a sound. Operation indicator "  " is ON (red indicator the colour is different for different models). After that, you can operate the air conditioner by using remote controller.
- Under on status, pressing the button on the remote controller, the signal icon "  " on the display of remote controller will blink once and the air conditioner will give out a "de" sound, which means the signal has been sent to the air conditioner.

### 1. ON/OFF Button

Press this button can turn on or turn off the air conditioner. After turning on the air conditioner, operation indicator "  " on indoor unit's display is ON (green indicator.

The colour is different for different models), and indoor unit will give out a sound

### 2. +/- button

- Press "+" or "-" button once increase or decrease set temperature 0.5 °C. Holding "+" or "-" button, 2s later, set temperature on remote controller will change quickly. On releasing button after setting is finished, temperature indicator on indoor unit will change accordingly. (Temperature can't be adjusted under auto mode)
- When setting TIMER, press "+" or "-" button to adjust time.







### 3. Cool button

Press this button, unit will operate in cool mode.

### 4. Heat button

Press this button, unit will operate in heat mode.

### 5. FAN button



Pressing this button can set fan speed circularly as: low(  ), low medium(  ), medium(  ), medium high(  ), high(  ), super(  ), auto(AUTO), quiet(  ).



### Note:

- Turbo function is not available under dry and auto mode.
- Automatically operate silent speed when starting sleep function.
- The unit operates at low speed under dry and auto dry mode. The speed can't be adjusted.
- Under AUTO speed, air conditioner will select proper fan speed automatically according to ambient temperature.

### 6. I FEEL button



Press this button to start I FEEL function and "  " will be displayed on the remote controller. After this function is set, the remote controller will send the detected ambient temperature to the controller and the unit will automatically adjust the indoor temperature according to the detected temperature. Press this button again to close I FEEL function and "  " will disappear.

- Please put the remote controller near user when this function is set. Do not put the remote controller near the object of high temperature or low temperature in order to avoid detecting inaccurate ambient temperature.

When I FEEL function is turned on, the remote controller should be put within the area where indoor unit can receive the signal sent by the remote controller.

**7.  button**

Under simple swing mode, press this button can turn on (display "" icon ) or turn off ( not display "" icon) left&right swing function.

Under OFF status, press "+" button and "" button simultaneously can switch between simple swing mode and fixed swing mode. During switching time, "" icon on remote controller will flash twice.

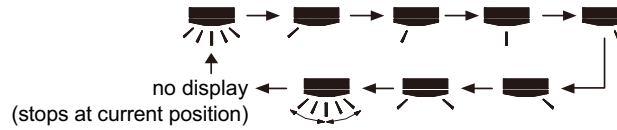

Under fixed-angle swing mode, press this button and the left and right swing status will change in the sequence as below:







**8. MODE button**



Press this button to select your required operation mode.





When selecting auto mode, air conditioner will operate automatically according to ambient temperature. Set temperature cant be adjusted and will not be displayed as well. Press "FAN" button can adjust fan speed. Press "" / "" button can adjust fan blowing angle.

After selecting cool mode, air conditioner will operate under cool mode. Press "+" or "-" button to adjust set temperature. Press "FAN" button to adjust fan speed. Press "" / "" button to adjust fan blowing angle.

When selecting dry mode, the air conditioner operates at low speed under dry mode. Under dry mode, fan speed cant be adjusted. Press "" / "" button to adjust fan blowing angle.

When selecting fan mode, the air conditioner will only blow fan, Press "FAN" button to adjust fan speed. Press "" / "" button to adjust fan blowing angle.



When selecting heating mode, the air conditioner operates under heat mode. Press "+" or "-" button to adjust set temperature. Press "FAN" button to adjust fan speed. Press "" / "" button to adjust fan blowing angle. (Cooling only unit wont receive heating mode signal. If setting heat mode with remote controller, press ON/OFF button cant start up the unit).

**Note:**

- For preventing cold air, after starting up heating mode, indoor unit will delay 1~5 minutes to blow air (actual delay time is depend on indoor ambient temperature).
- Set temperature range from remote controller: 16~30°C (61~86°F);

**9.  button**

Under simple swing mode, press this button can turn on ( display "" icon) or turn off ( not display "" icon) up&down swing function.

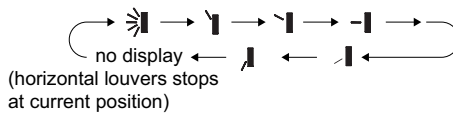

Under OFF status, press "+" button and "" button simultaneously can switch between simple swing mode and fixed swing mode. During switching time, "" icon on remote controller will flash twice.

Under fixed swing mode, press this button and up and down swing status will change in the sequence as below:





**10. T-ON/T-OFF button**

**T-ON button**

"T-ON" button can set the time for timer on. After pressing this button, "" icon disappears and the word "ON" on remote controller blinks. Press "+" or "-" button to adjust T-ON setting. After each pressing "+" or "-" button, T-ON setting will increase or decrease 1min. Hold "+" or "-" button, 2s later, the time will change quickly until reaching your required time. Press "T-ON" to confirm it. The word "ON" will stop blinking. "" icon resumes displaying. Cancel TIMER ON: Under the condition that T-ON is started up, press "T-ON" button to cancel it.

**T-OFF button**

"T-OFF" button can set the time for timer off. After pressing this button, "" icon disappears and the word "OFF" on remote controller blinks. Press "+" or "-" button to adjust T-OFF setting. After each pressing "+" or "-" button, T-OFF setting will increase or decrease 1min. Hold "+" or "-" button, 2s later, the time will change until reaching your required time. Press "T-OFF" to confirm it. The word "ON" will "OFF" will stop blinking. "" icon resumes displaying. Cancel T-OFF. Under the condition that T-OFF is started up, press "T-OFF" button to cancel it.



**Note:**

- Under on and off status, you can set T-OFF or T-ON simultaneously.
- Before setting T-ON or T-OFF, please adjust the clock time.
- After starting up T-ON or T-OFF, set the constant circulating valid. After that, air conditioner will be turned on or turned off according to setting time. ON/OFF button has no effect on setting. If you dont need this function, please use remote controller to cancel it.

**11. CLOCK button**

Press this button to set clock time. "🕒" icon on remote controller will blink. Press "+" or "-" button within 5s to set clock time. Each pressing of "+" or "-" button, clock time will increase or decrease 1 minute. Hold "+" or "-" button, 2s later, time will change quickly. Release this button when reaching your required time. Press "CLOCK" button to confirm the time. "🕒" icon stops blinking.

**Note:**

- Clock time adopts 24-hour mode.
- The interval between two operations cant exceeds 5s. Otherwise, remote controller will quit setting status. Operation for TIMER ON/ TIMER OFF is the same.

**12. 🌿/🏠 button**

Press this button to activate health function with "🌿" displayed; press this button for the second time to activate health and air in function with "🌿" and "🏠" displayed;press this button for the third time to activate health and air out function with "🌿" and "🏠" displayed; press this button for the fourth time to activate air in function with "🏠" displayed; press this button for the fifth time to activate air out function with "🏠" displayed; press this button for the sixth time to exit health, air in or air out function.

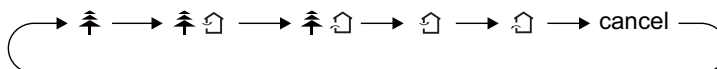

**Note:**there is no this function for this unit. If press this button,the main unit will click, but it also runs under original status.

**13 TEMP button**

By pressing this button, you can see indoor set temperature, indoor ambient temperature or outdoor ambient temperature on indoor units display. The setting on remote controller is selected circularly as below:

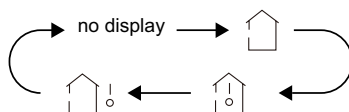

- When selecting "🏠" or no display with remote controller, temperature indicator on indoor unit displays set temperature.
- When selecting:"🏠!" with remote controller, temperature indicator on indoor unit displays indoor ambient temperature.
- When selecting "🏠" with remote controller, temperature indicator on indoor unit displays outdoor ambient temperature.

**Note:**

- Outdoor temperature display is not available for some models. At that time, indoor unit receives "🏠!" signal, while it displays indoor set temperature.
- Its defaulted to display set temperature when turning on the unit. There is no display in the remote controller.
- Only for the models whose indoor unit has dual-8 display.
- When selecting displaying of indoor or outdoor ambient temperature, indoor temperature indicator displays corresponding temperature and automatically turn to display set temperature after three or five seconds.

**14. X-FAN button**

Pressing this button in COOL or DRY mode, the icon "🌀" is displayed and the indoor fan will continue operation for 2 minutes in order to dry the indoor unit even though you have turned off the unit. After energization, X-FAN OFF is defaulted. X-FAN is not available in AUTO, FAN or HEAT mode.

This function indicates that moisture on evaporator of indoor unit will be blown after the unit is stopped to avoid mould.

- Having set X-FAN function on: After turning off the unit by pressing ON/OFF button indoor fan will continue running for about 2 min. at low speed. In this period, press X-FAN button to stop indoor fan directly.
- Having set X-FAN function off: After turning off the unit by pressing ON/OFF button, the complete unit will be off directly.

### 15. LIGHT button

Pressing this button to turn off display light on indoor unit. Press this button again to turn on display light.

### 16. SLEEP button

- Pressing this button can select Sleep 1, Sleep 2, Sleep 3, Sleep 4 or cancel Sleep circularly as below:

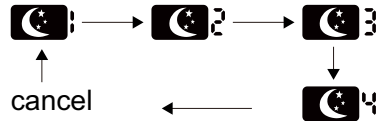

- In Sleep 1 and Sleep 2, the air conditioner will run according to a group of presetting temperature curves.

- Sleep 3 - the sleep curve setting under DIY Sleep mode:

(1) Under Sleep 3 mode, long press "TEMP" button, the remote controller will enter the setting of personalized sleep. In this case, the timer zone of remote controller will display "1 hr" and the set temperature zone "88" will display the corresponding temperature of the last set sleep curve and blink (The first entering will display according to the initial curve setting value of manufacturer);

(2) Press "+" and "-" button to adjust the corresponding temperature. After adjusting, press "TEMP" button to confirm it;

(3) At this time, the timer time on the remote controller will increase automatically by 1hr (that is "2 hr" or "3 hr" ... or "8 hr"). The set temperature zone "88" will display the corresponding temperature of the last set sleep curve and blink;

(4) Repeat step(2) and step (3) until 8-hour temperature setting is finished, then the sleep curve is set successfully. After that, remote controller will resume displaying the original timer time and temperature zone will resume displaying the original set temperature.

- Sleep 3 - the sleep curve inquiry under DIY Sleep mode:

User can inquire the set sleep curve according to the setting method of sleep curve. Enter the setting of personalized sleep but do not change the temperature. Then press "TEMP" button to confirm the setting.

Note: In the above setting or inquiry procedure, if there is no button pressing within 10s, remote controller will automatically exit the sleep curve setting and resume the original display. If ON/OFF, MODE, TIMER, SLEEP, COOLING or HEATING button is pressed during the setting or inquiry procedure, remote controller will also exit the sleep curve setting.

- Sleep 4 is Siesta mode. The set temperature will change automatically according to the features of siesta.

- Sleep function will be disabled if the air condition is restarted after power failure; when sleep function is turned on, quiet fan speed will be also turned on.

- Sleep function can not be set in AUTO mode.

### 17. Wifi button

Press this button 3s can set wifi function on or OFF.

At OFF status, press mode button and wifi button, can reset wifi mode parameter and open wifi function.

If "H1" is displayed on the remote controller while it's not operated by the professional person/after-sales person, it belongs to the misoperation.

Please operate it as below to cancel it. Under the OFF status of remote controller, hold the "MODE" button and "X-FAN" buttons simultaneously for 5s to cancel "H1" display.

Note:

- If remote controller displays "H1", it belongs to the normal function reminder. If the unit is defrosting under heating mode, it operates according to H1 defrosting mode. "H1" won't be displayed on the panel of indoor unit;
- Once you set H1 mode, if you turn off unit by remote controller, H1 will display 3 times on the remote controller and then disappear;
- Also, when you set H1 mode, when you change to heating mode, H1 will display 3 times on the remote controller and then disappear.

### About X-FAN function

This function indicates that moisture on evaporator of indoor unit will be blown after the unit is stopped to avoid mould.

1. Having set X-FAN function on: After turning off the unit by pressing ON/OFF button indoor fan will continue running for about 2 min. at low speed. In this period, press X-FAN button to stop indoor fan directly.

2. Having set X-FAN function off: After turning off the unit by pressing ON/OFF button, the complete unit will be off directly.

### About AUTO RUN

When AUTO RUN mode is selected, the setting temperature will not be displayed on the LCD, the unit will be in accordance with the room temp. automatically to select the suitable running method and to make ambient comfortable.

### About lock

Press + and - buttons simultaneously to lock or unlock the keyboard. If the remote controller is locked, the icon  will be displayed on it, in which case, press any button, the mark will flicker for three times. If the keyboard is unlocked, the mark will disappear.

### About switch between Fahrenheit and Centigrade

Under status of unit off, press MODE and - buttons simultaneously to switch °C and °F.

### Energy-saving function

Under cooling mode, press "TEMP" and "CLOCK" buttons simultaneously to start up or turn off energy-saving function. When energy-saving function is started up, "SE" will be shown on remote controller, and air conditioner will adjust the set temperature automatically according to ex-factory setting to reach to the best energy-saving effect. Press "TEMP" and "CLOCK" buttons simultaneously again to exit energy-saving function.

#### Note:

- Under energy-saving function, fan speed is defaulted at auto speed and it cant be adjusted.
- Under energy-saving function, set temperature cant be adjusted.
- Sleep function and energy-saving function cant operate at the same time. If energy-saving function has been set under cooling mode, press sleep button will cancel energy-saving function. If sleep function has been set under cooling mode, start up the energy-saving function will cancel sleep function.

### 8°C heating function

Under heating mode, press "TEMP" and "CLOCK" buttons simultaneously to start up or turn off 8°C heating function. When this function is started up, "  " and "8°C " will be shown on remote controller, and the air conditioner keep the heating status at 8°C . Press "TEMP" and "CLOCK" buttons simultaneously again to exit 8°C heating function.

#### Note:

- Under 8°C heating function, fan speed is defaulted at auto speed and it cant be adjusted.
- Under 8°C heating function, set temperature cant be adjusted.
- Sleep function and 8°C heating function cant operate at the same time. If 8°C heating function has been set under heating mode, press sleep button will cancel 8°C heating function. If sleep function has been set under heating mode, start up the 8°C heating function will cancel sleep function.
- Under °F temperature display, the remote controller will display 46 °F heating.

## Operation guide

1. After putting through the power, press "ON/OFF" button on remote controller to turn on the air conditioner.
2. Press "MODE" button to select your required mode: AUTO, COOL, DRY, FAN,HEAT.
3. Press "+" or " - " button to set your required temperature. (Temperature cant be adjusted under auto mode).
4. Press "FAN" button to set your required fan speed: auto, low, medium and high speed.
5. Press "  " button to select fan blowing angle.

## Replacement of batteries in remote controller

1. Press the back side of remote controller marked with "  " as shown in the fig, and then push out the cover of battery box along the arrow direction.
2. Replace two 7# (AAA 1.5V) dry batteries, and make sure the position of "+" polar and "-" polar are correct.
3. Reinstall the cover of battery box.

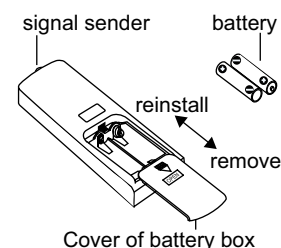

Battery level will be displayed on the remote controller. When "  " is flickering, please replace the batteries, otherwise, remote controller cant operate normally.

#### Note:

- During operation, point the remote control signal sender at the receiving window on indoor unit.
- The distance between signal sender and receiving window should be no more than 26.25ft , and there should be no obstacles between them.
- Signal may be interfered easily in the room where there is fluorescent lamp or wireless telephone; remote controller should be close to indoor unit during operation.
- Replace new batteries of the same model when replacement is required.
- When you dont use remote controller for a long time, please take out the batteries.
- If the display on remote controller is fuzzy or theres no display, please replace batteries.



## 6.2 GREE+ App Operation Manual

### Control Flow Chart

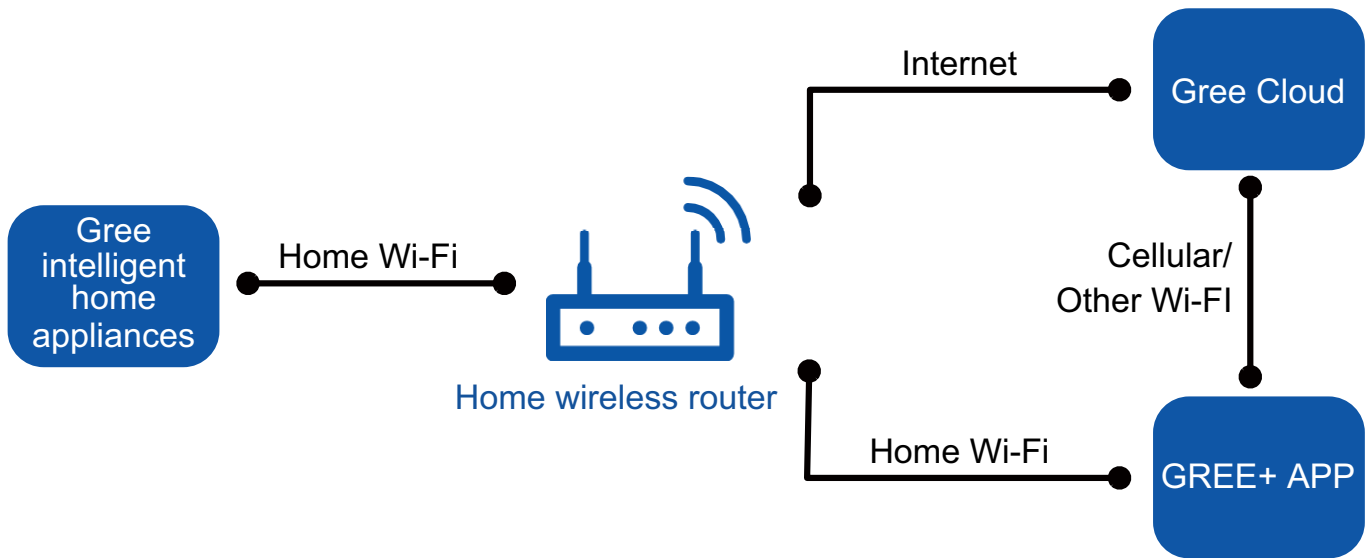

### Operating Systems

Requirement for Users smart phone:



iOS system  
Support iOS7.0 and  
above version



Android system  
Support Android 4.4 and  
above version

### Download and installation



GREE+ App Download Linkage

Scan the QR code or search "GREE+" in the application market to download and install it. When "GREE+" App is installed, register the account and add the device to achieve long-distance control and LAN control of Gree smart home appliances. For more information, please refer to "Help" in App.

## 6.3 Ewpe Smart App Operation Manual

### Control Flow Chart

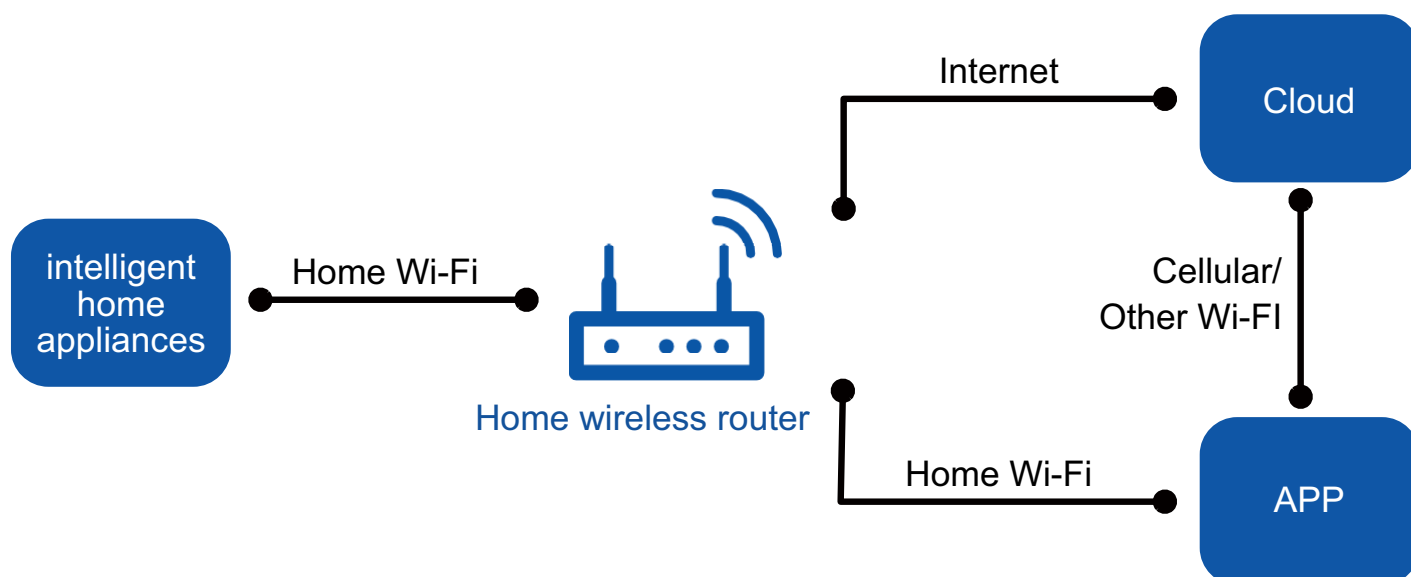

### Operating Systems

Requirement for Users smart phone:



iOS system  
Support iOS7.0 and  
above version



Android system  
Support Android 4.4 and  
above version

### Download and installation



App Download Linkage

Scan the QR code or search "Ewpe Smart" in the application market to download and install it. When "Ewpe Smart" App is installed, register the account and add the device to achieve long-distance control and LAN control of smart home appliances.

For more information, please refer to "Help" in App.

## 6.4 Brief Description of Modes and Functions

Conversion formula for Fahrenheit degree and Celsius degree:  $T_f = T_c \times 1.8 + 32$

### Indoor unit

#### 1. This controller includes functions as below

(1) Auto; (2) Cooling; (3) Dry; (4) Fan; (5) Heating

#### 2. Control object of controller

(1) Indoor unit :

Cooling mode: seven kinds of fan speed in total (including quiet, fan 1, fan 2, fan 3, fan 4, fan 5, turbo).

Heating mode: five kinds of fan speed in total (including quiet, fan 1, fan 2, fan 3, fan 4, fan 5, turbo).

Fan mode: Fan speed is same as that under cooling mode.

Dry mode: Low fan and quiet can be set under this mode. The fan speed is same as that for low fan under cooling mode.

Auto mode: Turbo is not available for this mode and the fan speed is same as that under each operation mode (cooling mode, fan mode, heating mode).

(2) Stepping motor for up&down swing.

(3) Stepping motor for swing mechanism.

(4) Stepping motor for left&right swing.

(5) E-heater.

(6) Health function (cold plasma reserved).

(7) Normal buzzer.

#### 3. Basic functions of system

##### (1) Cooling mode

① Operation condition and process for cooling mode ( refer to outdoor unit instruction for inverter unit).

② Protection function ( refer to outdoor unit instruction for inverter unit).

##### (2) Dry mode

① Operation condition and process for dry mode.

② Protection function ( refer to outdoor unit instruction for inverter unit).

##### (3) Heating mode (not for cooling only unit)

① Operation condition and process for heating mode.

② Defrosting condition and process (refer to outdoor unit instruction for inverter unit): As for normal intelligent defrosting; the unit will defrost automatically according to frosting condition and operation indicator will be on 10s and off 0.5s circularly. As for non-stop defrosting, the indoor fan will be started up according to the frosting condition and the operation indicator will be on 10s and off 0.5s circularly.

③ Protection function (refer to outdoor unit instruction for inverter unit).

##### (4) Fan mode

Under this mode, indoor fan operates at set fan speed. Compressor, outdoor fan, 4-way valve and electric heating tube all stop operation. Under this mode, the temperature setting range is 16~30°C . Operation icon and set temperature is displayed.

##### (5) Auto mode

Under auto mode, the system will select the operation mode (cooling, heating, fan) according to the change of ambient temperature. Operation icon, actual operation mode icon and set temperature will be displayed. There's 30s time delay for protection for mode switchover. Protection function is same as that under each mode.

#### 4. Display status of indoor indicator

##### (1) Display status of indoor unit

① After energization, all display icons will be displayed and then only the power indicator is on. When turning on the unit with remote controller, the operation indicator is on and the current set operation mode will be displayed.

② During defrosting, the operation indicator will be on 10s and off 0.5s circularly. Under auto mode, the dual-8 nixie tube displays 25 under cooling mode or fan mode, and 20 under heating mode. Mode indicator is displayed according to the mode.

③ Dual-8 nixie tube displays set temperature.

##### (2) Error indicator display on indoor unit

Display table for error status		
Error name	Error definition	Dual-8 code display
Freon recovery mode	Operation status is displayed immediately	Fo
Malfunction of indoor fan	Malfunction of hardware	H6
Malfunction of middle temperature sensor of indoor evaporator	Malfunction of hardware	F2
Malfunction of indoor ambient temperature sensor	Malfunction of hardware	F1
Communication malfunction between indoor unit and outdoor unit	Malfunction of hardware	E6
Malfunction of jumper cap	Malfunction of hardware	C5
Limit/decrease frequency due to module current protection	Display through adjustment with remote controller	En
Limit/decrease frequency due to module temperature protection	Display through adjustment with remote controller	EU
Limit/decrease frequency due to overload protection	Display through adjustment with remote controller	F6
Limit/decrease frequency due to freeze prevention protection	Display through adjustment with remote controller	FH
Limit/decrease frequency due to discharge protection	Display through adjustment with remote controller	F9
Limit/decrease frequency due to AC current protection of outdoor unit	Display through adjustment with remote controller	F8
Malfunction overload temperature sensor	Malfunction of hardware	FE
Malfunction of outdoor discharge temperature	Malfunction of hardware	F5
Malfunction of outdoor ambient temperature sensor	Malfunction of hardware	F3
Malfunction of outdoor condenser temperature sensor	Malfunction of hardware	F4
Circuit malfunction of module temperature sensor	Malfunction of hardware	P7
Overload protection of compressor	Other malfunction	H3
Discharge protection	Other malfunction	E4
Overload protection	Other malfunction	E8
AC current protection of outdoor unit	Other malfunction	E5
Module current protection	Other malfunction	H5
Module temperature protection	Other malfunction	P8
Freeze prevention protection	Other malfunction	E2
High power protection	Other malfunction	L9
Lacking/inverse phase protection of compressor	Other malfunction	U2
PFC current malfunction	Other malfunction	HC
High DC bus bar voltage protection	Other malfunction	PH
Low DC bus bar voltage protection	Other malfunction	PL
Freon-lacking protection	Other malfunction	F0
Mode shock	Malfunction of hardware	E7
Non-matching between indoor unit and outdoor unit	Malfunction of hardware	LP
Read-write malfunction of memory chip	Malfunction of hardware	EE
Abnormal changeover for 4-way valve	Malfunction of hardware	U7
Malfunction of outdoor fan 2	Malfunction of hardware	LA
Malfunction of outdoor fan 1	Malfunction of hardware	L3
Low pressure protection	Other malfunction	E3
High pressure protection	Other malfunction	E1
Drop malfunction of DC bus bar voltage	Other malfunction	U3
Current detection malfunction for the complete unit	Malfunction of hardware	U5
Charging malfunction for capacity	Malfunction of hardware	PU
Phase current detection malfunction of compressor	Malfunction of hardware	U1
Desynchronizing of compressor	Other malfunction	H7
Demagnetizing protection of compressor	Other malfunction	HE
Failure startup of compressor	Other malfunction	Lc
High peak current of compressor	Other malfunction	P5
Conglutination malfunction of relay of refrigerant electric heater of outdoor unit	Malfunction of hardware	A2
Refrigerator heater of outdoor unit is invalid	Display through adjustment with remote controller	A3
Malfunction of temperature sensor of refrigerant heater	Malfunction of hardware	A4
Malfunction exit tube temperature sensor for condenser	Malfunction of hardware	A5
Oil return	Display through adjustment with remote controller	F7
Normal cooling and heating (capacity test code)	Operation status is displayed immediately	P1
Maximum cooling and heating (capacity test code)	Operation status is displayed immediately	P2
Medium cooling and heating (capacity test code)	Operation status is displayed immediately	P3
Minimum cooling and heating (capacity test code)	Operation status is displayed immediately	P0

## 5. Other control

### (1) Timer function

Timer ON: Timer ON can be set under off status. After time is over, the unit will operate at original setting mode. The timer interval is 0.5h and the timer setting range is 05~24h.

Timer OFF: Timer OFF can be set under on status. After time is over, the unit will be turned off. The timer interval is 0.5h and the timer setting range is 05~24h.

### (2) Auto button

Press this button and the unit will operate at auto mode. Indoor fan operates at auto fan speed and the swing motor operates. Press this button again to turn off the unit.

### (3) Buzzer

Upon energization or available operating the unit or remote controller, the buzzer will give out a beep.

### (4) Sleep function

In SLEEP mode, the unit will automatically select appropriate sleep curve to operate according to different temperature setting.

### (5) Turbo Function

This function can be set in cooling or heating mode.

### (6) X-fan function

X-fan function can be set in cooling or drying mode.

### (7) Compulsory defrosting function

① turn on compulsory defrosting function

Under on status, set heating mode with remote controller and adjust the temperature at 16°C. When pressing “+, -, +, -, +, -” button successively within 5s and the complete unit will enter into compulsory defrosting status. Meanwhile, operation indicator on indoor unit is on 10s and off 0.5s circularly. (Note: If the complete has malfunction or stops operation due to protection, compulsory defrosting function can be started up only after malfunction or protection is resumed.)

② Exit compulsory defrosting mode

After compulsory defrosting is started up, the complete unit will exit defrosting according to actual defrosting result automatically. The complete unit will resume heating operation normally.

### (8) Refrigerant recovery function (applicable for movement or maintenance)

① Start up refrigerant recovery function

Within 5min after energization (on or off status), set cooling mode with remote controller and adjust the temperature at 16°C. When pressing light button on remote controller to any one indoor unit for 3 times within 3s, the complete unit will enter into refrigerant recovery status after setting is succeeded and all indoor unit displayed F0. After that, maintenance staff turns off all liquid valves.

5min later, hold all thimbles at service valves in turn with tools. If there's no refrigerant spurting out, turn off corresponding gas valve immediately, turn off the unit with remote controller and then you can disassemble the connection pipe.

② Quit refrigerant recovery function

During refrigerant recovery process, if any one indoor unit receives any remote control signal or refrigerant recovery function has operated for 25min, the unit will exit refrigerant recovery function. If the complete unit is at standby status before refrigerant recovery, the unit is still at standby status after refrigerant recovery. If the complete unit is at operation status before refrigerant recovery, the unit will operate at original operation mode after refrigerant recovery.

③ After entering refrigerant recovery function

Indoor unit operates at cooling mode. Fan speed is super high fan speed and the set temperature is 16°C. The horizontal louver will stay at the minimum operation angle.

### (9) Auto fan speed control

Under this mode, indoor fan will select high, high-medium, medium, medium-low or low fan speed according to ambient temperature sensor.

### (10) Left&right swing control

Select different left&right swing direction according to remote control status of left&right swing.

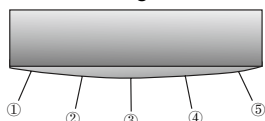

### (11) Up&down swing control

Up&down swing is composed of swing mechanism and swing blade;

After energization, the swing mechanism will perform reset action. The horizontal louver will open to the maximum angle and then be closed;

After turning on the unit, the swing mechanism will extend different length according to remote control status. By view of the position



of swing blade, there are upper swing and lower swing.

When selecting fixed-angle swing, you can select 5 kinds of swing position for blowing fan;

After selecting free swing, lower swing for heating mode and upper swing for cooling mode.

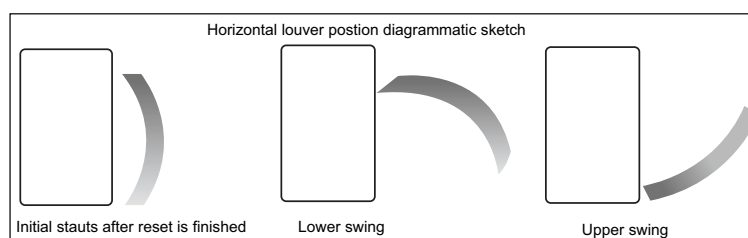

## (12) Display

### ① Display of operation icon and mode icon

After energization, all icon will be displayed for once. Under standby status, operation icon will be in white. After turning on the unit with remote controller, the icon for the current operation mode will be displayed (mode: cooling, heating, 0.5, defrosting, frequency visual). After pressing light button to turn off light, all displays will be turned off. When turning on the unit, the backlight indicator will be turned on; when turning off the unit or light button, backlight indicator won't be turned on.

### ② Dual-8 nixie tube display

When turning on the unit after energization for the first time, the nixie tube is defaulted to display current set temperature (the temperature setting range is 16~30°C). When it received the signal of display set temperature, the nixie tube displays set temperature; when it received the signal of display ambient temperature, the nixie tube will display current indoor ambient temperature; if remote control to set other status, the display won't change. F1 will be displayed for the malfunction of ambient temperature sensor; F2 will be displayed for the malfunction of indoor tube temperature sensor; C5 will be displayed for the malfunction of jumper cap.

## (13) Locked protection to motor

After turning on the fan, when the motor operates at low speed for a period of time, it will stop operation for preventing auto protection of motor and lockage will be displayed. If it's at on status, dual-8 nixie tube displays lockage error code H6; if it's at off status, lockage information won't be displayed.

## 6. Special Functions

### (1) Rf control function

There are three optional mode—air, humidify and air purifier. After matching is succeeded, you can control the related mode through remote controller.

### (2) I Feel function

When I FEEL command is received, the controller will operate according to the ambient temperature sent by the remote controller (For defrosting and cold blow prevention, the unit operates according to the ambient temperature sensed by the air conditioner). The remote controller will regularly send ambient temperature data to the controller. When the data has not been received for a long time, the unit will operate according to the temperature sensed by the air conditioner. If I FEEL function is not selected, the ambient temperature will be that sensed by the air conditioner. I FEEL function is not to be memorized.

### (3) Malfunction detecting of temperature sensor

When it detected that there's malfunction of indoor ambient temperature sensor, it will display F1; when it detected that there's malfunction of indoor tube temperature sensor, it will display F2.

### (4) Low power consumption standby function

When the air conditioner is in power off and at standby status, it will enter into low power consumption standby status 6 minutes later, and the operation indicator will be turned off.

## 7. Error Analysis

### (1) Error 1: No response after energization, and buzzer does not give out a beep.

Solution: Please check the power supply or replace the controller.

### (2) Error 2: Dual-8 nixie tube of display board displays "C5".

Solution: The jumper cap has not been firmly connected to the controller, please reinsert or replace the jumper cap with the same specification.

### (3) Error 3: Dual-8 nixie tube of display board displays "F1".

Solution: The ambient temperature sensor of air conditioner has not been firmly connected to the controller, please reinsert or replace an ambient temperature sensor.

### (4) Error 4: Dual-8 nixie tube of display board displays "F2".

Solution: The tube temperature sensor of air conditioner has not been firmly connected to the controller, please reinsert or replace a tube temperature sensor.

**(5)Error 5: Dual-8 nixie tube of display board displays “H6”.**

Solution: The feedback wire of indoor fan has not been firmly connected to the controller or the indoor fan motor fails to work, please reinsert the feedback line of indoor fan or replace the main board of controller, or replace the motor.

**(6)Error 6: Dul-8 nixie tube of display board displays “FC”.**

Solution: It is malfunction of swing mechanism, which is caused by the looseness of connecting wire or damage of swing mechanism or main board. Please reconnect the connecting wire, or replace the swing mechanism or controller.

**(7)Error 7: Dul-8 nixie tube of display board displays “JF” or “rF”.**

Solution: It is abnormal of detecting board, which is caused by the looseness of communication line between the main board and detecting board, or the malfunction of detecting board or main board. Please reinsert the connecting wire, or replace the detecting board or controller.

**8.Blockage protection to Motor**

- (1) When turning on the fan, the motor speed is not more than 300rpm/min for 1 min consecutively, its blockage protection to motor.
- (2)During lockage protection to motor, all load stop operation (indoor fan, outdoor fan, compressor, and electric heating tube stop operation; 4-way valve should delay 2mins to stop operation and then horizontal louver will stop at the current position.
- (3)Once theres blockage protection to motor, cut off the power to resume operation.
- (4)During blockage protection to motor, remote controller and buttons are valid and they can turn on or turn off the unit, while they wont perform detailed target (indoor fan, outdoor fan, compressor, and electric heating tube stop operation, and 4-way valve should delay 3mins to stop operation; horizontal louver will stop at current position).
- (5)During motor blockage protection, if the unit is at on status, the dual-8 nixie tube displayed blockage error code H6; if the unit is at off status, it wont display blockage malfunction information.

**9.Communication malfunction**

If the unit hasnt received correct signal for 3mins consecutively, its the communication malfunction. Outdoor fan stop operation and stop operation after blowing residual heat under auto heating mode or heating mode. Indoor fan operated at set fan speed under other modes.

**10.Auto inspection function**

Maflunction of jumer cap

After energization, when its detected the jumper cap outlet is blank, its the malfunction of jumper cap, which cant resumed. During malfunction protection of jumper cap, if the unit is at on status, the nixie tube displays error code: “C5” and operation indicator is blinking. If the unit is at off status, it wont display error code.

Note: The controller without this function wont detection this malfunction.

## Outdoor unit

### 1. System function

#### 1.1 Cooling mode

##### 1.1.1 Working condition and process for cooling

When the compressor is at off status, turn on the unit under cooling mode. When indoor unit reaches the condition of turning on the unit, the unit operates under cooling mode. Meanwhile, indoor fan, outdoor fan and compressor stops operation.

##### 1.1.2 Stop operation under cooling mode

Compressor stopped operation, compressor stops operation immediately and outdoor fan delay 30s to stop operation.

##### 1.1.3 Switch to heating mode from cooling mode

When switching to heating mode, 4-way will delay 3min to be energized after compressor is stopped. Others are same with that stopped operation under cooling mode.

##### 1.1.4 4-way valve: 4-way valve will be closed under this mode

##### 1.1.5 Outdoor fan control under cooling mode

After compressor stops operation, outdoor fan will operate at current fan speed for another 30s and then stops operation.

#### 1.2 Drying mode

##### 1.2.1 Working condition and process for drying mode: same with that for cooling mode

##### 1.2.2 Status of 4-way valve: OFF.

##### 1.2.3 Temperature setting range: 16~30°C.

##### 1.2.4 Protection function: Same with that under cooling mode.

##### 1.2.5 The startup condition for electronic expansion valve, outdoor fan and compressor is same as that for cooling mode.

#### 1.3 Heating mode

##### 1.3.1 Working condition and process for heating mode

When indoor unit reaches the startup condition of heating, indoor unit will operate under heating mode.

##### 1.3.2 Stop operation under heating mode:

a. When indoor unit reached OFF or stop operation conditioner, compressor stop operation, and outdoor fan will delay 1min to stop operation.

##### b. Switch to cooling(drying) or fan mode

(a) compressor stops operation; (b) 4-way valve will delay 2min to be de-energized;

(c) outdoor fan will delayed 30s to stop operation; (d) status of 4-wayvalve: energized.

##### 1.3.3 Outdoor fan control under heating mode

When compressor stops operation, outdoor fan will delay 30s to stop operation.

##### 1.3.4 Defrosting function

When it satisfied defrosting condition, compressor stops operation. After compressor stopped for 30s, outdoor fan stops operation and 4-way valve will change direction; After 4-way valve chaging direction, compressor will be startup, defrosting will start counting time and compressor frquency will be increased to defrosting frequency.

#### 1.4 Fan mode

##### 1.4.1 Compressor, outdoor fan and 4-way valve will all be stopped or closed.

##### 1.4.2 Temperature setting range is 16~30°C.

### 2. Protection function

#### 2.1 Overload protection function

During cooling mode, measure the temperature of outdoor heat exchanger; during heating mode, measure the temperature of indoor heat exchanger.

(1)When  $T_{tube} \leq T_1$ , resume original operation status;

(2)When  $T_{tube} \geq T_2$ , prohibit increasing frequency;

(3)When  $T_{tube} \geq T_3$ , compressor will decrease frequency to operate.

(4)When  $T_{tube} \geq T_4$ , compressor stops operation;

During cooling or drying mode:  $T_1=52$ ;  $T_2=55$ ;  $T_3=58$ ;  $T_4=62$ ;

During heating mode:  $T_1=50$ ;  $T_2=53$ ;  $T_3=56$ ;  $T_4=60$ ;

Under auto heating or heating mode, indoor unit will stop operation after blow residual heat. Under other modes, indoor fan operates at set fan speed.

2.2 Delay protection of compressor

When compressor is stopped, it needs 3min to restart up the compressor. Once compressor is started up, compressor wont stop operate within 6in according to the change of temperature.

2.3 Discharge temperature protection of compressor

- (1)When TBdischarge  $B \geq 98^{\circ}\text{C}$ , prohibit increasing frequency;
- (2)When TBdischarge  $B \geq 103^{\circ}\text{C}$ , prohibit decreasing frequency;
- (3)When TBdischarge  $B \geq 110^{\circ}\text{C}$ , compressor stops operation;
- (4)When TBdischarge  $B \leq 90^{\circ}\text{C}$ , protection is released.

2.4 Communication malfunction

When the unit hasnt received correct signal for 3mins consecutively, its the communication malfunction. The complete unit will stop operation.

2.5 Module protection

During module protection, compressor stops operation. When compressor has stopped operation for 3min, compressor will resume operation. When module protection occurs all the time when starting up compressor for 6 times consecutively, compressor cant be started any more (turn off the unit with remote controller can clear up module, and the accumulative times of module protection).

When the operation time of compressor is more than 6mins, the accumulative times will be cleared up.

2.6 When DC bus voltage is lower than 150V or more than 420V, compressor will delay 30s to stop operation. When DC bus voltage is more than 200C and less than 400V, protection will be resumed. Compressor will resume operation after it has stopped for 3mins. During low pressure protection, main relay will break off. When low voltage protection is resumed, main relay will be closed.

2.7 When overload malfunction is occurred, compressor stopped operation and outdoor fan will delay 30s to stop operation; when malfunction is cleared up and compressor has stopped for 3min, the unit will resume operation.

2.8 Power protection of compressor

- (1)When PCB $\geq 1500\text{w}$ , prohibit increasing frequency;
- (2)When PCB $\geq 1600\text{w}$ , decrease frequency to operate;
- (3)When PCB $\geq 1700\text{w}$ , compressor stops operation;
- (4)When PCB $\leq 1400\text{w}$ , protection is released.

2.9 Malfunction of temperature sensor

Name of temperature sensor	Malfunction condition
Outdoor ambient	Its detected that the temperature sensor is open/short-circuited for 5s consecutively
Outdoor tube temperature	Its detected that the temperature sensor is open/short-circuited for 5s consecutively; it wont be detected within 10mins after defrosting
Air discharge	After compressor operates for 3min,its detected that the temperature sensor is open/short-circuited for 5s consecutively

2.10 When outdoor fan is open-circuited or current is more than 0.8aA, outdoor fan will stop operation and then be restarted up 4s later. If the fan stops operation for 6 times successively, its the malfunction of fan. And then compressor will stops operation. 3mins later, the malfunction of fan will be cleared and restart up outdoor fan and compressor. If malfunction of fan occurs for 6 times successively, outdoor fan wont be restarted up. Turn off the unit with remote controller can clear up malfunction and the accumulated timer of malfunction. After compressor operates for 6mins successively, the accumulated malfunction times of fan will be cleared.

# Part II : Installation and Maintenance

## 7. Notes for Installation and Maintenance

### Safety Precautions: Important!

Please read the safety precautions carefully before installation and maintenance.  
The following contents are very important for installation and maintenance.

Please follow the instructions below.

- The installation or maintenance must accord with the instructions.
- Comply with all national electrical codes and local electrical codes.
- Pay attention to the warnings and cautions in this manual.
- All installation and maintenance shall be performed by distributor or qualified person.
- All electric work must be performed by a licensed technician according to local regulations and the instructions given in this manual.
- Be caution during installation and maintenance. Prohibit incorrect operation to prevent electric shock, casualty and other accidents.



### Warnings

#### Electrical Safety Precautions:

1. Cut off the power supply of air conditioner before checking and maintenance.
2. The air condition must apply specialized circuit and prohibit share the same circuit with other appliances.
3. The air conditioner should be installed in suitable location and ensure the power plug is touchable.
4. Make sure each wiring terminal is connected firmly during installation and maintenance.
5. Have the unit adequately grounded. The grounding wire Can't be used for other purposes.
6. Must apply protective accessories such as protective boards, cable-cross loop and wire clip.
7. The live wire, neutral wire and grounding wire of power supply must be corresponding to the live wire, neutral wire and grounding wire of the air conditioner.
8. The power cord and power connection wires Can't be pressed by hard objects.
9. If power cord or connection wire is broken, it must be replaced by a qualified person.
10. If the power cord or connection wire is not long

enough, please get the specialized power cord or connection wire from the manufacture or distributor. Prohibit prolong the wire by yourself.

11. For the air conditioner without plug, an air switch must be installed in the circuit. The air switch should be all-pole parting and the contact parting distance should be more than 3mm.
12. Make sure all wires and pipes are connected properly and the valves are opened before energizing.
13. Check if there is electric leakage on the unit body. If yes, please eliminate the electric leakage.
14. Replace the fuse with a new one of the same specification if it is burnt down; dont replace it with a cooper wire or conducting wire.
15. If the unit is to be installed in a humid place, the circuit breaker must be installed.

#### Installation Safety Precautions:

1. Select the installation location according to the requirement of this manual.(See the requirements in installation part)
2. Handle unit transportation with care; the unit should not be carried by only one person if it is more than 20kg.
3. When installing the indoor unit and outdoor unit, a sufficient fixing bolt must be installed; make sure the installation support is firm.
4. Ware safety belt if the height of working is above 2m.
5. Use equipped components or appointed components during installation.
6. Make sure no foreign objects are left in the unit after finishing installation.

#### Refrigerant Safety Precautions:

When refrigerant leaks or requires discharge during installation, maintenance, or disassembly, it should be handled by certified professionals or otherwise in compliance with local laws and regulations.

1. Avoid contact between refrigerant and fire as it generates poisonous gas; Prohibit prolong the connection pipe by welding.
2. Apply specified refrigerant only. Never have it mixed with any other refrigerant. Never have air remain in the refrigerant line as it may lead to rupture or other hazards.
3. Make sure no refrigerant gas is leaking out when installation is completed.
4. If there is refrigerant leakage, please take sufficient measure to minimize the density of refrigerant.
5. Never touch the refrigerant piping or compressor without wearing glove to avoid scald or frostbite.

Improper installation may lead to fire hazard, explosion, electric shock or injury.

# Safety Precautions for Installing and Relocating the Unit:

To ensure safety, please be mindful of the following precautions.



## Warnings

**1. When installing or relocating the unit, be sure to keep the refrigerant circuit free from air or substances other than the specified refrigerant.**

Any presence of air or other foreign substance in the refrigerant circuit will cause system pressure rise or compressor rupture, resulting in injury.

**2. When installing or moving this unit, do not charge the refrigerant which is not comply with that on the nameplate or unqualified refrigerant.**

Otherwise, it may cause abnormal operation, wrong action, mechanical malfunction or even series safety accident.

**3. When refrigerant needs to be recovered during relocating or repairing the unit, be sure that the unit is running in cooling mode. Then, fully close the valve at high pressure side (liquid valve). About 30-40 seconds later, fully close the valve at low pressure side (gas valve), immediately stop the unit and disconnect power. Please note that the time for refrigerant recovery should not exceed 1 minute.**

If refrigerant recovery takes too much time, air may be sucked in and cause pressure rise or compressor rupture, resulting in injury.

**4. During refrigerant recovery, make sure that liquid valve and gas valve are fully closed and power is disconnected before detaching the connection pipe.**

If compressor starts running when stop valve is open and connection pipe is not yet connected, air will be sucked in and cause pressure rise or compressor rupture, resulting in injury.

**5. When installing the unit, make sure that connection pipe is securely connected before the compressor starts running.**

If compressor starts running when stop valve is open and connection pipe is not yet connected, air will be sucked in and cause pressure rise or compressor rupture, resulting in injury.

**6. Prohibit installing the unit at the place where there may be leaked corrosive gas or flammable gas.**

If there leaked gas around the unit, it may cause explosion and other accidents.

**7. Do not use extension cords for electrical connections. If the electric wire is not long enough, please contact a local service center authorized and ask for a proper electric wire.**

Poor connections may lead to electric shock or fire.

**8. Use the specified types of wires for electrical connections between the indoor and outdoor units. Firmly clamp the wires so that their terminals receive no external stresses.**

Electric wires with insufficient capacity, wrong wire connections and insecure wire terminals may cause electric shock or fire.

## Safety Precautions for Refrigerant

•To realize the function of the air conditioner unit, a special refrigerant circulates in the system. The used refrigerant is the fluoride R32, which is specially cleaned. The refrigerant is flammable and inodorous. Furthermore, it can lead to explosion under certain conditions. But the flammability of the refrigerant is very low. It can be ignited only by fire.

•Compared to common refrigerants, R32 is a nonpolluting refrigerant with no harm to the ozoneosphere. The influence upon the greenhouse effect is also lower. R32 has got very good thermodynamic features which lead to a really high energy efficiency. The units therefore need a less filling.

### WARNING:

•Do not use means to accelerate the defrosting process or to clean, other than those recommended by the manufacture.

Should repair be necessary, contact your nearest authorized Service Centre. Any repairs carried out by unqualified personnel may be dangerous. The appliance shall be stored in a room without continuously operating ignition sources. (for example: open flames, an operating gas appliance or an operating electric heater.)

•Do not pierce or burn.

•Appliance shall be installed, operated and stored in a room with a floor area larger than  $Xm^2$ . (Please refer to table "a" in section of " Safety Operation of Inflammable Refrigerant" for Space X.)

•Appliance filled with flammable gas R32. For repairs, strictly follow manufacturer's instructions only. Be aware that refrigerants not contain odour. Read specialist's manual.



# Safety Operation of Flammable Refrigerant

## Qualification requirement for installation and maintenance man

- All the work men who are engaging in the refrigeration system should bear the valid certification awarded by the authoritative organization and the qualification for dealing with the refrigeration system recognized by this industry. If it needs other technician to maintain and repair the appliance, they should be supervised by the person who bears the qualification for using the flammable refrigerant.
- It can only be repaired by the method suggested by the equipments manufacturer.

## Installation notes

- The air conditioner is not allowed to use in a room that has running fire (such as fire source, working coal gas ware, operating heater).
- It is not allowed to drill hole or burn the connection pipe.
- The air conditioner must be installed in a room that is larger than the minimum room area.  
The minimum room area is shown on the nameplate or following table a.
- Leak test is a must after installation.

table a - Minimum room area(m<sup>2</sup>)

Minimum room area( m <sup>2</sup> )	Charge amount (kg)	≤1.2	1.3	1.4	1.5	1.6	1.7	1.8	1.9	2	2.1	2.2	2.3	2.4	2.5
	floor location	4	14.5	16.8	19.3	22	24.8	27.8	31	34.3	37.8	41.5	45.4	49.4	53.6
window mounted	4	5.2	6.1	7	7.9	8.9	10	11.2	12.4	13.6	15	16.3	17.8	19.3	
wall mounted	4	4	4	4	4	4	4	4	4	4.2	4.6	5	5.5	6	
ceiling mounted	4	4	4	4	4	4	4	4	4	4	4	4	4	4	4

## Maintenance notes

- Check whether the maintenance area or the room area meet the requirement of the nameplate.  
— Its only allowed to be operated in the rooms that meet the requirement of the nameplate.
- Check whether the maintenance area is well-ventilated.  
— The continuous ventilation status should be kept during the operation process.
- Check whether there is fire source or potential fire source in the maintenance area.  
— The naked flame is prohibited in the maintenance area; and the “no smoking” warning board should be hanged.
- Check whether the appliance mark is in good condition.  
— Replace the vague or damaged warning mark.

## Welding

- If you should cut or weld the refrigerant system pipes in the process of maintaining, please follow the steps as below:
  - a. Shut down the unit and cut power supply
  - b. Eliminate the refrigerant
  - c. Vacuuming
  - d. Clean it with N<sub>2</sub> gas
  - e. Cutting or welding
  - f. Carry back to the service spot for welding
- Make sure that there isnt any naked flame near the outlet of the vacuum pump and its well-ventilated.
- The refrigerant should be recycled into the specialized storage tank.

## Filling the refrigerant

- Use the refrigerant filling appliances specialized for R32. Make sure that different kinds of refrigerant wont contaminate with each other.
- The refrigerant tank should be kept upright at the time of filling refrigerant.
- Stick the label on the system after filling is finished (or havent finished).
- Dont overfilling.
- After filling is finished, please do the leakage detection before test running; another time of leak detection should be done when its removed.

## Safety instructions for transportation and storage

- Please use the flammable gas detector to check before unload and open the container.
- No fire source and smoking.
- According to the local rules and laws.

## Main Tools for Installation and Maintenance

<p>1. Level meter, measuring tape</p> 	<p>2. Screw driver</p> 	<p>3. Impact drill, drill head, electric drill</p> 
<p>4. Electroprobe</p> 	<p>5. Universal meter</p> 	<p>6. Torque wrench, open-end wrench, inner hexagon spanner</p> 
<p>7. Electronic leakage detector</p> 	<p>8. Vacuum pump</p> 	<p>9. Pressure meter</p> 
<p>10. Pipe pliers, pipe cutter</p> 	<p>11. Pipe expander, pipe bender</p> 	<p>12. Soldering appliance, refrigerant container</p> 



## 8. Installation

### 8.1 Installation Dimension Diagram

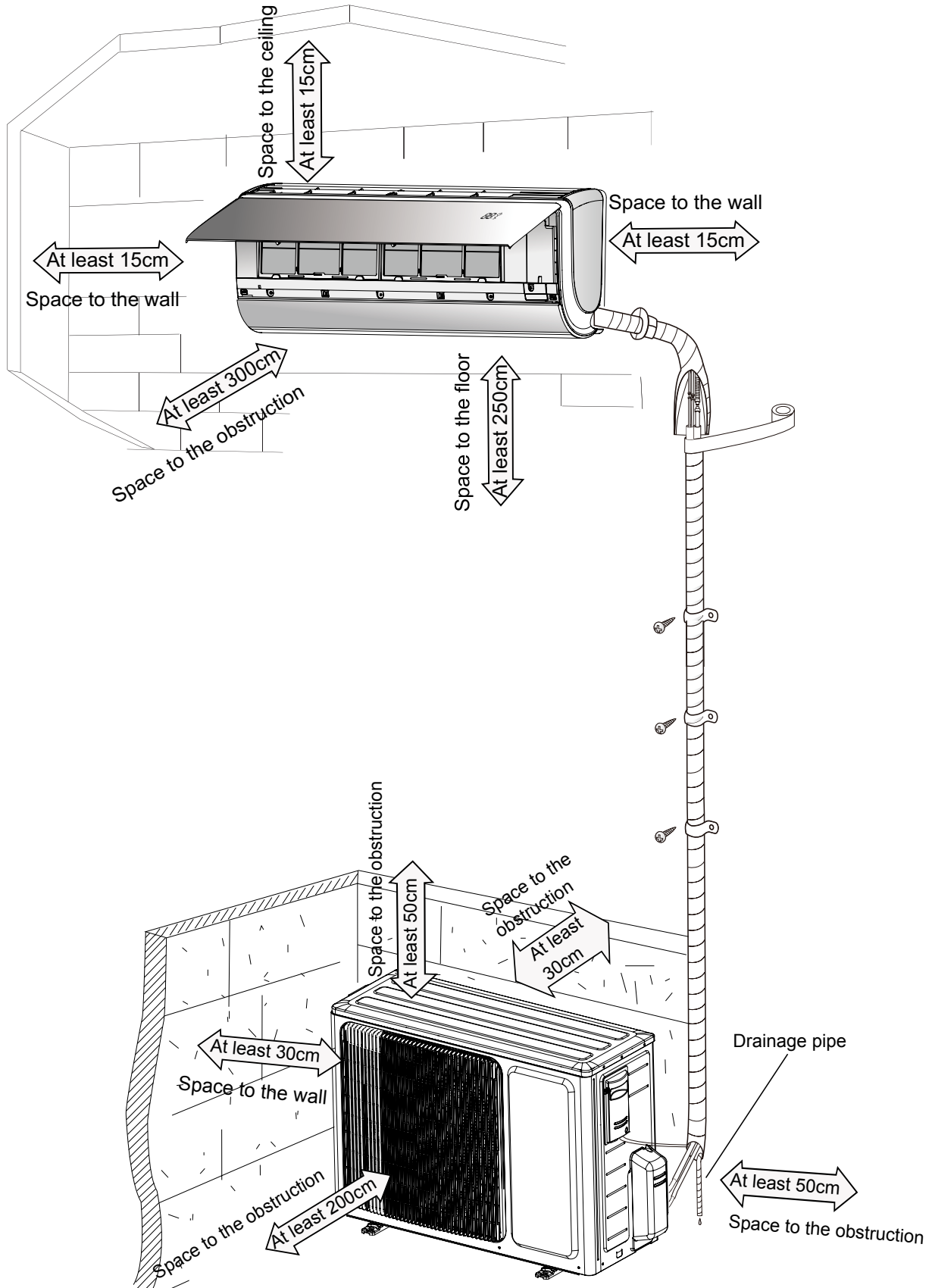



## 8.2 Installation Parts-checking

No.	Name	No.	Name
1	Indoor unit	8	Sealing gum
2	Outdoor unit	9	Wrapping tape
3	Connection pipe	10	Support of outdoor unit
4	Drainage pipe	11	Fixing screw
5	Wall-mounting frame	12	Drainage plug(cooling and heating unit)
6	Connecting cable(power cord)	13	Owners manual, remote controller
7	Wall pipe		

### ⚠ Note:

- 1.Please contact the local agent for installation.
- 2.Dont use unqualified power cord.

## 8.3 Selection of Installation Location

### 1. Basic Requirement:

Installing the unit in the following places may cause malfunction. If it is unavoidable, please consult the local dealer:

- (1) The place with strong heat sources, vapors, flammable or explosive gas, or volatile objects spread in the air.
- (2) The place with high-frequency devices (such as welding machine, medical equipment).
- (3) The place near coast area.
- (4) The place with oil or fumes in the air.
- (5) The place with sulfureted gas.
- (6) Other places with special circumstances.
- (7) The appliance shall not be installed in the laundry.
- (8) It's not allowed to be installed on the unstable or motive base structure (such as truck) or in the corrosive environment (such as chemical factory).

### 2. Indoor Unit:

- (1) There should be no obstruction near air inlet and air outlet.
- (2) Select a location where the condensation water can be dispersed easily and wont affect other people.
- (3) Select a location which is convenient to connect the outdoor unit and near the power socket.
- (4) Select a location which is out of reach for children.
- (5) The location should be able to withstand the weight of indoor unit and wont increase noise and vibration.
- (6) The appliance must be installed 2.5m above floor.
- (7) Dont install the indoor unit right above the electric appliance.
- (8) Please try your best to keep way from fluorescent lamp.

### 3. Outdoor Unit:

- (1) Select a location where the noise and outflow air emitted by the outdoor unit will not affect neighborhood.
- (2) The location should be well ventilated and dry, in which the outdoor unit wont be exposed directly to sunlight or strong wind.
- (3) The location should be able to withstand the weight of outdoor unit.
- (4) Make sure that the installation follows the requirement of installation dimension diagram.
- (5) Select a location which is out of reach for children and far away from animals or plants.If it is unavoidable, please add fence for safety purpose.

## 8.4 Requirements for electric connection

### 1. Safety Precaution

- (1) Must follow the electric safety regulations when installing the unit.
- (2) According to the local safety regulations, use qualified power supply circuit and air switch.
- (3) Make sure the power supply matches with the requirement of air conditioner. Unstable power supply or incorrect wiring may result in electric shock,fire hazard or malfunction. Please install proper power supply cables before using the air conditioner.
- (4) Properly connect the live wire, neutral wire and grounding wire of power socket.
- (5) Be sure to cut off the power supply before proceeding any work related to electricity and safety.
- (6) Do not put through the power before finishing installation.
- (7) If the supply cord is damaged,it must be replaced by the manufacturer,its service agent or similarly qualified persons in order to avoid a hazard.
- (8) The temperature of refrigerant circuit will be high, please keep the interconnection cable away from the copper tube.
- (9) The appliance shall be installed in accordance with national wiring regulations.
- (10) Appliance shall be installed, operated and stored in a room with a floor area larger than  $Xm^2$ (Please refer to table "a" in section of " Safety Operation of Inflammable Refrigerant" for Space X.)



Please notice that the unit is filled with flammable gas R32. Inappropriate treatment of the unit involves the risk of severe damages of people and material. Details to this refrigerant are found in chapter "refrigerant".

### 2. Grounding Requirement:

- (1) The air conditioner is first class electric appliance. It must be properly grounding with specialized grounding device by a professional. Please make sure it is always grounded effectively, otherwise it may cause electric shock.
- (2) The yellow-green wire in air conditioner is grounding wire, which cant be used for other purposes.
- (3) The grounding resistance should comply with national electric safety regulations.
- (4) The appliance must be positioned so that the plug is accessible.
- (5) An all-pole disconnection switch having a contact separation of at least 3mm in all poles should be connected in fixed wiring.
- (6) Including an air switch with suitable capacity, please note the following table. Air switch should be included magnet buckle and heating buckle function, it can protect the circuit-short and overload. (Caution: please do not use the fuse only for protect the circuit)

Air-conditioner	Air switch capacity
09/12/18K	16A

## 8.5 Installation of Indoor Unit

### 1. Choosing Installation location

Recommend the installation location to the client and then confirm it with the client.

### 2. Install Wall-mounting Frame

- (1) Hang the wall-mounting frame on the wall; adjust it in horizontal position with the level meter and then point out the screw fixing holes on the wall.

(2) Drill the screw fixing holes on the wall with impact drill (the specification of drill head should be the same as the plastic expansion particle) and then fill the plastic expansion particles in the holes.

(3) Fix the wall-mounting frame on the wall with tapping screws and then check if the frame is firmly installed by pulling the frame. If the plastic expansion particle is loose, please drill another fixing hole nearby.

(2) Drill the screw fixing holes on the wall with impact drill (the specification of drill head should be the same as the plastic expansion particle) and then fill the plastic expansion particles in the holes.

(3) Fix the wall-mounting frame on the wall with tapping screws and then check if the frame is firmly installed by pulling the frame. If the plastic expansion particle is loose, please drill another fixing hole nearby.

### 3. Install Wall-mounting Frame

(1) Choose the position of piping hole according to the direction of outlet pipe. The position of piping hole should be a little lower than the wall-mounted frame.(As show in Fig.1)

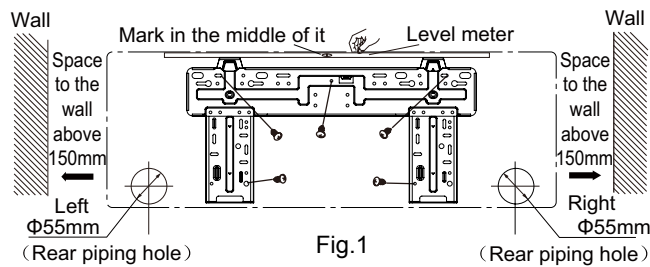

(2) Open a piping hole with the diameter of Φ55mm on the selected outlet pipe position. In order to drain smoothly, slant the piping hole on the wall slightly downward to the outdoor side with the gradient of 5-10°.(As show in Fig.2)

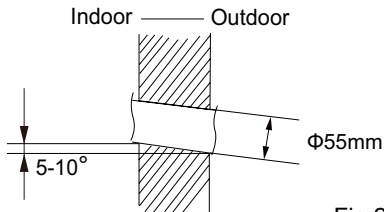

#### ⚠ Note:

(1) Pay attention to dust prevention and take relevant safety measures when opening the hole.

### 4. Outlet Pipe

(1) The pipe can be led out in the direction of right, rear right, left or rear left.(As show in Fig.3)

(2) When selecting leading out the pipe from left or right, please cut off the corresponding hole on the bottom case.(As show in Fig.4)

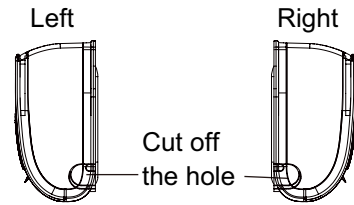
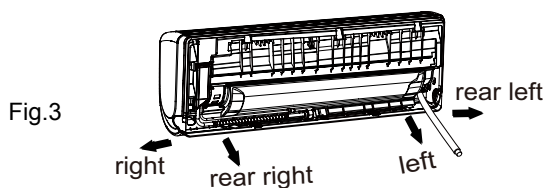

Fig.4

### 5. Connect the Pipe of Indoor Unit

(1) Aim the pipe joint at the corresponding bellmouth.(As show in Fig.5)

(2) Pretightening the union nut with hand.

(3) Adjust the torque force by referring to the following sheet. Place the open-end wrench on the pipe joint and place the torque wrench on the union nut. Tighten the union nut with torque wrench.(As show in Fig.6)

(4) Wrap the indoor pipe and joint of connection pipe with insulating pipe, and then wrap it with tape.(As show in Fig.7)

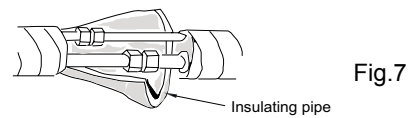
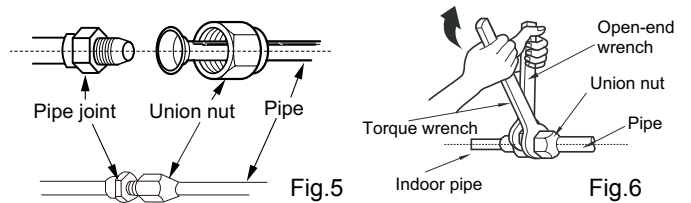

Refer to the following table for wrench moment of force:

Hex nut diameter(mm)	Tightening torque(N·m)
Φ6	15~20
Φ9.52	30~40
Φ12	45~55
Φ16	60~65
Φ19	70~75

### 6. Install Drain Hose

(1) Connect the drain hose to the outlet pipe of indoor unit.(As show in Fig.8)

(2) Bind the joint with tape.(As show in Fig.9)

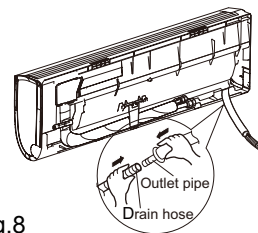

Fig.8

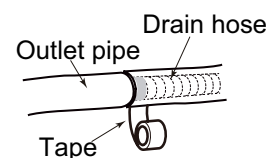

Fig.9

#### ⚠ Note:

(1) Add insulating pipe in the indoor drain hose in order to prevent condensation.

(2) The plastic expansion particles are not provided.(As show in Fig.10)

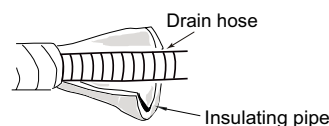
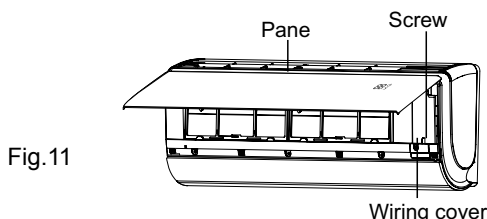

Fig.10

### 7. Connect Wire of Indoor Unit

(1) Open the panel, remove the screw on the wiring cover and then take down the cover.(As show in Fig.11)



(2) Make the power connection wire go through the cable-cross hole at the back of indoor unit and then pull it out from the front side.(As show in Fig.12)

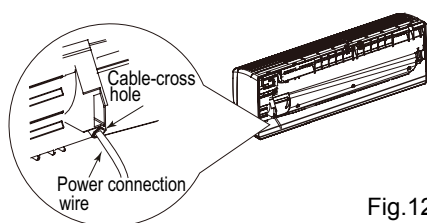

(3) Remove the wire clip; connect the power connection wire to the wiring terminal according to the color; tighten the screw and then fix the power connection wire with wire clip.After finishing wiring of 18K unit, clamp the grounding wire (yellow-green wire) into the wire-crossing groove(As show in Fig.13), in order to avoid pressing the wire when closing the electric box cover.(As show in Fig.13)

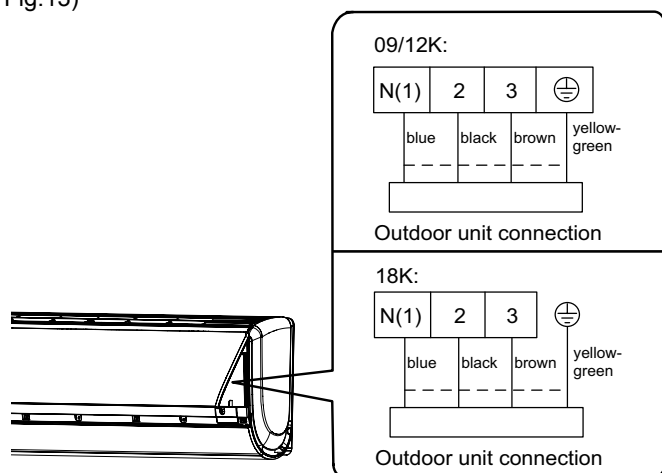

Note: the wiring connect is for reference only, please refer to the actual one.

Fig.13

4.Put wiring cover back and then tighten the screw.  
5.Close the panel.

#### ⚠ Note:

- (1) All wires of indoor unit and outdoor unit should be connected by a professional.
- (2) If the length of power connection wire is insufficient, please contact the supplier for a new one. Avoid extending the wire by yourself.
- (3) For the air conditioner with plug, the plug should be reachable after finishing installation.
- (4) For the air conditioner without plug, an air switch must be installed in the line. The air switch should be all-pole parting and the contact parting distance should be more than 3mm.

### 8. Bind up Pipe

- (1) Bind up the connection pipe, power cord and drain hose with the band.(As show in Fig.14)
- (2) Reserve a certain length of drain hose and power cord for installation when binding them. When binding to a certain degree, separate the indoor power and then separate the drain hose.(As show in Fig.15)
- (3) Bind them evenly.
- (4) The liquid pipe and gas pipe should be bound separately at the end.

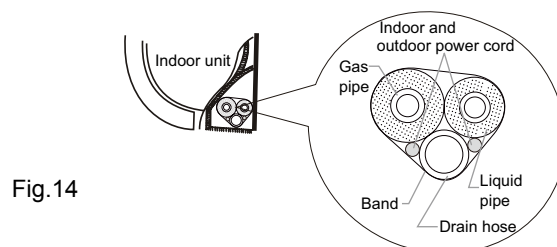

Fig.14

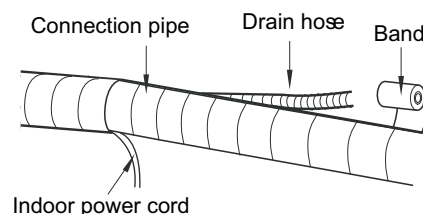

Fig.15

#### ⚠ Note:

- (1) The power cord and control wire cant be crossed or winding.
- (2) The drain hose should be bound at the bottom.

### 9. Hang the Indoor Unit

- (1) Put the bound pipes in the wall pipe and then make them pass through the wall hole.
- (2) Hang the indoor unit on the wall-mounting frame.
- (3) Stuff the gap between pipes and wall hole with sealing gum.
- (4) Fix the wall pipe.(As show in Fig.16)
- (5) Check if the indoor unit is installed firmly and closed to the wall.(As show in Fig.17)

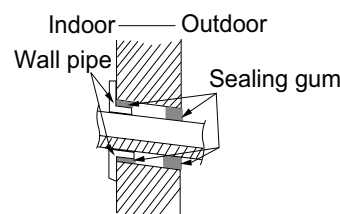

Fig.16

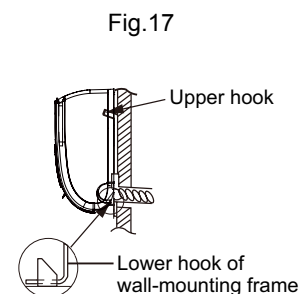

Fig.17

#### ⚠ Note:

Do not bend the drain hose too excessively in order to prevent blocking.

## 8.6 Installation of Outdoor Unit

### 1. Fix the Support of Outdoor Unit(Select it according to the actual installation situation)

- (1) Select installation location according to the house structure.
- (2) Fix the support of outdoor unit on the selected location with expansion screws.

**⚠ Note:**

- (1) Take sufficient protective measures when installing the outdoor unit.
- (2) Make sure the support can withstand at least four times the unit weight.
- (3) The outdoor unit should be installed at least 3cm above the floor in order to install drain joint.(As show in Fig.18)
- (4) For the unit with cooling capacity of 2300W~5000W, 6 expansion screws are needed; for the unit with cooling capacity of 6000W~8000W, 8 expansion screws are needed; for the unit with cooling capacity of 10000W~16000W, 10 expansion screws are needed.

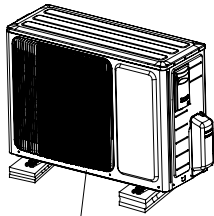

At least 3cm above the floor

Fig.18

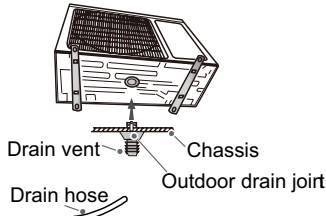

Fig.19

### 2. Install Drain Joint(Only for cooling and heating unit)

- (1) Connect the outdoor drain joint into the hole on the chassis.
- (2) Connect the drain hose into the drain vent.

NOTE:As for the shape of drainage joint,please refer to the current product.Do not install the drainage joint in the severe cold area.Otherwise,it will be frosted and then cause malfunction.(As show in Fig.19)

### 3. Fix Outdoor Unit

- (1) Place the outdoor unit on the support.
  - (2) Fix the foot holes of outdoor unit with bolts.
- (As show in Fig.20)

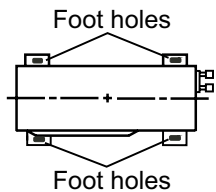

Fig.20

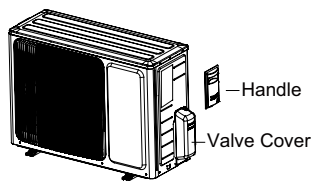

Fig.21

### 4. Connect Indoor and Outdoor Pipes

- (1) Remove the screw on the right handle and valve cover of outdoor unit and then remove the handle and valve cover.(As show in Fig.21)
- (2) Remove the screw cap of valve and aim the pipe joint at the bellmouth of pipe.(As show in Fig.22)

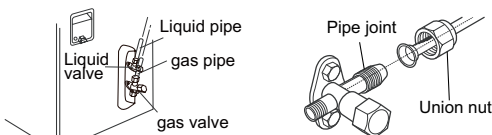

Fig.22

- (3) Pretightening the union nut with hand.
- (4) Tighten the union nut with torque wrench .

Refer to the following table for wrench moment of force:

Hex nut diameter(mm)	Tightening torque(N·m)
Φ6	15~20
Φ9.52	30~40
Φ12	45~55
Φ16	60~65
Φ19	70~75

### 5. Connect Outdoor Electric Wire

- (1) Remove the wire clip; connect the power connection wire and power cord to the wiring terminal according to the color ; fix the them with screws.(As show in Fig.23)

Fig.23

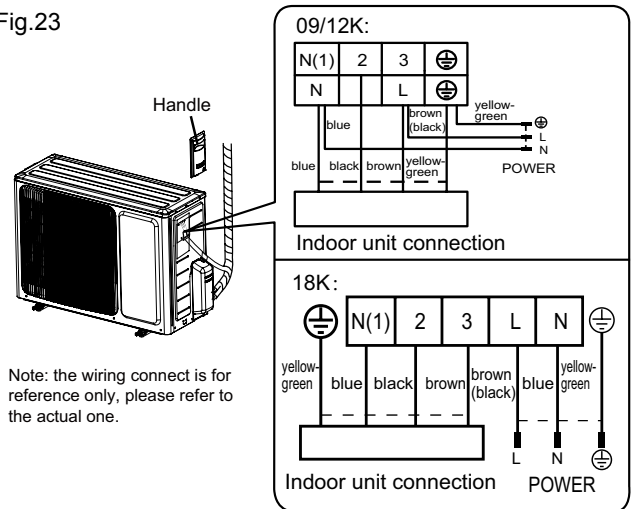

- (2) Fix the power connection wire and power cord with wire clip.

**⚠ Note:**

- (1) After tightening the screw, pull the power cord slightly to check if it is firm.
- (2) Never cut the power connection wire to prolong or shorten the distance.

### 6. Neaten the Pipes

- (1) The pipes should be placed along the wall, bent reasonably and hidden possibly. Min. semidiameter of bending the pipe is 10cm.
- (2) If the outdoor unit is higher than the wall hole, you must set a U-shaped curve in the pipe before pipe goes into the room, in order to prevent rain from getting into the room.(As show in Fig.24)

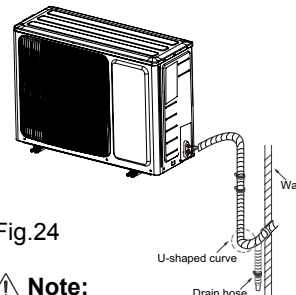

Fig.24

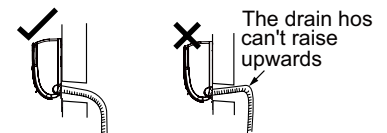
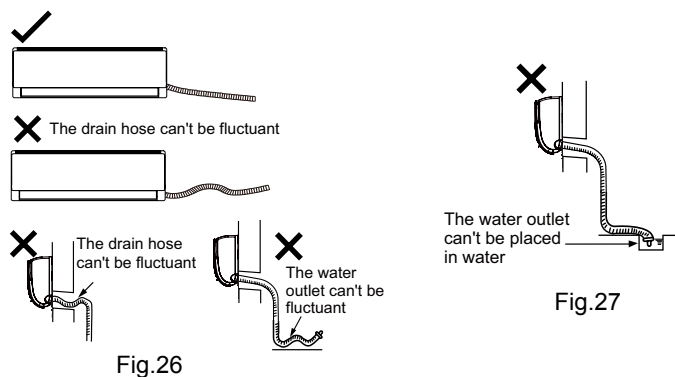

Fig.25

**⚠ Note:**

- (1) The through-wall height of drain hose shouldnt be higher than the outlet pipe hole of indoor unit.(As show in Fig.25)
- (2) Slant the drain hose slightly downwards. The drain hose cant be curved, raised and fluctuant, etc.(As show in Fig.26)

(3) The water outlet can't be placed in water in order to drain smoothly.(As show in Fig.27)



## 8.7 Vacuum Pumping and Leak Detection

### 1. Use Vacuum Pump

- (1) Remove the valve caps on the liquid valve and gas valve and the nut of refrigerant charging vent.
- (2) Connect the charging hose of piezometer to the refrigerant charging vent of gas valve and then connect the other charging hose to the vacuum pump.
- (3) Open the piezometer completely and operate for 10-15min to check if the pressure of piezometer remains in -0.1MPa.
- (4) Close the vacuum pump and maintain this status for 1-2min to check if the pressure of piezometer remains in -0.1MPa. If the pressure decreases, there may be leakage.
- (5) Remove the piezometer, open the valve core of liquid valve and gas valve completely with inner hexagon spanner.
- (6) Tighten the screw caps of valves and refrigerant charging vent.(As show in Fig.28)

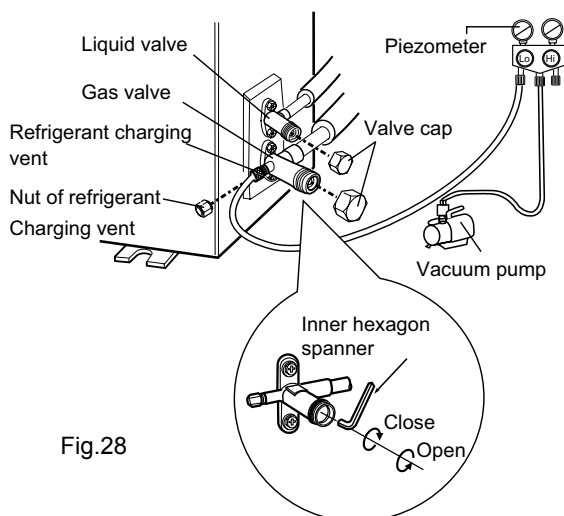

### 2. Leakage Detection

- (1) With leakage detector:  
Check if there is leakage with leakage detector.
- (2) With soap water:  
If leakage detector is not available, please use soap water for leakage detection. Apply soap water at the suspected position and keep the soap water for more than 3min. If there are air bubbles coming out of this position, theres a leakage.

## 8.8 Check after Installation and Test Operation

### 1. Check after Installation

Check according to the following requirement after finishing installation.

NO.	Items to be checked	Possible malfunction
1	Has the unit been installed firmly?	The unit may drop, shake or emit noise.
2	Have you done the refrigerant leakage test?	It may cause insufficient cooling (heating) capacity.
3	Is heat insulation of pipeline sufficient?	It may cause condensation and water dripping.
4	Is water drained well?	It may cause condensation and water dripping.
5	Is the voltage of power supply according to the voltage marked on the nameplate?	It may cause malfunction or damage the parts.
6	Is electric wiring and pipeline installed correctly?	It may cause malfunction or damage the parts.
7	Is the unit grounded securely?	It may cause electric leakage.
8	Does the power cord follow the specification?	It may cause malfunction or damage the parts.
9	Is there any obstruction in air inlet and air outlet?	It may cause insufficient cooling (heating) capacity.
10	The dust and sundries caused during installation are removed?	It may cause malfunction or damaging the parts.
11	The gas valve and liquid valve of connection pipe are open completely?	It may cause insufficient cooling (heating) capacity.
12	Is the inlet and outlet of piping hole been covered?	It may cause insufficient cooling (heating) capacity or waster eletricity.

### 2. Test Operation

- (1) Preparation of test operation
  - The client approves the air conditioner installation.
  - Specify the important notes for air conditioner to the client.
- (2) Method of test operation
  - Put through the power, press ON/OFF button on the remote controller to start operation.
  - Press MODE button to select AUTO, COOL, DRY, FAN and HEAT to check whether the operation is normal or not.
  - If the ambient temperature is lower than 16°C , the air conditioner cant start cooling.

# 9. Maintenance

## 9.1 Error Code List

NO.	Malfunction Name	Display Method of Indoor Unit			A/C status	Possible Causes	
		Dual-8 Code Display	Indicator Display (during blinking, ON 0.5s and OFF 0.5s)				
			Operation Indicator	Cool Indicator			Heating Indicator
1	High pressure protection of system	E1				During cooling and drying operation, except indoor fan operates, all loads stop operation. During heating operation, the complete unit stops.	Possible reasons: 1. Refrigerant was superabundant; 2. Poor heat exchange (including filth blockage of heat exchanger and bad radiating environment ); Ambient temperature is too high.
2	Antifreezing protection	E2				During cooling and drying operation, compressor and outdoor fan stop while indoor fan operates.	1. Poor air-return in indoor unit; 2. Fan speed is abnormal; 3. Evaporator is dirty.
3	Refrigerant leakage protection	F0				The Dual-8 Code Display will show F0 and the complete unit stops.	1.Refrigerant leakage; 2.Indoor evaporator temperature sensor works abnormally; 3.The unit has been plugged up somewhere.
4	High discharge temperature protection of compressor	E4				During cooling and drying operation, compressor and outdoor fan stop while indoor fan operates. During heating operation, all loads stop.	Please refer to the malfunction analysis (discharge protection, overload).
5	Overcurrent protection	E5				During cooling and drying operation, compressor and outdoor fan stop while indoor fan operates. During heating operation, all loads stop.	1. Supply voltage is unstable; 2. Supply voltage is too low and load is too high; 3. Evaporator is dirty.
6	Communication Malfunction	E6				During cooling operation, compressor stops while indoor fan motor operates. During heating operation, the complete unit stops.	Refer to the corresponding malfunction analysis.
7	High temperature resistant protection	E8				During cooling operation: compressor will stop while indoor fan will operate. During heating operation, the complete unit stops.	Refer to the malfunction analysis (overload, high temperature resistant).
8	EEPROM malfunction	EE				During cooling and drying operation, compressor will stop while indoor fan will operate; During heating operation, the complete unit will stop	Replace outdoor control panel AP1
9	Limit/ decrease frequency due to high temperature of module	EU				All loads operate normally, while operation frequency for compressor is decreased	Discharging after the complete unit is de-energized for 20mins, check whether the thermal grease on IPM Module of outdoor control panel AP1 is sufficient and whether the radiator is inserted tightly. If its no use, please replace control panel AP1.
10	Malfunction protection of jumper cap	C5				Wireless remote receiver and button are effective, but can not dispose the related command	1. No jumper cap insert on mainboard. 2. Incorrect insert of jumper cap. 3. Jumper cap damaged. 4. Abnormal detecting circuit of mainboard.



NO.	Malfunction Name	Display Method of Indoor Unit			A/C status	Possible Causes	
		Dual-8 Code Display	Indicator Display (during blinking, ON 0.5s and OFF 0.5s)				
			Operation Indicator	Cool Indicator			Heating Indicator
11	Gathering refrigerant	Fo				When the outdoor unit receive signal of Gathering refrigerant ,the system will be forced to run under cooling mode for gathering refrigerant	Nominal cooling mode
12	Indoor ambient temperature sensor is open/short circuited	F1				During cooling and drying operation, indoor unit operates while other loads will stop; during heating operation, the complete unit will stop operation.	<ol style="list-style-type: none"> <li>1. Loosening or bad contact of indoor ambient temp. sensor and mainboard terminal.</li> <li>2. Components in mainboard fell down leads short circuit.</li> <li>3. Indoor ambient temp. sensor damaged.(check with sensor resistance value chart)</li> <li>4. Mainboard damaged.</li> </ol>
13	Indoor evaporator temperature sensor is open/short circuited	F2				AC stops operation once reaches the setting temperature. Cooling, drying: internal fan motor stops operation while other loads stop operation; heating: AC stop operation	<ol style="list-style-type: none"> <li>1. Loosening or bad contact of Indoor evaporator temp. sensor and mainboard terminal.</li> <li>2. Components on the mainboard fall down leads short circuit.</li> <li>3. Indoor evaporator temp. sensor damaged.(check temp. sensor value chart for testing)</li> <li>4. Mainboard damaged.</li> </ol>
14	Outdoor ambient temperature sensor is open/short circuited	F3				During cooling and drying operating, compressor stops while indoor fan operates; During heating operation, the complete unit will stop operation	Outdoor temperature sensor hasnt been connected well or is damaged. Please check it by referring to the resistance table for temperature sensor)
15	Outdoor condenser temperature sensor is open/short circuited	F4				During cooling and drying operation, compressor stops while indoor fan will operate; During heating operation, the complete unit will stop operation.	Outdoor temperature sensor hasnt been connected well or is damaged. Please check it by referring to the resistance table for temperature sensor)
16	Outdoor discharge temperature sensor is open/short circuited	F5				During cooling and drying operation, compressor will sop after operating for about 3 mins, while indoor fan will operate; During heating operation, the complete unit will stop after operating for about 3 mins.	<ol style="list-style-type: none"> <li>1.Outdoor temperature sensor hasnt been connected well or is damaged. Please check it by referring to the resistance table for temperature sensor)</li> <li>2.The head of temperature sensor hasnt been inserted into the copper tube</li> </ol>
17	Limit/ decrease frequency due to overload	F6				All loads operate normally, while operation frequency for compressor is decreased	Refer to the malfunction analysis (overload, high temperature resistant)
18	Decrease frequency due to overcurrent	F8				All loads operate normally, while operation frequency for compressor is decreased	The input supply voltage is too low; System pressure is too high and overload

NO.	Malfunction Name	Display Method of Indoor Unit			A/C status	Possible Causes	
		Dual-8 Code Display	Indicator Display (during blinking, ON 0.5s and OFF 0.5s)				
			Operation Indicator	Cool Indicator			Heating Indicator
19	Decrease frequency due to high air discharge	F9				All loads operate normally, while operation frequency for compressor is decreased	Overload or temperature is too high; Refrigerant is insufficient; Malfunction of electric expansion valve (EKV)
20	Limit/decrease frequency due to antifreezing	FH				All loads operate normally, while operation frequency for compressor is decreased	Poor air-return in indoor unit or fan speed is too low
21	Voltage for DC bus-bar is too high	PH				During cooling and drying operation, compressor will stop while indoor fan will operate; During heating operation, the complete unit will stop operation.	1. Measure the voltage of position L and N on wiring board (XT), if the voltage is higher than 265VAC, turn on the unit after the supply voltage is increased to the normal range. 2.If the AC input is normal, measure the voltage of electrolytic capacitor C on control panel (AP1), if its normal, theres malfunction for the circuit, please replace the control panel (AP1)
22	Voltage of DC bus-bar is too low	PL				During cooling and drying operation, compressor will stop while indoor fan will operate; During heating operation, the complete unit will stop	1. Measure the voltage of position L and N on wiring board (XT), if the voltage is higher than 150VAC, turn on the unit after the supply voltage is increased to the normal range. 2.If the AC input is normal, measure the voltage of electrolytic capacitor C on control panel (AP1), if its normal, theres malfunction for the circuit, please replace the control panel (AP1)
23	Compressor Min frequency in test state	P0					Showing during min. cooling or min. heating test
24	Compressor rated frequency in test state	P1					Showing during nominal cooling or nominal heating test
25	Compressor maximum frequency in test state	P2					Showing during max. cooling or max. heating test

NO.	Malfunction Name	Display Method of Indoor Unit			A/C status	Possible Causes	
		Dual-8 Code Display	Indicator Display (during blinking, ON 0.5s and OFF 0.5s)				
			Operation Indicator	Cool Indicator			Heating Indicator
26	Compressor intermediate frequency in test state	P3				Showing during middle cooling or middle heating test	
27	Overcurrent protection of phase current for compressor	P5			During cooling and drying operation, compressor will stop while indoor fan will operate; During heating operation, the complete unit will stop operation.	Refer to the malfunction analysis (IPM protection, loss of synchronism protection and overcurrent protection of phase current for compressor).	
28	Charging malfunction of capacitor	PU			During cooling and drying operation, compressor will stop while indoor fan will operate; During heating operation, the complete unit will stop	Refer to the part three—charging malfunction analysis of capacitor	
29	Malfunction of module temperature sensor circuit	P7			During cooling and drying operation, compressor will stop while indoor fan will operate; During heating operation, the complete unit will stop	Replace outdoor control panel AP1	
30	Module high temperature protection	P8			During cooling operation, compressor will stop while indoor fan will operate; During heating operation, the complete unit will stop	After the complete unit is de-energized for 20mins, check whether the thermal grease on IPM Module of outdoor control panel AP1 is sufficient and whether the radiator is inserted tightly. If its no use, please replace control panel AP1.	
31	Decrease frequency due to high temperature resistant during heating operation	H0			All loads operate normally, while operation frequency for compressor is decreased	Refer to the malfunction analysis (overload, high temperature resistant)	
32	Static dedusting protection	H2					
33	Overload protection for compressor	H3			During cooling and drying operation, compressor will stop while indoor fan will operate; During heating operation, the complete unit will stop operation.	1. Wiring terminal OVC-COMP is loosened. In normal state, the resistance for this terminal should be less than 1ohm. 2.Refer to the malfunction analysis (discharge protection, overload)	

NO.	Malfunction Name	Display Method of Indoor Unit				A/C status	Possible Causes
		Dual-8 Code Display	Indicator Display (during blinking, ON 0.5s and OFF 0.5s)				
			Operation Indicator	Cool Indicator	Heating Indicator		
34	System is abnormal	H4				During cooling and drying operation, compressor will stop while indoor fan will operate; During heating operation, the complete unit will stop operation.	Refer to the malfunction analysis (overload, high temperature resistant)
35	IPM protection	H5				During cooling and drying operation, compressor will stop while indoor fan will operate; During heating operation, the complete unit will stop operation.	Refer to the malfunction analysis (IPM protection, loss of synchronism protection and overcurrent protection of phase current for compressor.
36	Internal motor (fan motor) do not operate	H6				Internal fan motor, external fan motor, compressor and electric heater stop operation,guide louver stops at present location.	<ol style="list-style-type: none"> <li>1. Bad contact of DC motor feedback terminal.</li> <li>2. Bad contact of DC motor control end.</li> <li>3. Fan motor is stalling.</li> <li>4. Motor malfunction.</li> <li>5. Malfunction of mainboard rev detecting circuit.</li> </ol>
37	Desynchronizing of compressor	H7				During cooling and drying operation, compressor will stop while indoor fan will operate; During heating operation, the complete unit will stop operation.	Refer to the malfunction analysis (IPM protection, loss of synchronism protection and overcurrent protection of phase current for compressor.
38	Outdoor DC fan motor malfunction	L3				Outdoor DC fan motor malfunction lead to compressor stop operation,	DC fan motor malfunction or system blocked or the connector loosed
39	power protection	L9				compressor stop operation and Outdoor fan motor will stop 30s latter , 3 minutes latter fan motor and compressor will restart	To protect the electrical components when detect high power
40	Indoor unit and outdoor unit doesn't match	LP				compressor and Outdoor fan motor can't work	Indoor unit and outdoor unit doesn't match
41	Failure start-up	LC				During cooling and drying operation, compressor will stop while indoor fan will operate; During heating operation, the complete unit will stop operation.	Refer to the malfunction analysis

NO.	Malfunction Name	Display Method of Indoor Unit			A/C status	Possible Causes	
		Dual-8 Code Display	Indicator Display (during blinking, ON 0.5s and OFF 0.5s)				
			Operation Indicator	Cool Indicator			Heating Indicator
43	Malfunction of phase current detection circuit for compressor	U1			During cooling and drying operation, compressor will stop while indoor fan will operate; During heating operation, the complete unit will stop	Replace outdoor control panel AP1	
44	Malfunction of voltage dropping for DC bus-bar	U3			During cooling and drying operation, compressor will stop while indoor fan will operate; During heating operation, the complete unit will stop	Supply voltage is unstable	
45	Malfunction of complete units current detection	U5			During cooling and drying operation, the compressor will stop while indoor fan will operate; During heating operating, the complete unit will stop operation.	Theres circuit malfunction on outdoor units control panel AP1, please replace the outdoor units control panel AP1.	
46	The four-way valve is abnormal	U7			If this malfunction occurs during heating operation, the complete unit will stop operation.	1.Supply voltage is lower than AC175V; 2.Wiring terminal 4V is loosened or broken; 3.4V is damaged, please replace 4V.	
47	Zero-crossing malfunction of outdoor unit	U9			During cooling operation, compressor will stop while indoor fan will operate; during heating,the complete unit will stop operation.	Replace outdoor control panel AP1	

## 9.2 Procedure of Troubleshooting

### 1. Malfunction of Temperature Sensor F1, F2

Main detection points:

- Is the wiring terminal between the temperature sensor and the controller loosened or poorly contacted?
- Is there short circuit due to trip-over of the parts?
- Is the temperature sensor broken?
- Is mainboard broken?

Malfunction diagnosis process:

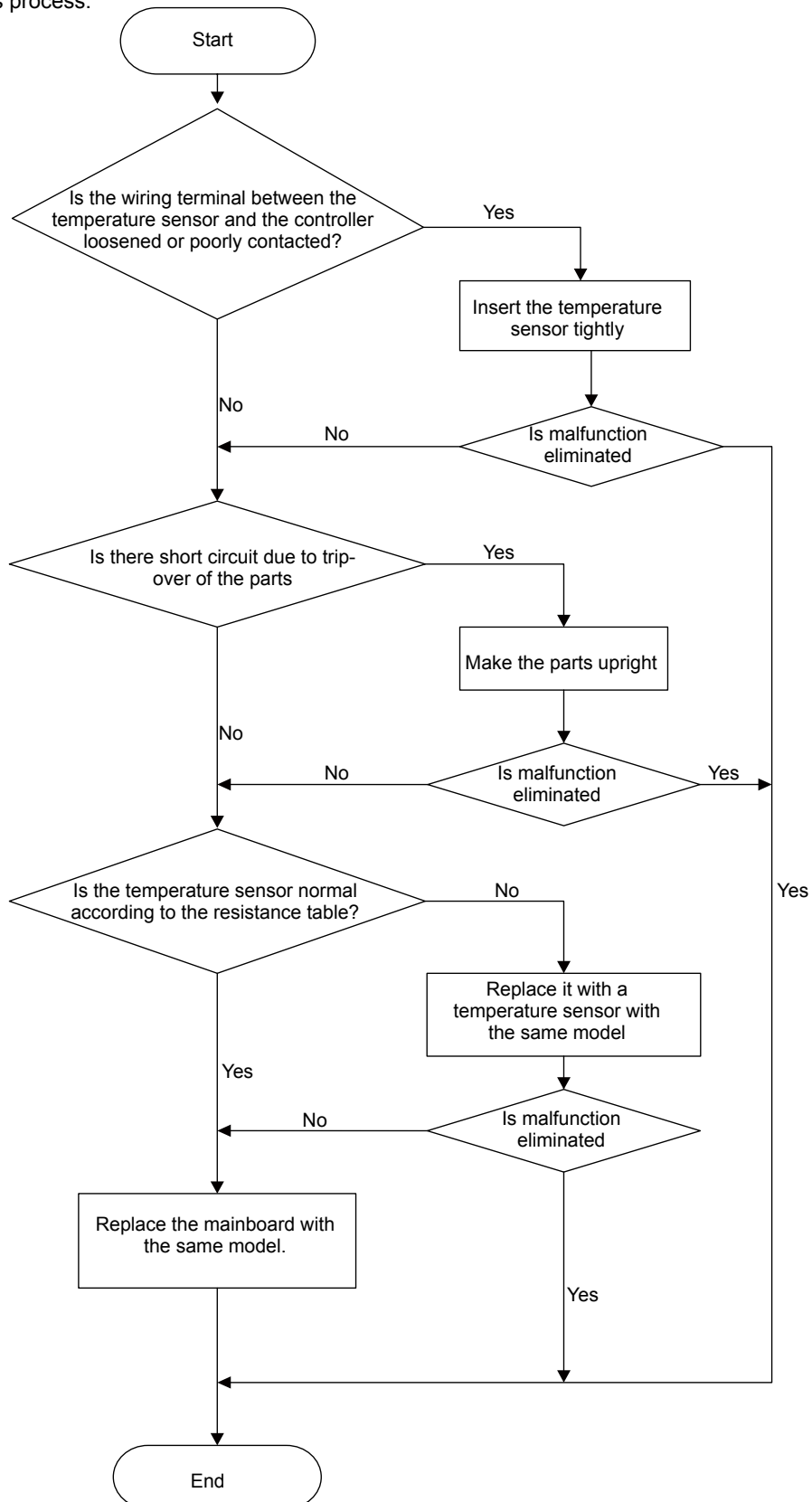

## 2. Malfunction of Blocked Protection of IDU Fan Motor H6

Main detection points:

- Smoothly Is the control terminal of PG motor connected tightly?
- Smoothly Is the feedback interface of PG motor connected tightly?
- The fan motor cant operate?
- The motor is broken?
- Detection circuit of the mainboard is defined abnormal?

Malfunction diagnosis process:

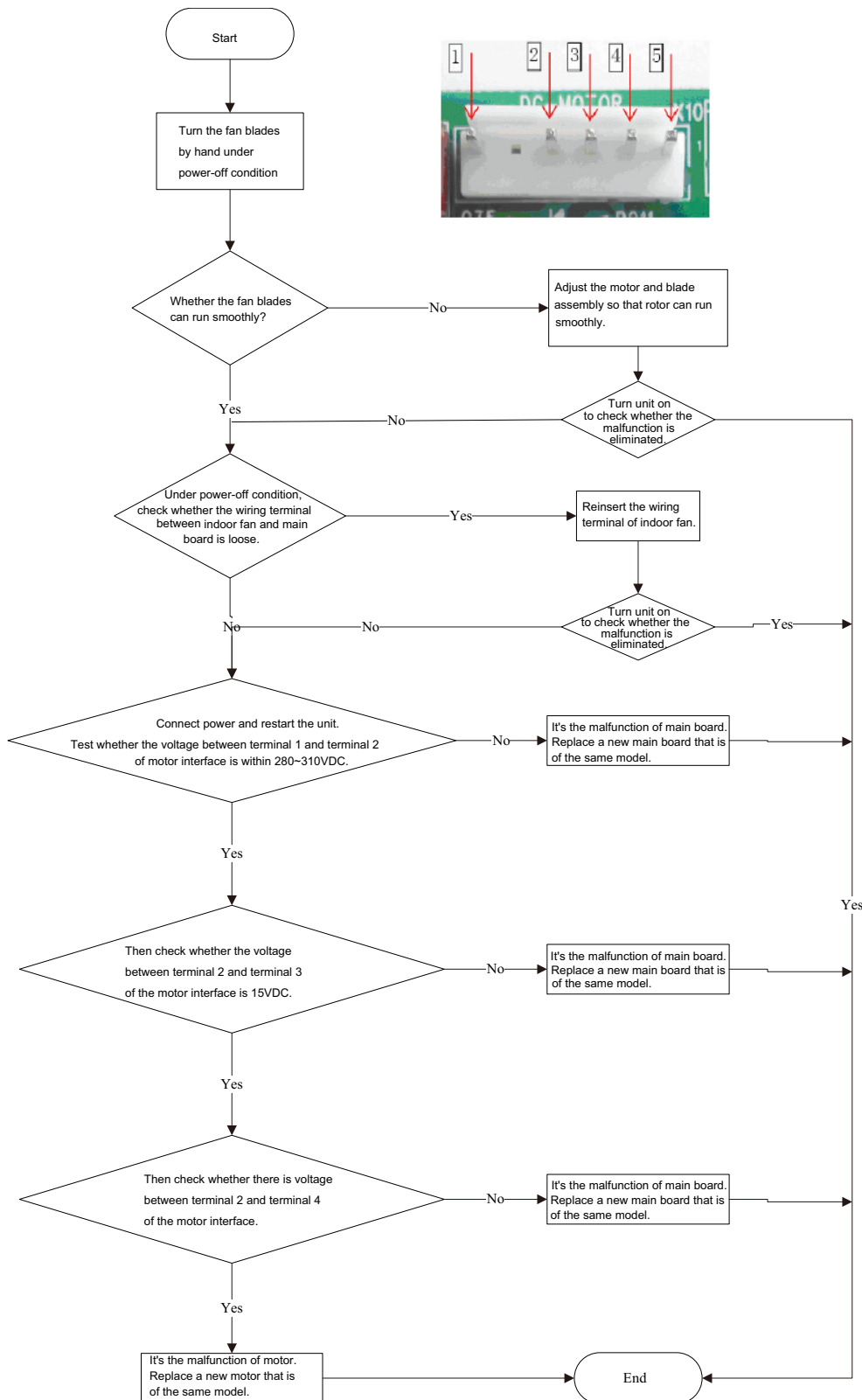

### 3. Malfunction of Protection of Jumper Cap C5

Main detection points:

- Is there jumper cap on the mainboard?
- Is the jumper cap inserted correctly and tightly?
- The jumper is broken?
- The motor is broken?
- Detection circuit of the mainboard is defined abnormal?

Malfunction diagnosis process:

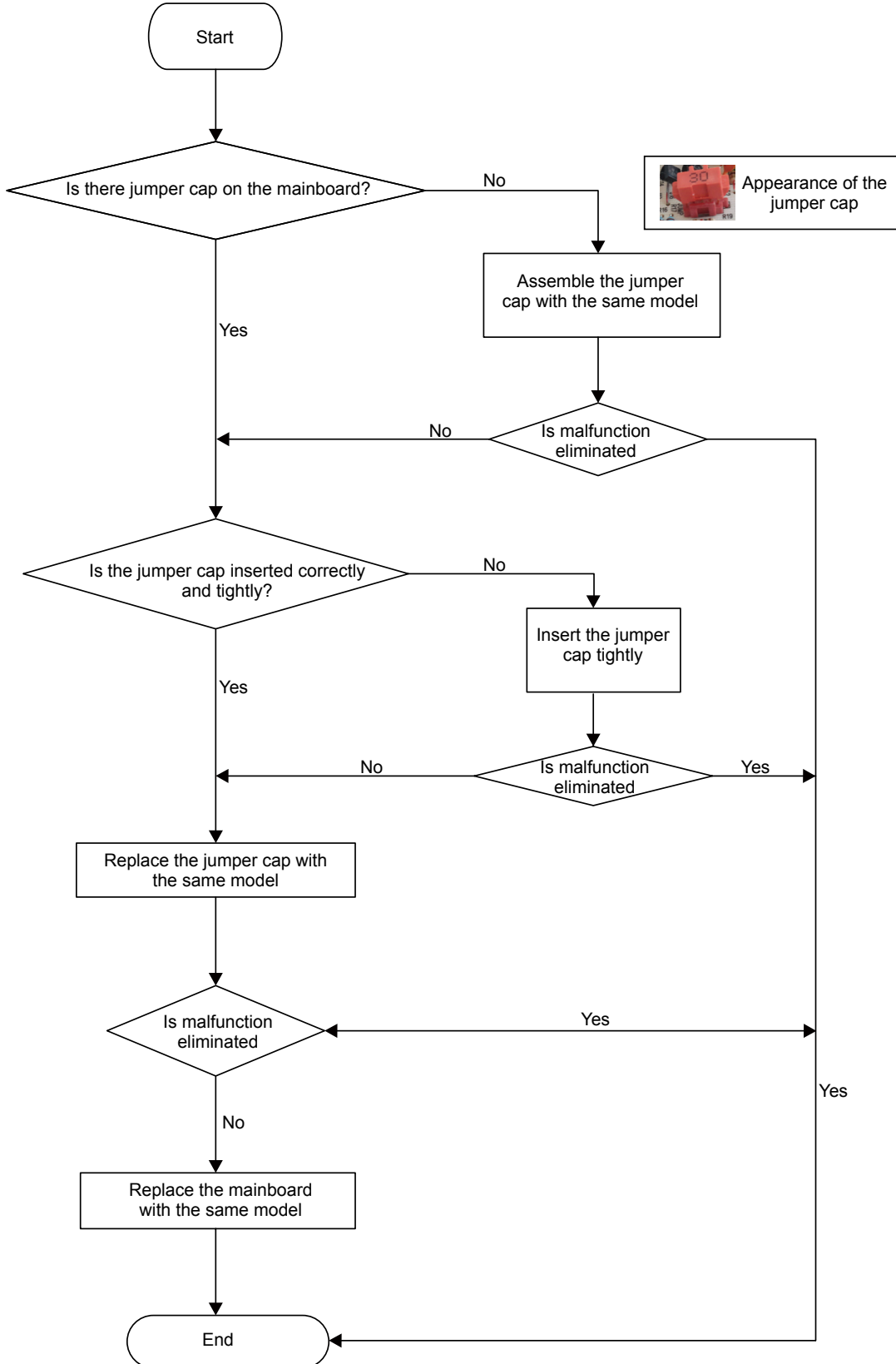

Appearance of the jumper cap



#### 4. Malfunction of Overcurrent Protection E5

Main detection points:

- Is the supply voltage unstable with big fluctuation?
- Is the supply voltage too low with overload?
- Hardware trouble?

Malfunction diagnosis process:

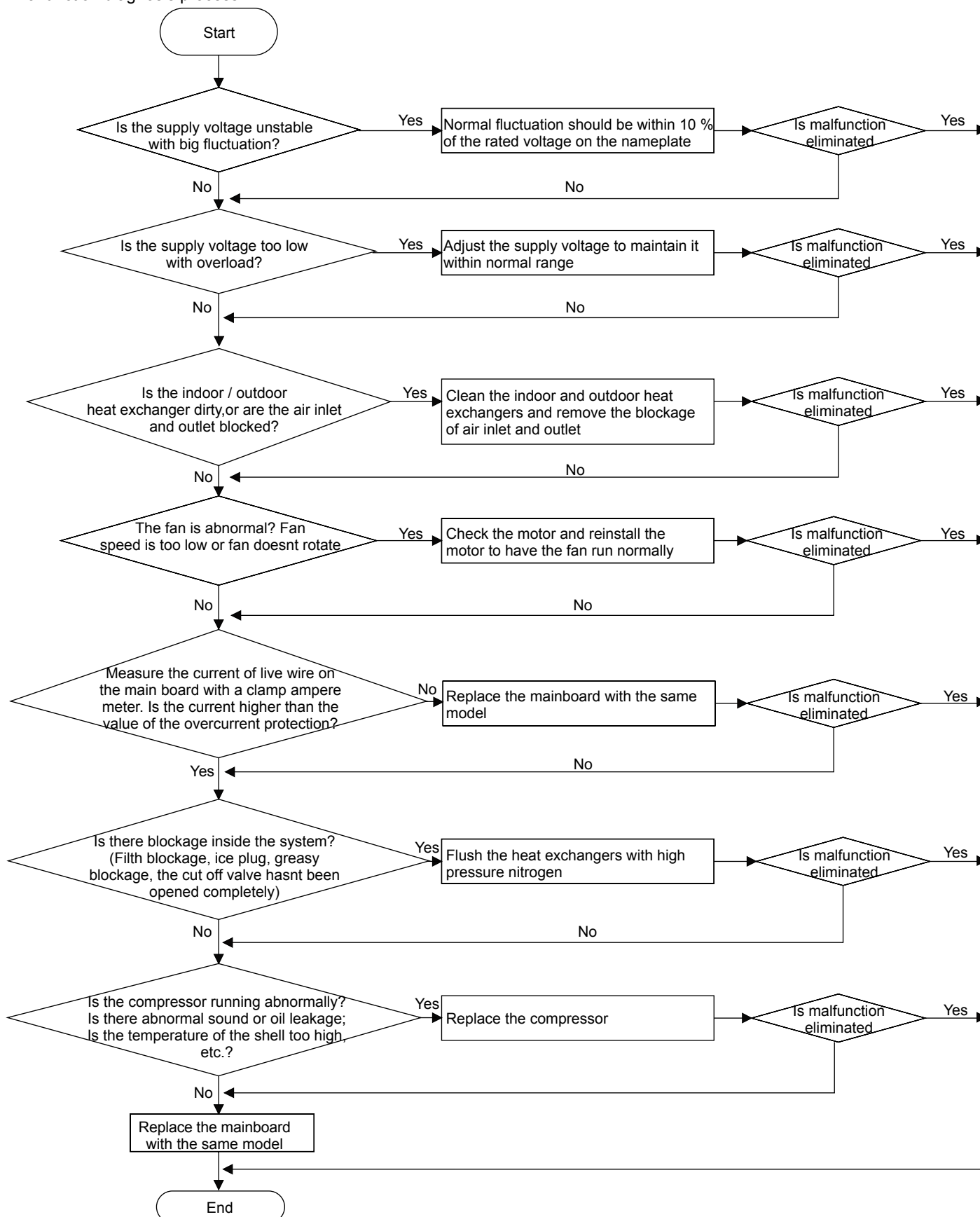

### 5. Communication Malfunction E6

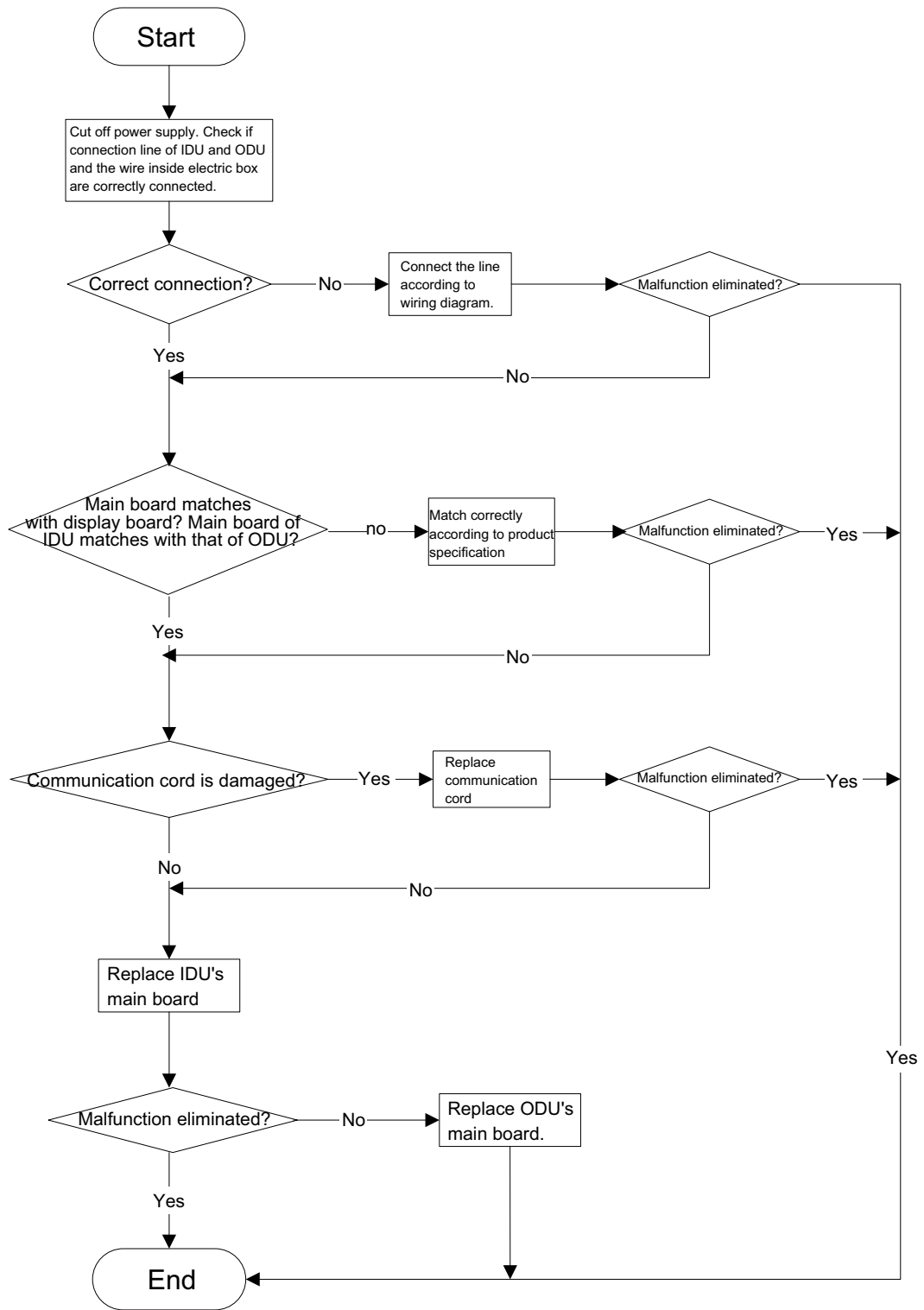

## 6. Malfunction of Zero-crossing Inspection Circuit Malfunction of the IDU Fan Motor U8

Main detection points:

- Instant energization after de-energization while the capacitor discharges slowly?
- The zero-cross detection circuit of the mainboard is defined abnormal?

Malfunction diagnosis process:

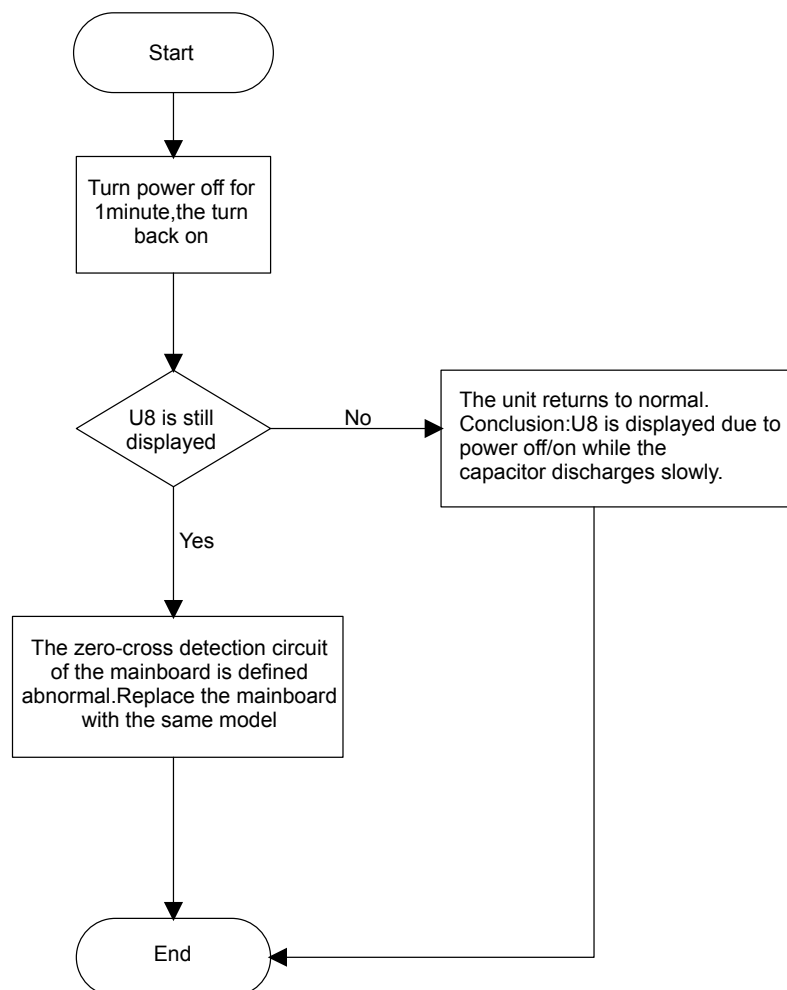

7. Malfunction of detecting plate(WIFI) JF

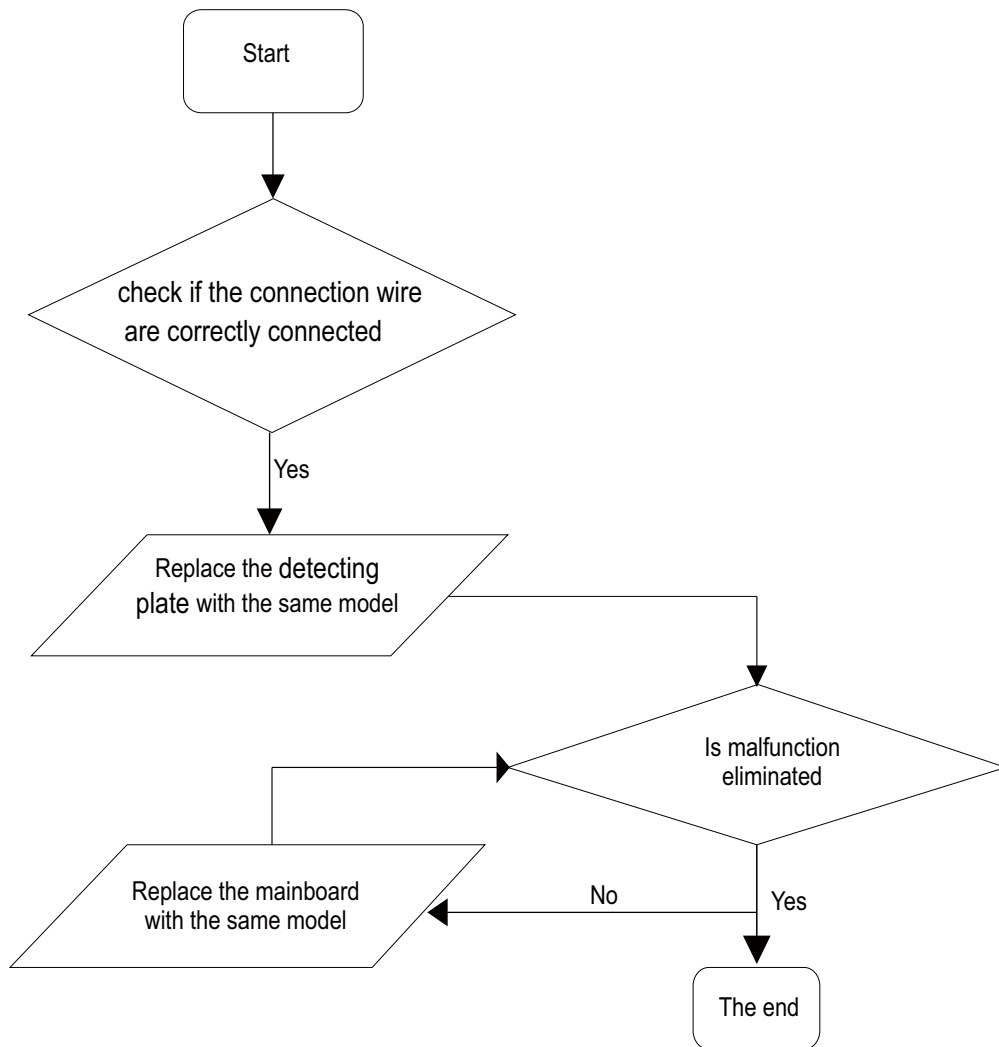

Outdoor Unit

1. Capacity charging malfunction (outdoor unit malfunction) (AP1 below means control board of outdoor unit)

Main detection points:

- Detect if the voltage of L and N terminal of XT wiring board is between 210VAC-240VAC by alternating voltage meter;
- Is reactor (L) well connected? Is connection wire loosened or pulled out? Is reactor (L) damaged?

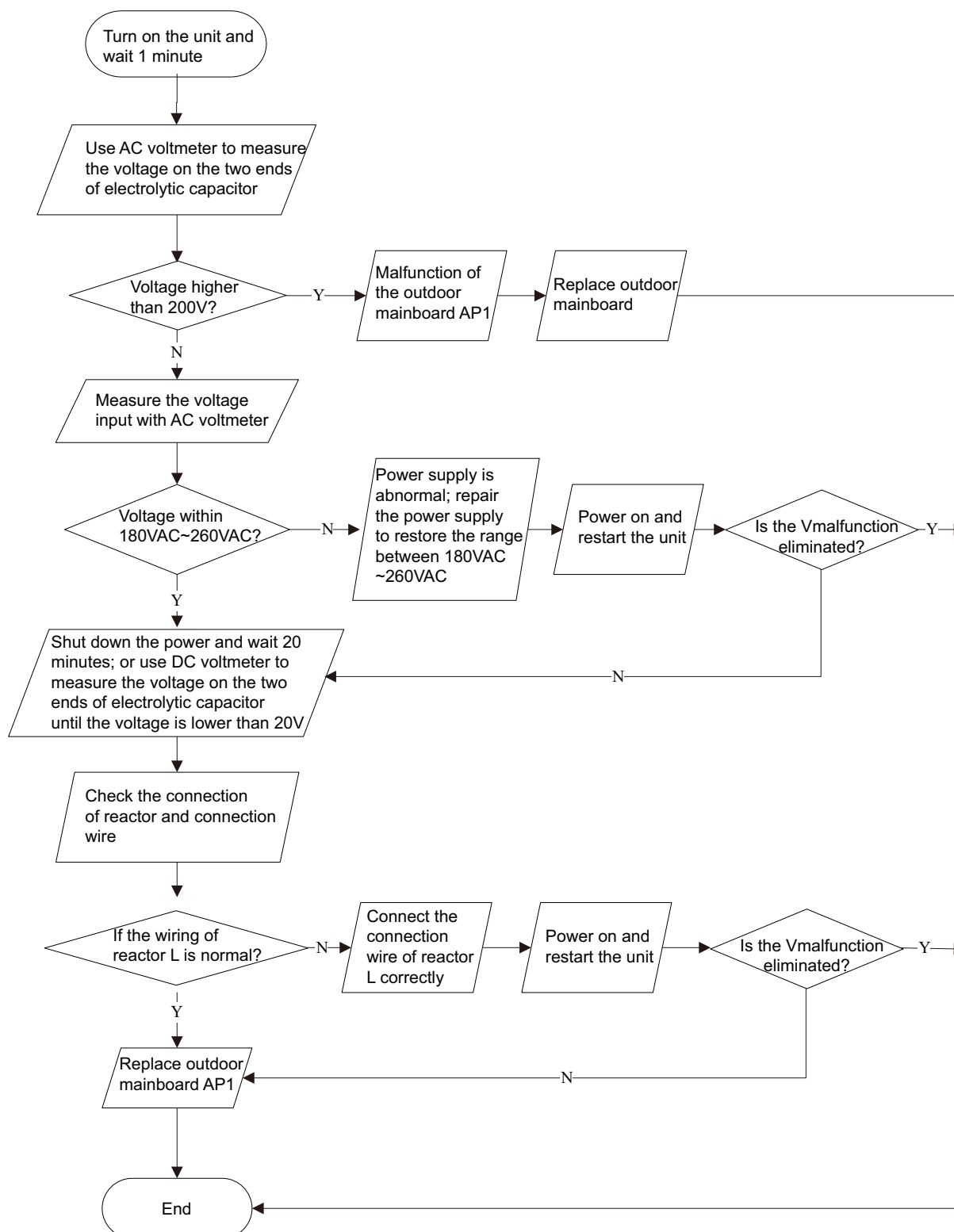

## 2. IPM protection, phase current overcurrent (the control board as below indicates the control board of outdoor unit) H5/P5

Mainly detect:

- (1) Compressor COMP terminal (2) voltage of power supply (3) compressor
- (4) Refrigerant-charging volume (5) air outlet and air inlet of outdoor/indoor unit

Troubleshooting:

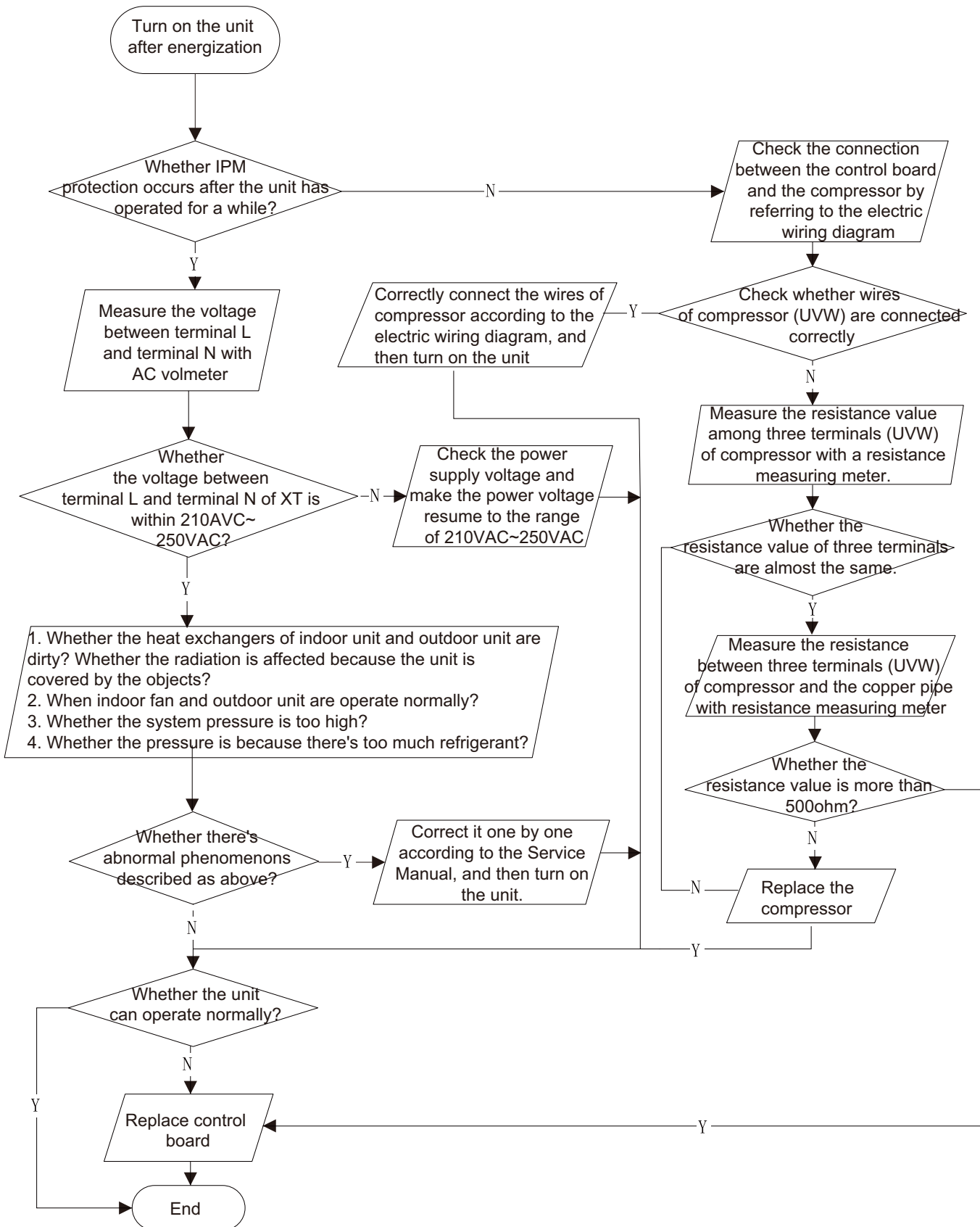

### 3. High temperature and overload protection (E8)(AP1 below means control board of outdoor unit)

Main detection points:

- If the outdoor ambient temperature is in normal range;
- If the indoor and outdoor fan are running normally;
- If the radiating environment of indoor and outdoor unit is good.

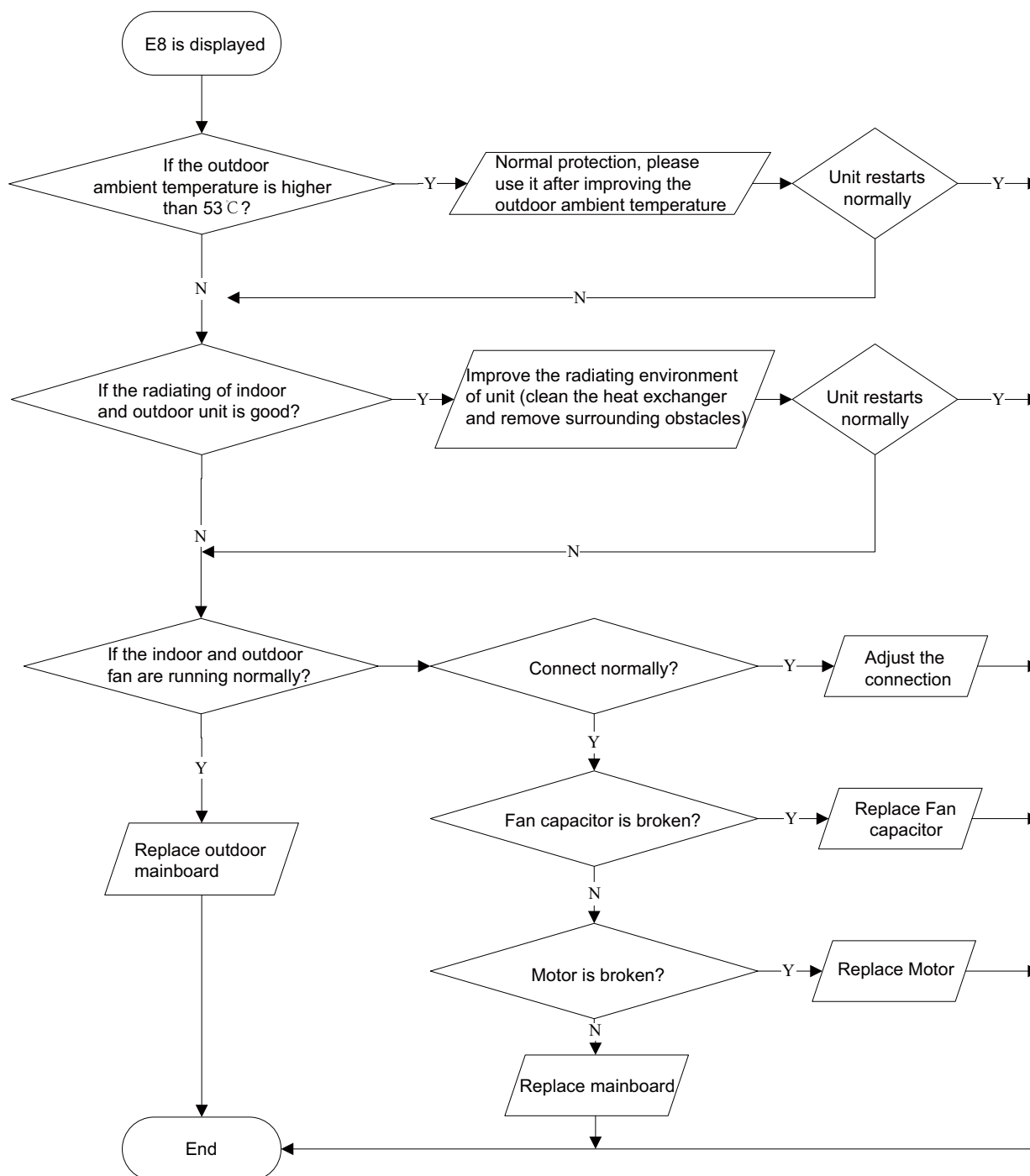

4. Start-up failure (LC) (AP1 below means control board of outdoor unit)

Main detection points:

- If the compressor wiring is correct?
- If the stop time of compressor is sufficient?
- If the compressor is damaged?
- If the refrigerant charging amount is too much?

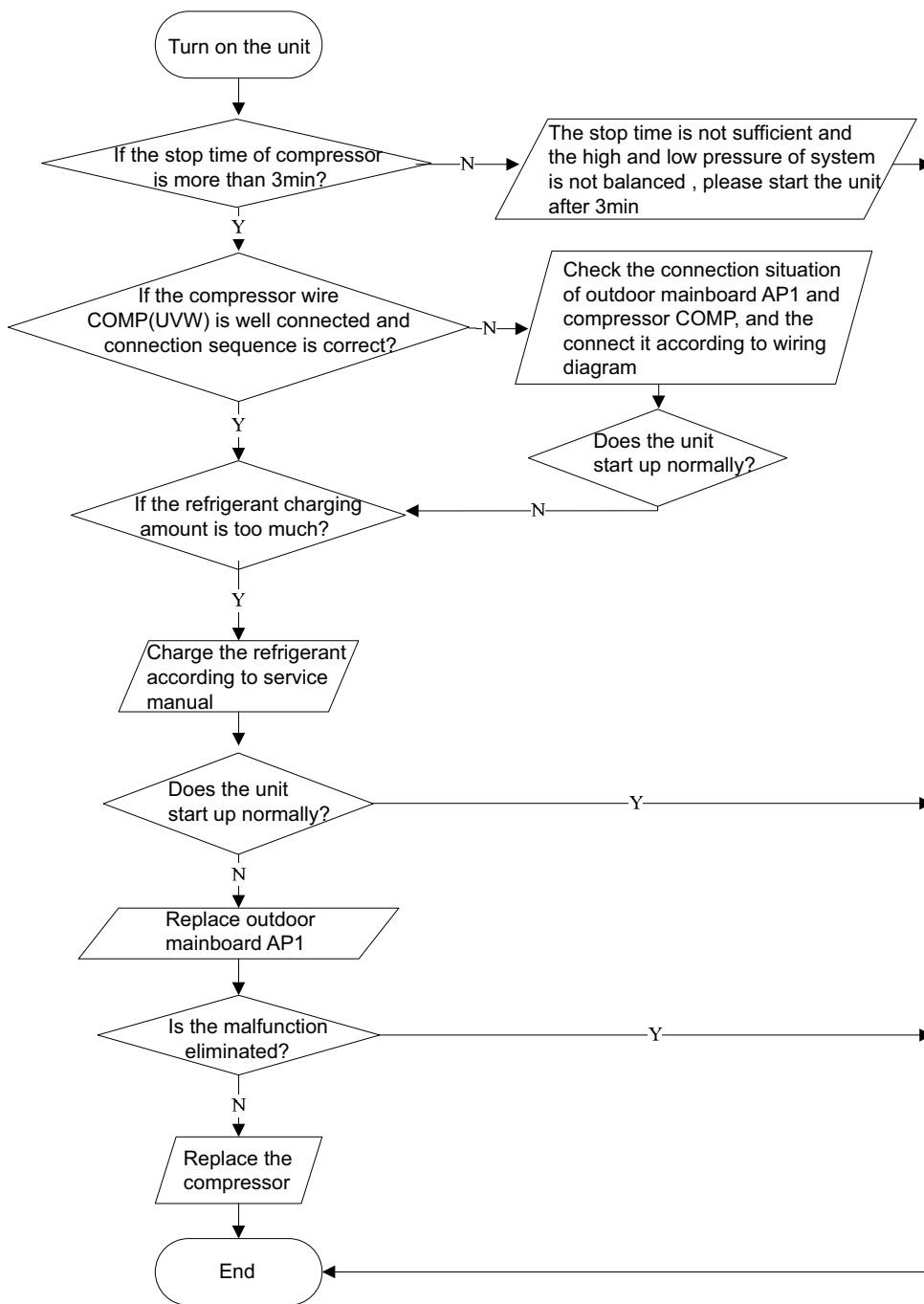



## 5. Overload and high discharge temperature malfunction

Main detection points:

- If the electronic expansion valve is connected well? Is the electronic expansion valve damaged?
- If the refrigerant is leaked?
- The compressor overload protection terminal is not connected well with the mainboard?
- If the overload protector is damaged?
- Heat exchange of unit is not good? (heat exchanger is dirty and unit radiating environment is bad)
- Too much load of the system causes high temperature of compressor after working for a long time?
- Malfunction of discharge temperature sensor?

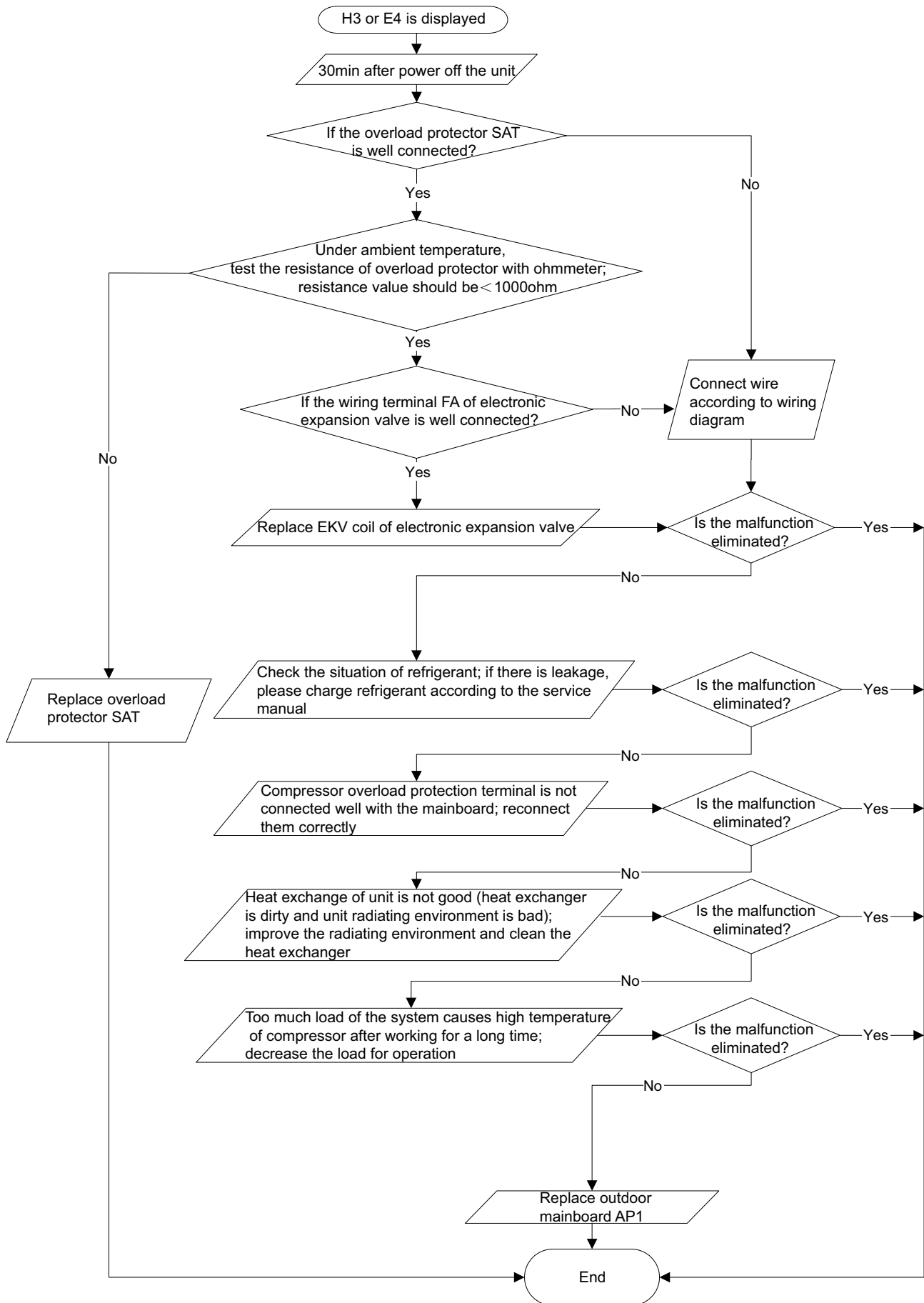

### 6. Communication malfunction (E6)

Main detection points:

- Check if the connection wire and the built-in wiring of indoor and outdoor unit are connected well and without damage;
- If the communication circuit of indoor mainboard is damaged? If the communication circuit of outdoor mainboard (AP1) is damaged?

Malfunction diagnosis process:

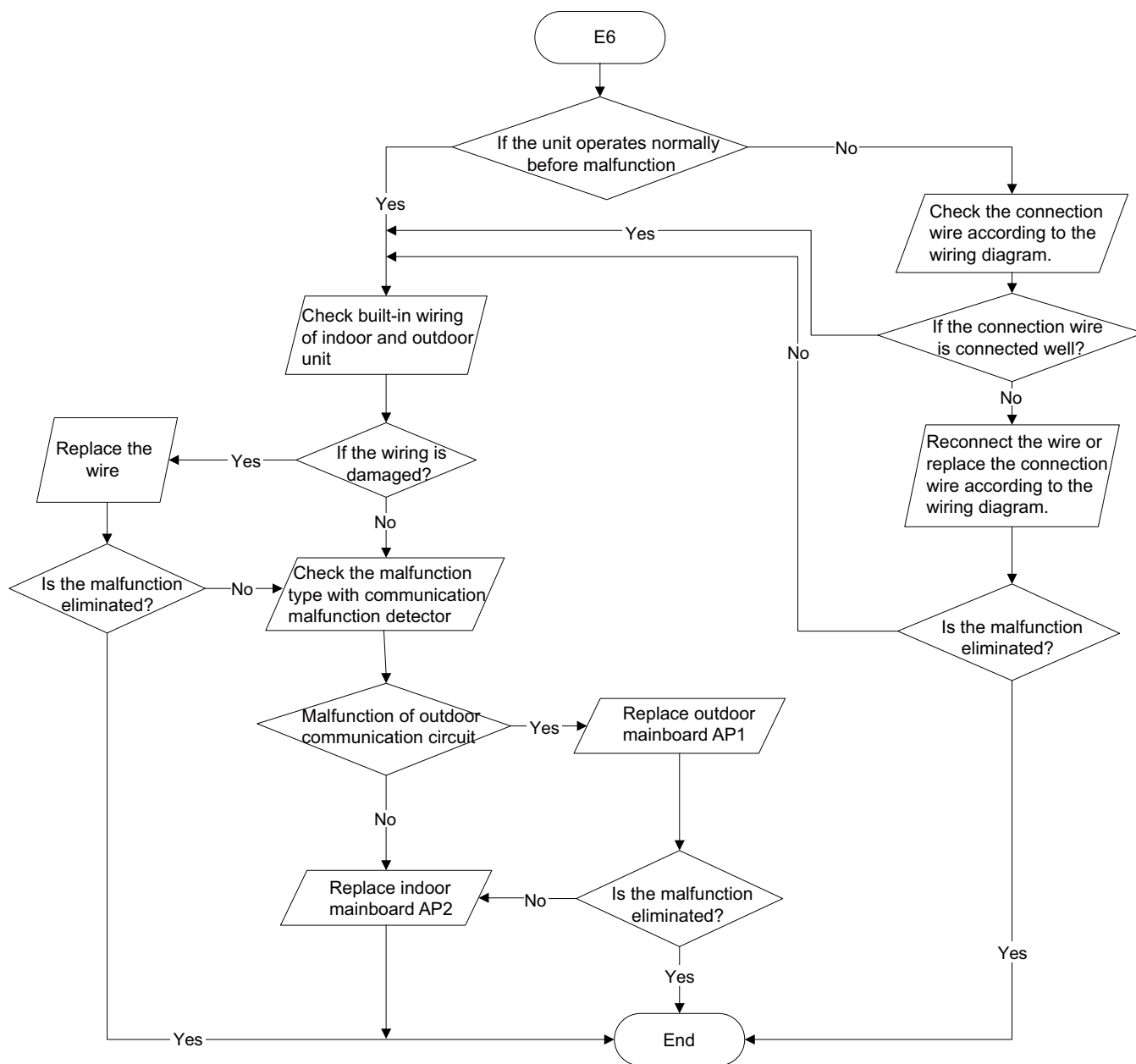

## 9.3 Troubleshooting for Normal Malfunction

### 1. Air Conditioner Cant be Started Up

Possible Causes	Discriminating Method (Air conditioner Status)	Troubleshooting
No power supply, or poor connection for power plug	After energization, operation indicator isnt bright and the buzzer cant give out sound	Confirm whether its due to power failure. If yes, wait for power recovery. If not, check power supply circuit and make sure the power plug is connected well.
Wrong wire connection between indoor unit and outdoor unit, or poor connection for wiring terminals	Under normal power supply circumstances, operation indicator isnt bright after energization	Check the circuit according to circuit diagram and connect wires correctly. Make sure all wiring terminals are connected firmly
Electric leakage for air conditioner	After energization, room circuit breaker trips off at once	Make sure the air conditioner is grounded reliably Make sure wires of air conditioner is connected correctly Check the wiring inside air conditioner. Check whether the insulation layer of power cord is damaged; if yes, place the power cord.
Model selection for air switch is improper	After energization, air switch trips off	Select proper air switch
Malfunction of remote controller	After energization, operation indicator is bright, while no display on remote controller or buttons have no action.	Replace batteries for remote controller Repair or replace remote controller

### 2. Poor Cooling (Heating) for Air Conditioner

Possible Causes	Discriminating Method (Air conditioner Status)	Troubleshooting
Set temperature is improper	Observe the set temperature on remote controller	Adjust the set temperature
Rotation speed of the IDU fan motor is set too low	Small wind blow	Set the fan speed at high or medium
Filter of indoor unit is blocked	Check the filter to see its blocked	Clean the filter
Installation position for indoor unit and outdoor unit is improper	Check whether the installation position is proper according to installation requirement for air conditioner	Adjust the installation position, and install the rainproof and sunproof for outdoor unit
Refrigerant is leaking	Discharged air temperature during cooling is higher than normal discharged wind temperature; Discharged air temperature during heating is lower than normal discharged wind temperature; Units pressure is much lower than regulated range	Find out the leakage causes and deal with it. Add refrigerant.
Malfunction of 4-way valve	Blow cold wind during heating	Replace the 4-way valve
Malfunction of capillary	Discharged air temperature during cooling is higher than normal discharged wind temperature; Discharged air temperature during heating is lower than normal discharged wind temperature; Unit pressure is much lower than regulated range. If refrigerant isnt leaking, part of capillary is blocked	Replace the capillary
Flow volume of valve is insufficient	The pressure of valves is much lower than that stated in the specification	Open the valve completely
Malfunction of horizontal louver	Horizontal louver cant swing	Refer to point 3 of maintenance method for details
Malfunction of the IDU fan motor	The IDU fan motor cant operate	Refer to troubleshooting for H6 for maintenance method in details
Malfunction of the ODU fan motor	The ODU fan motor cant operate	Refer to point 4 of maintenance method for details
Malfunction of compressor	Compressor cant operate	Refer to point 5 of maintenance method for details

### 3. Horizontal Louver Cant Swing

Possible Causes	Discriminating Method (Air conditioner Status)	Troubleshooting
Wrong wire connection, or poor connection	Check the wiring status according to circuit diagram	Connect wires according to wiring diagram to make sure all wiring terminals are connected firmly
Stepping motor is damaged	Stepping motor cant operate	Repair or replace stepping motor
Main board is damaged	Others are all normal, while horizontal louver cant operate	Replace the main board with the same model

**4. ODU Fan Motor Cant Operate**

Possible causes	Discriminating method (air conditioner status)	Troubleshooting
Wrong wire connection, or poor connection	Check the wiring status according to circuit diagram	Connect wires according to wiring diagram to make sure all wiring terminals are connected firmly
Capacity of the ODU fan motor is damaged	Measure the capacity of fan capacitor with an universal meter and find that the capacity is out of the deviation range indicated on the nameplate of fan capacitor.	Replace the capacity of fan
Power voltage is a little low or high	Use universal meter to measure the power supply voltage. The voltage is a little high or low	Suggest to equip with voltage regulator
Motor of outdoor unit is damaged	When unit is on, cooling/heating performance is bad and ODU compressor generates a lot of noise and heat.	Change compressor oil and refrigerant. If no better, replace the compressor with a new one

**5. Compressor Cant Operate**

Possible causes	Discriminating method (air conditioner status)	Troubleshooting
Wrong wire connection, or poor connection	Check the wiring status according to circuit diagram	Connect wires according to wiring diagram to make sure all wiring terminals are connected firmly
Capacity of compressor is damaged	Measure the capacity of fan capacitor with an universal meter and find that the capacity is out of the deviation range indicated on the nameplate of fan capacitor.	Replace the compressor capacitor
Power voltage is a little low or high	Use universal meter to measure the power supply voltage. The voltage is a little high or low	Suggest to equip with voltage regulator
Coil of compressor is burnt out	Use universal meter to measure the resistance between compressor terminals and its 0	Repair or replace compressor
Cylinder of compressor is blocked	Compressor cant operate	Repair or replace compressor

**6. Air Conditioner is Leaking**

Possible causes	Discriminating method (air conditioner status)	Troubleshooting
Drain pipe is blocked	Water leaking from indoor unit	Eliminate the foreign objects inside the drain pipe
Drain pipe is broken	Water leaking from drain pipe	Replace drain pipe
Wrapping is not tight	Water leaking from the pipe connection place of indoor unit	Wrap it again and bundle it tightly

**7. Abnormal Sound and Vibration**

Possible causes	Discriminating method (air conditioner status)	Troubleshooting
When turn on or turn off the unit, the panel and other parts will expand and theres abnormal sound	Theres the sound of "PAPA"	Normal phenomenon. Abnormal sound will disappear after a few minutes.
When turn on or turn off the unit, theres abnormal sound due to flow of refrigerant inside air conditioner	Water-running sound can be heard	Normal phenomenon. Abnormal sound will disappear after a few minutes.
Foreign objects inside the indoor unit or therere parts touching together inside the indoor unit	Theres abnormal sound fro indoor unit	Remove foreign objects. Adjust all parts position of indoor unit, tighten screws and stick damping plaster between connected parts
Foreign objects inside the outdoor unit or therere parts touching together inside the outdoor unit	Theres abnormal sound fro outdoor unit	Remove foreign objects. Adjust all parts position of outdoor unit, tighten screws and stick damping plaster between connected parts
Short circuit inside the magnetic coil	During heating, the way valve has abnormal electromagnetic sound	Replace magnetic coil
Abnormal shake of compressor	Outdoor unit gives out abnormal sound	Adjust the support foot mat of compressor, tighten the bolts
Abnormal sound inside the compressor	Abnormal sound inside the compressor	If add too much refrigerant during maintenance, please reduce refrigerant properly. Replace compressor for other circumstances.



NO.	Description
1	Front Panel Sub-Assy
2	Stand Bar
3	Screw Cover
4	Cover Plate
5	Left Decorative Board
6	Left Side Plate
7	Left Driving Box Sub-assy
8	Front Case Assy
9	Decorative Strip (Up)
10	Swing Lever
11	Air Louver (left)
12	Filter Sub-Assy
13	Ring of Bearing
14	O-Gasket sub-assy of Bearing
15	Cross Flow Fan
16	Drainage Hose
17	Evaporator Support
18	Evaporator Assy
19	Breakwater
20	Cold Plasma Generator
21	Motor Press Plate
22	Fan Motor
23	Connecting pipe clamp
24	Wall Mounting Frame
25	Jumper
26	Main Board
27	Mouseproof Board
28	Shield Cover of Electric Box Sub-assy
29	Electric Box Assy
30	Rear Case assy
31	Helicoid Tongue sub-assy
32	Helicoid Tongue
33	Louver Motor Sub-assy (Left and Right)
34	Crank 1
35	Air Louver(right)
36	Right Side Plate
37	Right Decorative Board
38	Right Driving Box Sub-assy
39	Electric Box Cover Sub-Assy
40	Display Board
41	Detecting Plate
42	Front Panel
43	Front Panel
44	Guide Louver
45	Remote Controller
46	Filter (antimicrobial)
47	Temperature Sensor
48	Temperature Sensor
49	Detecting plate(WIFI)
50	Stepping Motor
51	Stepping Motor
52	Stepping Motor
53	Stepping Motor
54	Terminal Board

Some models may not contain some parts, please refer to the actual product.

GWH18UC-K6DNA4A/I

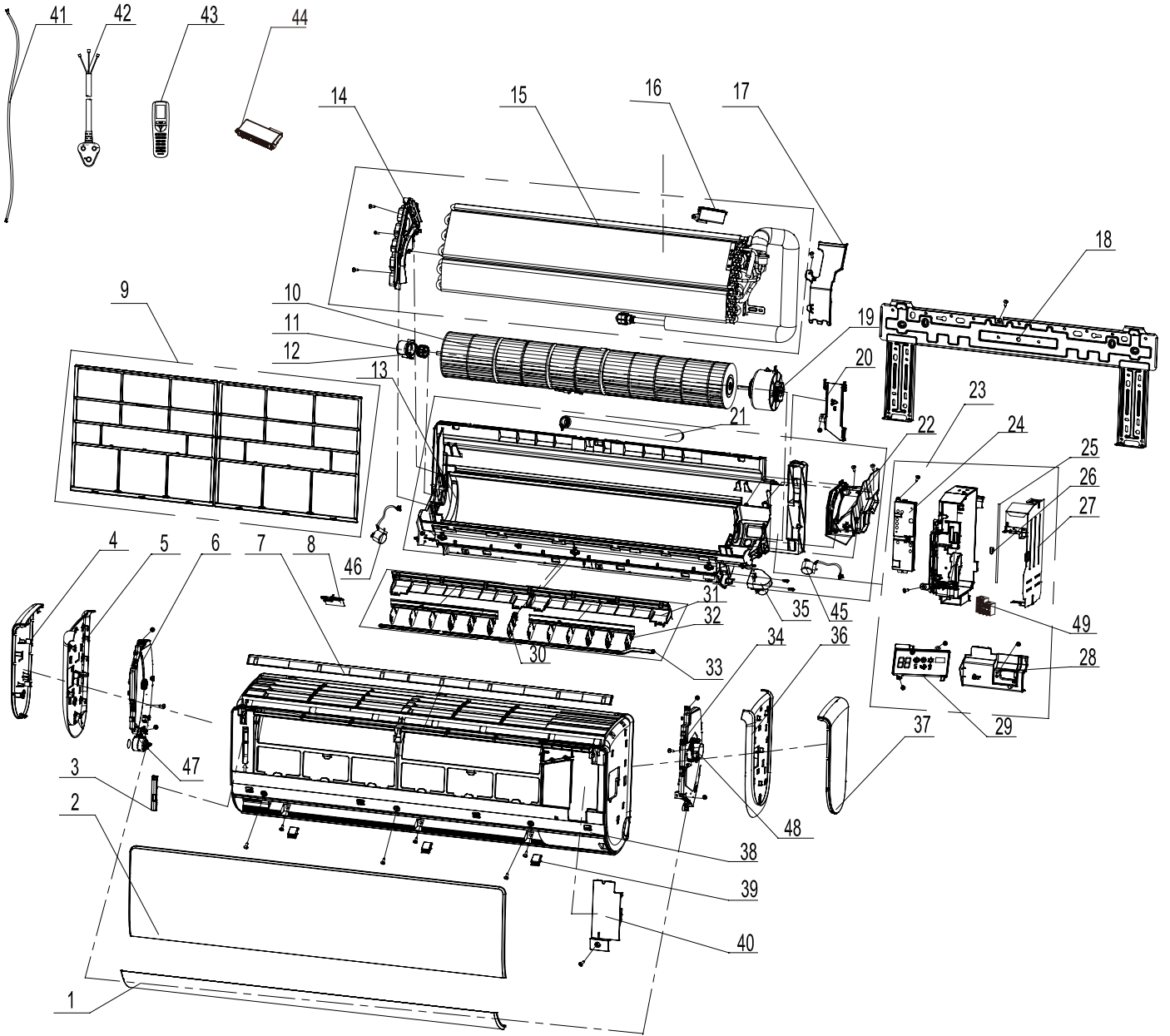

The component picture is only for reference; please refer to the actual product.



NO.	Description
1	Guide Louver
2	Front Panel
3	Stand Bar
4	Left Side Plate
5	Left Decorative Board
6	Left Driving Box Sub-assy
7	Decorative Strip (Up)
8	Cover plate(Air Outlet)
9	Filter Sub-Assy
10	Cross Flow Fan
11	Ring of Bearing
12	O-Gasket sub-assy of Bearing
13	Rear Case
14	Evaporator Support
15	Evaporator Assy
16	Cold Plasma Generator
17	Breakwater
18	Wall Mounting Frame
19	Fan Motor
20	Connecting pipe clamp
21	Drainage Hose
22	Motor Press Plate
23	Electric Box Assy
24	Detecting Plate
25	Main Board
26	Jumper
27	Shield Cover of Electric Box Sub-assy
28	Mouseproof Board
29	Display Board
30	Air Louver (Middle)
31	Helicoid Tongue
32	Air Louver
33	Swing Lever
34	Right Driving Box Sub-assy
35	Louver Motor Sub-assy (Left and Right)
36	Right Decorative Board
37	Right Side Plate
38	Front Case
39	Screw Cover
40	Electric Box Cover Sub-Assy
41	Connecting Cable
42	Power Cord
43	Remote Controller
44	Detecting plate(WIFI)
45	Stepping Motor
46	Stepping Motor
47	Stepping Motor
48	Stepping Motor
49	Terminal Board

Some models may not contain some parts, please refer to the actual product.



No.	Description
1	Front Grill
2	Cabinet
3	Brushless DC Motor
4	Clapboard Sub-Assy
5	Chassis Sub-assy
6	Compressor and Fittings
7	Valve Support Sub-Assy
8	Cut-off valve 1/4(N)
9	Cut-off valve 3/8(N)
10	Valve Cover
11	Left Side Plate
12	4-Way Valve Assy
13	Filtering Sub-Assy
14	Condenser Assy
15	Fixed Mount
16	Flash Vaporizer Assy
17	Coping
18	Main Board
19	Electric Box Assy
20	Motor Support Sub-Assy
21	Left Side Plate
22	Axial Flow Fan
23	Valve Cover
24	Terminal Board
25	Wire Clamp
26	Wire Clamp
27	Compressor Gasket

Some models may not contain some parts, please refer to the actual product.

GWH18UC-K6DNA4A/O

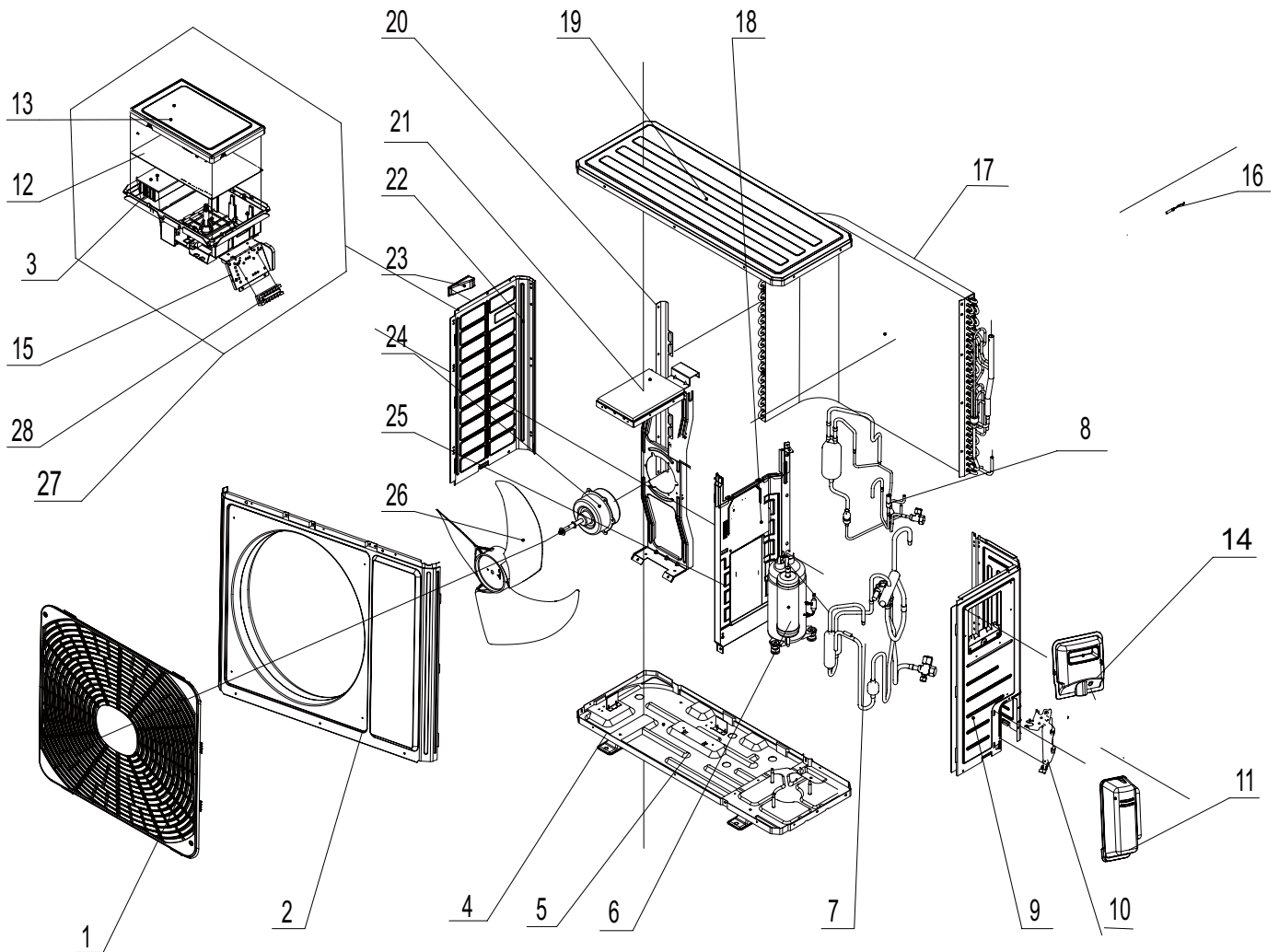

The component picture is only for reference; please refer to the actual product.



No.	Description
1	Front Grill
2	Front Panel
3	Radiator
4	Chassis Sub-assy
5	Electrical Heater (Chassis)
6	Compressor and Fittings
7	4-Way Valve Assy
8	Electronic Expansion Valve assy
9	Right Side Plate
10	Valve Support Sub-Assy
11	Valve Cover
12	Main Board
13	Electric Box Cover
14	Big Handle
15	Terminal Board Support sub-assy
16	Temperature Sensor
17	Condenser Assy
18	Motor Support Sub-Assy
19	Top Cover Sub-Assy
20	Condenser Support Plate
21	Motor Support Assy
22	Left Side Plate
23	Left Handle
24	Fan Motor
25	Clapboard Sub-Assy
26	Axial Flow Fan
27	Electric Box Assy
28	Terminal Board

Some models may not contain some parts, please refer to the actual product.

## 11. Removal Procedure

 **Caution:** discharge the refrigerant completely before removal.

### 11.1 Removal Procedure of Indoor Unit

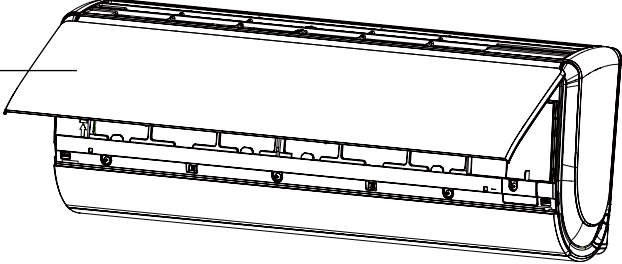
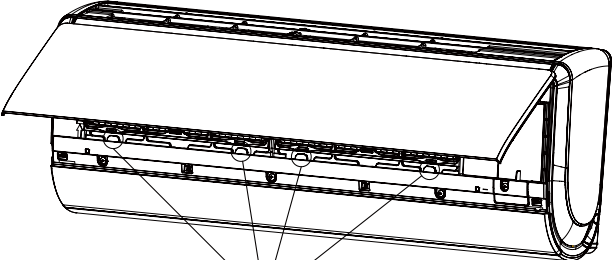
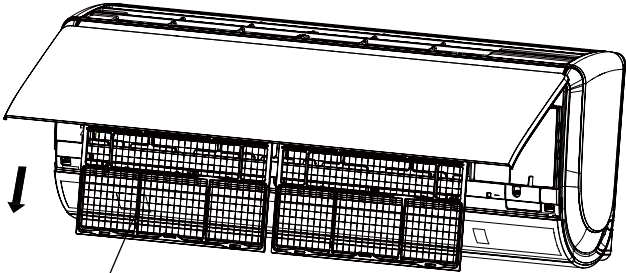
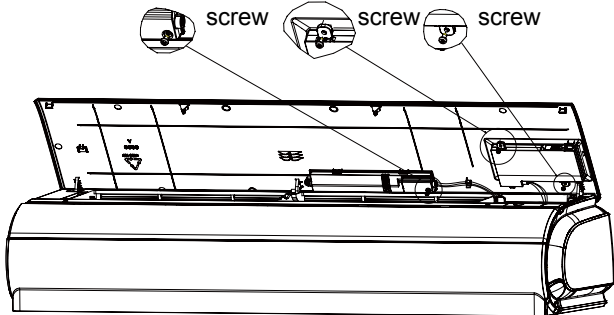
Steps	Procedure	
1. Remove filter sub-assy		
a	Open the panel.	 <p>panel</p>
b	Remove clasps on filter.	 <p>clasp</p>
c	Remove filter sub-assy with hand.	 <p>filter sub-assy</p>
2. Remove panel		
a	Remove 3 screws on sealing cover of panel and display with screwdriver.	 <p>screw screw screw</p>

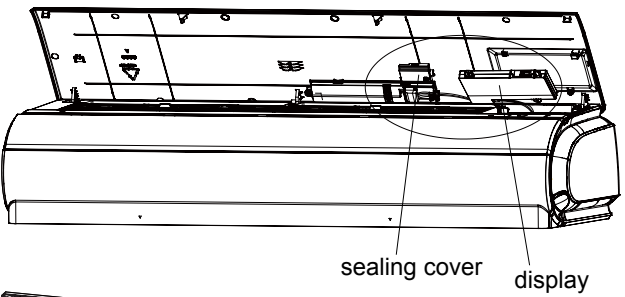
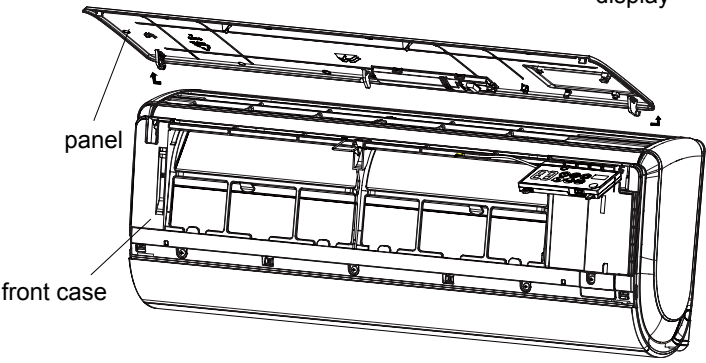
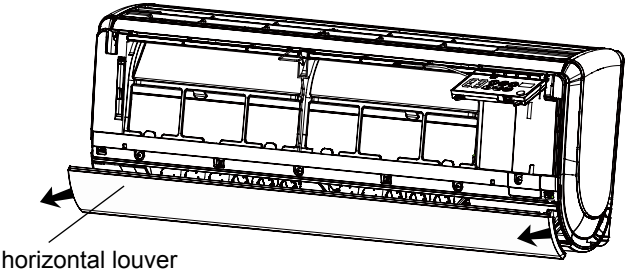
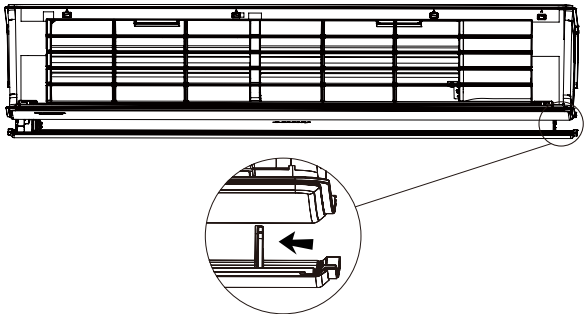
Steps	Procedure	
<p>b</p> <p>Remove sealing cover and display.</p>		 <p>sealing cover</p> <p>display</p>
<p>c</p> <p>Remove hinges at both sides of panel to separate panel and front case and then remove the panel.</p>		 <p>panel</p> <p>front case</p>
<p>3. Remove horizontal louver and front case</p>		
<p>a</p> <p>Cut off power, hold both ends of horizontal louver with hand, and then draw it out horizontally.</p>		 <p>horizontal louver</p>
<p>b</p> <p>Remove right end at first. Hold the right end of horizontal louver, push the connection rod with thumb to separate the connection rod and horizontal louver.</p>		

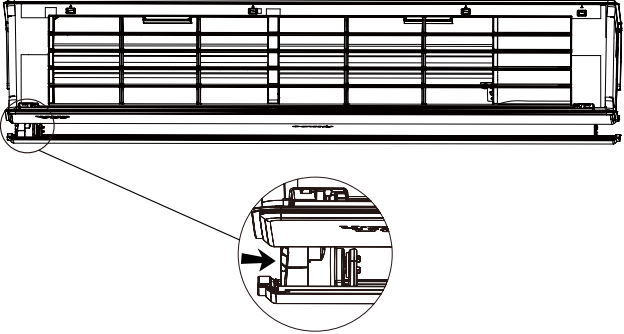
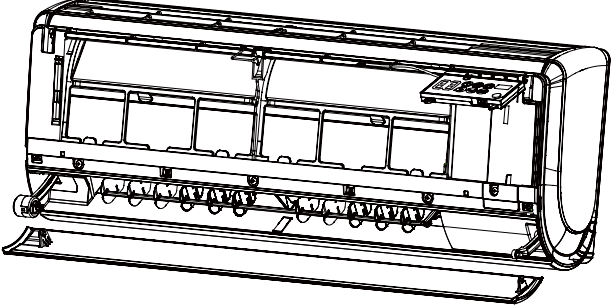
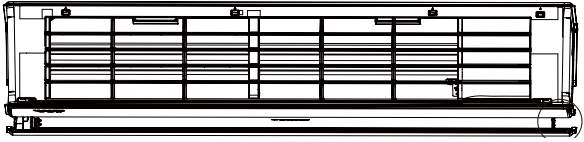
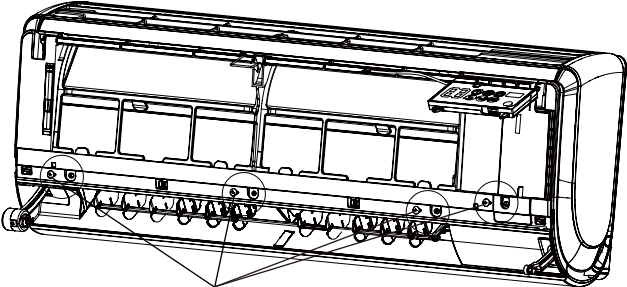
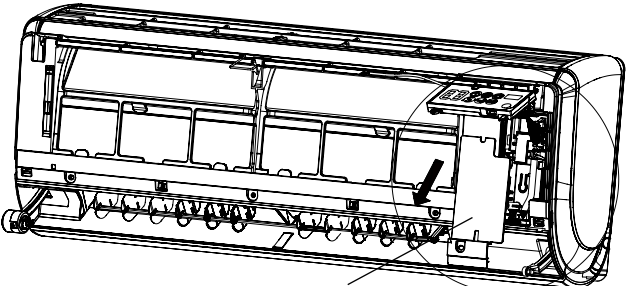
Steps		Procedure
c	<p>Remove the left end. Hold the end of connection rod with left hand, hold the horizontal louver with right hand to separate connection rod and horizontal louver.</p>	
d	<p>Remove the horizontal louver along the axle center direction.</p>	
e	<p>Note: (during operation, install the left end and then install the right end. After installation, re-energize the unit until the horizontal louver is reset. After that, you can operate the unit).</p>	
f	<p>Remove 4 screws on front case and electric box cover with screwdriver.</p>	 <p>screws</p>
g	<p>Remove electric box cover.</p>	 <p>electric box cover</p>

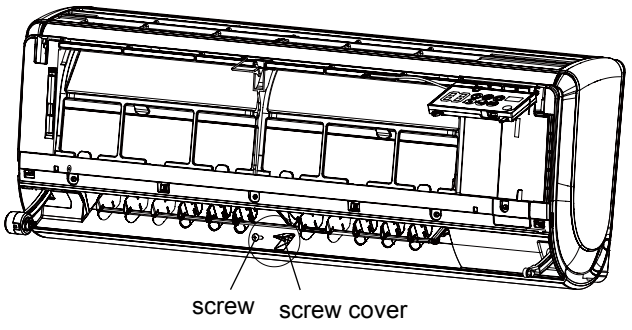
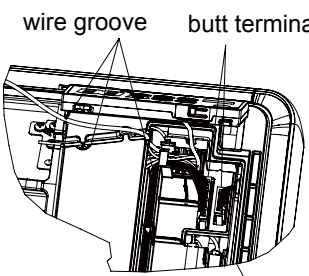
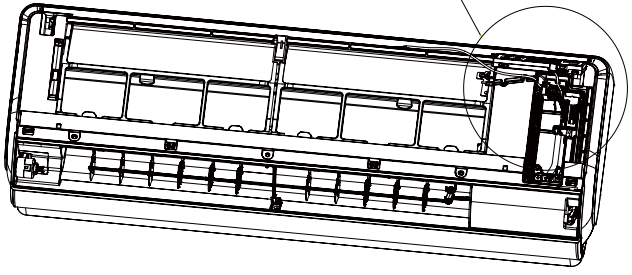
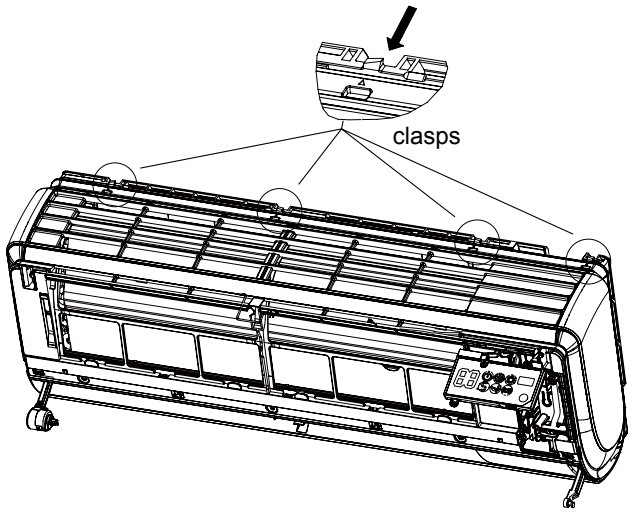

Steps	Procedure	Procedure
h	Turn over the screw cover on front case with hand, and then remove one screw inside the screw cover with screwdriver.	 
i	Pull out two butt terminals on electric box, and then take out connection wire of butt terminal, connection wire of inspection board and wire of temperature sensor from the wire groove.	
j	Open 4 clasps at left, middle and right side of front case with hand.	



b Remove screws fixing electric box with screwdriver, and then take out the wires from the wire groove of electric box with hand.

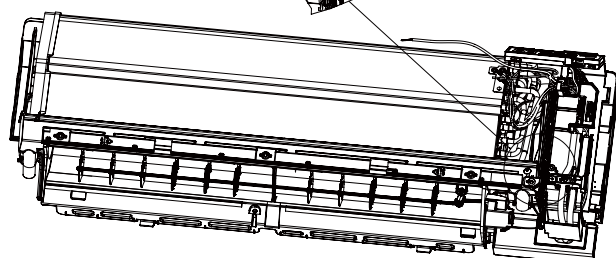
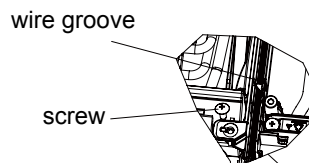

c Remove screw from press plate of connection pipe with screwdriver.

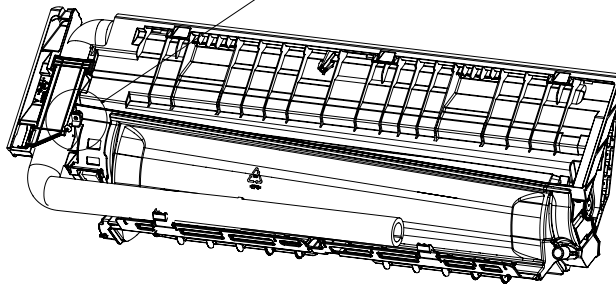
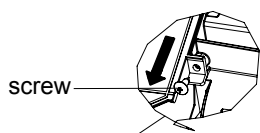

d Remove press plate of connection pipe with hand to separate it from the bottom case.

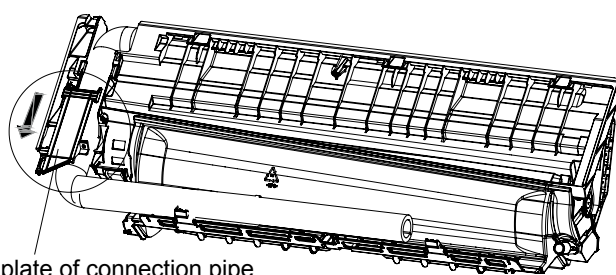

e Remove 2 screws at the connection position of evaporator and bottom case with screwdriver.

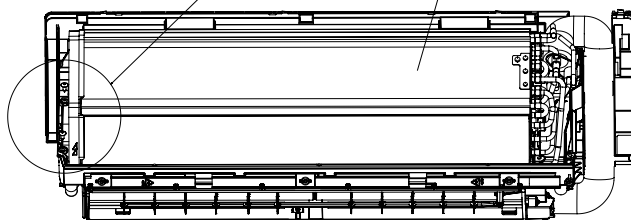
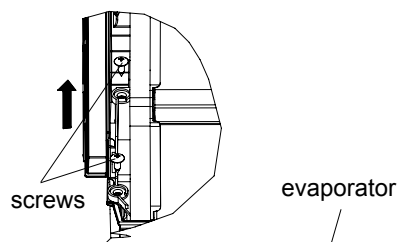

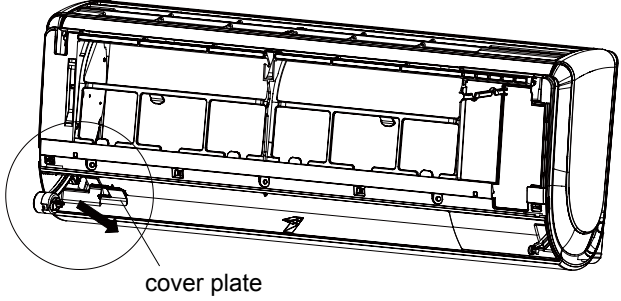
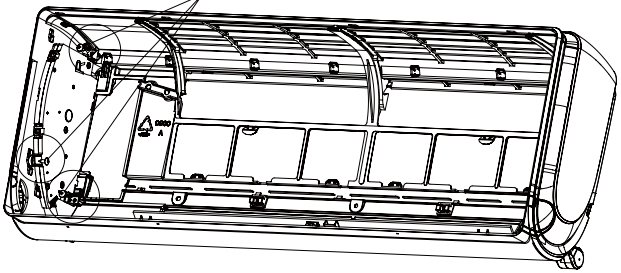
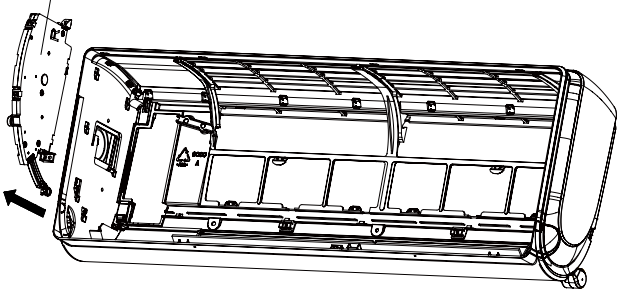
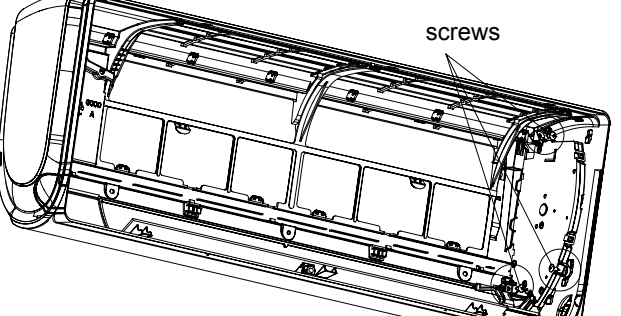
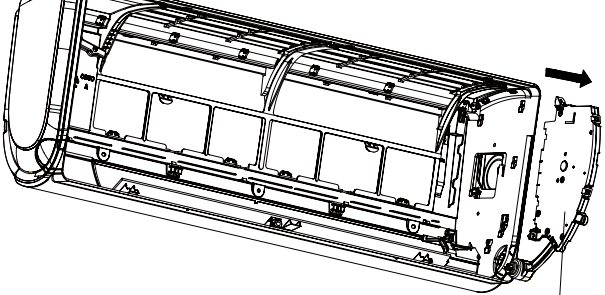

Steps	Procedure	Diagram
<p>c</p> <p>Remove swing motor sub-assy.</p>		<p>swing motor sub-assy</p> <p>swing connection rod</p>
<p>7. Remove cross flow blade and motor</p>		
<p>a</p> <p>Remove 4 screws fixing the motor press plate with screwdriver.</p>		<p>screws</p>
<p>b</p> <p>Take out the motor press plate.</p>		<p>motor press plate</p>
<p>c</p> <p>Take out cross flow blade and motor.</p>		<p>cross flow blade</p> <p>motor</p>
<p>d</p> <p>Pull out the shaft rubber cushion block with hand.</p>		<p>shaft rubber cushion block</p>

Steps	Procedure
8. Remove drive box	
a	<p>Remove the left side cover plate of front case.</p>  <p>cover plate</p>
b	<p>Remove 3 screws fixing the left drive box with screwdriver.</p>  <p>screws</p>
c	<p>Take out right drive box.</p>  <p>right drive box</p>
d	<p>Remove 3 screws fixing left drive box with screwdriver.</p>  <p>screws</p>
e	<p>Take out the left drive box.</p>  <p>left drive box</p>

## 11.2 Removal Procedure of Outdoor Unit



**Warning:** Be sure to wait for a minimum of 20 minutes after turning off all power supplies and discharge the refrigerant completely before removal.

GWH09UB-K6DNA4A/O

GWH12UB-K6DNA4A/O

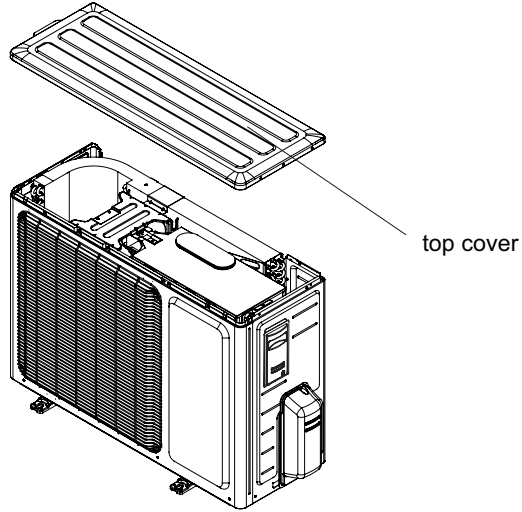
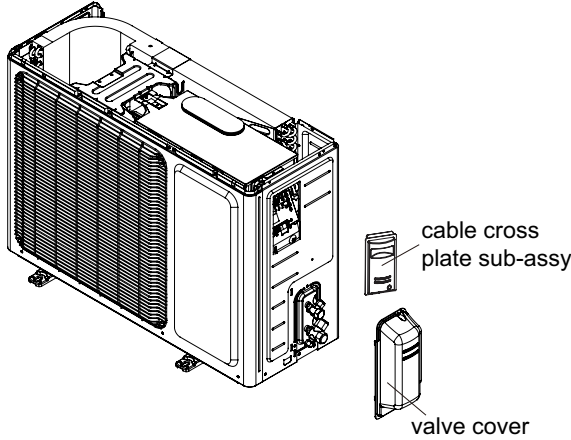
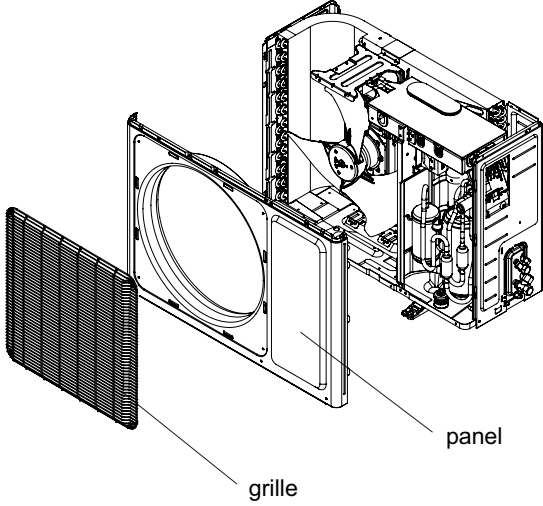
Steps	Procedure
<p>1. Remove top cover</p>	<p>Remove the screws connecting top cover, left and right side plate, as well as panel, to remove the top cover.</p>  <p>top cover</p>
<p>2. Remove cable cross plate sub-assy and valve cover</p>	<p>Remove the screws connecting cable cross plate sub-assy and right side plate, to remove the cable cross plate sub-assy. Remove the screw fixing valve cover, to remove the cover.</p>  <p>cable cross plate sub-assy</p> <p>valve cover</p>
<p>3. Remove panel and grille</p>	<p>Remove the screws fixing panel, to remove the panel. Remove the screws connecting panel grille and panel, loosen the clamp, to remove the panel grille.</p>  <p>grille</p> <p>panel</p>



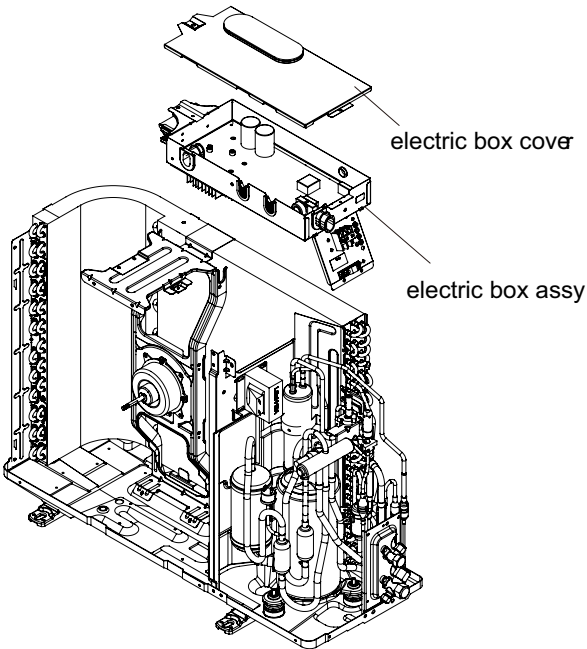
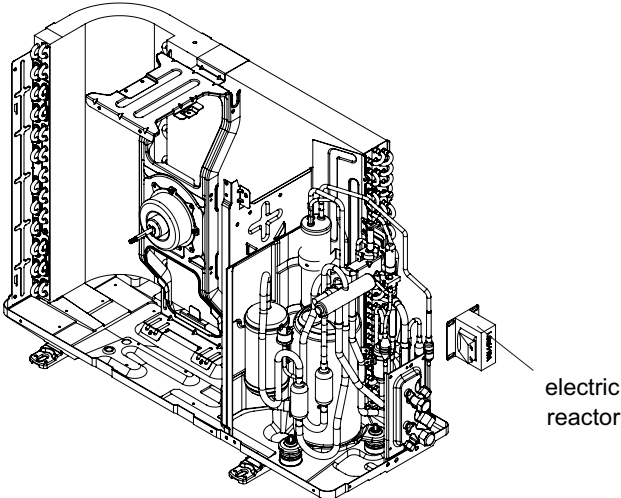
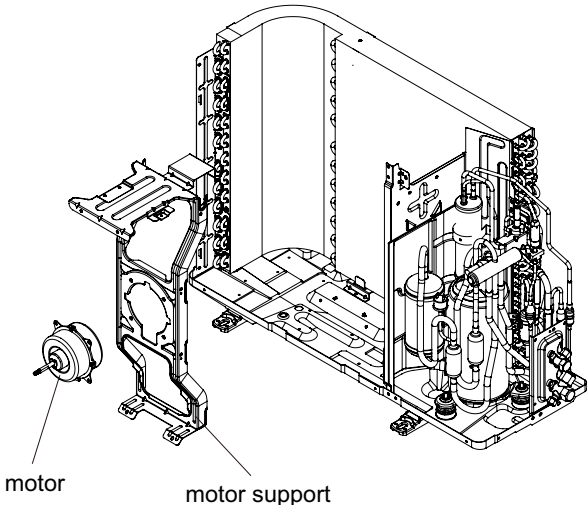

Steps	Procedure
<p>7. Remove electric box assy</p>	<p>Remove screws fixing electric box assy and mid-isolation board, loosen the bonding tie, pull off the wiring terminal, lift to remove the electric box assy.</p> 
<p>8. Remove electric reactor</p>	<p>Remove the screws fixing electric reactor, to remove the electric reactor.</p> 
<p>9. Remove motor and motor support</p>	<p>Remove the four tapping screws fixing motor, pull out the contact tag of motor wiring, to remove the motor. Remove the two tapping screws fixing motor support and chassis, lift to remove the motor support.</p> 

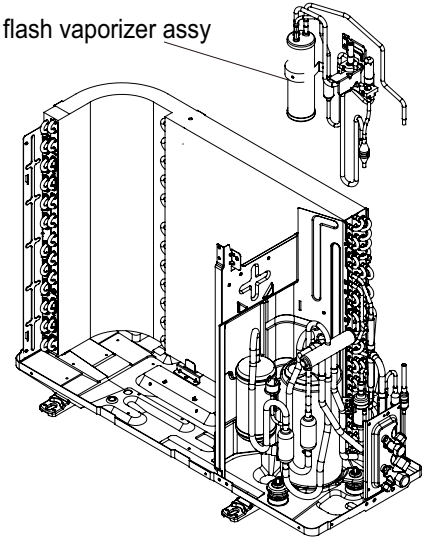
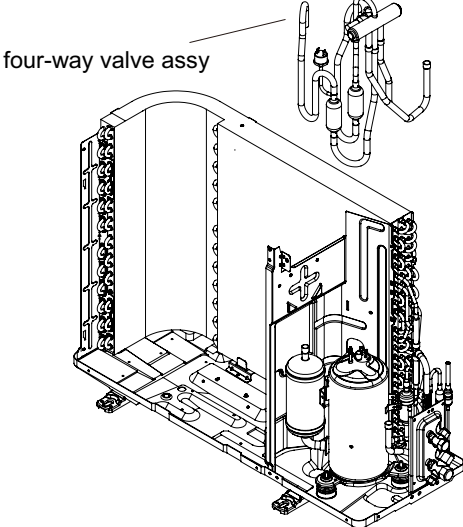
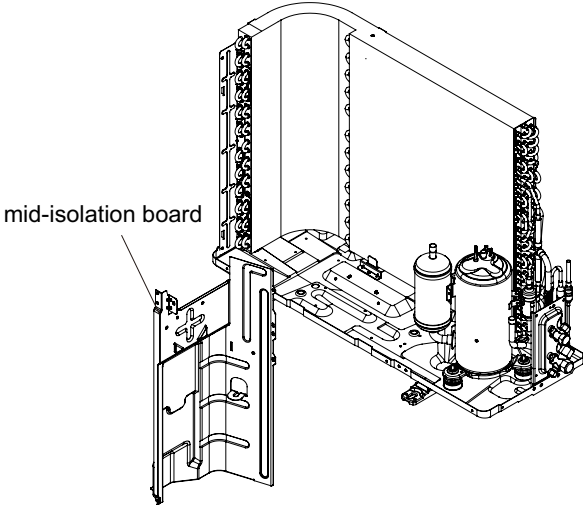
Steps	Procedure
10. Remove flash vaporizer assy	<p data-bbox="261 423 808 489">Remove the screws connecting mid-isolation board, lift to remove the flash vaporizer assy.</p> <div data-bbox="974 305 1396 840"> <p data-bbox="974 323 1185 349">flash vaporizer assy</p>  </div>
11. Remove four-way valve assy	<p data-bbox="261 1078 831 1249">Welding cut the spot weld of four-way valve assy, compressor air suction/discharging valve and condenser pipe outlet, lift to remove the four-way valve assy. (Note: release the refrigerant before welding cutting.)</p> <div data-bbox="925 895 1388 1419"> <p data-bbox="925 943 1136 969">four-way valve assy</p>  </div>
12. Remove mid-isolation board	<p data-bbox="261 1712 818 1812">Remove the screws connecting mid-isolation board, chassis and condenser assy, to remove the mid-isolation.</p> <div data-bbox="860 1463 1445 1965"> <p data-bbox="860 1664 1055 1690">mid-isolation board</p>  </div>

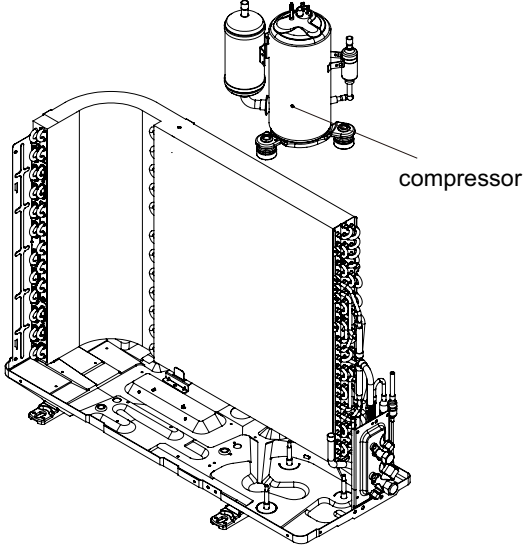
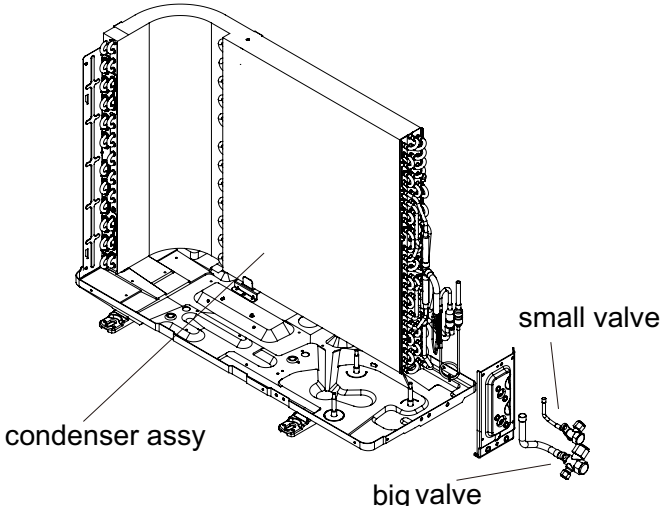
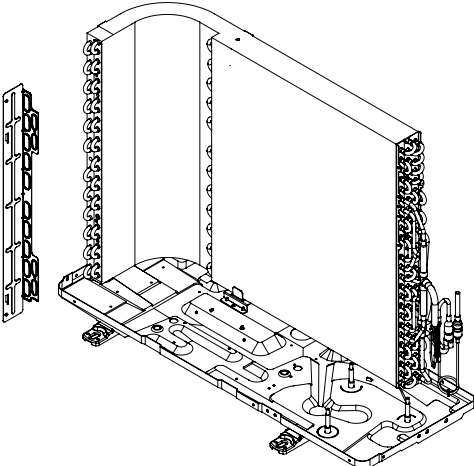
Steps	Procedure
<p>13. Remove compressor</p>	<p>Remove the three feet screwnuts fixing compressor, to remove the compressor.</p> 
<p>14. Remove big and small valve assy</p>	<p>Remove screws connecting condenser assy and chassis, to remove the condenser assy. Remove the screws fixing big and small valve, to remove the valves.</p> 
<p>15. Remove chassis sub-assy</p>	<p>Remove screws connecting condenser assy and chassis, to remove the chassis sub-assy.</p> 

GWH18UC-K6DNA4A/O

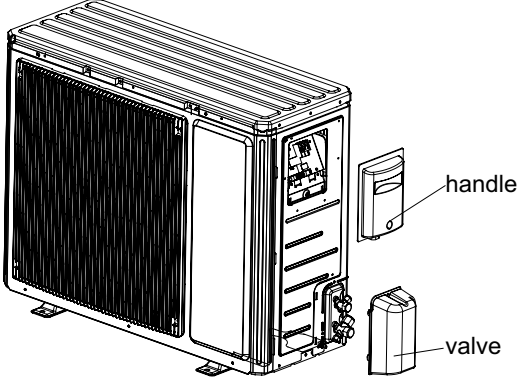
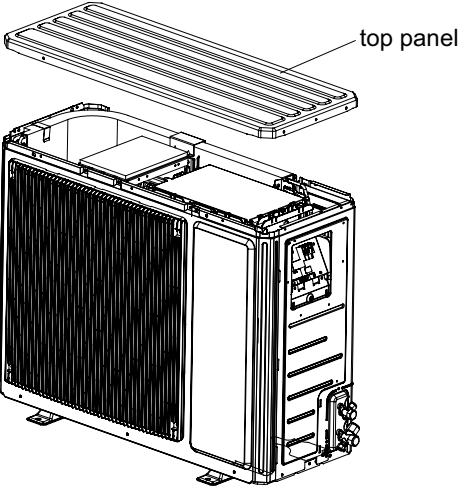
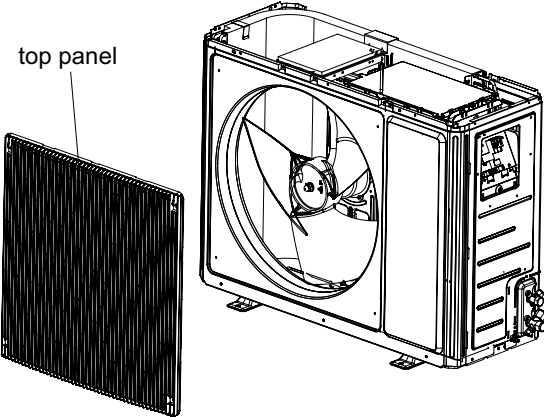
Steps	Procedure	
1. Remove top panel		
1	Twist off the screws used for fixing the handle and valve cover, pull the handle and valve cover upward to remove it.	 <p>A perspective view of the air conditioning unit with the top panel removed. Two components are shown separately to the right: a rectangular handle and a cylindrical valve cover. Labels 'handle' and 'valve' point to these components.</p>
2	Remove the 3 screws connecting the top panel with the front panel and the right side plate, and then remove the top panel.	 <p>A perspective view of the air conditioning unit with the top panel being lifted away. The top panel is shown above the unit, with a label 'top panel' pointing to it.</p>
2. Remove grille , panel and rear grill		
1	Remove the 2 screws connecting the grille and the panel, and then remove the grille.	 <p>A perspective view of the air conditioning unit with the top panel removed. A rectangular grille is shown to the left of the unit, with a label 'top panel' pointing to it. The grille is being removed from the front panel.</p>

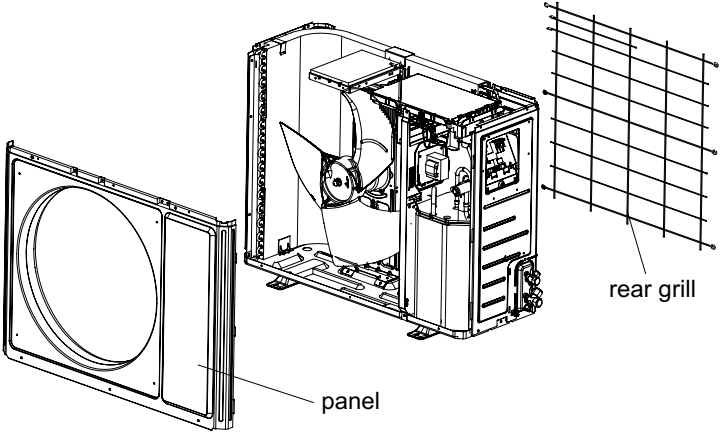
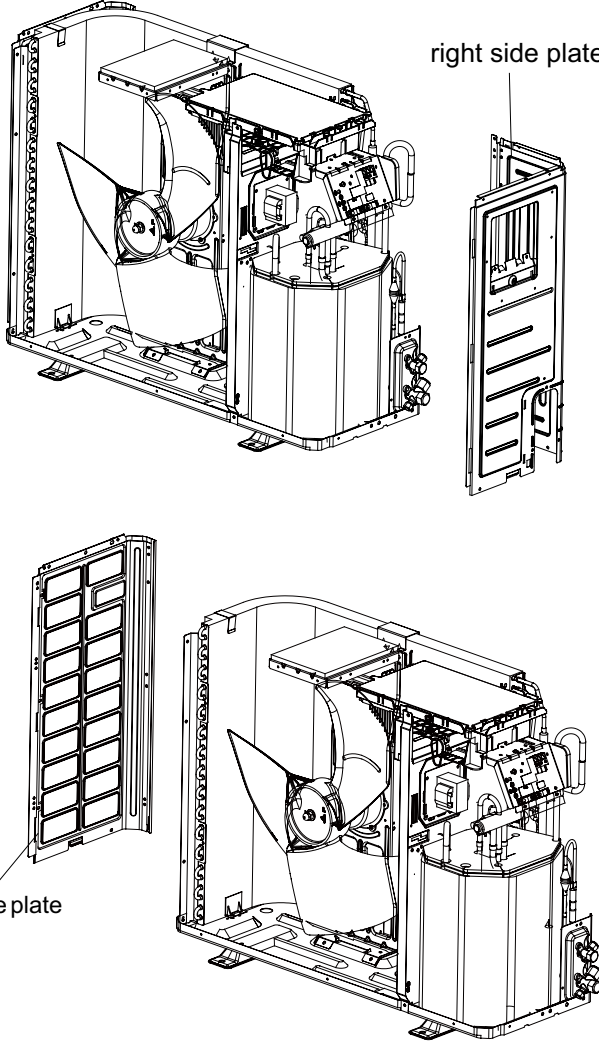
Steps	Procedure	
<p>2</p>	<p>Remove the 5 screws connecting the panel with the chassis and the motor support, and then remove the panel.</p> <p>Remove the 6 screws connecting the left side plate and right side plate and then remove rear grill</p>	
<p>3. Remove left side plate and right side plate</p>		
<p>1</p>	<p>Remove the screws connecting the right side plate with the chassis, the valve support and the electric box, and then remove the right side plate assy.</p>	
<p>2</p>	<p>Remove the screws connecting the left side plate and the chassis, and then remove the left side plate assy.</p>	

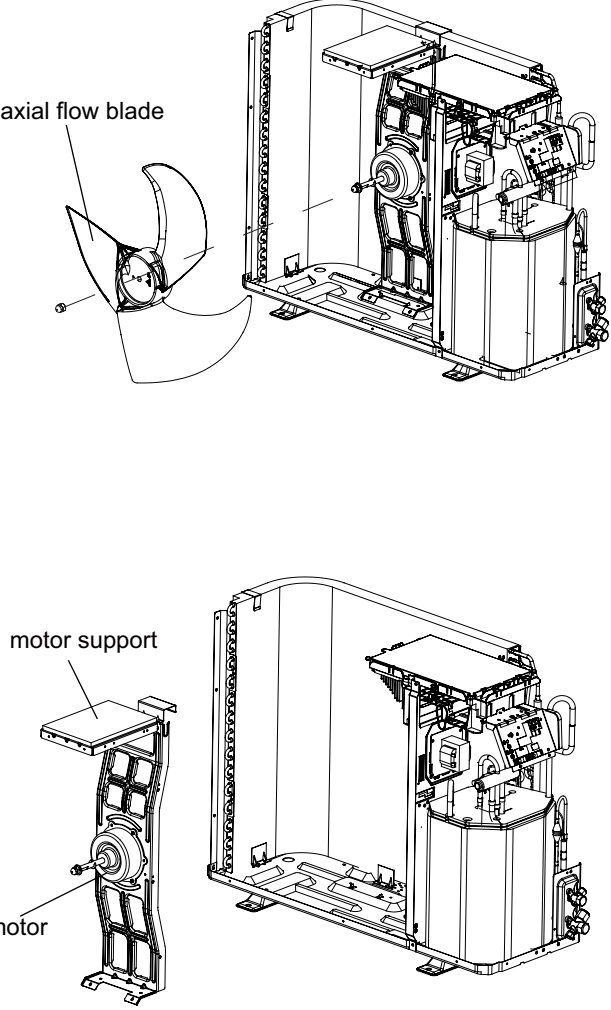
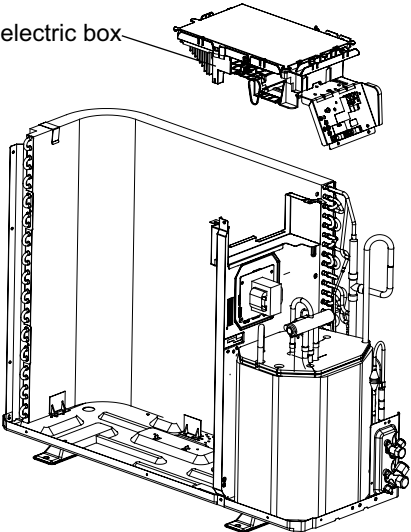
Steps	Procedure	Procedure
<p>4. Remove fan motor</p> <p>1</p>         <p>2</p>	<p>Remove the nuts fixing the blade and then remove the axial flow blade.</p>          <p>Remove the 4 tapping screws fixing the motor; disconnect the leading wire insert of the motor and then remove the motor. Remove the 2 tapping screws fixing the motor support and then pull the motor support upwards to remove it.</p>	 <p>axial flow blade</p> <p>motor support</p> <p>motor</p> <p>The diagram for step 4 shows two sub-figures. The upper sub-figure shows a perspective view of the fan motor assembly with a callout for an 'axial flow blade' pointing to a curved blade. The lower sub-figure shows the same assembly with a callout for 'motor support' pointing to a vertical metal frame and a callout for 'motor' pointing to the cylindrical motor unit.</p>
<p>5. Remove electric box</p>	<p>Remove the screws fixing the electric box sub-assy; loosen the wire bundle; pull out the wiring terminals and then pull the electric box upwards to remove it.</p>	 <p>electric box</p> <p>The diagram for step 5 shows a perspective view of the fan motor assembly with a callout for 'electric box' pointing to a rectangular metal box located above the motor.</p>

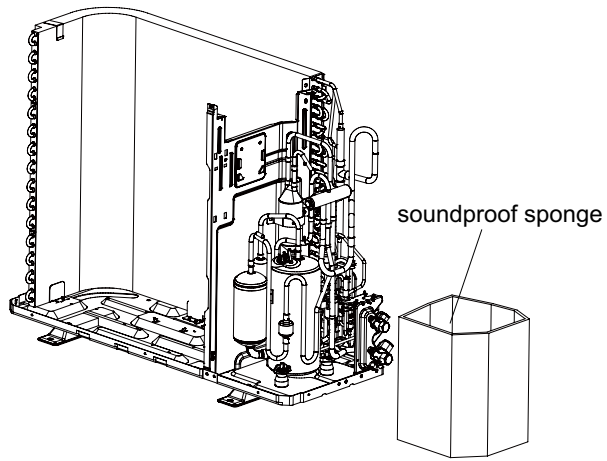
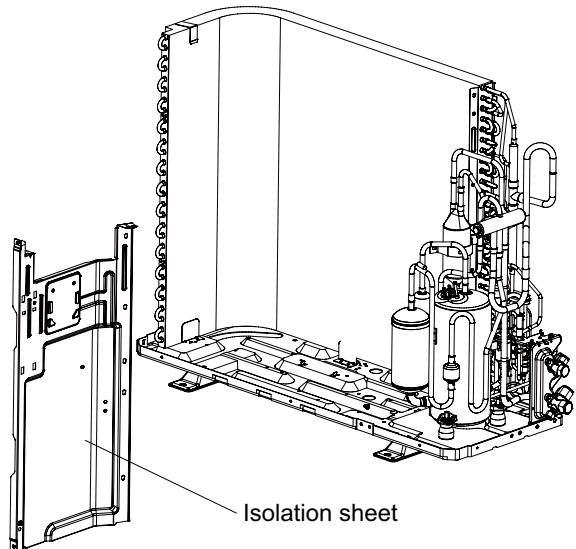
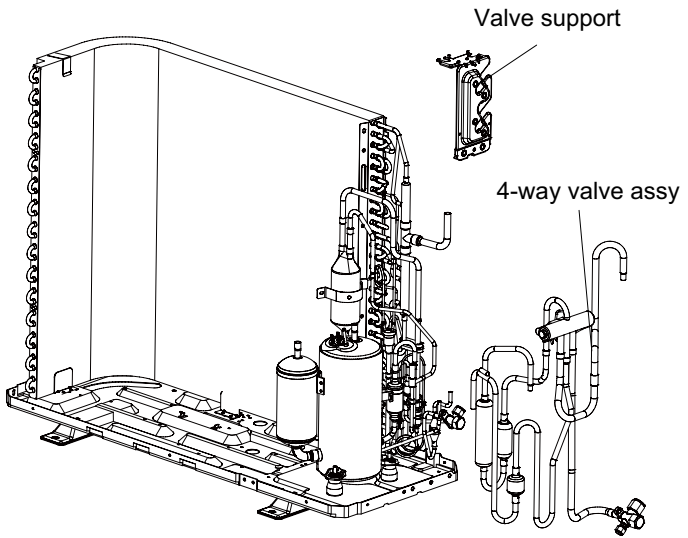
Steps	Procedure	Procedure
<p>6.Remove soundproof sponge</p>	<p>Since the piping ports on the soundproof sponge are torn easily, remove the soundproof sponge carefully</p>	
<p>7. Remove Isolation sheet</p>	<p>Remove the 3 screws fixing the isolation sheet and then remove the Isolation sheet.</p>	
<p>8. Remove valve support and 4-way valve assy</p>	<p>Remove the screws fixing valve support and then remove the valve support.</p> <p>Discharge the refrigerant completely;unsolder the pipelines connecting the compressor and the condenser assy,and then remove the 4-way valve assy.</p>	

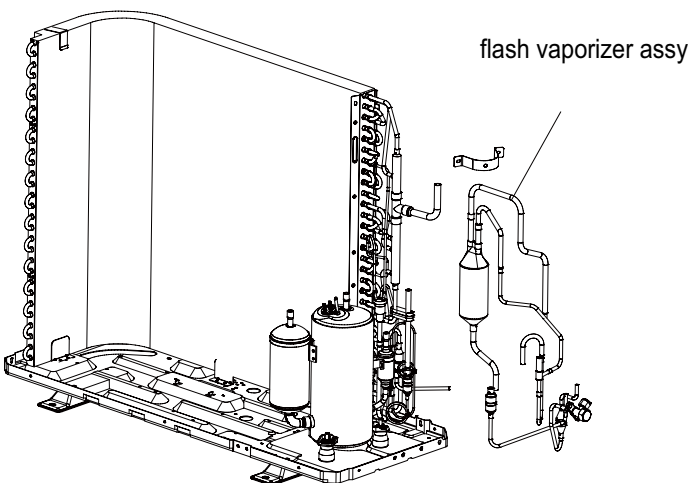
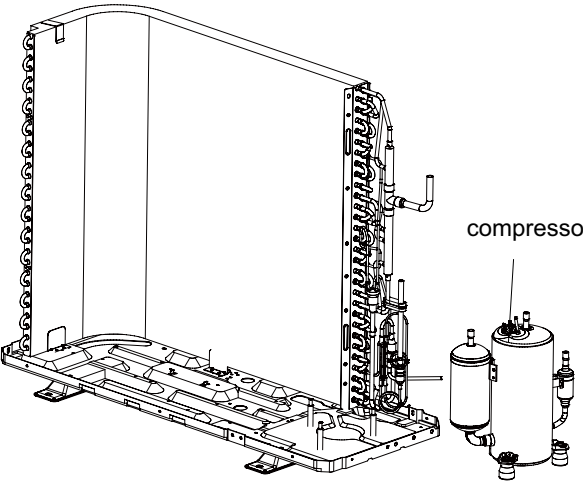
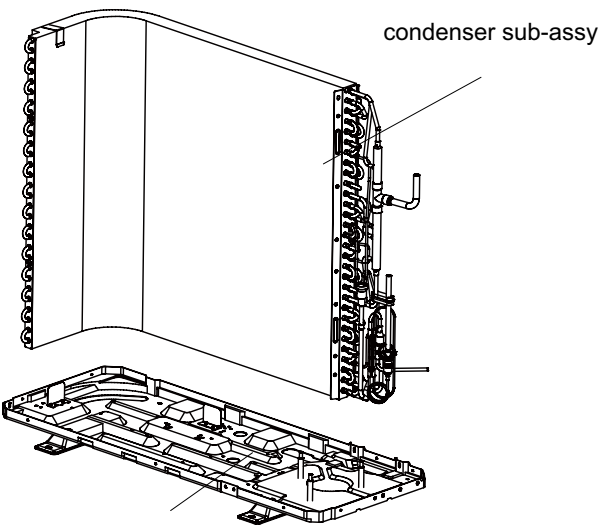
Steps	Procedure
<p>9. Remove flash vaporizer assy</p>	<p>Remove the screws connecting mid-isolation board, lift to remove the flash vaporizer assy</p> 
<p>10. Remove compressor</p>	<p>Remove the 3 foot nuts fixing the compressor and then remove the compressor.</p> 
<p>11. Remove condenser sub-assy</p>	<p>Remove the chassis sub-assy and condenser sub-assy.</p> 



## Appendix:

### Appendix 1: Reference Sheet of Celsius and Fahrenheit

Conversion formula for Fahrenheit degree and Celsius degree:  $T_f = T_c \times 1.8 + 32$

#### Set temperature

Fahrenheit display temperature (°F)	Fahrenheit (°F)	Celsius(°C)	Fahrenheit display temperature (°F)	Fahrenheit (°F)	Celsius(°C)	Fahrenheit display temperature (°F)	Fahrenheit (°F)	Celsius(°C)
61	60.8	16	69/70	69.8	21	78/79	78.8	26
62/63	62.6	17	71/72	71.6	22	80/81	80.6	27
64/65	64.4	18	73/74	73.4	23	82/83	82.4	28
66/67	66.2	19	75/76	75.2	24	84/85	84.2	29
68	68	20	77	77	25	86	86	30

#### Ambient temperature

Fahrenheit display temperature (°F)	Fahrenheit (°F)	Celsius(°C)	Fahrenheit display temperature (°F)	Fahrenheit (°F)	Celsius(°C)	Fahrenheit display temperature (°F)	Fahrenheit (°F)	Celsius(°C)
32/33	32	0	55/56	55.4	13	79/80	78.8	26
34/35	33.8	1	57/58	57.2	14	81	80.6	27
36	35.6	2	59/60	59	15	82/83	82.4	28
37/38	37.4	3	61/62	60.8	16	84/85	84.2	29
39/40	39.2	4	63	62.6	17	86/87	86	30
41/42	41	5	64/65	64.4	18	88/89	87.8	31
43/44	42.8	6	66/67	66.2	19	90	89.6	32
45	44.6	7	68/69	68	20	91/92	91.4	33
46/47	46.4	8	70/71	69.8	21	93/94	93.2	34
48/49	48.2	9	72	71.6	22	95/96	95	35
50/51	50	10	73/74	73.4	23	97/98	96.8	36
52/53	51.8	11	75/76	75.2	24	99	98.6	37
54	53.6	12	77/78	77	25			

### Appendix 2: Configuration of Connection Pipe

- Standard length of connection pipe (More details please refer to the specifications)
- Min length of connection pipe For the unit with standard connection pipe of 5m, there is no limitation for them in length of connection pipe. For the unit with standard connection pipe of 7.5m and 8m, the min length of connection pipe is 3m.
- Max length of connection pipe (More details please refer to the specifications)
- The additional refrigerant oil and refrigerant charging required after prolonging connection pipe
  - After the length of connection pipe is prolonged for 10m at the basis of standard length, you should add 5ml of refrigerant oil for each additional 5m of connection pipe.
  - The calculation method of additional refrigerant charging amount (on the basis of liquid pipe):
  - Basing on the length of standard pipe, add refrigerant according to the requirement as shown in the table. The additional refrigerant charging amount per meter is different according to the diameter of liquid pipe. See Sheet 2.
  - Additional refrigerant charging amount = prolonged length of liquid pipe X additional refrigerant charging amount per meter

Additional refrigerant charging amount for R32				
Diameter of connection pipe		Indoor unit throttl	Outdoor unit throttle	
Liquid pipe	Gas pipe	Cooling only, cooling and heating(g / m)	Cooling only(g / m)	Cooling and heating(g / m)
Φ6	Φ9.5 or Φ12	16	12	16
Φ6 or Φ9.5	Φ16 or Φ19	40	12	40
Φ12	Φ19 or Φ22.2	80	24	96
Φ16	Φ25.4 or Φ31.8	136	48	96
Φ19	/	200	200	200
Φ22.2	/	280	280	280

Note: The additional refrigerant charging amount in Sheet 2 is recommended value, not compulsory.

### Appendix 3: Pipe Expanding Method

**⚠ Note:**

Improper pipe expanding is the main cause of refrigerant leakage. Please expand the pipe according to the following steps:

A: Cut the pip

- Confirm the pipe length according to the distance of indoor unit and outdoor unit.
- Cut the required pipe with pipe cutter.

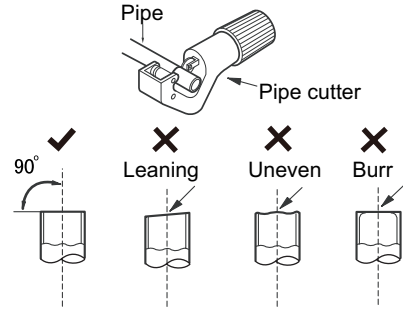

B: Remove the burrs

- Remove the burrs with shaper and prevent the burrs from getting into the pipe.

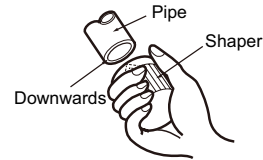

C: Put on suitable insulating pipe

D: Put on the union nut

- Remove the union nut on the indoor connection pipe and outdoor valve; install the union nut on the pipe.

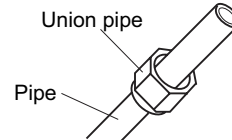

E: Expand the port

- Expand the port with expander.

**⚠ Note:**

- "A" is different according to the diameter, please refer to the sheet below:

Outer diameter(mm)	A(mm)	
	Max	Min
Φ6 - 6.35 (1/4")	1.3	0.7
Φ9.52 (3/8")	1.6	1.0
Φ12 - 12.70 (1/2")	1.8	1.0
Φ16 - 15.88 (5/8")	2.4	2.2

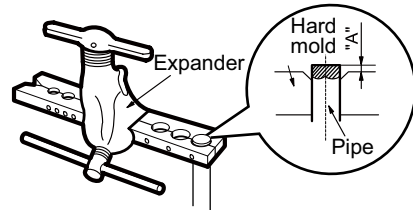

F: Inspection

- Check the quality of expanding port. If there is any blemish, expand the port again according to the steps above.

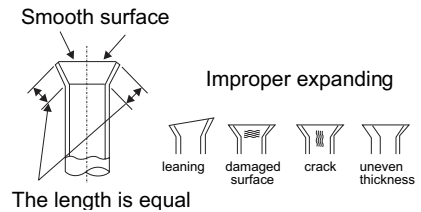

## Appendix 4: List of Resistance for Temperature Sensor

Resistance Table of Ambient Temperature Sensor for Indoor and Outdoor (15K)

Temp(°C)	Resistance(kΩ)	Temp(°C)	Resistance(kΩ)	Temp(°C)	Resistance(kΩ)	Temp(°C)	Resistance(kΩ)
-19	138.1	20	18.75	59	3.848	98	1.071
-18	128.6	21	17.93	60	3.711	99	1.039
-17	121.6	22	17.14	61	3.579	100	1.009
-16	115	23	16.39	62	3.454	101	0.98
-15	108.7	24	15.68	63	3.333	102	0.952
-14	102.9	25	15	64	3.217	103	0.925
-13	97.4	26	14.36	65	3.105	104	0.898
-12	92.22	27	13.74	66	2.998	105	0.873
-11	87.35	28	13.16	67	2.896	106	0.848
-10	82.75	29	12.6	68	2.797	107	0.825
-9	78.43	30	12.07	69	2.702	108	0.802
-8	74.35	31	11.57	70	2.611	109	0.779
-7	70.5	32	11.09	71	2.523	110	0.758
-6	66.88	33	10.63	72	2.439	111	0.737
-5	63.46	34	10.2	73	2.358	112	0.717
-4	60.23	35	9.779	74	2.28	113	0.697
-3	57.18	36	9.382	75	2.206	114	0.678
-2	54.31	37	9.003	76	2.133	115	0.66
-1	51.59	38	8.642	77	2.064	116	0.642
0	49.02	39	8.297	78	1.997	117	0.625
1	46.6	40	7.967	79	1.933	118	0.608
2	44.31	41	7.653	80	1.871	119	0.592
3	42.14	42	7.352	81	1.811	120	0.577
4	40.09	43	7.065	82	1.754	121	0.561
5	38.15	44	6.791	83	1.699	122	0.547
6	36.32	45	6.529	84	1.645	123	0.532
7	34.58	46	6.278	85	1.594	124	0.519
8	32.94	47	6.038	86	1.544	125	0.505
9	31.38	48	5.809	87	1.497	126	0.492
10	29.9	49	5.589	88	1.451	127	0.48
11	28.51	50	5.379	89	1.408	128	0.467
12	27.18	51	5.197	90	1.363	129	0.456
13	25.92	52	4.986	91	1.322	130	0.444
14	24.73	53	4.802	92	1.282	131	0.433
15	23.6	54	4.625	93	1.244	132	0.422
16	22.53	55	4.456	94	1.207	133	0.412
17	21.51	56	4.294	95	1.171	134	0.401
18	20.54	57	4.139	96	1.136	135	0.391
19	19.63	58	3.99	97	1.103	136	0.382

Resistance Table of Tube Temperature Sensors for Indoor and Outdoor (20K)

Temp(°C)	Resistance(kΩ)	Temp(°C)	Resistance(kΩ)	Temp(°C)	Resistance(kΩ)	Temp(°C)	Resistance(kΩ)
-19	181.4	20	25.01	59	5.13	98	1.427
-18	171.4	21	23.9	60	4.948	99	1.386
-17	162.1	22	22.85	61	4.773	100	1.346
-16	153.3	23	21.85	62	4.605	101	1.307
-15	145	24	20.9	63	4.443	102	1.269
-14	137.2	25	20	64	4.289	103	1.233
-13	129.9	26	19.14	65	4.14	104	1.198
-12	123	27	18.13	66	3.998	105	1.164
-11	116.5	28	17.55	67	3.861	106	1.131
-10	110.3	29	16.8	68	3.729	107	1.099
-9	104.6	30	16.1	69	3.603	108	1.069
-8	99.13	31	15.43	70	3.481	109	1.039
-7	94	32	14.79	71	3.364	110	1.01
-6	89.17	33	14.18	72	3.252	111	0.983
-5	84.61	34	13.59	73	3.144	112	0.956
-4	80.31	35	13.04	74	3.04	113	0.93
-3	76.24	36	12.51	75	2.94	114	0.904
-2	72.41	37	12	76	2.844	115	0.88
-1	68.79	38	11.52	77	2.752	116	0.856
0	65.37	39	11.06	78	2.663	117	0.833
1	62.13	40	10.62	79	2.577	118	0.811
2	59.08	41	10.2	80	2.495	119	0.77
3	56.19	42	9.803	81	2.415	120	0.769
4	53.46	43	9.42	82	2.339	121	0.746
5	50.87	44	9.054	83	2.265	122	0.729
6	48.42	45	8.705	84	2.194	123	0.71
7	46.11	46	8.37	85	2.125	124	0.692
8	43.92	47	8.051	86	2.059	125	0.674
9	41.84	48	7.745	87	1.996	126	0.658
10	39.87	49	7.453	88	1.934	127	0.64
11	38.01	50	7.173	89	1.875	128	0.623
12	36.24	51	6.905	90	1.818	129	0.607
13	34.57	52	6.648	91	1.736	130	0.592
14	32.98	53	6.403	92	1.71	131	0.577
15	31.47	54	6.167	93	1.658	132	0.563
16	30.04	55	5.942	94	1.609	133	0.549
17	28.68	56	5.726	95	1.561	134	0.535
18	27.39	57	5.519	96	1.515	135	0.521
19	26.17	58	5.32	97	1.47	136	0.509

Resistance Table of Discharge Temperature Sensor for Outdoor (50K)

Temp(°C)	Resistance(kΩ)	Temp(°C)	Resistance(kΩ)	Temp(°C)	Resistance(kΩ)	Temp(°C)	Resistance(kΩ)
-29	853.5	10	98	49	18.34	88	4.75
-28	799.8	11	93.42	50	17.65	89	4.61
-27	750	12	89.07	51	16.99	90	4.47
-26	703.8	13	84.95	52	16.36	91	4.33
-25	660.8	14	81.05	53	15.75	92	4.20
-24	620.8	15	77.35	54	15.17	93	4.08
-23	580.6	16	73.83	55	14.62	94	3.96
-22	548.9	17	70.5	56	14.09	95	3.84
-21	516.6	18	67.34	57	13.58	96	3.73
-20	486.5	19	64.33	58	13.09	97	3.62
-19	458.3	20	61.48	59	12.62	98	3.51
-18	432	21	58.77	60	12.17	99	3.41
-17	407.4	22	56.19	61	11.74	100	3.32
-16	384.5	23	53.74	62	11.32	101	3.22
-15	362.9	24	51.41	63	10.93	102	3.13
-14	342.8	25	49.19	64	10.54	103	3.04
-13	323.9	26	47.08	65	10.18	104	2.96
-12	306.2	27	45.07	66	9.83	105	2.87
-11	289.6	28	43.16	67	9.49	106	2.79
-10	274	29	41.34	68	9.17	107	2.72
-9	259.3	30	39.61	69	8.85	108	2.64
-8	245.6	31	37.96	70	8.56	109	2.57
-7	232.6	32	36.38	71	8.27	110	2.50
-6	220.5	33	34.88	72	7.99	111	2.43
-5	209	34	33.45	73	7.73	112	2.37
-4	198.3	35	32.09	74	7.47	113	2.30
-3	199.1	36	30.79	75	7.22	114	2.24
-2	178.5	37	29.54	76	7.00	115	2.18
-1	169.5	38	28.36	77	6.76	116	2.12
0	161	39	27.23	78	6.54	117	2.07
1	153	40	26.15	79	6.33	118	2.02
2	145.4	41	25.11	80	6.13	119	1.96
3	138.3	42	24.13	81	5.93	120	1.91
4	131.5	43	23.19	82	5.75	121	1.86
5	125.1	44	22.29	83	5.57	122	1.82
6	119.1	45	21.43	84	5.39	123	1.77
7	113.4	46	20.6	85	5.22	124	1.73
8	108	47	19.81	86	5.06	125	1.68
9	102.8	48	19.06	87	4.90	126	1.64



JF00304188



GREE ELECTRIC APPLIANCES, INC. OF ZHUHAI

Add: West Jinji Rd, Qianshan, Zhuhai, Guangdong, China, 519070

Tel: (+86-756) 8522219

Fax: (+86-756) 8669426

E-mail: [global@cn.gree.com](mailto:global@cn.gree.com) [www.gree.com](http://www.gree.com)

**For product improvement, specifications and appearance in this manual are subject to change without prior notice.**