



# Service Manual

**GREE ELECTRIC APPLIANCES, INC. OF ZHUHAI**



# Table of Contents

<b>Part I : Technical Information .....</b>	<b>1</b>
<b>1. Summary.....</b>	<b>1</b>
<b>2. Specifications.....</b>	<b>5</b>
2.1 Specification Sheet.....	5
2.2 Capacity Variation Ratio According to Temperature .....	33
2.3 Cooling and Heating Data Sheet in Rated Frequency.....	34
<b>3. Outline Dimension Diagram.....</b>	<b>35</b>
3.1 Indoor Unit.....	35
3.2 Outdoor Unit.....	36
<b>4. Refrigerant System Diagram .....</b>	<b>40</b>
<b>5. Electrical Part .....</b>	<b>41</b>
5.1 Wiring Diagram .....	41
5.2 PCB Printed Diagram.....	52
<b>6. Function and Control .....</b>	<b>61</b>
6.1 Remote Controller Introduction for YAP1F7(WiFi) .....	61
6.2 Remote Controller Introduction for YAC1FB9(WiFi) .....	66
6.3 Remote Controller Introduction for YAP1F2(WiFi) .....	72
6.4 Remote Controller Introduction for YAG1FB3(WiFi).....	77
6.5 GREE+ App Operation Manual .....	82
6.6 Ewpe Smart App Operation Manual.....	83
6.7 Brief Description of Models and Functions.....	84
<b>Part II : Installation and Maintenance .....</b>	<b>87</b>
<b>7. Notes for Installation and Maintenance.....</b>	<b>87</b>
<b>8. Installation .....</b>	<b>95</b>
8.1 Installation Dimension Diagram.....	95



8.2 Installation Parts-checking .....	97
8.3 Selection of Installation Location.....	97
8.4 Electric Connection Requirement .....	97
8.5 Installation of Indoor Unit.....	98
8.6 Installation of Outdoor unit.....	100
8.7 Vacuum Pumping and Leak Detection.....	101
8.8 Check after Installation and Test Operation .....	102
<b>9. Maintenance .....</b>	<b>103</b>
9.1 Error Code List.....	103
9.2 Procedure of Troubleshooting .....	109
9.3 Troubleshooting for Normal Malfunction .....	121
<b>10. Exploded View and Parts List.....</b>	<b>123</b>
10.1 Indoor Unit.....	123
10.2 Outdoor Unit .....	137
<b>11. Removal Procedure .....</b>	<b>151</b>
11.1 Removal Procedure of Indoor Unit .....	151
11.2 Removal Procedure of Outdoor Unit.....	156
<b>Appendix .....</b>	<b>185</b>
Appendix 1: Reference Sheet of Celsius and Fahrenheit.....	185
Appendix 2: Configuration of Connection Pipe .....	185
Appendix 3: Pipe Expanding Method.....	186
Appendix 4: List of Resistance for Temperature Sensor.....	187

# 1. Summary

## Indoor Unit:

A1 panel (White)



A1 panel (Sliver)



A1 panel (Black)



A1 panel (Champagne)



A1 panel (Red)



A2 panel



A3 panel



A4 panel



A5 panel

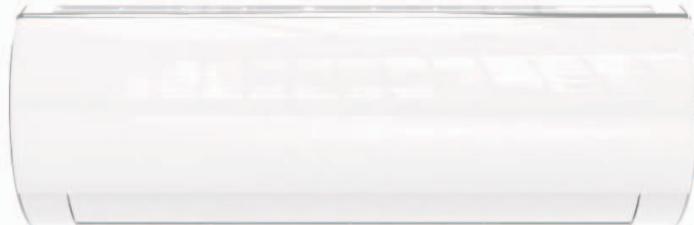

**Outdoor Unit:**

GWH07AGA-K6DNA1A/O

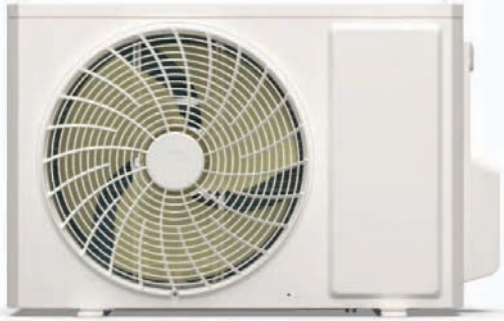

GWH09AGA-K6DNA1A/O GWH12AGB-K6DNA1A/O



GWH12AGBXB-K6DNA1A/O



GWH09YCXB-K6DNA1C/O GWH09AFC-K6DNA2F/O  
GWH09AGAXB-K6DNA1B/O GWH12AFC-K6DNA2F/O  
GWH18ALD-K6DNA1A/O



GWH12YCXD-K6DNA1B/O GWH18AFD-K6DNA2I/O

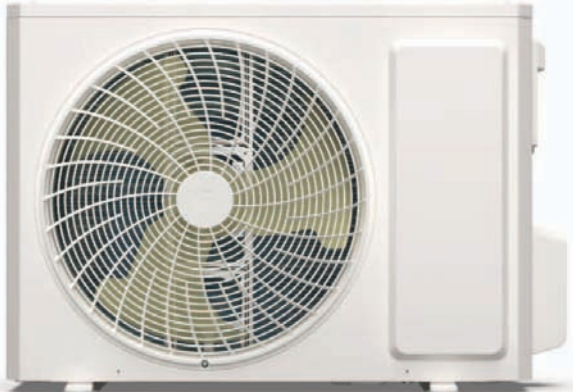

GWH24ALD-K6DNA1B/O

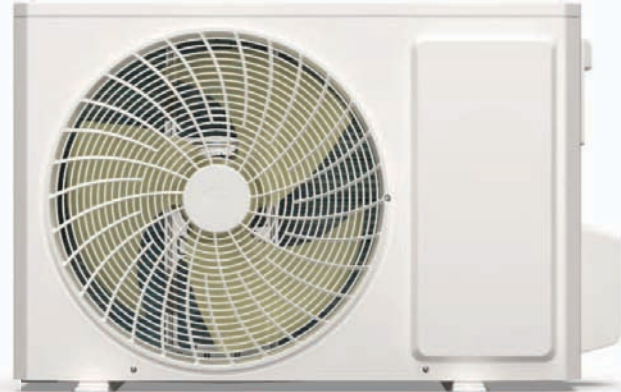

GWH18ACDXF-K6DNA1A/O GWH18YDXF-K6DNA1B/O  
GWH24AFE-K6DNA2I/O

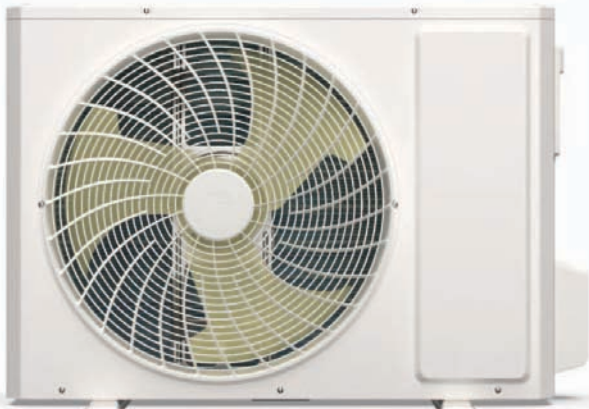

## Remote Controller:

YAP1F7(WiFi)



YAC1FB9(WiFi)



YAP1F2(WiFi)



YAG1FB3(WiFi)



## Model list:

No.	Model	Product code	Indoor model	Indoor product code	Outdoor model	Outdoor product code	Remote Controller	
1	GWH09ACAXB-K6DNA4B	CB344004800	GWH09ACAXB-K6DNA4B/I	CB344N04800	GWH09AGAXB-K6DNA1B/O	CB385W09900	YAP1F7 (WiFi)	
2	GWH12ACBXB-K6DNA4A	CB344004700	GWH12ACBXB-K6DNA4A/I	CB344N04700	GWH12AGBXB-K6DNA1A/O	CB385W17900		
3	GWH09ACC-K6DNA1F	CB497016000	GWH09ACC-K6DNA1F/I	CB497N16000	GWH09AFC-K6DNA2F/O	CB363W02900	YAC1FB9 (WiFi)	
4		CB497016001		CB497N16001				
5		CB497016002		CB497N16002				
6	GWH09ACC-K6DNA3F	CB343004700	GWH09ACC-K6DNA3F/I	CB343N04700				
7		CB343004701						
8	GWH09ACC-K6DNA1F	CB497016003	GWH09ACC-K6DNA1F/I	CB497N16000				
9		CB497016004		CB497N16002				
10		CB497016005		CB497N16005				
11		CB497016006		CB497N16006				
12		CB497016007		CB497N16007				
13		CB497016009		CB497N16009				
14		CB497016010		CB497N16010				
15	GWH09ACC-K6DNA2F	CB342002501	GWH09ACC-K6DNA2F/I	CB342N02500				
16	GWH09ACCXB-K6DNA4F	CB344003201	GWH09ACCXB-K6DNA4F/I	CB344N03200				
17	GWH09ACC-K6DNA5F	CB341004501	GWH09ACC-K6DNA5F/I	CB341N04500				
18	GWH12ACC-K6DNA1F	CB497015800	GWH12ACC-K6DNA1F/I	CB497N15800	GWH12AFC-K6DNA2F/O	CB363W03600	YAC1FB9 (WiFi)	
19		CB497015807		CB497N15802				
20		CB497015806		CB497N15803				
21		CB497015808		CB497N15808				
22		CB497015809		CB497N15809				
23		CB497015811		CB497N15811				
24		CB497015812		CB497N15812				
25	GWH12ACC-K6DNA2F	CB342002700	GWH12ACC-K6DNA2F/I	CB342N02700				
26	GWH12ACC-K6DNA3F	CB343004600	GWH12ACC-K6DNA3F/I	CB343N04600				
27	GWH12ACCXB-K6DNA4F	CB344003300	GWH12ACCXB-K6DNA4F/I	CB344N03300				
28		CB344003301		CB344N03301				
29	GWH12ACC-K6DNA5F	CB341002900	GWH12ACC-K6DNA5F/I	CB341N02900				
30		CB341002901		CB341N02901				
31	GWH12ACC-K6DNA1F	CB497015801	GWH12ACC-K6DNA1F/I	CB497N15800				CB363W03601
32		CB497015802		CB497N15802				
33		CB497015803		CB497N15803				
34	GWH12ACC-K6DNA3F	CB343004601	GWH12ACC-K6DNA3F/I	CB343N04600				

No.	Model	Product code	Indoor model	Indoor product code	Outdoor model	Outdoor product code	Remote Controller
35	GWH18ACD-K6DNA1I	CB497016200	GWH18ACD-K6DNA1I/I	CB497N16200	GWH18AFD-K6DNA2I/O	CB363W04200	
36		CB497016205		CB497N16204			
37		CB497016206		CB497N16202			
38		CB497016201		CB497N16200			
39		CB497016202		CB497N16202			
40		CB497016203		CB497N16203			
41		CB497016204		CB497N16204			
42		CB497016207		CB497N16207			
43		CB497016208		CB497N16208			
44		CB497016209		CB497N16209		CB363W04201	
45	GWH18ACD-K6DNA2I	CB342002801	GWH18ACD-K6DNA2I/I	CB342N02800			
46	GWH18ACDXD-K6DNA3I	CB343006001	GWH18ACDXD-K6DNA3I/I	CB343N06000			
47	GWH18ACDXD-K6DNA4I	CB344002901	GWH18ACDXD-K6DNA4I/I	CB344N02900			
48		CB344002902		CB344N02902			
49	GWH18ACD-K6DNA5I	CB341003301	GWH18ACD-K6DNA5I/I	CB341N03300			
50		CB341003302		CB341N03302			
51	GWH18ACDXF-K6DNA1A	CB497016900	GWH18ACDXF-K6DNA1A/I	CB497N16900	GWH18ACDXF-K6DNA1A/O	CB497W16900	YAC1FB9 (WiFi)
52	GWH18ACDXF-K6DNA3A	CB343004500	GWH18ACDXF-K6DNA3A/I	CB343N04500			
53	GWH18ACDXF-K6DNA1A	CB497016901	GWH18ACDXF-K6DNA1A/I	CB497N16900			
54		CB497016902		CB497N16902			
55		CB497016903		CB497N16903			
56		CB497016904		CB497N16904			
57	CB497016905	CB497N16905					
58	GWH24ACE-K6DNA1I	CB497016100	GWH24ACE-K6DNA1I/I	CB497N16100		CB363W04100	
59		CB497016105		CB497N16104			
60		CB497016106		CB497N16102			
61	GWH24ACE-K6DNA3J	CB343004400	GWH24ACE-K6DNA3J/I	CB343N04400			
62		CB343004401					
63	GWH24ACE-K6DNA1I	CB497016101	GWH24ACE-K6DNA1I/I	CB497N16100	GWH24AFE-K6DNA2I/O	CB363W04101	
64		CB497016102		CB497N16102			
65		CB497016103		CB497N16103			
66		CB497016104		CB497N16104			
67		CB497016107		CB497N16107			
68		CB497016108		CB497N16108			
69		CB497016109		CB497N16109			
70	GWH24ACE-K6DNA2I	CB342002601	GWH24ACE-K6DNA2I/I	CB342N02600			
71	GWH24ACEXF-K6DNA4I	CB344003001	GWH24ACEXF-K6DNA4I/I	CB344N03000			
72		CB344003002		CB344N03002			
73	GWH24ACE-K6DNA5I	CB341004601	GWH24ACE-K6DNA5I/I	CB341N04600			
74	GWH07ACAXA-K6DNA4A	CB344004900	GWH07ACAXA-K6DNA4A/I	CB344N04900	GWH07AGA-K6DNA1A/O	CB385W01100	
75	GWH09ACA-K6DNA3A	CB343005000	GWH09ACA-K6DNA3A/I	CB343N05000	GWH09AGA-K6DNA1A/O	CB385W01000	
76	GWH12ACB-K6DNA3D	CB343005100	GWH12ACB-K6DNA3D/I	CB343N05100	GWH12AGB-K6DNA1A/O	CB385W01700	
77	GWH18ACDXB-K6DNA1E	CB497020900	GWH18ACDXB-K6DNA1E/I	CB497N20900	GWH18ALD-K6DNA1A/O	CB513W01600	YAP1F2 (WiFi)
78		CB497020901		CB497N20901			
79		CB497020902		CB497N20902			
80	GWH18ACDXB-K6DNA2E	CB342003600	GWH18ACDXB-K6DNA2E/I	CB342N03600			
81	GWH18ACDXB-K6DNA3A	CB343005200	GWH18ACDXB-K6DNA3A/I	CB343N05200			
82	GWH18ACDXB-K6DNA4A	CB344003100	GWH18ACDXB-K6DNA4A/I	CB344N03100			
83	GWH24ACD-K6DNA1B	CB497020400	GWH24ACD-K6DNA1B/I	CB497N20400	GWH24ALD-K6DNA1B/O	CB513W02200	
84	GWH24ACDXE-K6DNA3B	CB343004900	GWH24ACDXE-K6DNA3B/I	CB343N04900			
85	GWH24ACDXE-K6DNA4B	CB344003400	GWH24ACDXE-K6DNA4B/I	CB344N03400			
86	GWH09ACCXB-K6DNA3C	CB343005301	GWH09ACCXB-K6DNA3C/I	CB343N05300	GWH09YCXB-K6DNA1C/O	CB437W04901	YAG1FB3 (WiFi)
87	GWH12ACXD-K6DNA3B	CB343005401	GWH12ACXD-K6DNA3B/I	CB343N05400	GWH12YCXD-K6DNA1B/O	CB437W04501	
88	GWH18ACDXF-K6DNA3B	CB343005501	GWH18ACDXF-K6DNA3B/I	CB343N05500	GWH18YDXF-K6DNA1B/O	CB437W04801	



# 2. Specifications

## 2.1 Specification Sheet

Model			GWH07ACAXA-K6DNA4A	
Product Code			CB344004900	
Power Supply	Rated Voltage	V~	220-240	
	Rated Frequency	Hz	50	
	Phases		1	
Power Supply Mode			Outdoor	
Cooling Capacity		W	2200	
Heating Capacity		W	2400	
Cooling Power Input		W	590	
Heating Power Input		W	590	
Cooling Current Input		A	2.9	
Heating Current Input		A	2.9	
Rated Input		W	1300	
Rated Cooling Current		A	5	
Rated Heating Current		A	6	
Air Flow Volume		m <sup>3</sup> /h	500/470/420/250	
Dehumidifying Volume		L/h	0.6	
EER		W/W	3.73	
COP		W/W	4.07	
SEER			6.6	
SCOP(Average/WarmerColder)			/	
Application Area		m <sup>2</sup>	10-16	
Indoor Unit	Model		GWH07ACAXA-K6DNA4A/I	
	Product Code		CB344N04900	
	Fan Type		Cross-flow	
	Fan Diameter Length(DXL)		mm	Φ98×507
	Cooling Speed		r/min	1300/1200/1050/750
	Heating Speed		r/min	1300/1200/1050/800
	Fan Motor Power Output		W	10
	Fan Motor RLA		A	0.15
	Fan Motor Capacitor		μF	1
	Evaporator Form			Aluminum Fin-copper Tube
	Evaporator Pipe Diameter		mm	Φ5
	Evaporator Row-fin Gap		mm	2-1.5
	Evaporator Coil Length (LXDXW)		mm	510×22.8×266.7
	Swing Motor Model			MP24AN
	Swing Motor Power Output		W	1.5
	Fuse Current		A	3.15
	Sound Pressure Level		dB (A)	Cooling:39/36/33/22 Heating:38/36/32/25
	Sound Power Level		dB (A)	Cooling:55/48/45/37 Heating:55/49/45/38
	Dimension (WXHXD)		mm	744X256X185
	Dimension of Carton Box (LXWXH)		mm	788X314X249
	Dimension of Package (LXWXH)		mm	793X330X260
Net Weight		kg	8	
Gross Weight		kg	9.5	

Outdoor Unit	Outdoor Unit Model		GWH07AGA-K6DNA1A/O
	Outdoor Unit Product Code		CB385W01100
	Compressor Manufacturer		ZHUHAI LANDA COMPRESSOR CO., LTD.
	Compressor Model		QXF-N075zC170
	Compressor Oil		FW68DA
	Compressor Type		Rotary
	Compressor LRA.	A	/
	Compressor RLA	A	3
	Compressor Power Input	W	633
	Compressor Overload Protector		/
	Throttling Method		Capillary
	Set Temperature Range	°C	16~30
	Cooling Operation Ambient Temperature Range	°C	-15~43
	Heating Operation Ambient Temperature Range	°C	-15~24
	Condenser Form		Aluminum Fin-copper Tube
	Condenser Pipe Diameter	mm	Φ7.94
	Condenser Rows-fin Gap	mm	1-1.2
	Condenser Coil Length (LXD <sub>XW</sub> )	mm	637×12.7×419
	Fan Motor Speed	rpm	950
	Fan Motor Power Output	W	30
	Fan Motor RLA	A	0.4
	Fan Motor Capacitor	μF	/
	Outdoor Unit Air Flow Volume	m <sup>3</sup> /h	1400
	Fan Type		Axial-flow
	Fan Diameter	mm	Φ350
	Defrosting Method		/
	Climate Type		T1
	Isolation		I
	Moisture Protection		IPX4
	Permissible Excessive Operating Pressure for the Discharge Side	MPa	4.3
	Permissible Excessive Operating Pressure for the Suction Side	MPa	2.5
	Sound Pressure Level	dB (A)	50
	Sound Power Level	dB (A)	60
Dimension(WXH <sub>XD</sub> )	mm	710X450X293	
Dimension of Carton Box (LXWXH)	mm	761X327X500	
Dimension of Package(LXWXH)	mm	764X330X525	
Net Weight	kg	21	
Gross Weight	kg	23	
Refrigerant		R32	
Refrigerant Charge	kg	0.45	
Connection Pipe	Connection Pipe Length	m	5
	Connection Pipe Gas Additional Charge	g/m	16
	Outer Diameter Liquid Pipe	inch	1/4
	Outer Diameter Gas Pipe	inch	3/8
	Max Distance Height	m	10
	Max Distance Length	m	15
	Note: The connection pipe applies metric diameter.		

The above data is subject to change without notice. Please refer to the nameplate of the unit.

Model			GWH09ACAXB-K6DNA4B	GWH12ACBXB-K6DNA4A
Product Code			CB344004800	CB344004700
Power Supply	Rated Voltage	V~	220-240	220-240
	Rated Frequency	Hz	50	50
	Phases		1	1
Power Supply Mode			Outdoor	Outdoor
Cooling Capacity		W	2500	3200
Heating Capacity		W	2800	3400
Cooling Power Input		W	680	991
Heating Power Input		W	730	916
Cooling Current Input		A	3.1	4.4
Heating Current Input		A	3.2	4
Rated Input		W	1500	1500
Rated Cooling Current		A	6	6
Rated Heating Current		A	7.5	7.5
Air Flow Volume		m <sup>3</sup> /h	500/470/430/390/320/270/250	590/520/480/400/350/320/280
Dehumidifying Volume		L/h	0.8	1.4
EER		W/W	3.68	3.23
COP		W/W	3.84	3.71
SEER			6.6	6.1
SCOP(Average/WarmerColder)			/	/
Application Area		m <sup>2</sup>	12-18	15-22
Indoor Unit	Model		GWH09ACAXB-K6DNA4B/I	GWH12ACBXB-K6DNA4A/I
	Product Code		CB344N04800	CB344N04700
	Fan Type		Cross-flow	Cross-flow
	Fan Diameter Length(DXL)	mm	Φ98×507	Φ93×580
	Cooling Speed	r/min	1300/1200/1120/1050/920/800/750	1350/1200/1150/1100/1000/900/850
	Heating Speed	r/min	1300/1200/1120/1050/950/850/800	1350/1200/1150/1100/1020/950/900
	Fan Motor Power Output	W	10	20
	Fan Motor RLA	A	0.2	0.22
	Fan Motor Capacitor	μF	1	1
	Evaporator Form		Aluminum Fin-copper Tube	Aluminum Fin-copper Tube
	Evaporator Pipe Diameter	mm	Φ5	Φ5
	Evaporator Row-fin Gap	mm	2-1.5	2-1.4
	Evaporator Coil Length (LXDXW)	mm	510×22.8×266.7	584×22.8×266.7
	Swing Motor Model		MP24AN	MP24AN
	Swing Motor Power Output	W	1.5	1.5
	Fuse Current	A	3.15	3.15
	Sound Pressure Level	dB (A)	Cooling:38/36/34/32/28/25/22 Heating:38/36/34/32/29/25/23	Cooling:41/37/35/33/30/26/24 Heating:41/37/35/33/31/28/25
	Sound Power Level	dB (A)	Cooling:55/48/46/44/40/37/34 Heating:55/48/46/44/41/37/35	Cooling:56/49/47/45/42/38/36 Heating:53/49/47/45/43/40/37
	Dimension (WXHXD)	mm	744X256X185	819X256X185
	Dimension of Carton Box (LXWXH)	mm	788X314X249	863X314X249
Dimension of Package (LXWXH)	mm	793X330X260	868X330X260	
Net Weight	kg	8	8.5	
Gross Weight	kg	9.5	10	



Outdoor Unit	Outdoor Unit Model		GWH09AGAXB-K6DNA1B/O	GWH12AGBXB-K6DNA1A/O
	Outdoor Unit Product Code		CB385W09900	CB385W17900
	Compressor Manufacturer		ZHUHAI LANDA COMPRESSOR CO., LTD.	ZHUHAI LANDA COMPRESSOR CO., LTD.
	Compressor Model		QXF-A082zC170	QXF-N088zC170
	Compressor Oil		ZE-G;ES RB68GX or equivalent	FW68DA or equivalent
	Compressor Type		Rotary	Rotary
	Compressor LRA.	A	15	/
	Compressor RLA	A	2.56	3.6
	Compressor Power Input	W	756.6	758
	Compressor Overload Protector		/	/
	Throttling Method		Capillary	Capillary
	Set Temperature Range	°C	16~30	16~30
	Cooling Operation Ambient Temperature Range	°C	-15~43	-15~43
	Heating Operation Ambient Temperature Range	°C	-15~24	-15~24
	Condenser Form		Aluminum Fin-copper Tube	Aluminum Fin-copper Tube
	Condenser Pipe Diameter	mm	Φ7	Φ7
	Condenser Rows-fin Gap	mm	1-1.2	1-1.2
	Condenser Coil Length (LXD <sub>X</sub> W)	mm	666×19.05×527	700×19.05×528
	Fan Motor Speed	rpm	850	900
	Fan Motor Power Output	W	30	30
	Fan Motor RLA	A	0.4	0.4
	Fan Motor Capacitor	μF	/	/
	Outdoor Unit Air Flow Volume	m <sup>3</sup> /h	1950	1950
	Fan Type		Axial-flow	Axial-flow
	Fan Diameter	mm	Φ400	Φ400
	Defrosting Method		Automatic Defrosting	Automatic Defrosting
	Climate Type		T1	T1
	Isolation		I	I
	Moisture Protection		IPX4	IPX4
	Permissible Excessive Operating Pressure for the Discharge Side	MPa	4.3	4.3
	Permissible Excessive Operating Pressure for the Suction Side	MPa	2.5	2.5
	Sound Pressure Level	dB (A)	50	52
Sound Power Level	dB (A)	60	63	
Dimension(WXHXD)	mm	732X555X330	732X555X330	
Dimension of Carton Box (LXWXH)	mm	791X373X590	791X373X590	
Dimension of Package(LXWXH)	mm	794X376X615	794X376X615	
Net Weight	kg	24.5	25	
Gross Weight	kg	27	27.5	
Refrigerant		R32	R32	
Refrigerant Charge	kg	0.48	0.55	
Connection Pipe	Connection Pipe Length	m	5	5
	Connection Pipe Gas Additional Charge	g/m	16	16
	Outer Diameter Liquid Pipe	inch	1/4	1/4
	Outer Diameter Gas Pipe	inch	3/8	3/8
	Max Distance Height	m	10	10
	Max Distance Length	m	15	20
Note: The connection pipe applies metric diameter.				

The above data is subject to change without notice. Please refer to the nameplate of the unit.

Model			GWH09ACC-K6DNA1F GWH09ACCXB-K6DNA4F	GWH12ACC-K6DNA1F GWH12ACC-K6DNA5F GWH12ACCXB-K6DNA4F
Product Code			CB497016005/CB497016010 CB344003201	CB497015808/CB497015812 CB341002900 CB344003300
Power Supply	Rated Voltage	V~	220-240	220-240
	Rated Frequency	Hz	50	50
	Phases		1	1
Power Supply Mode			Outdoor	Outdoor
Cooling Capacity		W	2700	3510
Heating Capacity		W	3000	3810
Cooling Power Input		W	695	962
Heating Power Input		W	700	953
Cooling Current Input		A	3.1	4.3
Heating Current Input		A	3.2	4.6
Rated Input		W	1400	1550
Rated Cooling Current		A	6	6.2
Rated Heating Current		A	6.2	6.9
Air Flow Volume		m <sup>3</sup> /h	610/570/540/470/440/420/390	700/650/600/540/480/420/360/300
Dehumidifying Volume		L/h	1.69	1.4
EER		W/W	3.885	3.65
COP		W/W	4.286	4
SEER			7.5	7.1
SCOP(Average/WarmerColder)			4.2/5.3/3.4	4.1/5.2/3.1
Application Area		m <sup>2</sup>	12-18	16-24
Indoor Unit	Model		GWH09ACC-K6DNA1F/I GWH09ACCXB-K6DNA4F/I	GWH12ACC-K6DNA1F/I GWH12ACC-K6DNA5F/I GWH12ACCXB-K6DNA4F/I
	Product Code		CB497N16005/CB497N16010 CB344N03200	CB497N15808/CB497N15812 CB341N02900 CB344N03300
	Fan Type		Cross-flow	Cross-flow
	Fan Diameter Length(DXL)	mm	Φ98×633.5	Φ98×633.5
	Cooling Speed	r/min	1200/1100/1050/950/900/850/800	1350/1200/1100/1000/920/850/800
	Heating Speed	r/min	1150/1100/1050/1000/950/900/850	1300/1200/1120/1050/980/900/850
	Fan Motor Power Output	W	20	20
	Fan Motor RLA	A	0.31	0.31
	Fan Motor Capacitor	μF	1.5	1.5
	Evaporator Form		Aluminum Fin-copper Tube	Aluminum Fin-copper Tube
	Evaporator Pipe Diameter	mm	Φ5	Φ5
	Evaporator Row-fin Gap	mm	2-1.4	2-1.4
	Evaporator Coil Length (LXDXW)	mm	635×22.8×306.3	635×22.8×306.3
	Swing Motor Model		MP24HF	MP24HF
	Swing Motor Power Output	W	1.5	1.5
	Fuse Current	A	3.15	3.15
	Sound Pressure Level	dB (A)	Cooling:38/36/34/31/29/27/25 Heating:38/37/35/34/32/29/28	Cooling:42/38/35/32/29/26/25 Heating:42/38/36/34/32/30/28
	Sound Power Level	dB (A)	Cooling:54/48/46/43/41/39/37 Heating:56/49/47/46/44/41/40	Cooling:57/50/47/44/41/38/37 Heating:52/48/46/44/42/40/38
	Dimension (WXHXD)	mm	889X294X212	889X294X212
	Dimension of Carton Box (LXWXH)	mm	935X349X273	935X349X273
Dimension of Package (LXWXH)	mm	940X365X284	940X365X284	
Net Weight	kg	11	11	
Gross Weight	kg	13	13	

Outdoor Unit	Outdoor Unit Model		GWH09AFC-K6DNA2F/O	GWH12AFC-K6DNA2F/O
	Outdoor Unit Product Code		CB363W02901	CB363W03600
	Compressor Manufacturer		ZHUHAI LANDA COMPRESSOR CO., LTD.	ZHUHAI LANDA COMPRESSOR CO., LTD.
	Compressor Model		QXF-A082zC170	FTz-AN108ACBD
	Compressor Oil		ZE-G;ES RB68GX or equivalent	FW68DA or equivalent
	Compressor Type		Rotary	Rotary
	Compressor LRA.	A	15	/
	Compressor RLA	A	2.56	4.4
	Compressor Power Input	W	756.6	/
	Compressor Overload Protector		/	/
	Throttling Method		Capillary	Electron expansion valve
	Set Temperature Range	°C	16~30	16~30
	Cooling Operation Ambient Temperature Range	°C	-15~50	-15~50
	Heating Operation Ambient Temperature Range	°C	-25~30	-25~30
	Condenser Form		Aluminum Fin-copper Tube	Aluminum Fin-copper Tube
	Condenser Pipe Diameter	mm	Φ7	Φ7.94
	Condenser Rows-fin Gap	mm	1-1.2	1-1.2
	Condenser Coil Length (LXD <sub>X</sub> W)	mm	666×19.05×527	666×19.05×527
	Fan Motor Speed	rpm	900	900
	Fan Motor Power Output	W	30	30
	Fan Motor RLA	A	0.4	0.4
	Fan Motor Capacitor	μF	/	/
	Outdoor Unit Air Flow Volume	m <sup>3</sup> /h	1950	1950
	Fan Type		Axial-flow	Axial-flow
	Fan Diameter	mm	Φ400	Φ400
	Defrosting Method		Automatic Defrosting	Automatic Defrosting
	Climate Type		T1	T1
	Isolation		I	I
	Moisture Protection		IPX4	IPX4
	Permissible Excessive Operating Pressure for the Discharge Side	MPa	4.3	4.3
	Permissible Excessive Operating Pressure for the Suction Side	MPa	2.5	2.5
	Sound Pressure Level	dB (A)	50	52
	Sound Power Level	dB (A)	61	63
Dimension(WXHXD)	mm	732X555X330	732X555X330	
Dimension of Carton Box (LXWXH)	mm	791X373X590	791X373X590	
Dimension of Package(LXWXH)	mm	794X376X615	794X376X605	
Net Weight	kg	24.5	24.5	
Gross Weight	kg	27	27	
Refrigerant		R32	R32	
Refrigerant Charge	kg	0.53	0.57	
Connection Pipe	Connection Pipe Length	m	5	5
	Connection Pipe Gas Additional Charge	g/m	16	16
	Outer Diameter Liquid Pipe	inch	1/4	1/4
	Outer Diameter Gas Pipe	inch	3/8	3/8
	Max Distance Height	m	10	10
	Max Distance Length	m	15	15
Note: The connection pipe applies metric diameter.				

The above data is subject to change without notice. Please refer to the nameplate of the unit.

Model			GWH09ACA-K6DNA3A	GWH12ACB-K6DNA3D
Product Code			CB343005000	CB343005100
Power Supply	Rated Voltage	V~	220-240	220-240
	Rated Frequency	Hz	50	50
	Phases		1	1
Power Supply Mode			Outdoor	Outdoor
Cooling Capacity		W	2500	3200
Heating Capacity		W	2800	3400
Cooling Power Input		W	720	991
Heating Power Input		W	750	916
Cooling Current Input		A	3.2	4.4
Heating Current Input		A	3.2	4
Rated Input		W	1500	1500
Rated Cooling Current		A	6	6
Rated Heating Current		A	7.5	7.5
Air Flow Volume		m <sup>3</sup> /h	500/470/390/250	590/520/400/280
Dehumidifying Volume		L/h	0.6	1.4
EER		W/W	3.47	3.23
COP		W/W	3.73	3.71
SEER			6.5	6.1
SCOP(Average/WarmerColder)			4.0/5.1/-	4.0/5.1/-
Application Area		m <sup>2</sup>	10-16	15-22
Indoor Unit	Model		GWH09ACA-K6DNA3A/I	GWH12ACB-K6DNA3D/I
	Product Code		CB343N05000	CB343N05100
	Fan Type		Cross-flow	Cross-flow
	Fan Diameter Length(DXL)	mm	Φ93×505	Φ93×580
	Cooling Speed	r/min	1300/1200/1050/750	1350/1200/1100/850
	Heating Speed	r/min	1300/1200/1050/800	1350/1200/1100/900
	Fan Motor Power Output	W	20	20
	Fan Motor RLA	A	0.22	0.22
	Fan Motor Capacitor	μF	1	1
	Evaporator Form		Aluminum Fin-copper Tube	Aluminum Fin-copper Tube
	Evaporator Pipe Diameter	mm	Φ5	Φ5
	Evaporator Row-fin Gap	mm	2-1.4	2-1.4
	Evaporator Coil Length (LXDXW)	mm	509X22.8X266.7	584X22.8X266.7
	Swing Motor Model		MP24AN	MP24AN
	Swing Motor Power Output	W	1.5	1.5
	Fuse Current	A	3.15	3.15
	Sound Pressure Level	dB (A)	Cooling:38/36/32/21 Heating:37/36/33/25	Cooling:41/37/33/24 Heating:41/37/33/25
	Sound Power Level	dB (A)	Cooling:55/48/44/33 Heating:49/48/45/37	Cooling:56/49/45/36 Heating:53/49/45/37
	Dimension (WXHXD)	mm	744X256X185	819X256X185
	Dimension of Carton Box (LXWXH)	mm	788X314X249	863X314X249
Dimension of Package (LXWXH)	mm	793X330X260	868X330X260	
Net Weight	kg	7.5	8.5	
Gross Weight	kg	9	10	

Outdoor Unit	Outdoor Unit Model		GWH09AGA-K6DNA1A/O	GWH12AGB-K6DNA1A/O
	Outdoor Unit Product Code		CB385W01000	CB385W01700
	Compressor Manufacturer		ZHUHAI LANDA COMPRESSOR CO., LTD.	ZHUHAI LANDA COMPRESSOR CO., LTD.
	Compressor Model		FTz-AN075ACBF-A	FTz-AN088ACBF-A
	Compressor Oil		FW68DA	FW68DA
	Compressor Type		Rotary	Rotary
	Compressor LRA.	A	/	/
	Compressor RLA	A	3	3.6
	Compressor Power Input	W	633	758
	Compressor Overload Protector		/	/
	Throttling Method		Capillary	Capillary
	Set Temperature Range	°C	16~30	16~30
	Cooling Operation Ambient Temperature Range	°C	-15~43	-15~43
	Heating Operation Ambient Temperature Range	°C	-15~24	-15~24
	Condenser Form		Aluminum Fin-copper Tube	Aluminum Fin-copper Tube
	Condenser Pipe Diameter	mm	Φ7	Φ7
	Condenser Rows-fin Gap	mm	1-1.4	1-1.4
	Condenser Coil Length (LXDXW)	mm	700×19.05×528	700×19.05×528
	Fan Motor Speed	rpm	900	900
	Fan Motor Power Output	W	30	30
	Fan Motor RLA	A	0.4	0.4
	Fan Motor Capacitor	μF	/	/
	Outdoor Unit Air Flow Volume	m <sup>3</sup> /h	2200	2200
	Fan Type		Axial-flow	Axial-flow
	Fan Diameter	mm	Φ400	Φ400
	Defrosting Method		Automatic Defrosting	Automatic Defrosting
	Climate Type		T1	T1
	Isolation		I	I
	Moisture Protection		IPX4	IPX4
	Permissible Excessive Operating Pressure for the Discharge Side	MPa	4.3	4.3
	Permissible Excessive Operating Pressure for the Suction Side	MPa	2.5	2.5
	Sound Pressure Level	dB (A)	51	51
	Sound Power Level	dB (A)	62	64
Dimension(WXHXD)	mm	732X550X330	732X550X330	
Dimension of Carton Box (LXWXH)	mm	789X390X600	789X390X600	
Dimension of Package(LXWXH)	mm	792X393X615	792X393X615	
Net Weight	kg	25	25	
Gross Weight	kg	27.5	27.5	
Refrigerant		R32	R32	
Refrigerant Charge	kg	0.5	0.55	
Connection Pipe	Connection Pipe Length	m	5	5
	Connection Pipe Gas Additional Charge	g/m	16	16
	Outer Diameter Liquid Pipe	inch	1/4	1/4
	Outer Diameter Gas Pipe	inch	3/8	3/8
	Max Distance Height	m	10	10
	Max Distance Length	m	15	15
Note: The connection pipe applies metric diameter.				

The above data is subject to change without notice. Please refer to the nameplate of the unit.

Model			1.GWH09ACC-K6DNA1F 2.GWH09ACC-K6DNA3F	1.GWH09ACC-K6DNA1F 2.GWH09ACC-K6DNA2F 3.GWH09ACC-K6DNA3F 4.GWH09ACC-K6DNA5F	
Product Code			1.CB497016000/CB497016001/ CB497016002 2.CB343004700	1.CB497016003/CB497016004/ CB497016006/CB497016007/ CB497016009 2.CB342002501 3.CB343004701 4.CB341004501	
Power Supply	Rated Voltage	V~	220-240	220-240	
	Rated Frequency	Hz	50	50	
	Phases		1	1	
Power Supply Mode			Outdoor	Outdoor	
Cooling Capacity		W	2700	2700	
Heating Capacity		W	3000	3000	
Cooling Power Input		W	695	695	
Heating Power Input		W	700	700	
Cooling Current Input		A	3.1	3.1	
Heating Current Input		A	3.2	3.2	
Rated Input		W	1400	1400	
Rated Cooling Current		A	6	6	
Rated Heating Current		A	6.2	6.2	
Air Flow Volume		m <sup>3</sup> /h	610/570/540/470/440/420/390	610/570/540/470/440/420/390	
Dehumidifying Volume		L/h	1.69	1.69	
EER		W/W	3.885	3.88	
COP		W/W	4.286	4.29	
SEER			7.5	7.5	
SCOP(Average/WarmerColder)			4.2/5.3/3.4	4.2/5.3/3.4	
Application Area		m <sup>2</sup>	12-18	12-18	
Indoor Unit	Model		1.GWH09ACC-K6DNA1F/I 2.GWH09ACC-K6DNA3F/I	1.GWH09ACC-K6DNA1F/I 2.GWH09ACC-K6DNA2F/I 3.GWH09ACC-K6DNA3F/I 4.GWH09ACC-K6DNA5F/I	
	Product Code		1.CB497N16000/CB497N16001/ CB497N16002 2.CB343N04700	1.CB497N16000/CB497N16002/ CB497N16006/CB497N16007/ CB497N16009 2.CB342N02500 3.CB343N04700 4.CB341N04500	
	Fan Type			Cross-flow	Cross-flow
	Fan Diameter Length(DXL)		mm	Φ98×633.5	Φ98×633.5
	Cooling Speed		r/min	1200/1100/1050/950/900/850/800	1200/1100/1050/950/900/850/800
	Heating Speed		r/min	1150/1100/1050/1000/950/900/850	1150/1100/1050/1000/950/900/850
	Fan Motor Power Output		W	20	20
	Fan Motor RLA		A	0.31	0.31
	Fan Motor Capacitor		μF	1.5	1.5
	Evaporator Form			Aluminum Fin-copper Tube	Aluminum Fin-copper Tube
	Evaporator Pipe Diameter		mm	Φ5	Φ5
	Evaporator Row-fin Gap		mm	2-1.4	2-1.4
	Evaporator Coil Length (LXDXW)		mm	635×22.8×306.3	635×22.8×306.3
	Swing Motor Model			MP24EB/MP24HF	MP24EB/MP24HF
	Swing Motor Power Output		W	1.5/1.5	1.5/1.5
	Fuse Current		A	3.15	3.15
	Sound Pressure Level		dB (A)	Cooling:38/36/34/31/29/27/25 Heating:38/37/35/34/32/29/28	Cooling:38/36/34/31/29/27/25 Heating:38/37/35/34/32/29/28
	Sound Power Level		dB (A)	Cooling:54/48/46/43/41/39/37 Heating:56/49/47/46/44/41/40	Cooling:54/48/46/43/41/39/37 Heating:56/49/47/46/44/41/40
	Dimension (WXHXD)		mm	889X294X212	889X294X212
	Dimension of Carton Box (LXWXH)		mm	935X349X273	935X349X273
Dimension of Package (LXWXH)		mm	940X365X284	940X365X284	
Net Weight		kg	11	11	
Gross Weight		kg	13	13	

Outdoor Unit	Outdoor Unit Model		GWH09AFC-K6DNA2F/O	GWH09AFC-K6DNA2F/O
	Outdoor Unit Product Code		CB363W02900	CB363W02901
	Compressor Manufacturer		ZHUHAI LANDA COMPRESSOR CO., LTD.	ZHUHAI LANDA COMPRESSOR CO., LTD.
	Compressor Model		QXF-A082zC170	QXF-A082zC170
	Compressor Oil		ZE-G;ES RB68GX or equivalent	ZE-G;ES RB68GX or equivalent
	Compressor Type		Rotary	Rotary
	Compressor LRA.	A	15	15
	Compressor RLA	A	2.56	2.56
	Compressor Power Input	W	756.6	756.6
	Compressor Overload Protector		/	/
	Throttling Method		Capillary	Capillary
	Set Temperature Range	°C	16~30	16~30
	Cooling Operation Ambient Temperature Range	°C	-15~50	-15~50
	Heating Operation Ambient Temperature Range	°C	-15~30	-25~30
	Condenser Form		Aluminum Fin-copper Tube	Aluminum Fin-copper Tube
	Condenser Pipe Diameter	mm	Φ7	Φ7
	Condenser Rows-fin Gap	mm	1-1.2	1-1.2
	Condenser Coil Length (LXDXW)	mm	666×19.05×527	666×19.05×527
	Fan Motor Speed	rpm	900	900
	Fan Motor Power Output	W	30	30
	Fan Motor RLA	A	0.4	0.4
	Fan Motor Capacitor	μF	/	/
	Outdoor Unit Air Flow Volume	m <sup>3</sup> /h	1950	1950
	Fan Type		Axial-flow	Axial-flow
	Fan Diameter	mm	Φ400	Φ400
	Defrosting Method		Automatic Defrosting	Automatic Defrosting
	Climate Type		T1	T1
	Isolation		I	I
	Moisture Protection		IPX4	IPX4
	Permissible Excessive Operating Pressure for the Discharge Side	MPa	4.3	4.3
	Permissible Excessive Operating Pressure for the Suction Side	MPa	2.5	2.5
	Sound Pressure Level	dB (A)	50	50
Sound Power Level	dB (A)	61	61	
Dimension(WXHXD)	mm	732X555X330	732X555X330	
Dimension of Carton Box (LXWXH)	mm	791X373X590	791X373X590	
Dimension of Package(LXWXH)	mm	794X376X615	794X376X615	
Net Weight	kg	24.5	24.5	
Gross Weight	kg	27	27	
Refrigerant		R32	R32	
Refrigerant Charge	kg	0.53	0.53	
Connection Pipe	Connection Pipe Length	m	5	5
	Connection Pipe Gas Additional Charge	g/m	16	16
	Outer Diameter Liquid Pipe	inch	1/4	1/4
	Outer Diameter Gas Pipe	inch	3/8	3/8
	Max Distance Height	m	10	10
	Max Distance Length	m	15	15
Note: The connection pipe applies metric diameter.				

The above data is subject to change without notice. Please refer to the nameplate of the unit.



Model			1.GWH12ACC-K6DNA1F 2.GWH12ACC-K6DNA2F 3.GWH12ACC-K6DNA3F 4.GWH12ACCXB-K6DNA4F 5.GWH12ACC-K6DNA5F	1.GWH12ACC-K6DNA1F 2.GWH12ACC-K6DNA3F
Product Code			1.CB497015800/CB497015807/ CB497015806/CB497015809/ CB497015811 2.CB342002700 3.CB343004600 4.CB344003301 5.CB341002901	1.CB497015801/CB497015802/ CB497015803 2.CB343004601
Power Supply	Rated Voltage	V~	220-240	220-240
	Rated Frequency	Hz	50	50
	Phases		1	1
Power Supply Mode			Outdoor	Outdoor
Cooling Capacity		W	3510	3510
Heating Capacity		W	3810	3810
Cooling Power Input		W	962	962
Heating Power Input		W	953	953
Cooling Current Input		A	4.3	4.3
Heating Current Input		A	4.6	4.6
Rated Input		W	1550	1550
Rated Cooling Current		A	6.2	6.2
Rated Heating Current		A	6.9	6.9
Air Flow Volume		m <sup>3</sup> /h	700/650/600/540/480/420/360/300	700/650/600/540/480/420/360/300
Dehumidifying Volume		L/h	1.4	1.4
EER		W/W	3.65	3.65
COP			4	4
SEER			7.1	7.1
SCOP(Average/WarmerColder)		W/W	4.1/5.2/3.1	4.1/5.2/3.1
Application Area		m <sup>2</sup>	16-24	16-24
Indoor Unit	Model		1.GWH12ACC-K6DNA1F/I 2.GWH12ACC-K6DNA2F/I 3.GWH12ACC-K6DNA3F/I 4.GWH12ACCXB-K6DNA4F/I 5.GWH12ACC-K6DNA5F/I	1.GWH12ACC-K6DNA1F/I 2.GWH12ACC-K6DNA3F/I
	Product Code		1.CB497N15800/CB497N15802/ CB497N15803/CB497N15809/ CB497N15811 2.CB342N02700 3.CB343N04600 4.CB344N03301 5.CB341N02901	1.CB497N15800/CB497N15802/ CB497N15803 2.CB343N04600
	Fan Type		Cross-flow	Cross-flow
	Fan Diameter Length(DXL)	mm	Φ98×633.5	Φ98×633.5
	Cooling Speed	r/min	1350/1200/1100/1000/920/850/800	1350/1200/1100/1000/920/850/800
	Heating Speed	r/min	1300/1200/1120/1050/980/900/850	1300/1200/1120/1050/980/900/850
	Fan Motor Power Output	W	20	20
	Fan Motor RLA	A	0.31	0.31
	Fan Motor Capacitor	μF	1.5	1.5
	Evaporator Form		Aluminum Fin-copper Tube	Aluminum Fin-copper Tube
	Evaporator Pipe Diameter	mm	Φ5	Φ5
	Evaporator Row-fin Gap	mm	2-1.4	2-1.4
	Evaporator Coil Length (LXD <sub>XW</sub> )	mm	635×22.8×306.3	635×22.8×306.3
	Swing Motor Model		MP24EB/MP24HF	MP24EB/MP24HF
	Swing Motor Power Output	W	1.5/1.5	1.5/1.5
	Fuse Current	A	3.15	3.15
	Sound Pressure Level	dB (A)	Cooling:42/38/35/32/29/27/25 Heating:42/38/36/34/32/30/28	Cooling:42/38/35/32/29/26/25 Heating:42/38/36/34/32/30/28
	Sound Power Level	dB (A)	Cooling:57/50/47/44/41/39/37 Heating:52/48/46/44/42/40/38	Cooling:57/50/47/44/41/38/37 Heating:52/48/46/44/42/40/38
	Dimension (WXHXD)	mm	889X294X212	889X294X212
	Dimension of Carton Box (LXWXH)	mm	935X349X273	935X349X273
Dimension of Package (LXWXH)	mm	940X365X284	940X365X284	
Net Weight	kg	11	11	
Gross Weight	kg	13	13	



Outdoor Unit	Outdoor Unit Model		GWH12AFC-K6DNA2F/O	GWH12AFC-K6DNA2F/O
	Outdoor Unit Product Code		CB363W03600	CB363W03601
	Compressor Manufacturer		ZHUHAI LANDA COMPRESSOR CO., LTD.	ZHUHAI LANDA COMPRESSOR CO., LTD.
	Compressor Model		FTz-AN108ACBD	FTz-AN108ACBD
	Compressor Oil		FW68DA or equivalent	FW68DA or equivalent
	Compressor Type		Rotary	Rotary
	Compressor LRA.	A	/	/
	Compressor RLA	A	4.4	4.4
	Compressor Power Input	W	/	/
	Compressor Overload Protector		/	/
	Throttling Method		Electron expansion valve	Electron expansion valve
	Set Temperature Range	°C	16~30	16~30
	Cooling Operation Ambient Temperature Range	°C	-15~50	-15~50
	Heating Operation Ambient Temperature Range	°C	-25~30	-15~30
	Condenser Form		Aluminum Fin-copper Tube	Aluminum Fin-copper Tube
	Condenser Pipe Diameter	mm	Φ7.94	Φ7.94
	Condenser Rows-fin Gap	mm	1-1.2	1-1.2
	Condenser Coil Length (LXDXW)	mm	666×19.05×527	666×19.05×527
	Fan Motor Speed	rpm	900	900
	Fan Motor Power Output	W	30	30
	Fan Motor RLA	A	0.4	0.4
	Fan Motor Capacitor	μF	/	/
	Outdoor Unit Air Flow Volume	m <sup>3</sup> /h	1950	1950
	Fan Type		Axial-flow	Axial-flow
	Fan Diameter	mm	Φ400	Φ400
	Defrosting Method		Automatic Defrosting	Automatic Defrosting
	Climate Type		T1	T1
	Isolation		I	I
	Moisture Protection		IPX4	IPX4
	Permissible Excessive Operating Pressure for the Discharge Side	MPa	4.3	4.3
	Permissible Excessive Operating Pressure for the Suction Side	MPa	2.5	2.5
	Sound Pressure Level	dB (A)	52	52
	Sound Power Level	dB (A)	63	63
Dimension(WXHXD)	mm	732X555X330	732X555X330	
Dimension of Carton Box (LXWXH)	mm	791X373X590	791X373X590	
Dimension of Package(LXWXH)	mm	794X376X605	794X376X605	
Net Weight	kg	24.5	24.5	
Gross Weight	kg	27	27	
Refrigerant		R32	R32	
Refrigerant Charge	kg	0.57	0.57	
Connection Pipe	Connection Pipe Length	m	5	5
	Connection Pipe Gas Additional Charge	g/m	16	16
	Outer Diameter Liquid Pipe	inch	1/4	1/4
	Outer Diameter Gas Pipe	inch	3/8	3/8
	Max Distance Height	m	10	10
	Max Distance Length	m	15	15
Note: The connection pipe applies metric diameter.				

The above data is subject to change without notice. Please refer to the nameplate of the unit.

Model			GWH09ACCXB-K6DNA3C	GWH12ACCXD-K6DNA3B
Product Code			CB343005301	CB343005401
Power Supply	Rated Voltage	V~	220-240	220-240
	Rated Frequency	Hz	50	50
	Phases		1	1
Power Supply Mode			Outdoor	Outdoor
Cooling Capacity		W	2700	3500
Heating Capacity		W	3000	3810
Cooling Power Input		W	600	875
Heating Power Input		W	680	952
Cooling Current Input		A	3.1	4.1
Heating Current Input		A	3.7	4.5
Rated Input		W	1600	1850
Rated Cooling Current		A	6.3	7.3
Rated Heating Current		A	7.1	8
Air Flow Volume		m <sup>3</sup> /h	660/590/540/490/450/420/390/180	680/590/540/490/450/420/390/180
Dehumidifying Volume		L/h	0.8	1.4
EER		W/W	4.5	4
COP		W/W	4.412	4
SEER			9	8.5
SCOP(Average/WarmerColder)			/	/
Application Area		m <sup>2</sup>	12-18	16-24
Indoor Unit	Model		GWH09ACCXB-K6DNA3C/I	GWH12ACCXD-K6DNA3B/I
	Product Code		CB343N05300	CB343N05400
	Fan Type		Cross-flow	Cross-flow
	Fan Diameter Length(DXL)	mm	Φ98×633	Φ98×633
	Cooling Speed	r/min	1300/1150/1070/1000/850/700/650/500	1350/1200/1120/1050/950/850/750/500
	Heating Speed	r/min	1250/1100/1050/1000/950/900/850	1350/1200/1140/1080/1020/960/900
	Fan Motor Power Output	W	20	20
	Fan Motor RLA	A	0.09	0.09
	Fan Motor Capacitor	μF	/	/
	Evaporator Form		Aluminum Fin-copper Tube	Aluminum Fin-copper Tube
	Evaporator Pipe Diameter	mm	Φ5	Φ5
	Evaporator Row-fin Gap	mm	2-1.4	2-1.4
	Evaporator Coil Length (LXDXW)	mm	635×22.8×306.3	635×22.8×306.3
	Swing Motor Model		MP24EB/MP24HF	MP24EB/MP24HF
	Swing Motor Power Output	W	1.5/1.5	1.5/1.5
	Fuse Current	A	3.15	3.15
	Sound Pressure Level	dB (A)	Cooling:41/38/36/34/30/26/22/19 Heating:41/38/36/34/32/30/28	Cooling:43/39/37/35/32/29/23/19 Heating:43/39/38/36/33/31/29
	Sound Power Level	dB (A)	Cooling:58/52/50/48/44/40/36/33 Heating:58/52/50/48/46/44/42	Cooling:58/53/51/49/46/43/37/33 Heating:58/53/52/50/47/45/43
	Dimension (WXHXD)	mm	889X294X212	889X294X212
	Dimension of Carton Box (LXWXH)	mm	935X349X273	935X349X273
Dimension of Package (LXWXH)	mm	940X365X284	940X365X284	
Net Weight	kg	10.5	10.5	
Gross Weight	kg	12.5	12.5	

Outdoor Unit	Outdoor Unit Model		GWH09YCXB-K6DNA1C/O	GWH12YCXD-K6DNA1B/O
	Outdoor Unit Product Code		CB437W04901	CB437W04501
	Compressor Manufacturer		ZHUHAI LANDA COMPRESSOR CO., LTD.	ZHUHAI LANDA COMPRESSOR CO., LTD.
	Compressor Model		QXF-A082zC170	FTz-AN108ACBD
	Compressor Oil		ZE-G;ES RB68GX or equivalent	FW68DA or equivalent
	Compressor Type		Rotary	Rotary
	Compressor LRA.	A	15	/
	Compressor RLA	A	2.56	4.4
	Compressor Power Input	W	756.6	/
	Compressor Overload Protector		/	/
	Throttling Method		Electron expansion valve	Electron expansion valve
	Set Temperature Range	°C	16~30	16~30
	Cooling Operation Ambient Temperature Range	°C	-15~50	-15~50
	Heating Operation Ambient Temperature Range	°C	-25~30	-25~30
	Condenser Form		Aluminum Fin-copper Tube	Aluminum Fin-copper Tube
	Condenser Pipe Diameter	mm	Φ7	Φ7
	Condenser Rows-fin Gap	mm	2-1.4	2-1.4
	Condenser Coil Length (LXD <sub>XW</sub> )	mm	666×38.1×527	761.5×38.1×528
	Fan Motor Speed	rpm	850	850
	Fan Motor Power Output	W	30	30
	Fan Motor RLA	A	0.4	0.4
	Fan Motor Capacitor	μF	/	/
	Outdoor Unit Air Flow Volume	m <sup>3</sup> /h	1950	2200
	Fan Type		Axial-flow	Axial-flow
	Fan Diameter	mm	Φ400	Φ420
	Defrosting Method		Automatic Defrosting	Automatic Defrosting
	Climate Type		T1	T1
	Isolation		I	I
	Moisture Protection		IPX4	IPX4
	Permissible Excessive Operating Pressure for the Discharge Side	MPa	4.3	4.3
	Permissible Excessive Operating Pressure for the Suction Side	MPa	2.5	2.5
	Sound Pressure Level	dB (A)	50	52
	Sound Power Level	dB (A)	62	64
Dimension(WXHXD)	mm	732X555X330	802X555X350	
Dimension of Carton Box (LXWXH)	mm	791X373X590	869X395X594	
Dimension of Package(LXWXH)	mm	794X376X615	872X398X620	
Net Weight	kg	27	29	
Gross Weight	kg	29.5	31.5	
Refrigerant		R32	R32	
Refrigerant Charge	kg	0.7	0.8	
Connection Pipe	Connection Pipe Length	m	5	5
	Connection Pipe Gas Additional Charge	g/m	16	16
	Outer Diameter Liquid Pipe	inch	1/4	1/4
	Outer Diameter Gas Pipe	inch	3/8	3/8
	Max Distance Height	m	10	10
	Max Distance Length	m	15	20
Note: The connection pipe applies metric diameter.				

The above data is subject to change without notice. Please refer to the nameplate of the unit.

Model			GWH18ACDXF-K6DNA3B	
Product Code			CB343005501	
Power Supply	Rated Voltage	V~	220-240	
	Rated Frequency	Hz	50	
	Phases		1	
Power Supply Mode			Outdoor	
Cooling Capacity		W	5300	
Heating Capacity		W	5600	
Cooling Power Input		W	1413	
Heating Power Input		W	1333	
Cooling Current Input		A	6.5	
Heating Current Input		A	6.2	
Rated Input		W	2500	
Rated Cooling Current		A	11.5	
Rated Heating Current		A	12.5	
Air Flow Volume		m <sup>3</sup> /h	850/750/680/610/570/520/460	
Dehumidifying Volume		L/h	1.8	
EER		W/W	3.75	
COP		W/W	4.2	
SEER			7.6	
SCOP(Average/WarmerColder)			/	
Application Area		m <sup>2</sup>	23-34	
Indoor Unit	Model		GWH18ACDXF-K6DNA3B/I	
	Product Code		CB343N05500	
	Fan Type		Cross-flow	
	Fan Diameter Length(DXL)		mm	Φ106×706
	Cooling Speed		r/min	1230/1170/1100/1020/960/880/800/550
	Heating Speed		r/min	1400/1270/1200/1130/1050/980/900
	Fan Motor Power Output		W	45
	Fan Motor RLA		A	0.24
	Fan Motor Capacitor		μF	/
	Evaporator Form			Aluminum Fin-copper Tube
	Evaporator Pipe Diameter		mm	Φ7
	Evaporator Row-fin Gap		mm	2-1.4
	Evaporator Coil Length (LXDXW)		mm	715×25.4×304.8
	Swing Motor Model			MP35CJ/MP24HF
	Swing Motor Power Output		W	2.5/1.5
	Fuse Current		A	3.15
	Sound Pressure Level		dB (A)	Cooling:43/41/39/37/35/32/31/21 Heating:47/45/42/40/38/36/33
	Sound Power Level		dB (A)	Cooling:60/57/55/54/52/50/46/34 Heating:60/58/57/56/54/52/48
	Dimension (WXHXD)		mm	1013X307X221
	Dimension of Carton Box (LXWXH)		mm	1055X366X287
Dimension of Package (LXWXH)		mm	1060X374X297	
Net Weight		kg	13	
Gross Weight		kg	16	

Outdoor Unit	Outdoor Unit Model		GWH18YDXF-K6DNA1B/O
	Outdoor Unit Product Code		CB437W04801
	Compressor Manufacturer		ZHUHAI LANDA COMPRESSOR CO., LTD.
	Compressor Model		FTz-SM151AXB
	Compressor Oil		FW68DA or equivalent
	Compressor Type		Rotary
	Compressor LRA	A	18
	Compressor RLA	A	6.06
	Compressor Power Input	W	1330
	Compressor Overload Protector		/
	Throttling Method		Electron expansion valve
	Set Temperature Range	°C	16~30
	Cooling Operation Ambient Temperature Range	°C	-15~50
	Heating Operation Ambient Temperature Range	°C	-25~30
	Condenser Form		Aluminum Fin-copper Tube
	Condenser Pipe Diameter	mm	Φ7
	Condenser Rows-fin Gap	mm	2-1.4
	Condenser Coil Length (LXDXW)	mm	839×38.1×616
	Fan Motor Speed	rpm	800
	Fan Motor Power Output	W	60
	Fan Motor RLA	A	0.65
	Fan Motor Capacitor	μF	/
	Outdoor Unit Air Flow Volume	m <sup>3</sup> /h	3600
	Fan Type		Axial-flow
	Fan Diameter	mm	Φ520
	Defrosting Method		Automatic Defrosting
	Climate Type		T1
	Isolation		I
	Moisture Protection		IPX4
	Permissible Excessive Operating Pressure for the Discharge Side	MPa	4.3
	Permissible Excessive Operating Pressure for the Suction Side	MPa	2.5
	Sound Pressure Level	dB (A)	57
	Sound Power Level	dB (A)	64
Dimension(WXHxD)	mm	958X660X402	
Dimension of Carton Box (LXWXH)	mm	1029X453X715	
Dimension of Package(LXWXH)	mm	1032X456X737	
Net Weight	kg	42	
Gross Weight	kg	46.5	
Refrigerant		R32	
Refrigerant Charge	kg	1	
Connection Pipe	Connection Pipe Length	m	5
	Connection Pipe Gas Additional Charge	g/m	16
	Outer Diameter Liquid Pipe	inch	1/4
	Outer Diameter Gas Pipe	inch	1/2
	Max Distance Height	m	10
	Max Distance Length	m	25
	Note: The connection pipe applies metric diameter.		

The above data is subject to change without notice. Please refer to the nameplate of the unit.

Model			GWH18ACD-K6DNA1I GWH18ACD-K6DNA5I GWH18ACDXD-K6DNA4I
Product Code			CB497016207/CB497016209 CB341003301 CB344002901
Power Supply	Rated Voltage	V~	220-240
	Rated Frequency	Hz	50
	Phases		1
Power Supply Mode			Outdoor
Cooling Capacity		W	5200
Heating Capacity		W	5600
Cooling Power Input		W	1576
Heating Power Input		W	1436
Cooling Current Input		A	7.1
Heating Current Input		A	6.3
Rated Input		W	2400
Rated Cooling Current		A	10.5
Rated Heating Current		A	11
Air Flow Volume		m <sup>3</sup> /h	850/750/680/610/570/520/460
Dehumidifying Volume		L/h	1.9
EER		W/W	3.3
COP		W/W	/
SEER			7.1
SCOP(Average/WarmerColder)			4.2/5.7/3.4
Application Area		m <sup>2</sup>	23-34
Indoor Unit	Model		GWH18ACD-K6DNA1I/I GWH18ACD-K6DNA5I/I GWH18ACDXD-K6DNA4I/I
	Product Code		CB497N16207/CB497N16209 CB341N03300 CB344N02900
	Fan Type		Cross-flow
	Fan Diameter Length(DXL)	mm	Φ106×706
	Cooling Speed	r/min	1230/1170/1100/1020/960/880/800/550
	Heating Speed	r/min	1400/1270/1200/1130/1050/980/900
	Fan Motor Power Output	W	45
	Fan Motor RLA	A	0.24
	Fan Motor Capacitor	μF	/
	Evaporator Form		Aluminum Fin-copper Tube
	Evaporator Pipe Diameter	mm	Φ7
	Evaporator Row-fin Gap	mm	2-1.4
	Evaporator Coil Length (LXDXW)	mm	715×25.4×304.8
	Swing Motor Model		MP35CJ
	Swing Motor Power Output	W	2.5
	Fuse Current	A	3.15
	Sound Pressure Level	dB (A)	Cooling:44/43/41/38/36/34/30/23 Heating:48/45/42/40/38/36/33
	Sound Power Level	dB (A)	Cooling:60/56/54/51/49/47/43/36 Heating:60/58/55/53/51/49/46
	Dimension (WXHXD)	mm	1013X307X221
	Dimension of Carton Box (LXWXH)	mm	1055X366X287
Dimension of Package (LXWXH)	mm	1060X374X297	
Net Weight	kg	13.5	
Gross Weight	kg	16	

Outdoor Unit	Outdoor Unit Model		GWH18AFD-K6DNA2I/O	
	Outdoor Unit Product Code		CB363W04201	
	Compressor Manufacturer		ZHUHAI LANDA COMPRESSOR CO., LTD.	
	Compressor Model		QXF-A120zH170A	
	Compressor Oil		FW68DA or equivalent	
	Compressor Type		Rotary	
	Compressor LRA.	A		18
	Compressor RLA	A		5
	Compressor Power Input	W		1096
	Compressor Overload Protector			HPC115/95U1/KSD115°C
	Throttling Method			Electron expansion valve
	Set Temperature Range	°C		16~30
	Cooling Operation Ambient Temperature Range	°C		-15~50
	Heating Operation Ambient Temperature Range	°C		-25~30
	Condenser Form			Aluminum Fin-copper Tube
	Condenser Pipe Diameter	mm		Φ7
	Condenser Rows-fin Gap	mm		2-1.4
	Condenser Coil Length (LXD <sub>XW</sub> )	mm		895×38.1×528
	Fan Motor Speed	rpm		880
	Fan Motor Power Output	W		30
	Fan Motor RLA	A		0.4
	Fan Motor Capacitor	μF		/
	Outdoor Unit Air Flow Volume	m <sup>3</sup> /h		2200
	Fan Type			Axial-flow
	Fan Diameter	mm		Φ420
	Defrosting Method			Automatic Defrosting
	Climate Type			T1
	Isolation			I
	Moisture Protection			IPX4
	Permissible Excessive Operating Pressure for the Discharge Side	MPa		4.3
	Permissible Excessive Operating Pressure for the Suction Side	MPa		2.5
	Sound Pressure Level	dB (A)		56
	Sound Power Level	dB (A)		65
Dimension(WXH <sub>XD</sub> )	mm		802X555X350	
Dimension of Carton Box (LXWXH)	mm		869X395X594	
Dimension of Package(LXWXH)	mm		872X398X620	
Net Weight	kg		30.5	
Gross Weight	kg		33	
Refrigerant			R32	
Refrigerant Charge	kg		0.82	
Connection Pipe	Connection Pipe Length	m	5	
	Connection Pipe Gas Additional Charge	g/m	16	
	Outer Diameter Liquid Pipe	inch	1/4	
	Outer Diameter Gas Pipe	inch	1/2	
	Max Distance Height	m	10	
	Max Distance Length	m	25	
	Note: The connection pipe applies metric diameter.			

The above data is subject to change without notice. Please refer to the nameplate of the unit.



Model			GWH18ACD-K6DNA1I	1.GWH18ACD-K6DNA1I 2.GWH18ACD-K6DNA2I 3.GWH18ACDXD-K6DNA3I 4.GWH18ACDXD-K6DNA4I 5.GWH18ACD-K6DNA5I
Product Code			CB497016200/CB497016206/ CB497016205	1.CB497016201/CB497016202/ CB497016203/CB497016204/ CB497016208 2.CB342002801 3.CB343006001 4.CB344002902 5.CB341003302
Power Supply	Rated Voltage	V~	220-240	220-240
	Rated Frequency	Hz	50	50
	Phases		1	1
Power Supply Mode			Outdoor	Outdoor
Cooling Capacity		W	5200	5200
Heating Capacity		W	5600	5600
Cooling Power Input		W	1576	1576
Heating Power Input		W	1436	1436
Cooling Current Input		A	7.1	7.1
Heating Current Input		A	6.3	6.3
Rated Input		W	2400	2400
Rated Cooling Current		A	10.5	10.5
Rated Heating Current		A	11	11
Air Flow Volume		m <sup>3</sup> /h	850/750/680/610/570/520/460	850/750/680/610/570/520/460
Dehumidifying Volume		L/h	1.9	1.9
EER		W/W	3.3	3.3
COP		W/W	3.9	/
SEER			7.1	7.1
SCOP(Average/WarmerColder)			4.2/5.7/3.4	4.2/5.7/3.4
Application Area		m <sup>2</sup>	23-34	23-34
Indoor Unit	Model		GWH18ACD-K6DNA1I/I	1.GWH18ACD-K6DNA1I/I 2.GWH18ACD-K6DNA2I/I 3.GWH18ACDXD-K6DNA3I/I 4.GWH18ACDXD-K6DNA4I/I 5.GWH18ACD-K6DNA5I/I
	Product Code		CB497N16200/CB497N16202 CB497N16204	1.CB497N16200/CB497N16202/ CB497N16203/CB497N16204/ CB497N16208 2.CB342N02800 3.CB343N06000 4.CB344N02902 5.CB341N03302
	Fan Type		Cross-flow	Cross-flow
	Fan Diameter Length(DXL)	mm	Φ106×706	Φ106×706
	Cooling Speed	r/min	1230/1170/1100/1020/960/880/800/550	1230/1170/1100/1020/960/880/800/550
	Heating Speed	r/min	1400/1270/1200/1130/1050/980/900	1400/1270/1200/1130/1050/980/900
	Fan Motor Power Output	W	45	45
	Fan Motor RLA	A	0.24	0.24
	Fan Motor Capacitor	μF	/	/
	Evaporator Form		Aluminum Fin-copper Tube	Aluminum Fin-copper Tube
	Evaporator Pipe Diameter	mm	Φ7	Φ7
	Evaporator Row-fin Gap	mm	2-1.4	2-1.4
	Evaporator Coil Length (LXDXW)	mm	715×25.4×304.8	715×25.4×304.8
	Swing Motor Model		MP35CJ/MP24HF	MP35CJ/MP24HF
	Swing Motor Power Output	W	2.5/1.5	2.5/1.5
	Fuse Current	A	3.15	3.15
	Sound Pressure Level	dB (A)	Cooling:44/43/41/38/36/34/30/23 Heating:48/45/42/40/38/36/33	Cooling:44/43/41/38/36/34/30/23 Heating:48/45/42/40/38/36/33
	Sound Power Level	dB (A)	Cooling:60/56/54/51/49/47/43/36 Heating:60/58/55/53/51/49/46	Cooling:60/56/54/51/49/47/43/36 Heating:60/58/55/53/51/49/46
	Dimension (WXHXD)	mm	1013X307X221	1013X307X221
	Dimension of Carton Box (LXWXH)	mm	1055X366X287	1055X366X287
	Dimension of Package (LXWXH)	mm	1060X374X297	1060X374X297
	Net Weight	kg	13.5	13.5
	Gross Weight	kg	16	16



Outdoor Unit	Outdoor Unit Model		GWH18AFD-K6DNA2I/O	GWH18AFD-K6DNA2I/O
	Outdoor Unit Product Code		CB363W04200	CB363W04201
	Compressor Manufacturer		ZHUHAI LANDA COMPRESSOR CO., LTD.	ZHUHAI LANDA COMPRESSOR CO., LTD.
	Compressor Model		QXF-A120zH170A	QXF-A120zH170A
	Compressor Oil		FW68DA or equivalent	FW68DA or equivalent
	Compressor Type		Rotary	Rotary
	Compressor LRA.	A	18	18
	Compressor RLA	A	5	5
	Compressor Power Input	W	1096	1096
	Compressor Overload Protector		HPC115/95U1/KSD115°C	HPC115/95U1/KSD115°C
	Throttling Method		Electron expansion valve	Electron expansion valve
	Set Temperature Range	°C	16~30	16~30
	Cooling Operation Ambient Temperature Range	°C	-15~50	-15~50
	Heating Operation Ambient Temperature Range	°C	-15~30	-25~30
	Condenser Form		Aluminum Fin-copper Tube	Aluminum Fin-copper Tube
	Condenser Pipe Diameter	mm	Φ7	Φ7
	Condenser Rows-fin Gap	mm	2-1.4	2-1.4
	Condenser Coil Length (LXDXW)	mm	895×38.1×528	895×38.1×528
	Fan Motor Speed	rpm	880	880
	Fan Motor Power Output	W	30	30
	Fan Motor RLA	A	0.4	0.4
	Fan Motor Capacitor	μF	/	/
	Outdoor Unit Air Flow Volume	m <sup>3</sup> /h	2200	2200
	Fan Type		Axial-flow	Axial-flow
	Fan Diameter	mm	Φ420	Φ420
	Defrosting Method		Automatic Defrosting	Automatic Defrosting
	Climate Type		T1	T1
	Isolation		I	I
	Moisture Protection		IPX4	IPX4
	Permissible Excessive Operating Pressure for the Discharge Side	MPa	4.3	4.3
	Permissible Excessive Operating Pressure for the Suction Side	MPa	2.5	2.5
	Sound Pressure Level	dB (A)	56	56
Sound Power Level	dB (A)	65	65	
Dimension(WXHXD)	mm	802X555X350	802X555X350	
Dimension of Carton Box (LXWXH)	mm	869X395X594	869X395X594	
Dimension of Package(LXWXH)	mm	872X398X620	872X398X620	
Net Weight	kg	30.5	30.5	
Gross Weight	kg	33	33	
Refrigerant		R32	R32	
Refrigerant Charge	kg	0.82	0.82	
Connection Pipe	Connection Pipe Length	m	5	5
	Connection Pipe Gas Additional Charge	g/m	16	16
	Outer Diameter Liquid Pipe	inch	1/4	1/4
	Outer Diameter Gas Pipe	inch	1/2	1/2
	Max Distance Height	m	10	10
	Max Distance Length	m	25	25
Note: The connection pipe applies metric diameter.				

The above data is subject to change without notice. Please refer to the nameplate of the unit.

Model			GWH18ACDXF-K6DNA1A GWH18ACDXF-K6DNA3A	GWH18ACDXF-K6DNA1A
Product Code			CB497016900 CB343004500	CB497016901/CB497016902/ CB497016903/CB497016904/ CB497016905
Power Supply	Rated Voltage	V~	220-240	220-240
	Rated Frequency	Hz	50	50
	Phases		1	1
Power Supply Mode			Outdoor	Outdoor
Cooling Capacity		W	5300	5300
Heating Capacity		W	5600	5600
Cooling Power Input		W	1413	1413
Heating Power Input		W	1333	1333
Cooling Current Input		A	6.5	6.5
Heating Current Input		A	6.2	6.2
Rated Input		W	2500	2500
Rated Cooling Current		A	11.5	11.5
Rated Heating Current		A	12.5	12.5
Air Flow Volume		m <sup>3</sup> /h	850/750/680/610/570/520/460	850/750/680/610/570/520/460
Dehumidifying Volume		L/h	1.9	1.9
EER		W/W	3.75	3.75
COP		W/W	4.20	4.20
SEER			7.6	7.6
SCOP(Average/WarmerColder)			4.3/5.8/3.5	4.3/5.8/3.5
Application Area		m <sup>2</sup>	23-34	23-34
Indoor Unit	Model		GWH18ACDXF-K6DNA1A/I GWH18ACDXF-K6DNA3A/I	GWH18ACDXF-K6DNA1A/I
	Product Code		CB497N16900 CB343N04500	CB497N16900/CB497N16902/ CB497N16903/CB497N16904/ CB497N16905
	Fan Type		Cross-flow	Cross-flow
	Fan Diameter Length(DXL)	mm	Φ106×706	Φ106×706
	Cooling Speed	r/min	1230/1170/1100/1020/960/880/800/550	1230/1170/1100/1020/960/880/800/550
	Heating Speed	r/min	1400/1270/1200/1130/1050/980/900	1400/1270/1200/1130/1050/980/900
	Fan Motor Power Output	W	45	45
	Fan Motor RLA	A	0.24	0.24
	Fan Motor Capacitor	μF	/	/
	Evaporator Form		Aluminum Fin-copper Tube	Aluminum Fin-copper Tube
	Evaporator Pipe Diameter	mm	Φ7	Φ7
	Evaporator Row-fin Gap	mm	2-1.4	2-1.4
	Evaporator Coil Length (LXDXW)	mm	715×25.4×304.8	715×25.4×304.8
	Swing Motor Model		MP35CJ/MP24HF	MP35CJ/MP24HF
	Swing Motor Power Output	W	2.5/1.5	2.5/1.5
	Fuse Current	A	3.15	3.15
	Sound Pressure Level	dB (A)	Cooling:43/41/39/37/35/32/31/21 Heating:47/45/42/40/38/36/33	Cooling:43/41/39/37/35/32/31/21 Heating:47/45/42/40/38/36/33
	Sound Power Level	dB (A)	Cooling:60/57/55/54/52/50/46/34 Heating:60/58/57/56/54/52/48	Cooling:60/57/55/54/52/50/46/34 Heating:60/58/57/56/54/52/48
	Dimension (WXHXD)	mm	1013X307X221	1013X307X221
	Dimension of Carton Box (LXWXH)	mm	1055X366X287	1055X366X287
Dimension of Package (LXWXH)	mm	1060X374X297	1060X374X297	
Net Weight	kg	13	13	
Gross Weight	kg	15.5	15.5	

Outdoor Unit	Outdoor Unit Model		GWH18ACDXF-K6DNA1A/O	GWH18ACDXF-K6DNA1A/O
	Outdoor Unit Product Code		CB497W16900	CB497W16901
	Compressor Manufacturer		ZHUHAI LANDA COMPRESSOR CO., LTD.	ZHUHAI LANDA COMPRESSOR CO., LTD.
	Compressor Model		FTz-SM151AXBD	FTz-SM151AXBD
	Compressor Oil		FW68DA or equivalent	FW68DA or equivalent
	Compressor Type		Rotary	Rotary
	Compressor LRA.	A	18	18
	Compressor RLA	A	6.06	6.06
	Compressor Power Input	W	1330	1330
	Compressor Overload Protector		/	/
	Throttling Method		Electron expansion valve	Electron expansion valve
	Set Temperature Range	°C	16~30	16~30
	Cooling Operation Ambient Temperature Range	°C	-15~50	-15~50
	Heating Operation Ambient Temperature Range	°C	-15~30	-25~30
	Condenser Form		Aluminum Fin-copper Tube	Aluminum Fin-copper Tube
	Condenser Pipe Diameter	mm	Φ7	Φ7
	Condenser Rows-fin Gap	mm	2-1.4	2-1.4
	Condenser Coil Length (LXDXW)	mm	839×38.1×616	839×38.1×616
	Fan Motor Speed	rpm	800	800
	Fan Motor Power Output	W	60	60
	Fan Motor RLA	A	0.65	0.65
	Fan Motor Capacitor	μF	/	/
	Outdoor Unit Air Flow Volume	m <sup>3</sup> /h	3600	3600
	Fan Type		Axial-flow	Axial-flow
	Fan Diameter	mm	Φ520	Φ520
	Defrosting Method		Automatic Defrosting	Automatic Defrosting
	Climate Type		T1	T1
	Isolation		I	I
	Moisture Protection		IPX4	IPX4
	Permissible Excessive Operating Pressure for the Discharge Side	MPa	4.3	4.3
	Permissible Excessive Operating Pressure for the Suction Side	MPa	2.5	2.5
	Sound Pressure Level	dB (A)	57	57
	Sound Power Level	dB (A)	64	64
Dimension(WXHXD)	mm	958X660X402	958X660X402	
Dimension of Carton Box (LXWXH)	mm	1029X453X715	1029X453X715	
Dimension of Package(LXWXH)	mm	1032X456X737	1032X456X737	
Net Weight	kg	40.5	40.5	
Gross Weight	kg	45	45	
Refrigerant		R32	R32	
Refrigerant Charge	kg	1	1	
Connection Pipe	Connection Pipe Length	m	5	5
	Connection Pipe Gas Additional Charge	g/m	16	16
	Outer Diameter Liquid Pipe	inch	1/4	1/4
	Outer Diameter Gas Pipe	inch	1/2	1/2
	Max Distance Height	m	10	10
	Max Distance Length	m	25	25
Note: The connection pipe applies metric diameter.				

The above data is subject to change without notice. Please refer to the nameplate of the unit.

Model			GWH24ACE-K6DNA1I GWH24ACEXF-K6DNA4I
Product Code			CB497016107/CB497016109 CB344003001
Power Supply	Rated Voltage	V~	220-240
	Rated Frequency	Hz	50
	Phases		1
Power Supply Mode			Outdoor
Cooling Capacity		W	7100
Heating Capacity		W	7800
Cooling Power Input		W	2030
Heating Power Input		W	2000
Cooling Current Input		A	9
Heating Current Input		A	9.3
Rated Input		W	3000
Rated Cooling Current		A	13
Rated Heating Current		A	13.5
Air Flow Volume		m <sup>3</sup> /h	1250/1100/1000/950/900/850/800/600
Dehumidifying Volume		L/h	2.4
EER		W/W	3.5
COP		W/W	3.9
SEER			7
SCOP(Average/WarmerColder)			4.2/5.4/3.4
Application Area		m <sup>2</sup>	27-42
Indoor Unit	Model		GWH24ACE-K6DNA1I/I GWH24ACEXF-K6DNA4I/I
	Product Code		CB497N16107/CB497N16109 CB344N03000
	Fan Type		Cross-flow
	Fan Diameter Length(DXL)	mm	Φ108×830
	Cooling Speed	r/min	1250/1100/1000/950/900/850/800/600
	Heating Speed	r/min	1400/1250/1100/1050/1000/900/850
	Fan Motor Power Output	W	60
	Fan Motor RLA	A	0.24
	Fan Motor Capacitor	μF	/
	Evaporator Form		Aluminum Fin-copper Tube
	Evaporator Pipe Diameter	mm	Φ7
	Evaporator Row-fin Gap	mm	2-1.4
	Evaporator Coil Length (LXDXW)	mm	845×25.4×342.9
	Swing Motor Model		MP35CP
	Swing Motor Power Output	W	2.5
	Fuse Current	A	3.15
	Sound Pressure Level	dB (A)	Cooling:48/44/41/40/38/36/33/27 Heating:50/47/43/41/40/36/35
	Sound Power Level	dB (A)	Cooling:64/59/56/55/53/51/48/42 Heating:64/62/58/56/55/51/50
	Dimension (WXHXD)	mm	1122X329X247
	Dimension of Carton Box (LXWXH)	mm	1172X398X322
Dimension of Package (LXWXH)	mm	1177X406X332	
Net Weight	kg	16.5	
Gross Weight	kg	19.5	

Outdoor Unit	Outdoor Unit Model		GWH24AFE-K6DNA2I/O	
	Outdoor Unit Product Code		CB363W04101	
	Compressor Manufacturer		ZHUHAI LANDA COMPRESSOR CO., LTD.	
	Compressor Model		QXFS-M180zX170	
	Compressor Oil		FW68DA or equivalent	
	Compressor Type		Twin Rotary	
	Compressor LRA.	A		35
	Compressor RLA	A		3.5
	Compressor Power Input	W		1610
	Compressor Overload Protector			KSD115°C HPC 115/95U1
	Throttling Method			Electron expansion valve
	Set Temperature Range	°C		16~30
	Cooling Operation Ambient Temperature Range	°C		-15~50
	Heating Operation Ambient Temperature Range	°C		-25~30
	Condenser Form			Aluminum Fin-copper Tube
	Condenser Pipe Diameter	mm		Φ7
	Condenser Rows-fin Gap	mm		2-1.4
	Condenser Coil Length (LXDXW)	mm		839×38.1×616
	Fan Motor Speed	rpm		800
	Fan Motor Power Output	W		60
	Fan Motor RLA	A		0.25
	Fan Motor Capacitor	μF		/
	Outdoor Unit Air Flow Volume	m <sup>3</sup> /h		3600
	Fan Type			Axial-flow
	Fan Diameter	mm		Φ520
	Defrosting Method			Automatic Defrosting
	Climate Type			T1
	Isolation			I
	Moisture Protection			IPX4
	Permissible Excessive Operating Pressure for the Discharge Side	MPa		4.3
	Permissible Excessive Operating Pressure for the Suction Side	MPa		2.5
	Sound Pressure Level	dB (A)		59
	Sound Power Level	dB (A)		70
Dimension(WXHxD)	mm		958X660X402	
Dimension of Carton Box (LXWXH)	mm		1029X453X715	
Dimension of Package(LXWXH)	mm		1032X456X737	
Net Weight	kg		41.5	
Gross Weight	kg		46	
Refrigerant			R32	
Refrigerant Charge	kg		1.5	
Connection Pipe	Connection Pipe Length	m	5	
	Connection Pipe Gas Additional Charge	g/m	40	
	Outer Diameter Liquid Pipe	inch	1/4	
	Outer Diameter Gas Pipe	inch	5/8	
	Max Distance Height	m	10	
	Max Distance Length	m	25	
	Note: The connection pipe applies metric diameter.			

The above data is subject to change without notice. Please refer to the nameplate of the unit.

Model			1.GWH24ACE-K6DNA1I 2.GWH24ACE-K6DNA3J	1.GWH24ACE-K6DNA1I 2.GWH24ACE-K6DNA2I 3.GWH24ACE-K6DNA3J 4.GWH24ACEXF-K6DNA4I 5.GWH24ACE-K6DNA5I
Product Code			1.CB497016100/CB497016106/ CB497016105 2.CB343004400	1.CB497016101/CB497016102/ CB497016103/CB497016104/ CB497016108 2.CB342002601 3.CB343004401 4.CB344003002 5.CB341004601
Power Supply	Rated Voltage	V~	220-240	220-240
	Rated Frequency	Hz	50	50
	Phases		1	1
Power Supply Mode			Outdoor	Outdoor
Cooling Capacity		W	7100	7100
Heating Capacity		W	7800	7800
Cooling Power Input		W	2030	2030
Heating Power Input		W	2000	2000
Cooling Current Input		A	9	9
Heating Current Input		A	9.3	9.3
Rated Input		W	3000	3000
Rated Cooling Current		A	13	13
Rated Heating Current		A	13.5	13.5
Air Flow Volume		m <sup>3</sup> /h	1250/1100/1000/950/900/850/800/600	1250/1100/1000/950/900/850/800/600
Dehumidifying Volume		L/h	2.4	2.4
EER		W/W	3.5	3.5
COP		W/W	3.9	3.9
SEER			7	7
SCOP(Average/WarmerColder)			4.2/5.4/3.4	4.2/5.4/3.4
Application Area		m <sup>2</sup>	27-42	27-42
Indoor Unit	Model		1.GWH24ACE-K6DNA1I/I 2.GWH24ACE-K6DNA3J/I	1.GWH24ACE-K6DNA1I/I 2.GWH24ACE-K6DNA2I/I 3.GWH24ACE-K6DNA3J/I 4.GWH24ACEXF-K6DNA4I/I 5.GWH24ACE-K6DNA5I/I
	Product Code		1.CB497N16100/CB497N16102/ CB497N16104 2.CB343N04400	1.CB497N16100/CB497N16102/ CB497N16103/CB497N16104/ CB497N16108 2.CB342N02600 3.CB343N04400 4.CB344N03002 5.CB341N04600
	Fan Type		Cross-flow	Cross-flow
	Fan Diameter Length(DXL)	mm	Φ108×830	Φ108×830
	Cooling Speed	r/min	1250/1100/1000/950/900/850/800/600	1250/1100/1000/950/900/850/800/600
	Heating Speed	r/min	1400/1250/1100/1050/1000/900/850	1400/1250/1100/1050/1000/900/850
	Fan Motor Power Output	W	60	60
	Fan Motor RLA	A	0.24	0.24
	Fan Motor Capacitor	μF	/	/
	Evaporator Form		Aluminum Fin-copper Tube	Aluminum Fin-copper Tube
	Evaporator Pipe Diameter	mm	Φ7	Φ7
	Evaporator Row-fin Gap	mm	2-1.4	2-1.4
	Evaporator Coil Length (LXD <sub>X</sub> W)	mm	845×25.4×342.9	845×25.4×342.9
	Swing Motor Model		MP24HF/MP35CP	MP24HF/MP35CP
	Swing Motor Power Output	W	1.5/2.5	1.5/2.5
	Fuse Current	A	3.15	3.15
	Sound Pressure Level	dB (A)	Cooling:48/44/41/40/38/36/33/27 Heating:50/47/43/41/40/36/35	Cooling:48/44/41/40/38/36/33/27 Heating:50/47/43/41/40/36/35
	Sound Power Level	dB (A)	Cooling:64/59/56/55/53/51/48/42 Heating:64/62/58/56/55/51/50	Cooling:64/59/56/55/53/51/48/42 Heating:64/62/58/56/55/51/50
	Dimension (WXHXD)	mm	1122X329X247	1122X329X247
	Dimension of Carton Box (LXWXH)	mm	1172X398X322	1172X398X322
	Dimension of Package (LXWXH)	mm	1177X406X332	1177X406X332
	Net Weight	kg	16.5	16.5
	Gross Weight	kg	19.5	19.5

Outdoor Unit	Outdoor Unit Model		GWH24AFE-K6DNA2I/O	GWH24AFE-K6DNA2I/O
	Outdoor Unit Product Code		CB363W04100	CB363W04101
	Compressor Manufacturer		ZHUHAI LANDA COMPRESSOR CO., LTD.	ZHUHAI LANDA COMPRESSOR CO., LTD.
	Compressor Model		QXFS-M180zX170	QXFS-M180zX170
	Compressor Oil		FW68DA or equivalent	FW68DA or equivalent
	Compressor Type		Twin Rotary	Twin Rotary
	Compressor LRA.	A	35	35
	Compressor RLA	A	3.5	3.5
	Compressor Power Input	W	1610	1610
	Compressor Overload Protector		KSD115°C HPC 115/95U1	KSD115°C HPC 115/95U1
	Throttling Method		Electron expansion valve	Electron expansion valve
	Set Temperature Range	°C	16~30	16~30
	Cooling Operation Ambient Temperature Range	°C	-15~50	-15~50
	Heating Operation Ambient Temperature Range	°C	-15~30	-25~30
	Condenser Form		Aluminum Fin-copper Tube	Aluminum Fin-copper Tube
	Condenser Pipe Diameter	mm	Φ7	Φ7
	Condenser Rows-fin Gap	mm	2-1.4	2-1.4
	Condenser Coil Length (LXDXW)	mm	839×38.1×616	839×38.1×616
	Fan Motor Speed	rpm	800	800
	Fan Motor Power Output	W	60	60
	Fan Motor RLA	A	0.65	0.25
	Fan Motor Capacitor	μF	/	/
	Outdoor Unit Air Flow Volume	m <sup>3</sup> /h	3600	3600
	Fan Type		Axial-flow	Axial-flow
	Fan Diameter	mm	Φ520	Φ520
	Defrosting Method		Automatic Defrosting	Automatic Defrosting
	Climate Type		T1	T1
	Isolation		I	I
	Moisture Protection		IPX4	IPX4
	Permissible Excessive Operating Pressure for the Discharge Side	MPa	4.3	4.3
	Permissible Excessive Operating Pressure for the Suction Side	MPa	2.5	2.5
	Sound Pressure Level	dB (A)	59	59
	Sound Power Level	dB (A)	70	70
Dimension(WXHXD)	mm	958X660X402	958X660X402	
Dimension of Carton Box (LXWXH)	mm	1029X453X715	1029X453X715	
Dimension of Package(LXWXH)	mm	1032X456X737	1032X456X737	
Net Weight	kg	41.5	41.5	
Gross Weight	kg	46	46	
Refrigerant		R32	R32	
Refrigerant Charge	kg	1.5	1.5	
Connection Pipe	Connection Pipe Length	m	5	5
	Connection Pipe Gas Additional Charge	g/m	40	40
	Outer Diameter Liquid Pipe	inch	1/4	1/4
	Outer Diameter Gas Pipe	inch	5/8	5/8
	Max Distance Height	m	10	10
	Max Distance Length	m	25	25
Note: The connection pipe applies metric diameter.				

The above data is subject to change without notice. Please refer to the nameplate of the unit.



Model			GWH24ACD-K6DNA1B GWH24ACDXE-K6DNA3B GWH24ACDXE-K6DNA4B	1.GWH18ACDXB-K6DNA1E 2.GWH18ACDXB-K6DNA2E 3.GWH18ACDXB-K6DNA4A 4.GWH18ACDXB-K6DNA3A
Product Code			CB497020400 CB343004900 CB344003400	1.CB497020900/CB497020901/ CB497020902 2.CB342003600 3.CB344003100 4.CB343005200
Power Supply	Rated Voltage	V~	220-240	220-240
	Rated Frequency	Hz	50	50
	Phases		1	1
Power Supply Mode			Outdoor	Outdoor
Cooling Capacity		W	6200	4600
Heating Capacity		W	6500	5200
Cooling Power Input		W	1827	1355
Heating Power Input		W	1912	1340
Cooling Current Input		A	7.6	5.9
Heating Current Input		A	7.6	5.8
Rated Input		W	2300	1900
Rated Cooling Current		A	9.3	8
Rated Heating Current		A	10.2	9
Air Flow Volume		m <sup>3</sup> /h	900/800/600/400	850/800/700/600
Dehumidifying Volume		L/h	1.80	1.80
EER		W/W	3.40	3.39
COP		W/W	3.40	3.88
SEER			6.8	6.4
SCOP(Average/WarmerColder)			5.1/4/-	5.1/4/-
Application Area		m <sup>2</sup>	23-34	21-31
Indoor Unit	Model		GWH24ACD-K6DNA1B/I GWH24ACDXE-K6DNA3B/I GWH24ACDXE-K6DNA4B/I	1.GWH18ACDXB-K6DNA1E/I 2.GWH18ACDXB-K6DNA2E/I 3.GWH18ACDXB-K6DNA4A/I 4.GWH18ACDXB-K6DNA3A/I
	Product Code		CB497N20400 CB343N04900 CB344N03400	1.CB497N20900/CB497N20901/ CB497N20902 2.CB342N03600 3.CB344N03100 4.CB343N05200
	Fan Type		Cross-flow	Cross-flow
	Fan Diameter Length(DXL)	mm	Φ106×706	Φ106×706
	Cooling Speed	r/min	1400/1300/1000/800	1230/1170/1020/800
	Heating Speed	r/min	1400/1270/1000/700	1350/1270/1130/900
	Fan Motor Power Output	W	50	35
	Fan Motor RLA	A	0.24	0.45
	Fan Motor Capacitor	μF	/	2.5
	Evaporator Form		Aluminum Fin-copper Tube	Aluminum Fin-copper Tube
	Evaporator Pipe Diameter	mm	Φ7	Φ7
	Evaporator Row-fin Gap	mm	2-1.4	2-1.4
	Evaporator Coil Length (LXD <sub>X</sub> W)	mm	715X25.4X304.8	715X25.4X304.8
	Swing Motor Model		MP35CP	MP35CP
	Swing Motor Power Output	W	2.5	2.5
	Fuse Current	A	3.15	3.15
	Sound Pressure Level	dB (A)	Cooling:48/45/37/30 Heating:48/45/37/26	Cooling:44/42/38/31 Heating:48/46/41/34
	Sound Power Level	dB (A)	Cooling:58/55/47/40 Heating:58/55/47/36	Cooling:54/52/48/41 Heating:58/56/51/34
	Dimension (WXHXD)	mm	1013X307X221	1013X307X221
	Dimension of Carton Box (LXWXH)	mm	1055X366X287	1055X366X287
	Dimension of Package (LXWXH)	mm	1060X374X297	1060X374X297
Net Weight	kg	13	13.5	
Gross Weight	kg	15.5	16	



Outdoor Unit	Outdoor Unit Model		GWH24ALD-K6DNA1B/O	GWH18ALD-K6DNA1A/O
	Outdoor Unit Product Code		CB513W02200	CB513W01600
	Compressor Manufacturer		ZHUHAI LANDA COMPRESSOR CO., LTD.	ZHUHAI LANDA COMPRESSOR CO., LTD.
	Compressor Model		FTz-SM151AXBD	FTz-AN108ACBD
	Compressor Oil		FW68DA	FW68DA or equivalent
	Compressor Type		Rotary	Rotary
	Compressor LRA.	A	/	19
	Compressor RLA	A	6.06	4.4
	Compressor Power Input	W	1330	952
	Compressor Overload Protector		/	/
	Throttling Method		Capillary	Capillary
	Set Temperature Range	°C	16~30	16~30
	Cooling Operation Ambient Temperature Range	°C	-15~43	-15~43
	Heating Operation Ambient Temperature Range	°C	-15~24	-15~24
	Condenser Form		Aluminum Fin-copper Tube	Aluminum Fin-copper Tube
	Condenser Pipe Diameter	mm	Φ7.94	Φ7
	Condenser Rows-fin Gap	mm	2-1.4	1-1.4
	Condenser Coil Length (LXD <sub>X</sub> W)	mm	848x38.1x528	700x38.1x528
	Fan Motor Speed	rpm	900	900
	Fan Motor Power Output	W	40	30
	Fan Motor RLA	A	0.70	0.40
	Fan Motor Capacitor	μF	/	/
	Outdoor Unit Air Flow Volume	m <sup>3</sup> /h	3200	1950
	Fan Type		Axial-flow	Axial-flow
	Fan Diameter	mm	Φ445	Φ400
	Defrosting Method		Automatic Defrosting	Automatic Defrosting
	Climate Type		T1	T1
	Isolation		I	I
	Moisture Protection		IPX4	IPX4
	Permissible Excessive Operating Pressure for the Discharge Side	MPa	4.3	4.3
	Permissible Excessive Operating Pressure for the Suction Side	MPa	2.5	2.5
	Sound Pressure Level	dB (A)	57	55
	Sound Power Level	dB (A)	65	63
Dimension(WXHXD)	mm	873X555X376	732X555X330	
Dimension of Carton Box (LXWXH)	mm	948X428X591	791X373X590	
Dimension of Package(LXWXH)	mm	951X431X620	794X376X615	
Net Weight	kg	36.5	26.5	
Gross Weight	kg	39.5	29	
Refrigerant		R32	R32	
Refrigerant Charge	kg	1.23	0.75	
Connection Pipe	Connection Pipe Length	m	5	5
	Connection Pipe Gas Additional Charge	g/m	16	16
	Outer Diameter Liquid Pipe	inch	1/4	1/4
	Outer Diameter Gas Pipe	inch	1/2	3/8
	Max Distance Height	m	10	10
	Max Distance Length	m	25	25
Note: The connection pipe applies metric diameter.				

The above data is subject to change without notice. Please refer to the nameplate of the unit.

## 2.2 Capacity Variation Ratio According to Temperature

Heating operation ambient temperature range is -25°C~30°C

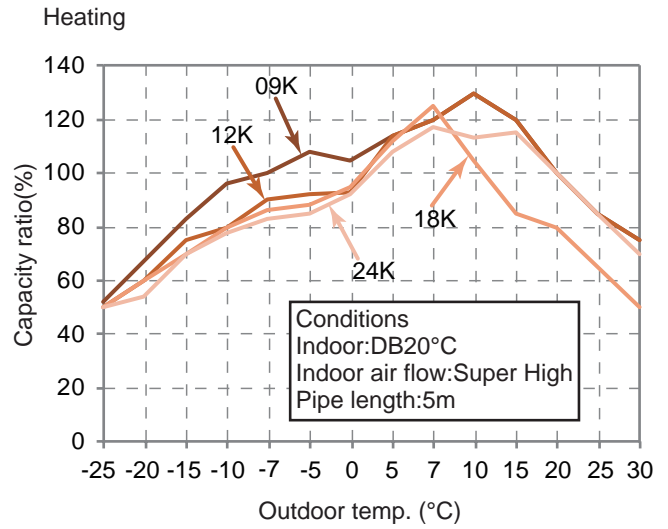
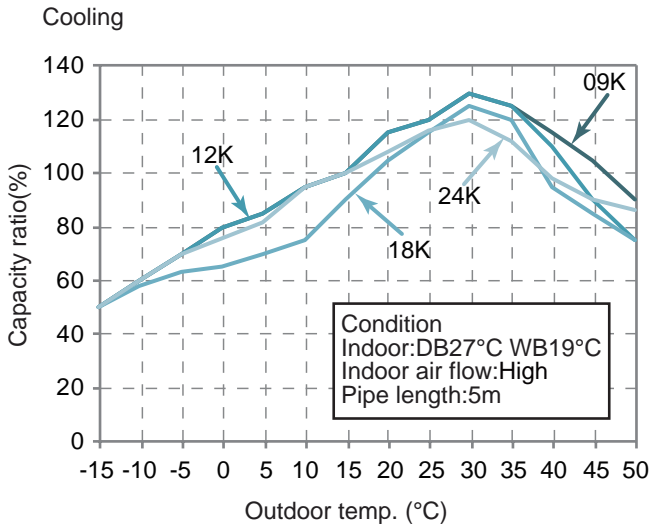

Heating operation ambient temperature range is -15°C~30°C

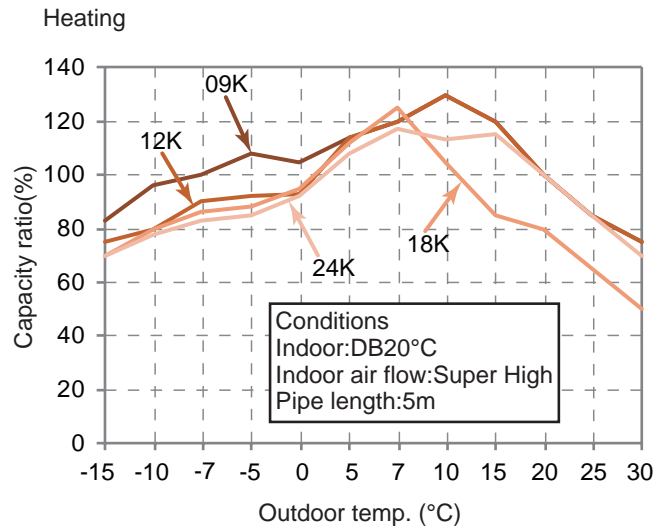
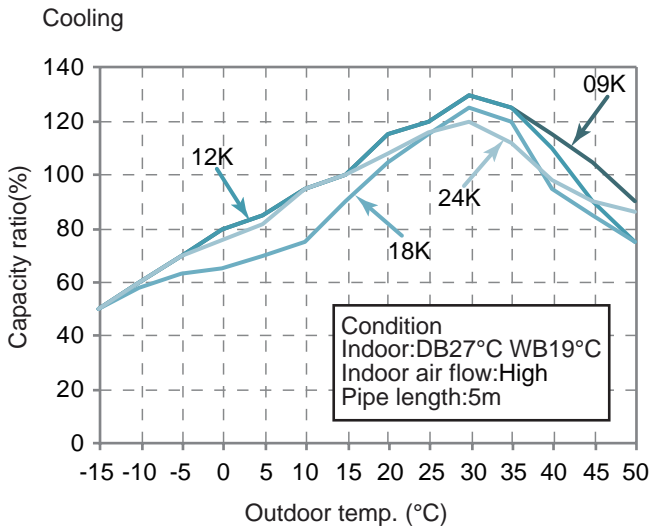

## 2.3 Cooling and Heating Data Sheet in Rated Frequency

Cooling:

Rated cooling condition(°C) (DB/WB)		Model	Pressure of gas pipe connecting indoor and outdoor unit	Inlet and outlet pipe temperature of heat exchanger		Fan speed of indoor unit	Fan speed of outdoor unit
Indoor	Outdoor			P (MPa)	T1 (°C)		
27/19	35/24	09K	0.8~1.1	12 ~ 15	65 ~ 38	Super High	High
27/19	35/24	12K	0.9~1.1	12 ~ 14	75 ~ 37	Super High	High
27/19	35/24	18K	0.9~1.1	12 ~ 14	75 ~ 37	Super High	High
27/19	35/24	24K	0.9~1.1	12 ~ 14	75 ~ 37	Super High	High

Heating:

Rated heating condition(°C) (DB/WB)		Model	Pressure of gas pipe connecting indoor and outdoor unit	Inlet and outlet pipe temperature of heat exchanger		Fan speed of indoor unit	Fan speed of outdoor unit
Indoor	Outdoor			P (MPa)	T1 (°C)		
20/-	7/6	09K	2.8~3.2	63 ~ 35	2 ~ 5	Super High	High
20/-	7/6	12K	2.2~2.4	70 ~ 35	2 ~ 4	Super High	High
20/-	7/6	18K	2.2~2.4	70 ~ 40	1 ~ 5	Super High	High
20/-	7/6	24K	2.2~2.4	70 ~ 35	2 ~ 4	Super High	High

**Instruction:**

T1: Inlet and outlet pipe temperature of evaporator

T2: Inlet and outlet pipe temperature of condenser

P: Pressure at the side of big valve

Connection pipe length: 5 m.

# 3. Outline Dimension Diagram

## 3.1 Indoor Unit

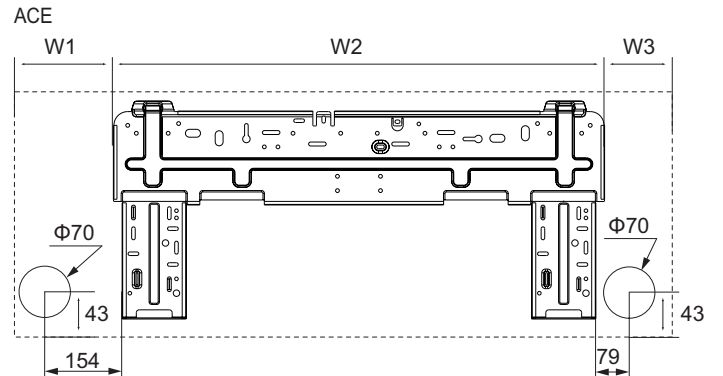
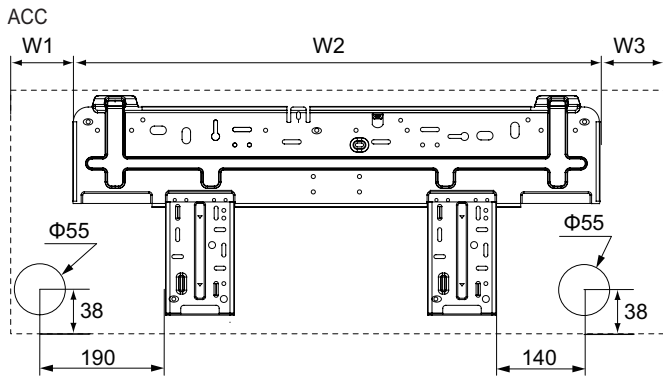
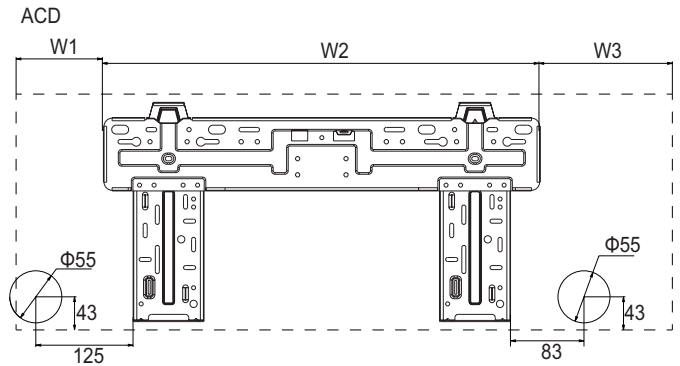
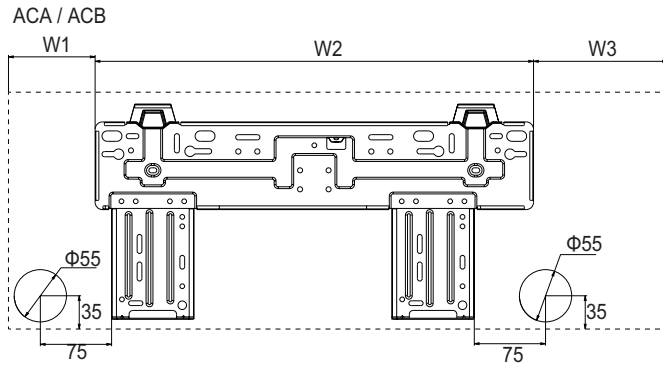
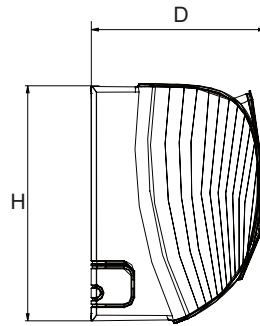
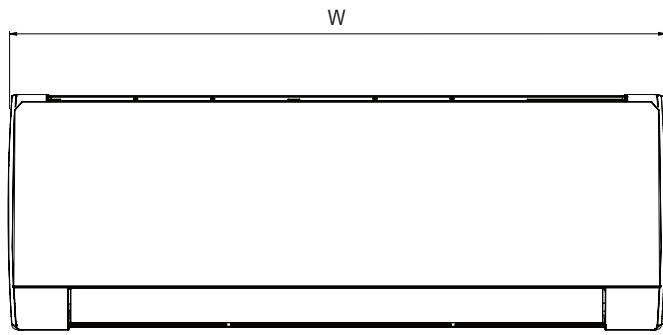

Model	W	H	D	W1	W2	W3
ACA	744	256	185	116	462	166
ACB	819	256	185	154	462	203
ACC	889	294	212	146	542	201
ACD	1013	307	221	125.5	685	202.5
ACE	1122	329	247	207	685	230

\* Recommended distance

## 3.2 Outdoor Unit

GWH07AGA-K6DNA1A/O

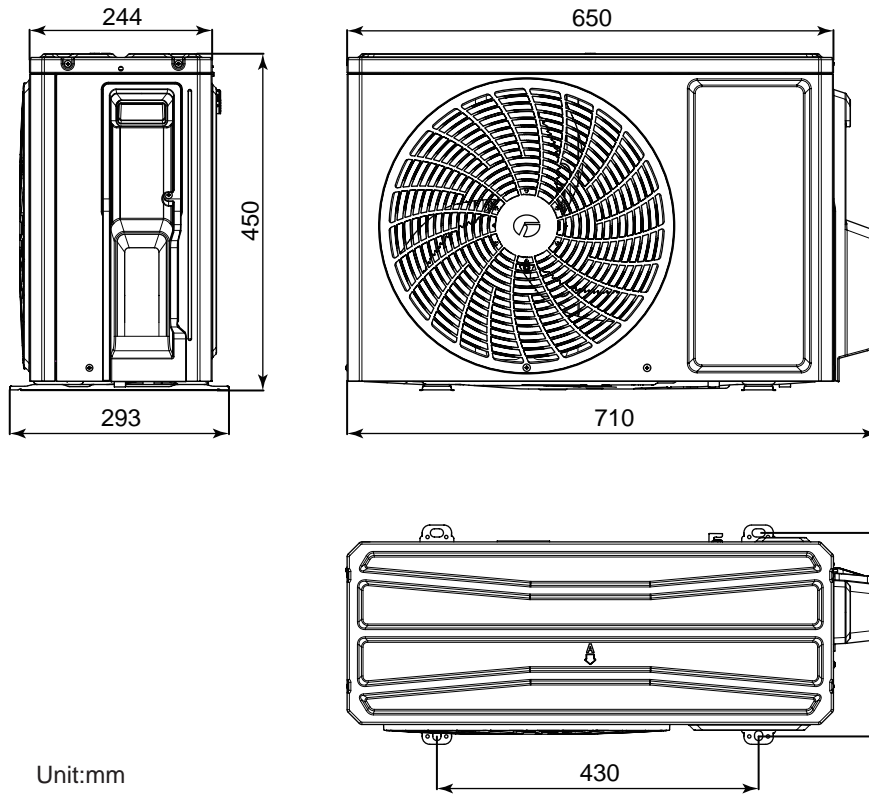

GWH12AGBXB-K6DNA1A/O

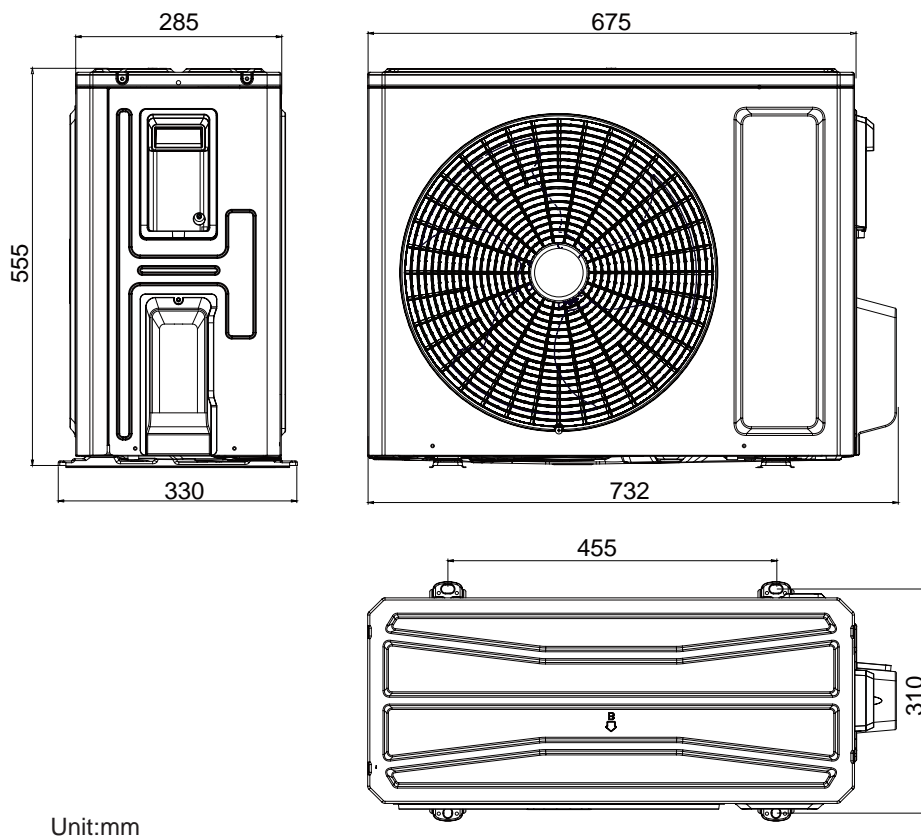

GWH09AGA-K6DNA1A/O

GWH12AGB-K6DNA1A/O

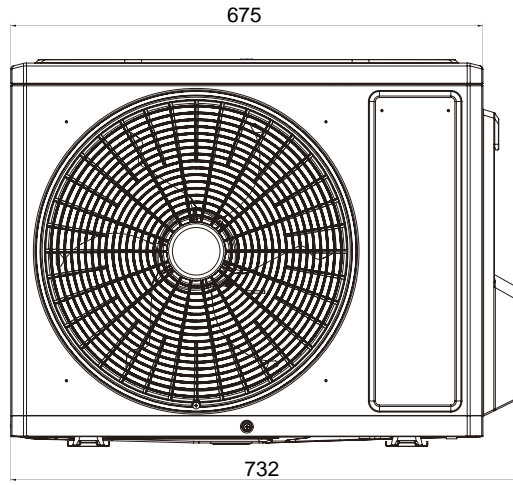
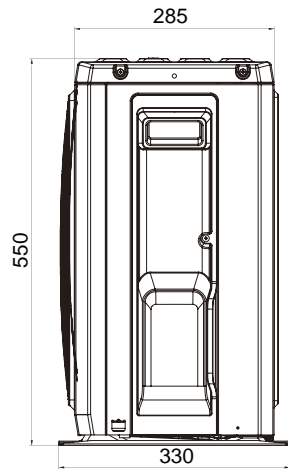

Unit:mm

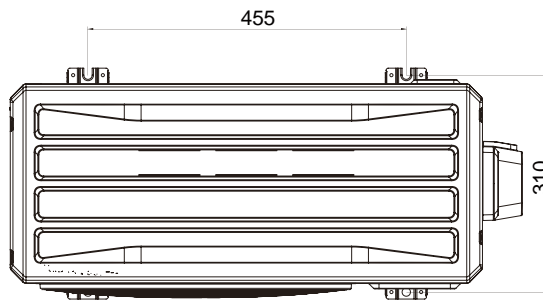

GWH09YCXB-K6DNA1C/O  
GWH18ALD-K6DNA1A/O

GWH09AFC-K6DNA2F/O

GWH09AGAXB-K6DNA1B/O

GWH12AFC-K6DNA2F/O

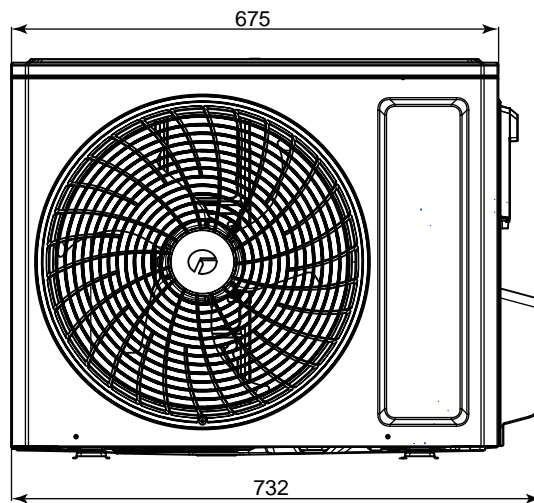
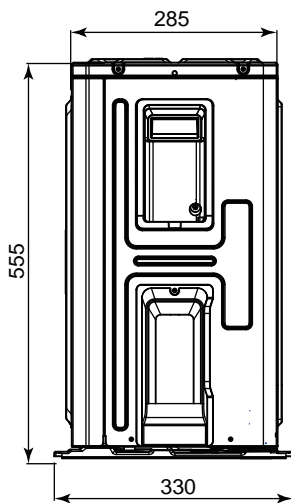

Unit:mm

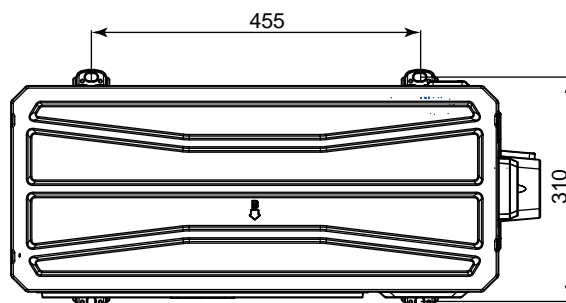

GWH12YCXD-K6DNA1B/O GWH18AFD-K6DNA2I/O

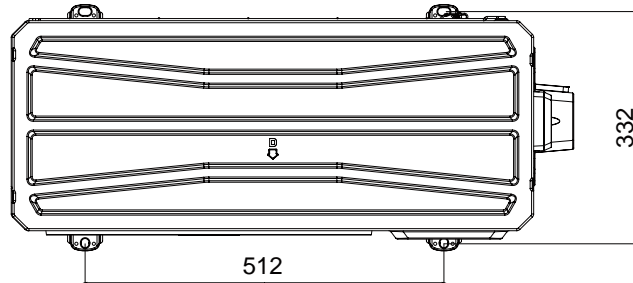
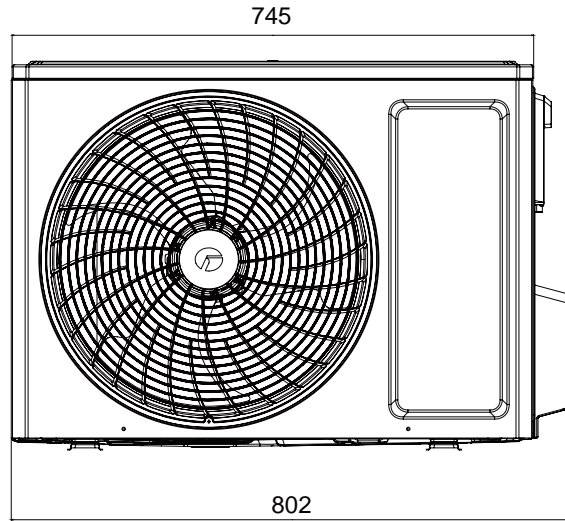
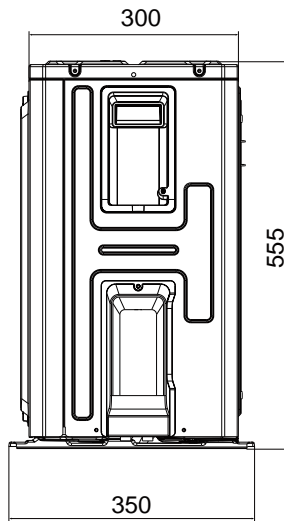

Unit:mm

GWH18ACDXF-K6DNA1A/O GWH18YDXF-K6DNA1B/O GWH24AFE-K6DNA2I/O

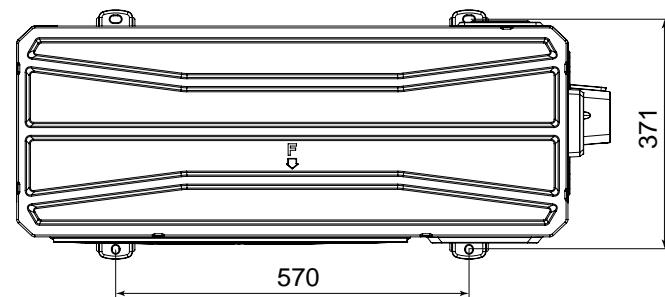
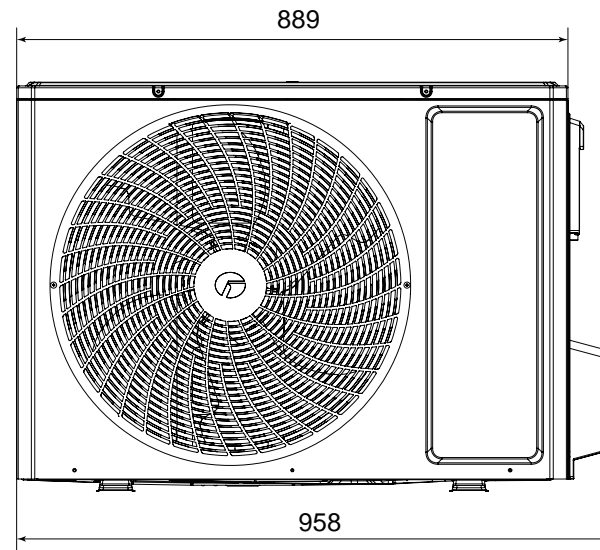
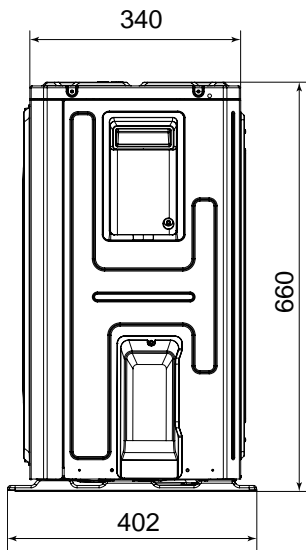

Unit:mm



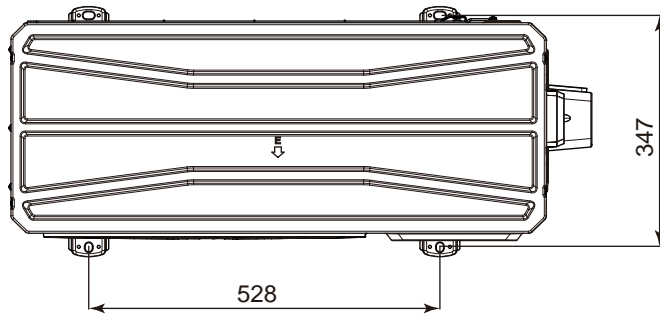
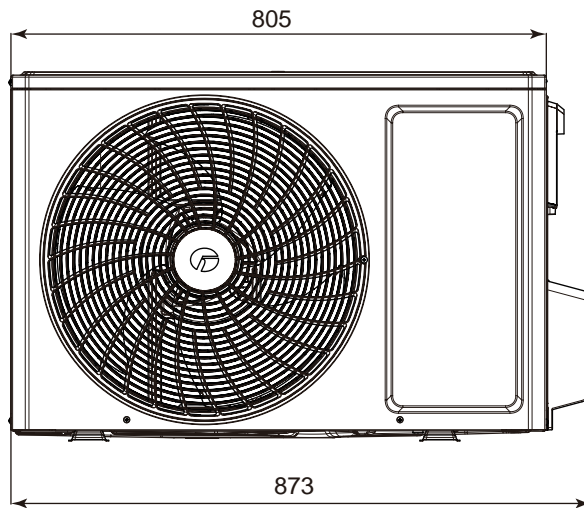
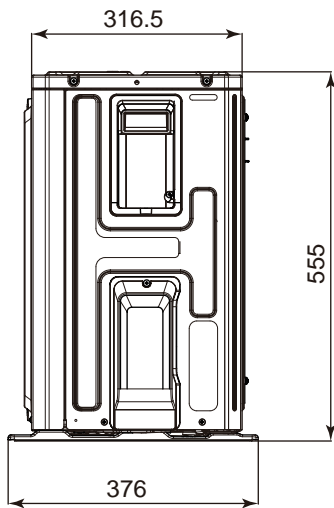

Unit:mm

# 4. Refrigerant System Diagram

07K  
 09K except: GWH09ACCXB-K6DNA3C  
 GWH12ACBXB-K6DNA4A      GWH18ACDXB-K6DNA1E      GWH18ACDXB-K6DNA2E      GWH18ACDXB-K6DNA3A  
 GWH18ACDXB-K6DNA4A      GWH24ACD-K6DNA1B

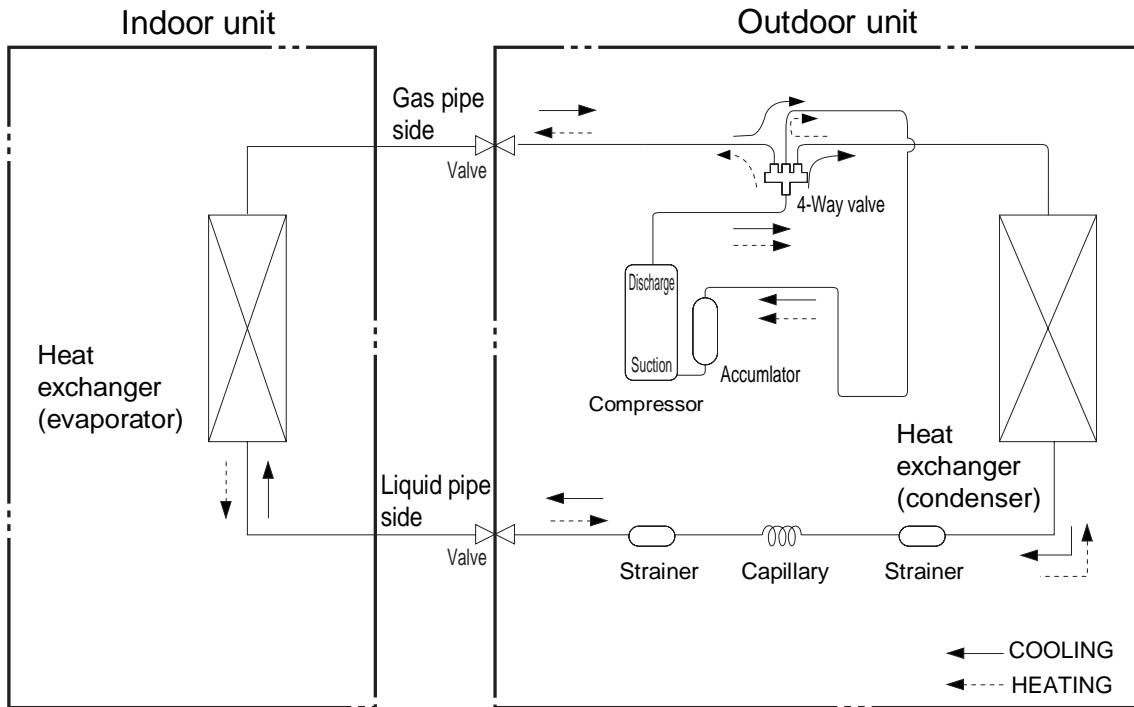

Connection pipe specification:  
 Liquid pipe: 1/4"  
 Gas pipe: 3/8" (07K / 09K / 18K)  
 1/2" (24K)

GWH09ACCXB-K6DNA3C  
 12K/18K/24K except:      GWH12ACBXB-K6DNA4A      GWH18ACDXB-K6DNA1E      GWH18ACDXB-K6DNA2E  
    GWH18ACDXB-K6DNA3A      GWH18ACDXB-K6DNA4A      GWH24ACD-K6DNA1B

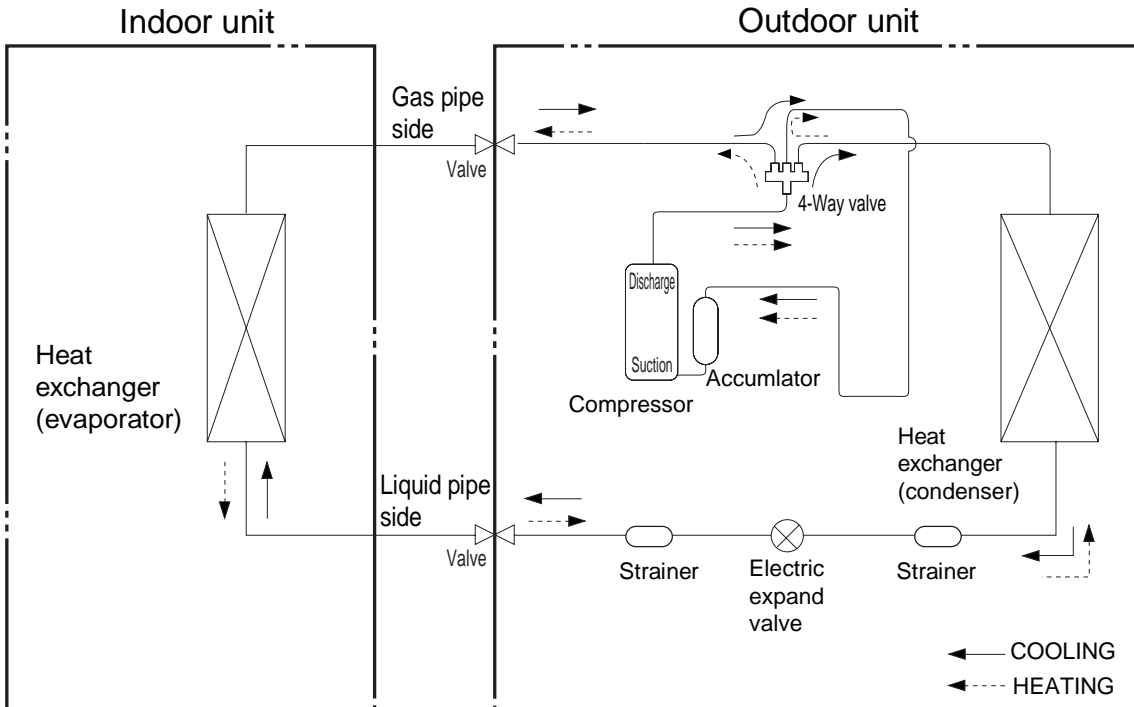

Connection pipe specification:  
 Liquid pipe: 1/4"  
 Gas pipe: 3/8" (09K / 12K)  
 1/2" (18K)  
 5/8" (24K)

# 5. Electrical Part

## 5.1 Wiring Diagram

### • Instruction

Symbol	Symbol Color	Symbol	Symbol Color	Symbol	Name
WH	White	GN	Green	CAP	Jumper cap
YE	Yellow	BN	Brown	COMP	Compressor
RD	Red	BU	Blue		Grounding wire
YEGN	Yellow/Green	BK	Black	/	/
VT	Violet	OG	Orange	/	/

Note: Jumper cap is used to determine fan speed and the swing angle of horizontal lever for this model.

### • Indoor Unit

GWH09ACC-K6DNA1F/I(CB497N16005/CB497N16010) GWH12ACC-K6DNA1F/I(CB497N15808/CB497N15812)  
GWH12ACC-K6DNA5F/I(CB341N02900)

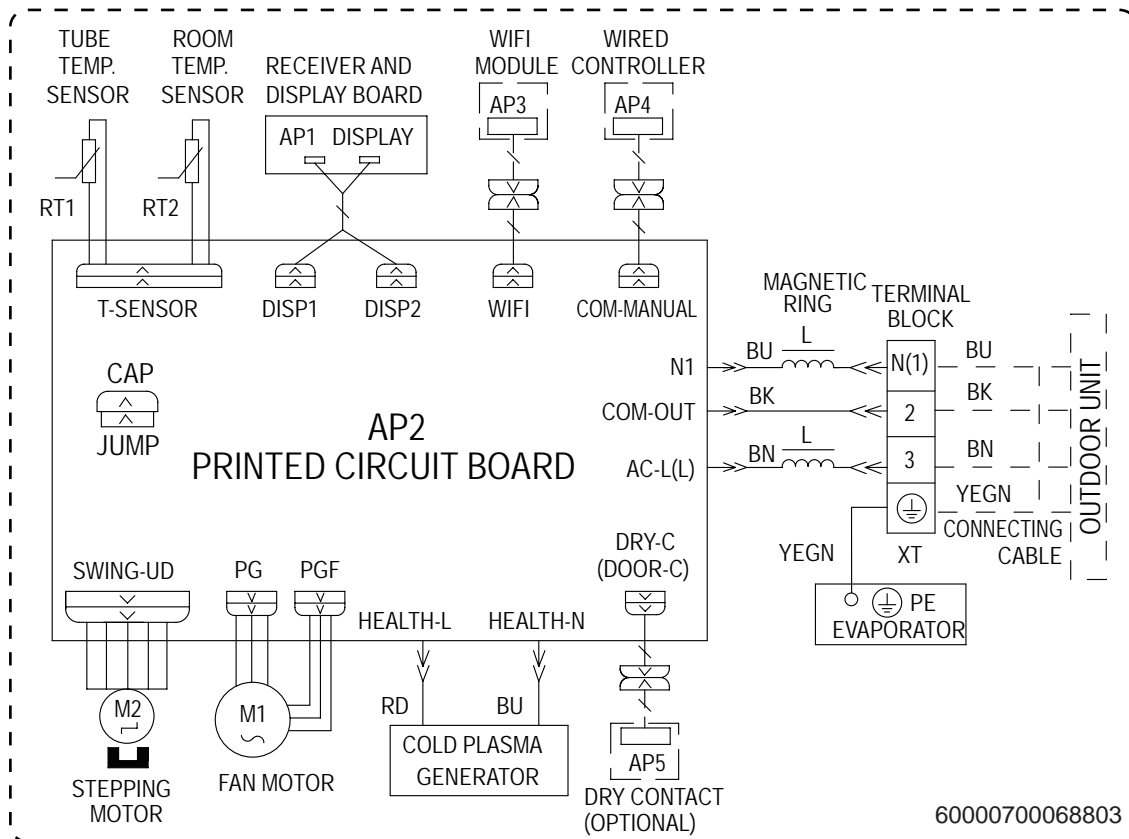

GWH09ACC-K6DNA1F/I(CB497N16000/CB497N16001/CB497N16002/CB497N16006/CB497N16007/CB497N16009)  
 GWH09ACC-K6DNA2F/I  
 GWH09ACC-K6DNA3F/I  
 GWH09ACC-K6DNA5F/I  
 GWH12ACC-K6DNA1F/I(CB497N15800/CB497N15802/CB497N15803/CB497N15809/CB497N15811)  
 GWH12ACC-K6DNA2F/I  
 GWH12ACC-K6DNA3F/I  
 GWH12ACCXB-K6DNA4F/I(CB344N03301)  
 GWH12ACC-K6DNA5F/I(CB341N02901)

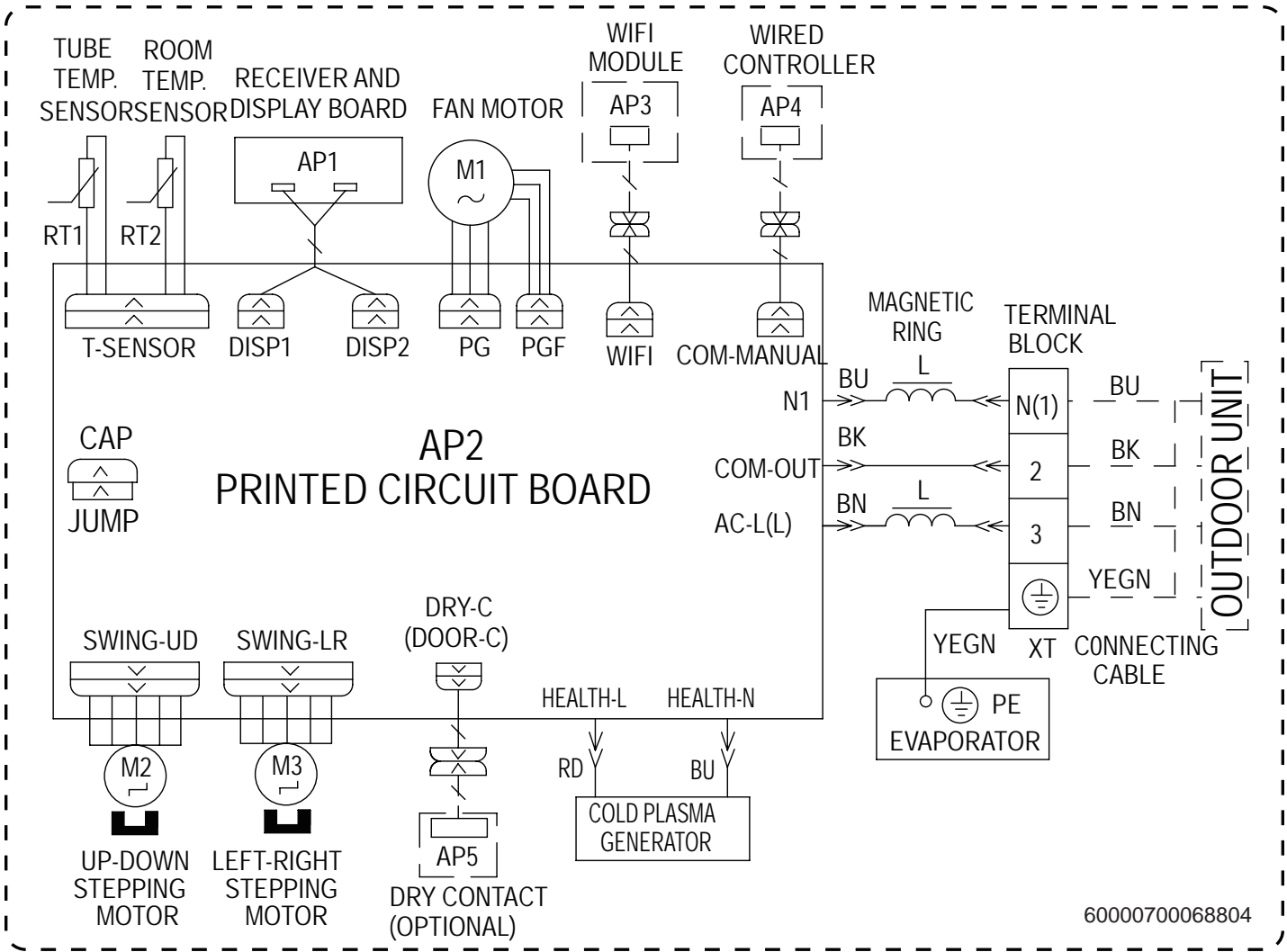

GWH18ACD-K6DNA1/I(CB497N16200/CB497N16202/CB497N16203/CB497N16204/CB497N16208)  
 GWH18ACD-K6DNA2/I  
 GWH18ACDXD-K6DNA3/I  
 GWH18ACDXD-K6DNA4/I(CB344N02902)  
 GWH18ACD-K6DNA5/I(CB341N03302)  
 GWH18ACDXF-K6DNA1A/I  
 GWH18ACDXF-K6DNA3A/I  
 GWH24ACE-K6DNA1/I(CB497N16100/CB497N16102/CB497N16103/CB497N16104/CB497N16108)  
 GWH24ACE-K6DNA2/I  
 GWH24ACE-K6DNA3J/I  
 GWH24ACEXF-K6DNA4/I(CB344N03002)  
 GWH24ACE-K6DNA5/I

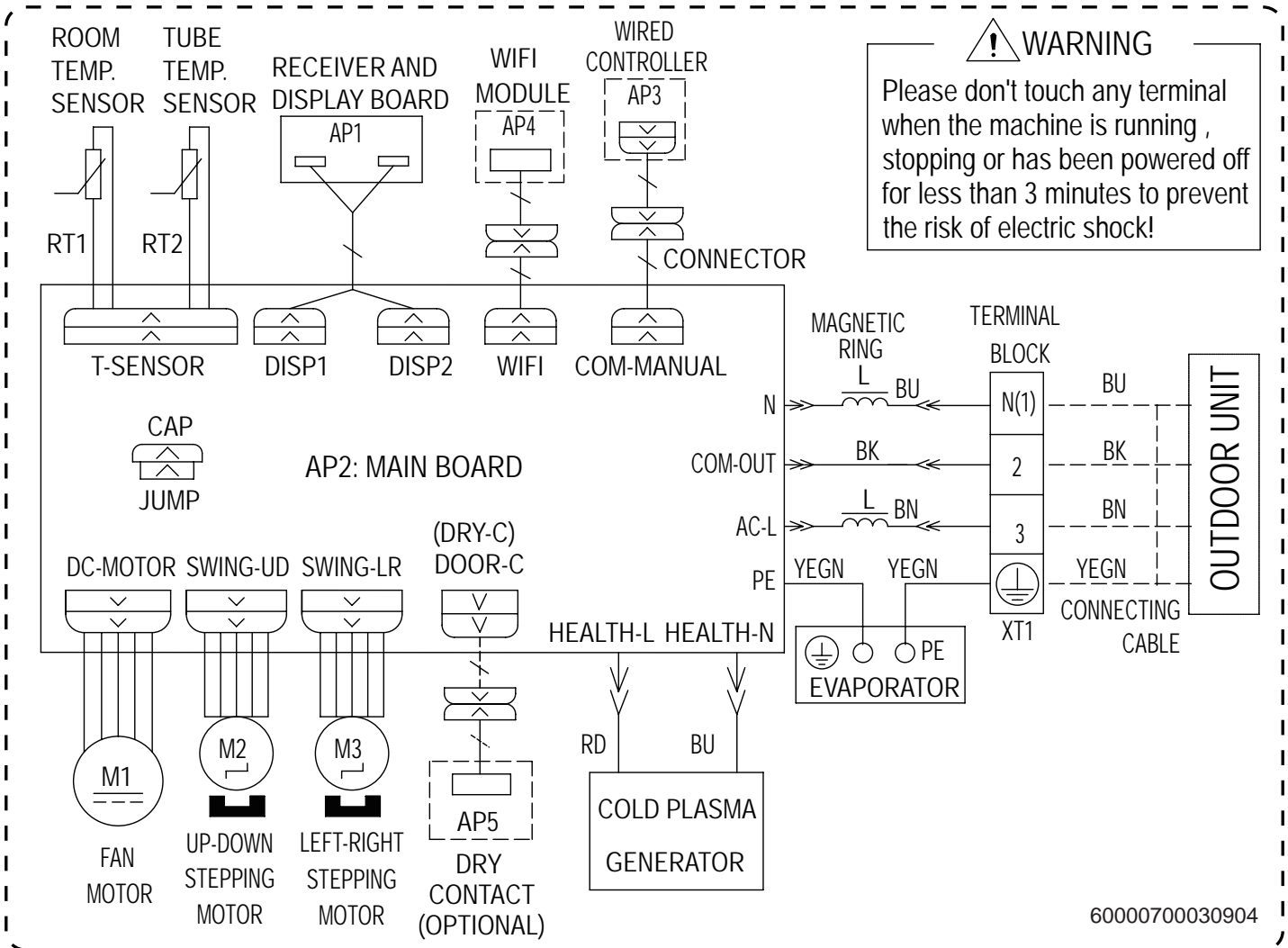

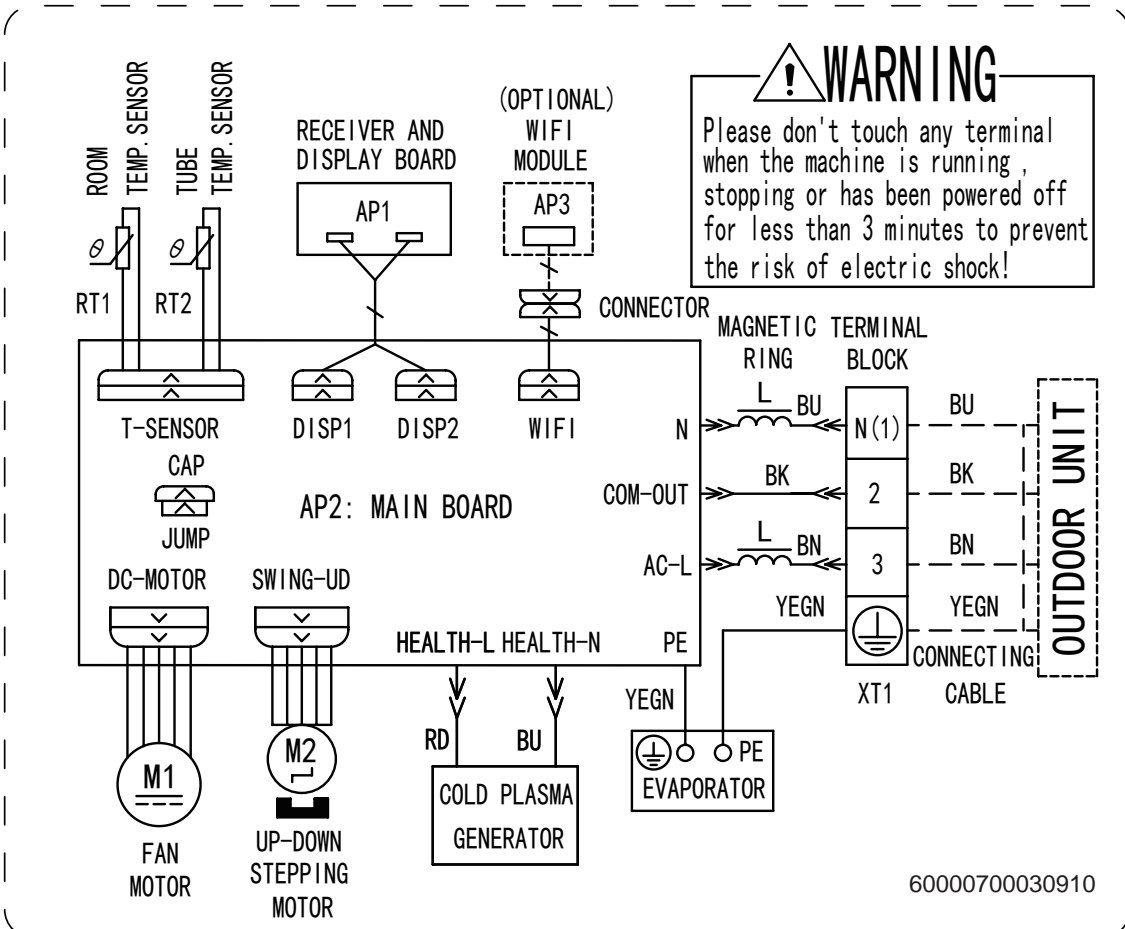
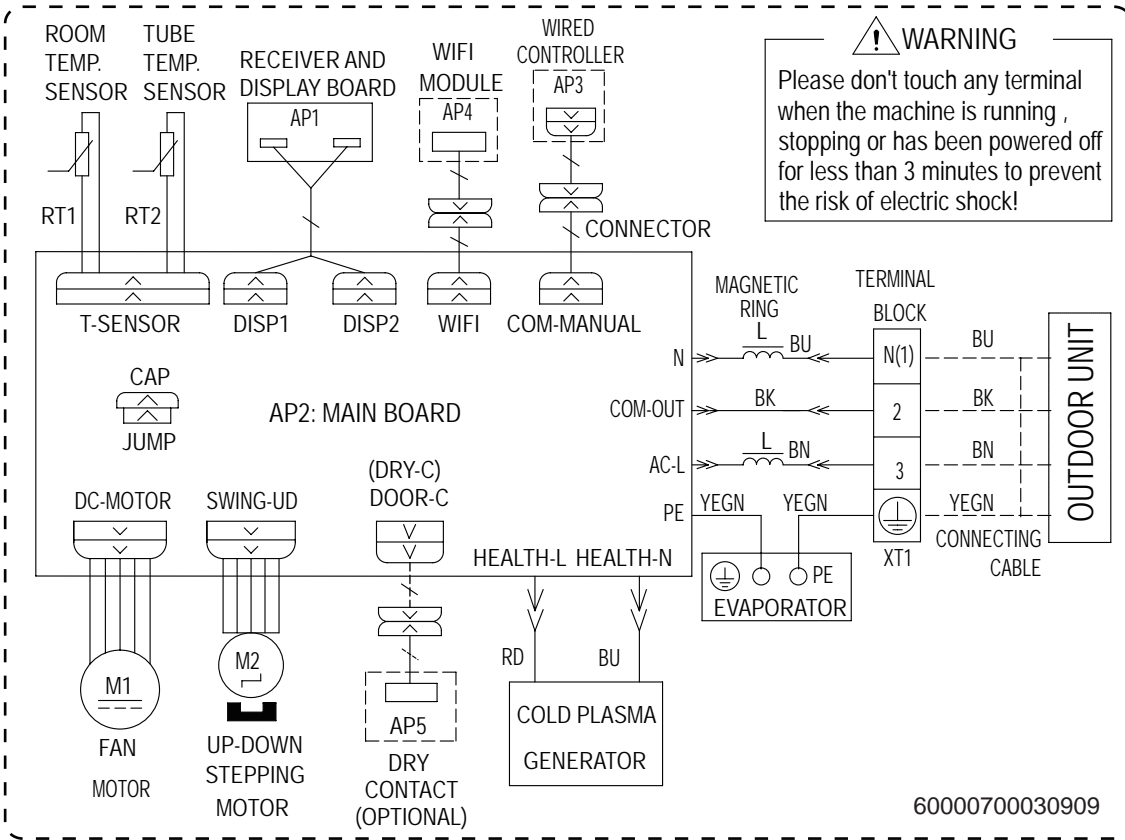

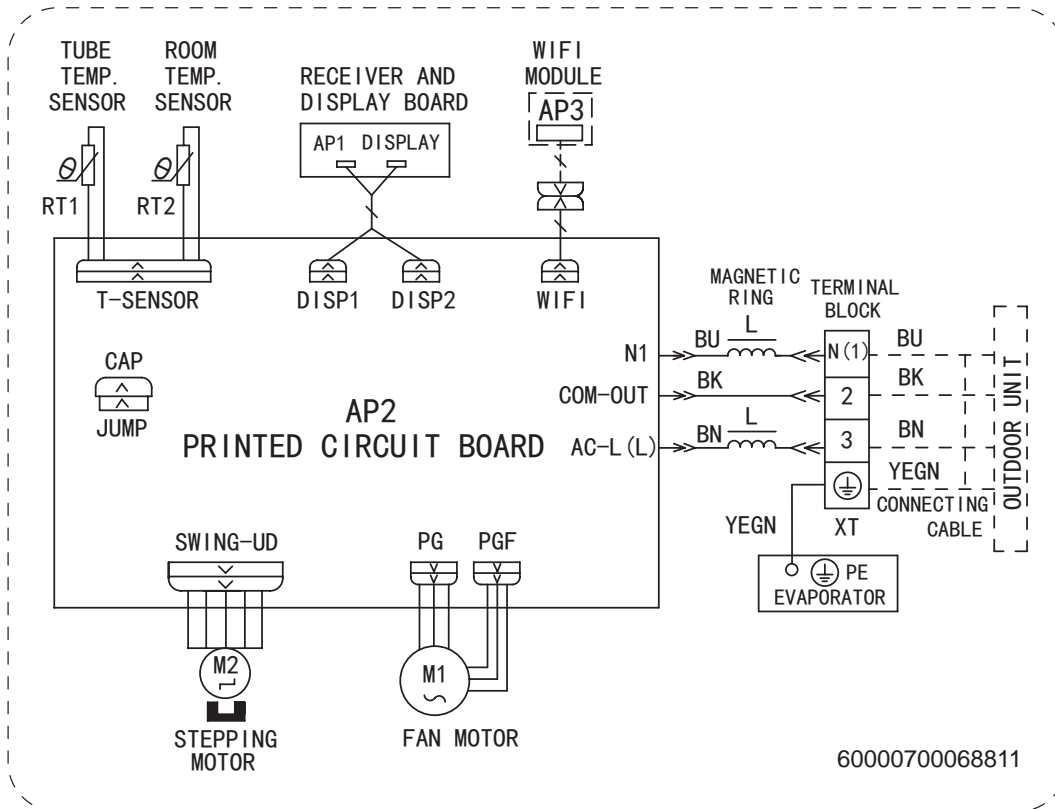
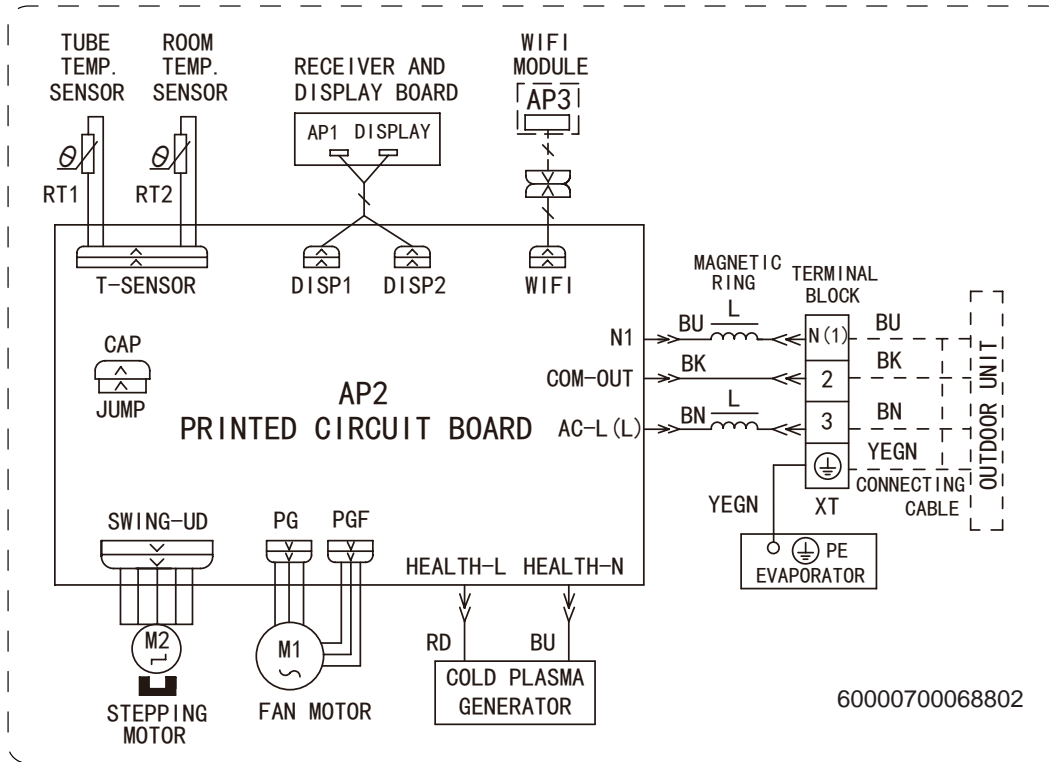



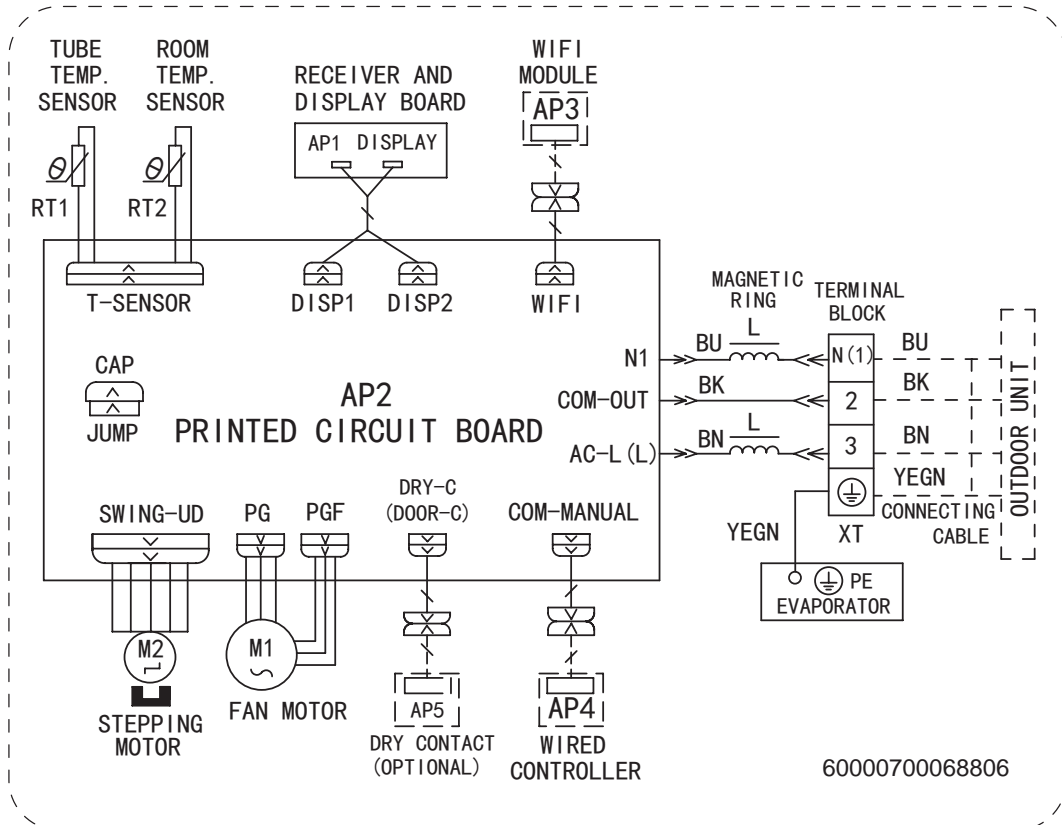
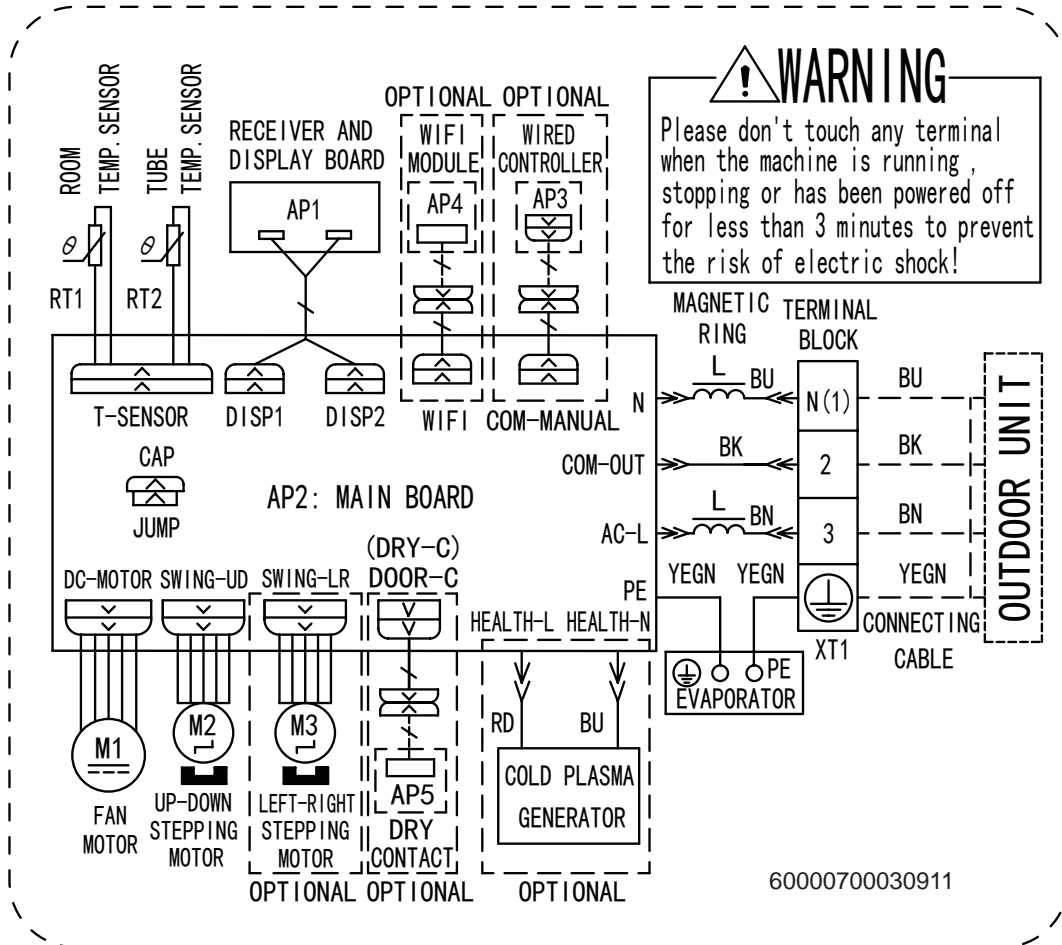

GWH07ACAXA-K6DNA4A/I  
GWH12ACBxB-K6DNA4A/I

GWH09ACAXB-K6DNA4B/I  
GWH12ACB-K6DNA3D/I(CB343N05100)

GWH09ACA-K6DNA3A/I(CB343N05000)

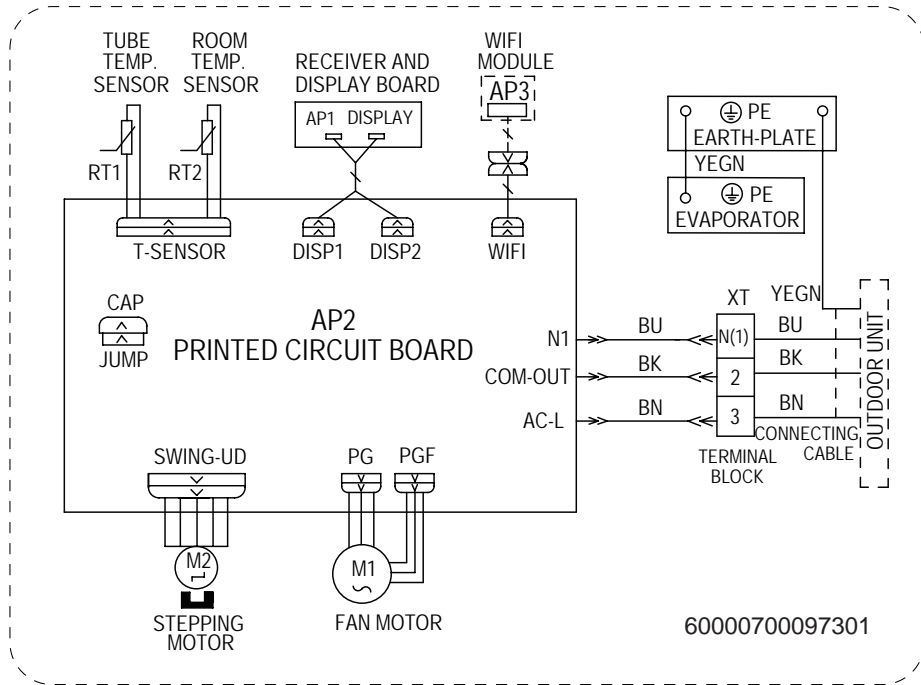

GWH24ACDXE-K6DNA3B/I(CB343N04900) GWH24ACDXE-K6DNA4B/I(CB344N03400)

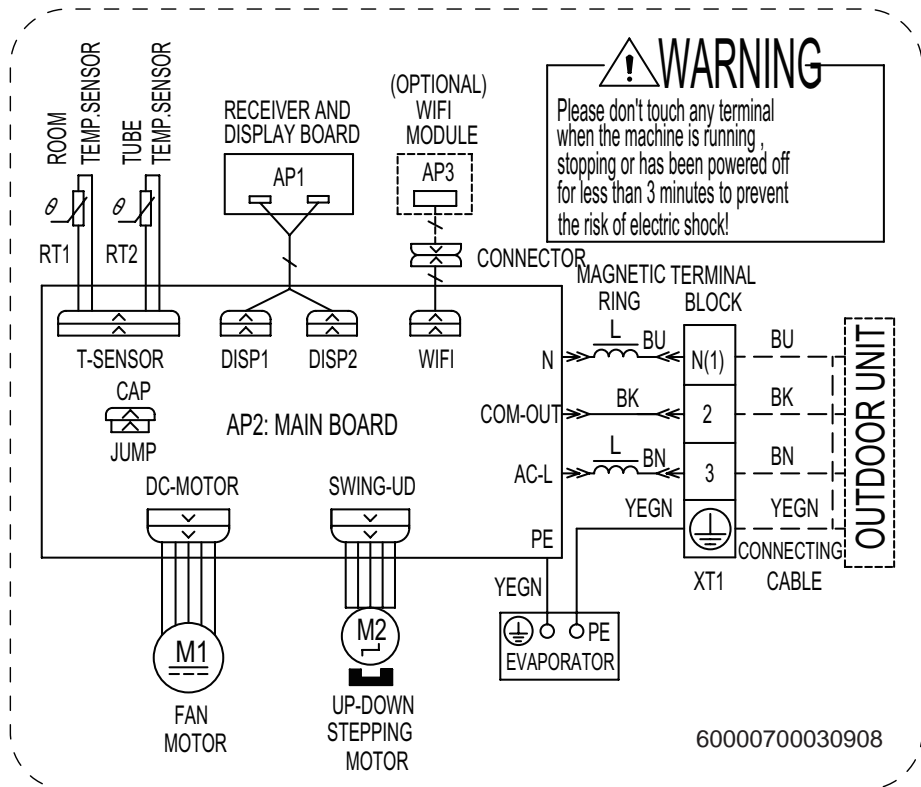



• Outdoor Unit

GWH07AGA-K6DNA1A/O

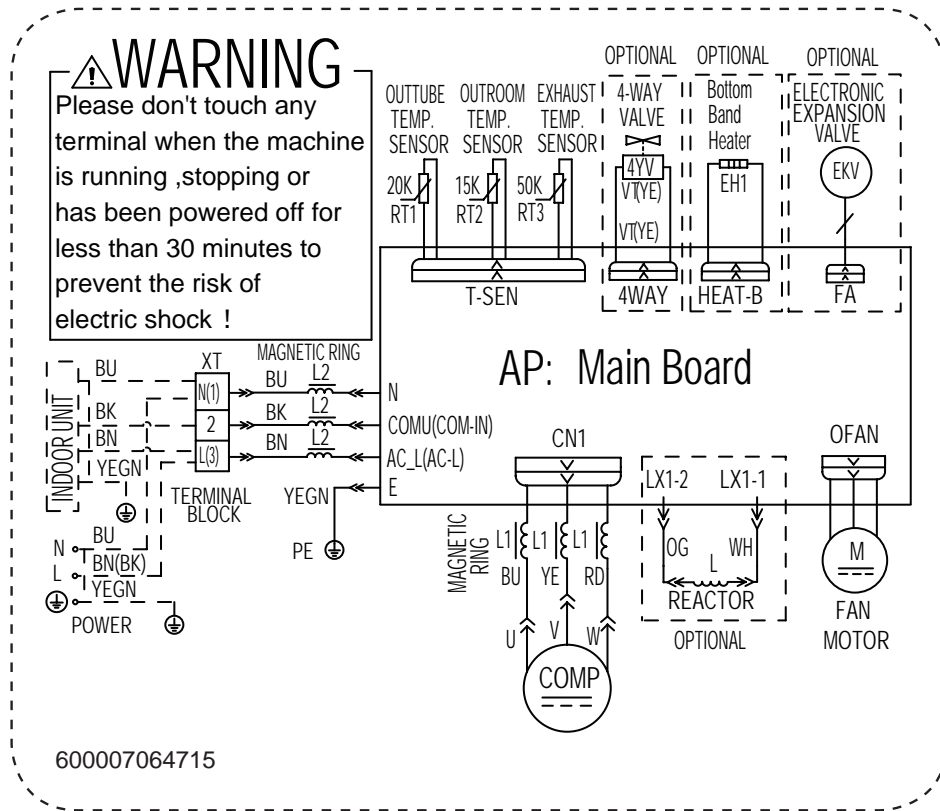

GWH09AFC-K6DNA2F/O GWH12AFC-K6DNA2F/O

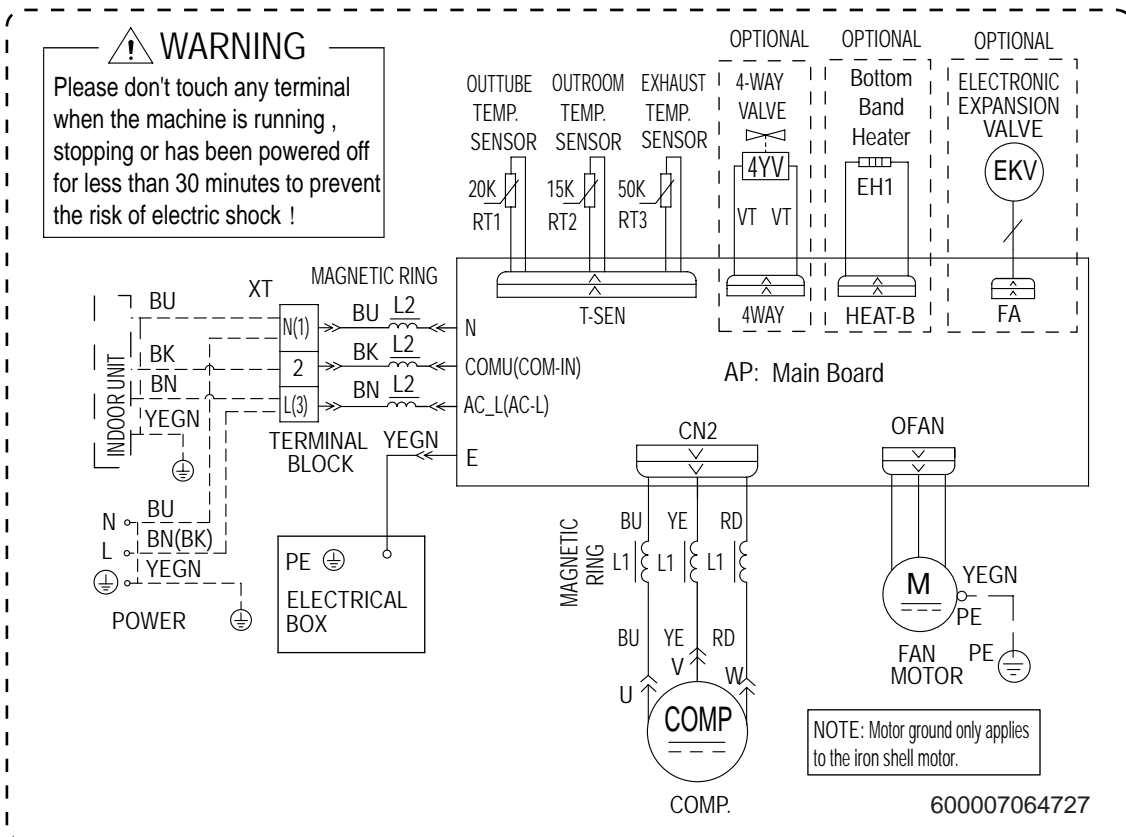

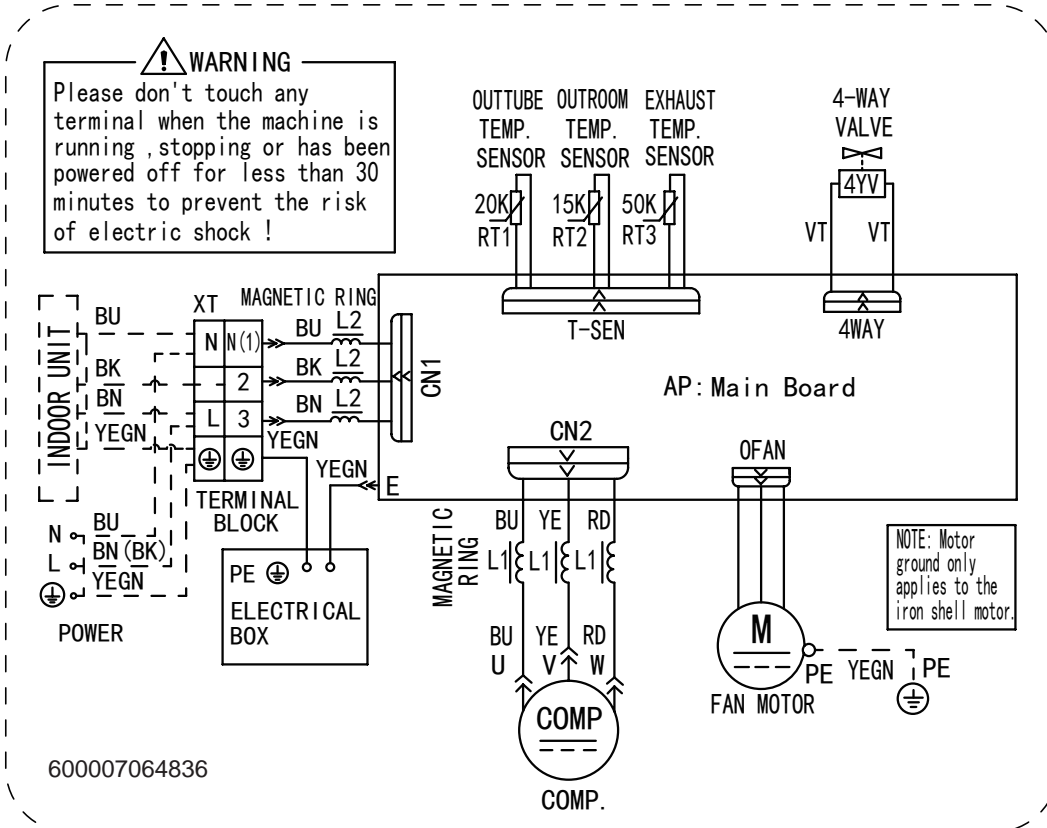
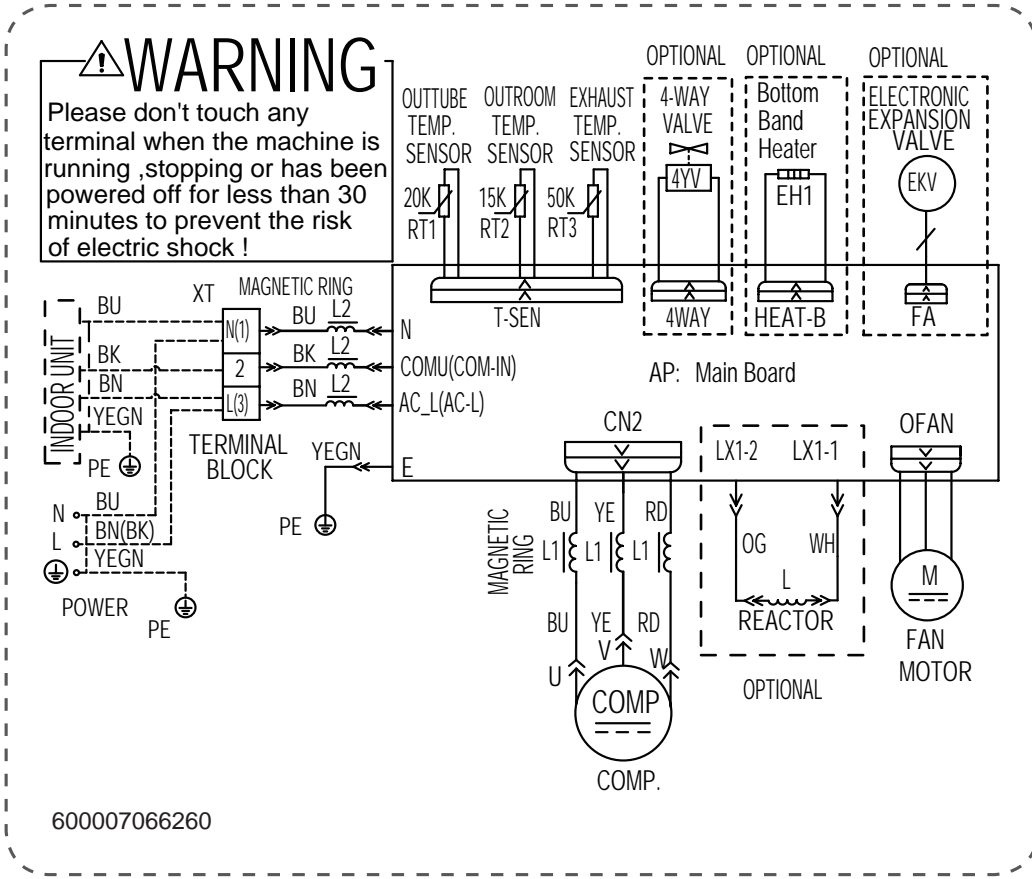

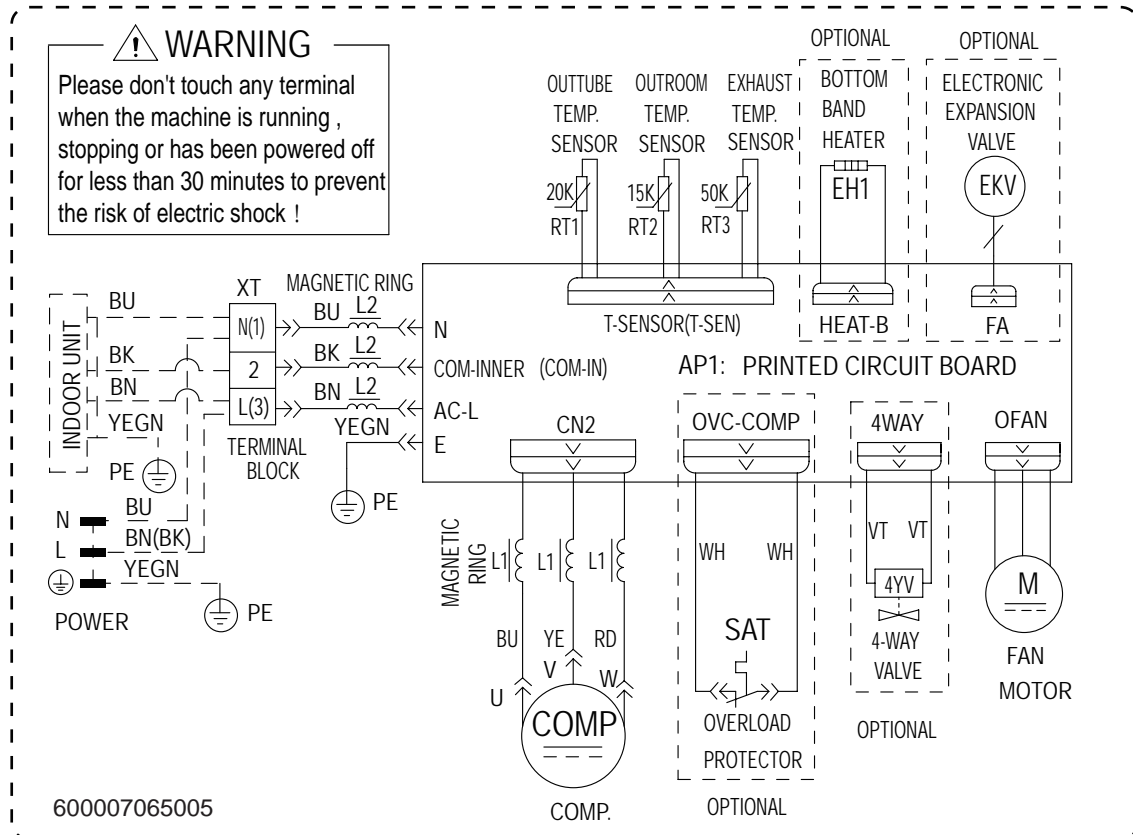

These wiring diagrams are subject to change without notice; please refer to the one supplied with the unit.





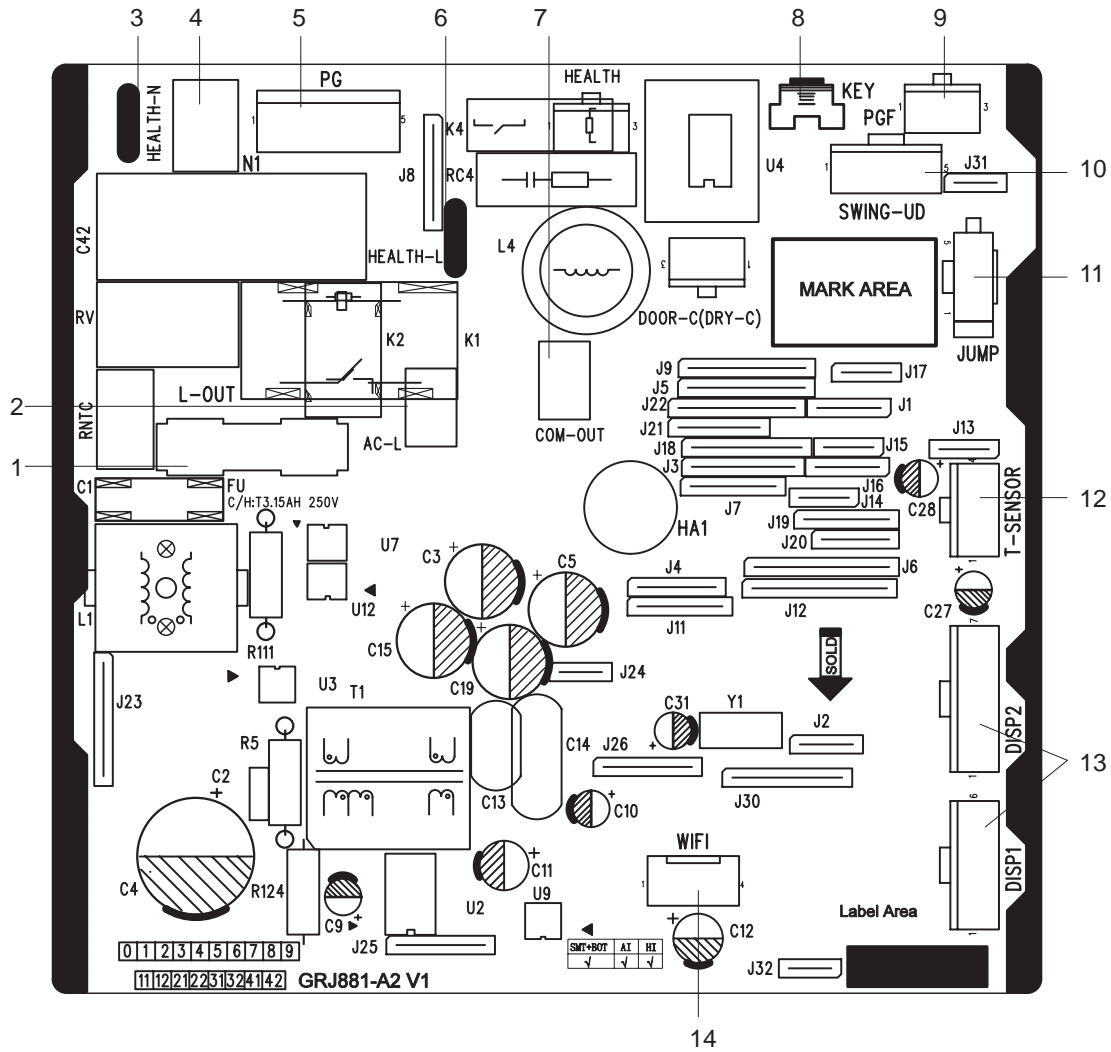

No.	Name
1	Fuse
2	Live wire terminal
3	Terminal of health function neutral wire(only for the model with this function)
4	Neutral wire terminal
5	Fan motor terminal of PG
6	Terminal of health function live wire(only for the model with this function)
7	Communication terminal

No.	Name
8	Auto button
9	Terminal of PG feedback interface
10	Swing terminal
11	Jumper cap
12	Terminal of temperature sensor
13	Interface of display board
14	Wifi terminal



# Outdoor Unit

GWH07AGA-K6DNA1A/O

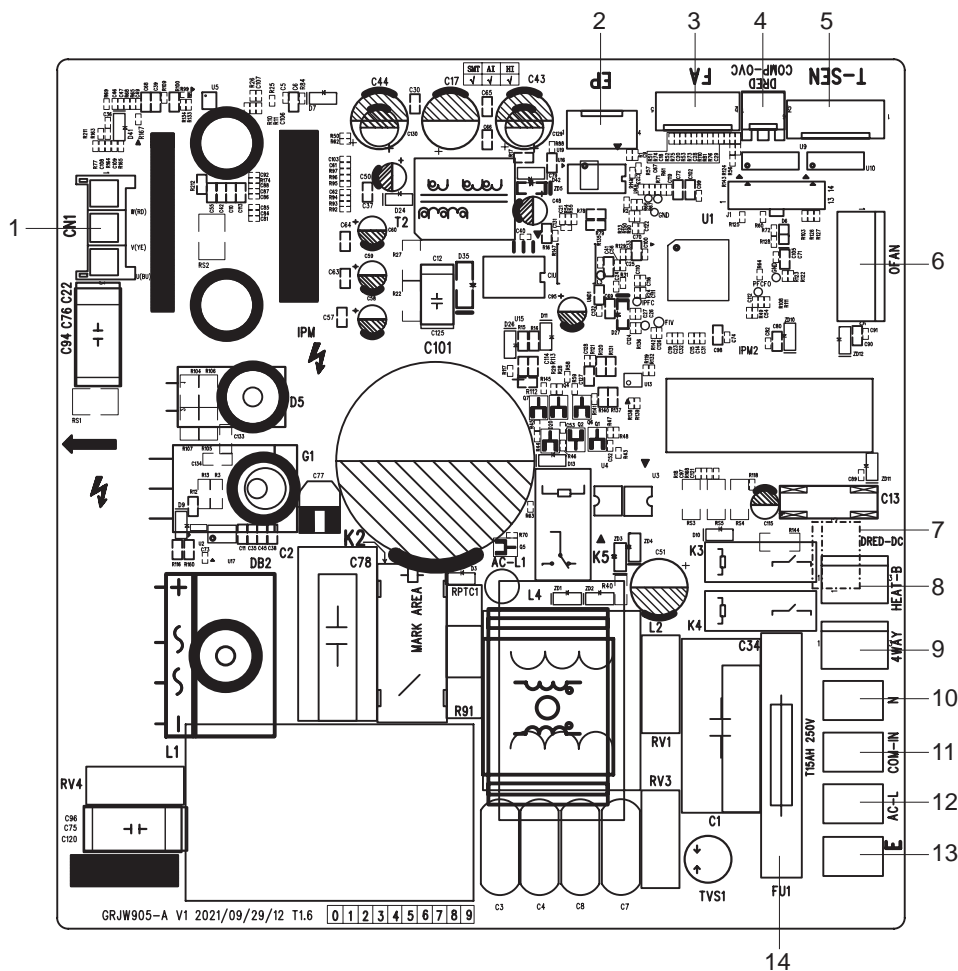

No.	Name	No.	Name
1	Compressor terminal	8	Chassis electric heater terminal
2	EE flash drive terminal	9	4-way valve terminal
3	Electronic expansion valve terminal	10	Neutral wire terminal
4	Compressor overload terminal	11	Communication wire terminal
5	Temperature sensor terminal	12	Live wire terminal
6	Outdoor fan terminal	13	Earthing wire terminal
7	DRED	14	Fuse



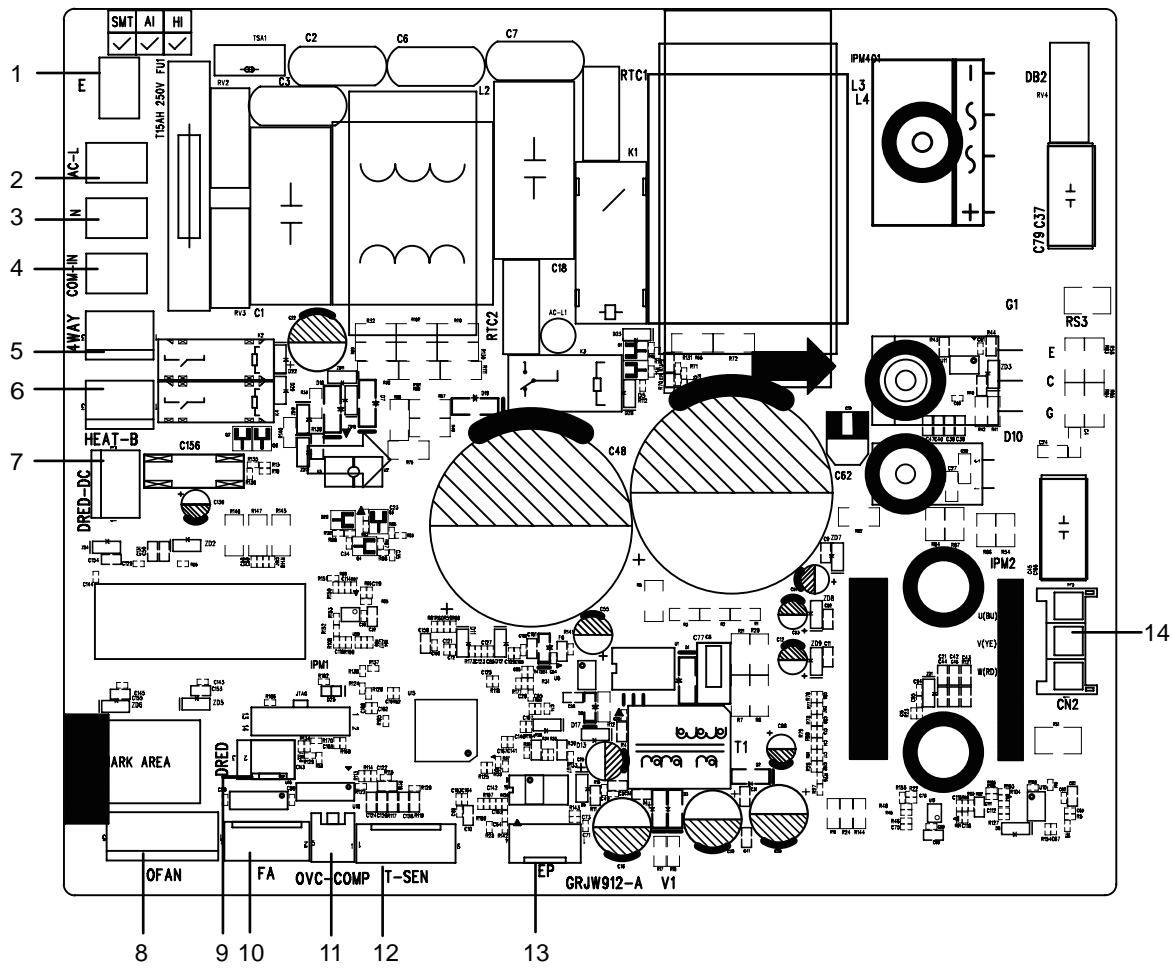

No.	Name	No.	Name
1	Earthing wire	8	Outdoor fan
2	Live wire	9	DRED(Reserved)
3	Neutral wire	10	Electronic expansion valve
4	Communication wire	11	Compressor Overload
5	4-way valve	12	Temperature sensor
6	Electric heating of chassis	13	EE Flash drives
7	DRED-DC(Reserved)	14	Compressor

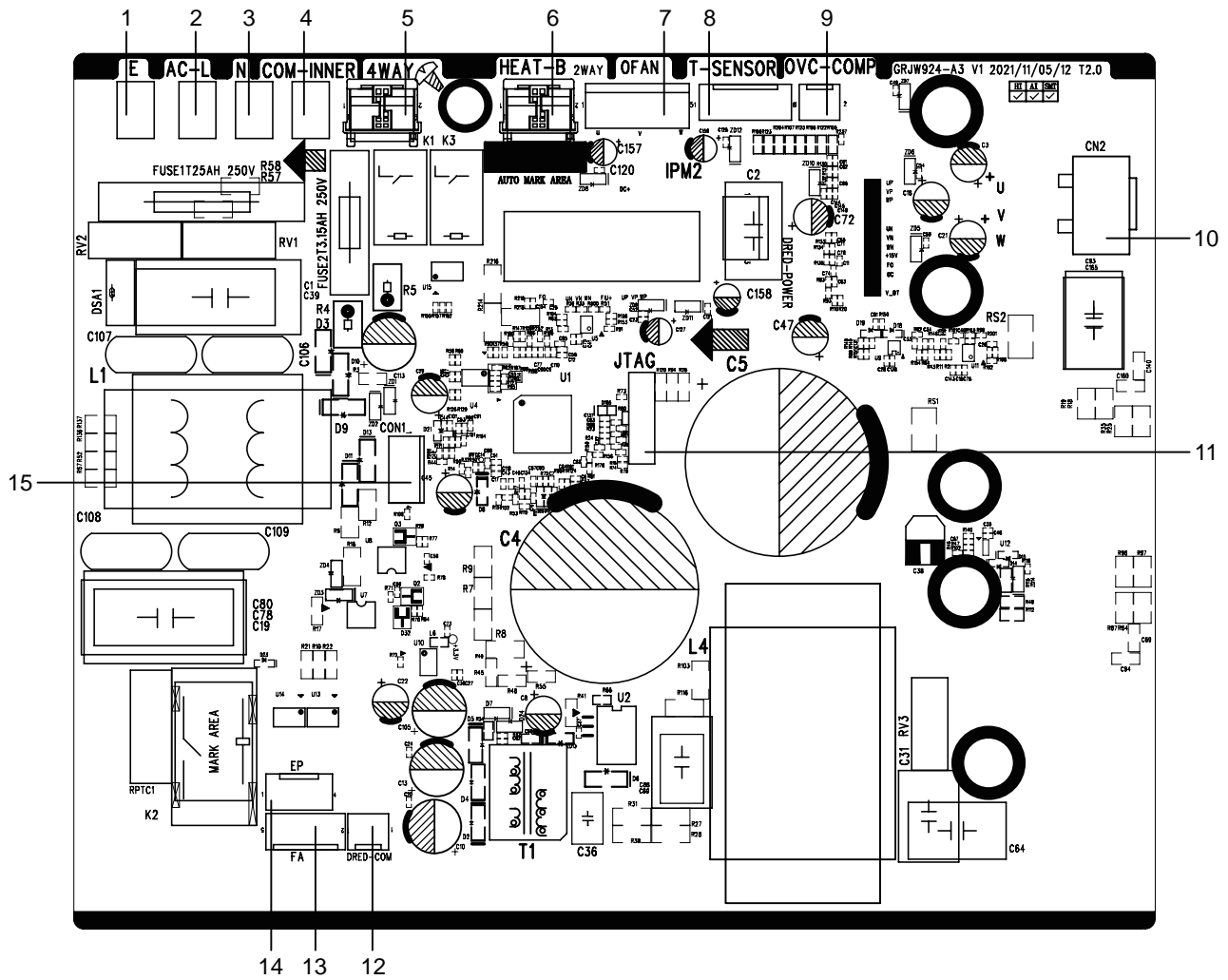

No.	Name	No.	Name
1	Eathing wire	9	Overload interface of compressor
2	Live wire	10	Terminal of compressor
3	Neutral wire	11	Interface of program debugs
4	Communication cable	12	DRED interface
5	4-way valve	13	Terminal of electronic expansion valve
6	Electric heating belt of chassis / 2-way valve	14	EE flash drive
7	DC motor	15	Computer monitoring interface
8	Temperature sensor		

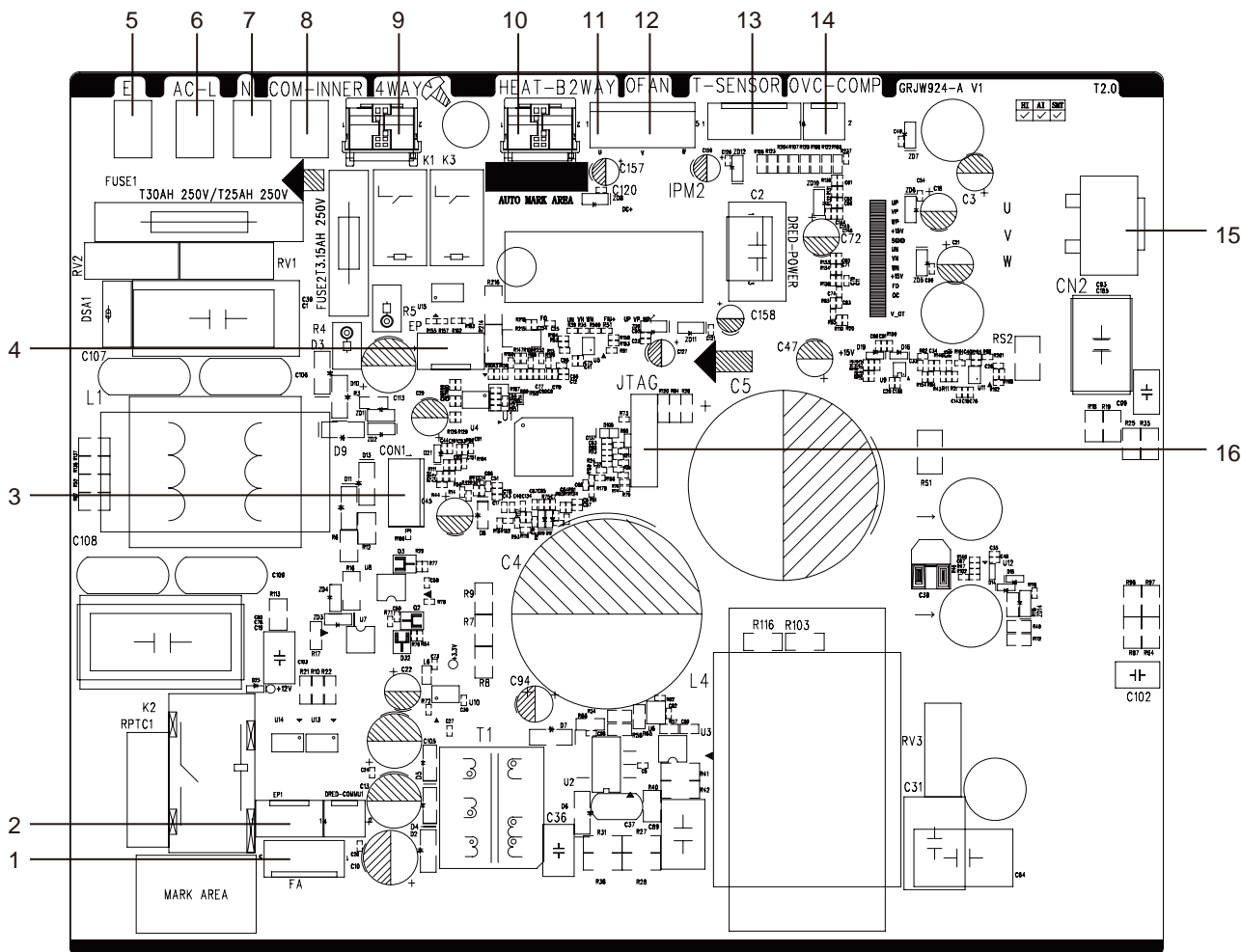

No.	Name	No.	Name
1	Terminal of electronic expansion valve	9	4-way valve
2	E disk(Reserved)	10	Electric heating belt of chassis
3	Computer monitoring interface	11	2-way valve
4	EE flash drive	12	DC motor
5	Grounding wire	13	Temperature sensor
6	Live wire	14	Overload interface of compressor
7	Neutral wire	15	Terminal of compressor
8	Communication wire	16	Interface of program debugs



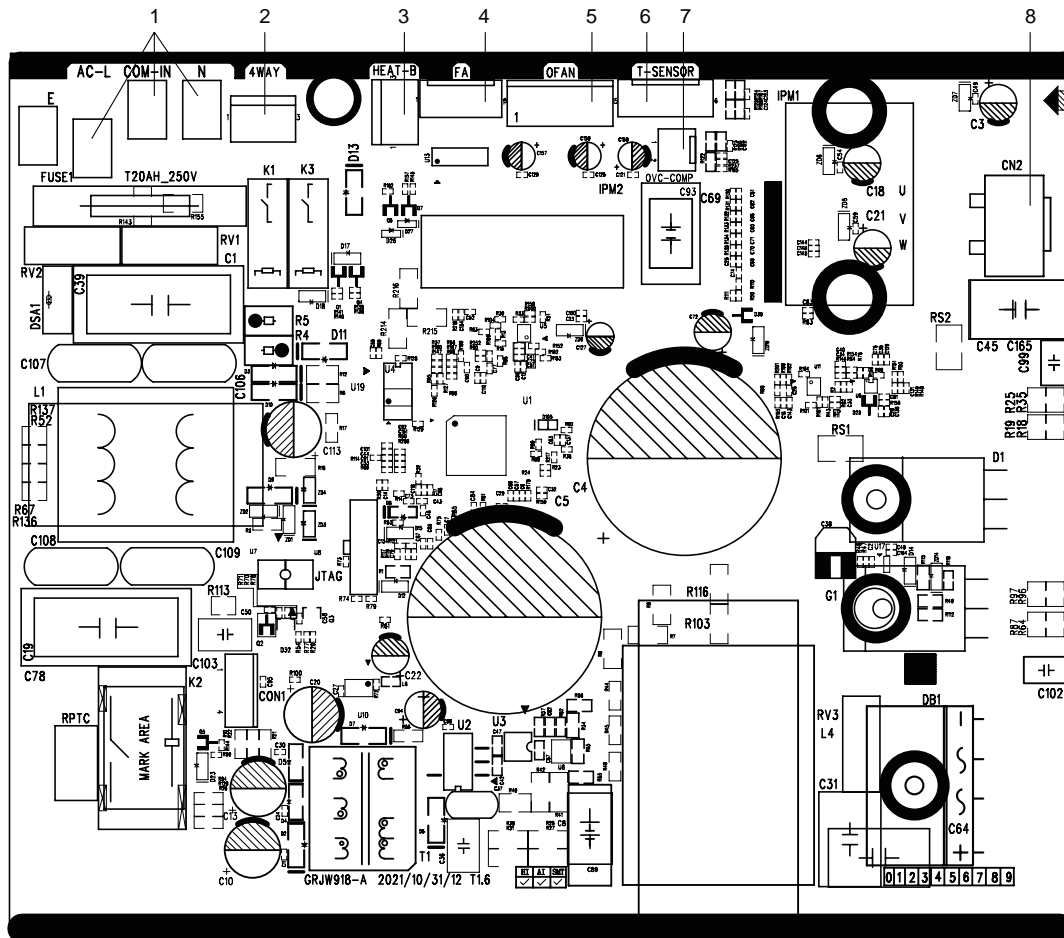

No.	Name
1	Neutral wire, live wire and communication cable
2	4-way valve
3	electric heating belt of chassis
4	Electronic expansion valve
5	Outdoor fan
6	Temperature sensor
7	Overload
8	Three-phase terminal of compressor

# 6. Function and Control

## 6.1 Remote Controller Introduction for YAP1F7(WiFi)

### Buttons on remote controller



### Introduction for buttons on remote controller

#### NOTE:

1. This is a general use remote controller. It could be used for the air conditioner with multifunction. For the functions which the model doesn't have, if press the corresponding button on the remote controller, the unit will keep the original running status.
2. After putting through the power, the air conditioner will give out a sound. Operation indicator "⏻" is ON (red indicator, the colour is different for different models). After that, you can operate the air conditioner by using remote controller.
3. Under on status, pressing the button on the remote controller, the signal icon "📶" on the display of remote controller will blink once and the air conditioner will give out a "di" sound, which means the signal has been sent to the air conditioner.
4. As for the models with functions of WiFi or wired controller, the indoor unit must has been controlled by standard remote controller under auto mode first, and then the function of adjustable temperature under auto mode can be realized by APP or the wired controller.
5. This remote controller can adjust the temperature under auto mode. When matching with the unit which is without the function of adjustable temperature under auto mode, the set temperature under auto mode may be invalid, or the displayed set temperature on the unit is not same as that on the remote controller under auto mode.

### Introduction for icons on display screen

	I feel	
	Set fan speed	
	Turbo mode	
	Send signal	
Operation mode		Auto mode
		Cool mode
		Dry mode
		Fan mode
		Heat mode
		Sleep mode
	8°C heating function	
	Power limiting operation	
	Health mode	
	Scavenging function	
	X-FAN function	
Temp. display type		Set temp.
		Indoor ambient temp.
		Outdoor ambient temp.
	Clock	
	Set temperature	
	WiFi function	
	Set time	
	TIMER ON / TIMER OFF	
	Left & right swing	
	Up & down swing	
	Child lock	
	Quiet	

#### ON/OFF button



Press this button to turn on the unit. Press this button again to turn off the unit.





#### MODE button





Press this button to select your required operation mode :



- When selecting auto mode, air conditioner will operate automatically according to the ex-factory setting. Press "FAN" button can adjust fan speed. Press "🌀" / "🌀" button can adjust fan blowing angle.
- After selecting cool mode, air conditioner will operate under cool mode. Press "△" or "▽" button to adjust set temperature. Press "FAN" button to adjust fan speed. Press "🌀" / "🌀" button to adjust fan blowing angle.
- When selecting dry mode, the air conditioner operates at low speed under dry mode. Under dry mode, fan speed can't be adjusted. Press "🌀" / "🌀" button to adjust fan blowing angle.

- When selecting fan mode, the air conditioner will only blow fan, no cooling and no heating. Press "FAN" button to adjust fan speed. Press "  " / "  " button to adjust fan blowing angle.

When selecting heat mode, the air conditioner operates under heat mode. Press "  " or "  " button to adjust set temperature. Press "FAN" button to adjust fan speed. Press "  " / "  " button to adjust fan blowing angle.

- When selecting heating mode, the air conditioner operates under heat mode. Press "  " or "  " button to adjust set temperature. Press "FAN" button to adjust fan speed. Press "  " / "  " button to adjust fan blowing angle. (Cooling only unit won't receive heating mode signal. If setting heat mode with remote controller, press ON/OFF button can't start up the unit).

#### NOTE:

- For preventing cold air, after starting up heat mode, indoor unit will delay 1~5 minutes to blow air (Actual delay time depends on indoor ambient temperature).
- Set temperature range from remote controller: 16~30°C (61~86°F).
- Under auto mode, temperature can be displayed; Under auto mode, set temperature can be adjusted.
- This mode indicator is not available for some models.



### FAN button

This button is used for setting Fan Speed in the sequence that goes from AUTO,  ,  ,  ,  ,  ,  , then back to Auto.







#### NOTE:

- Under AUTO speed, air conditioner will select proper fan speed automatically according to factory default setting.
- It's low fan speed under dry mode.
- X-FAN function Hold fan speed button for 2s in cool or dry mode, the icon "  " is displayed and the indoor fan will continue operation for a few minutes in order to dry the indoor unit even though you have turned off the unit. After energization, X-FAN OFF is defaulted. X-FAN is not available in auto, fan or heat mode.
- This function indicates that moisture on evaporator of indoor unit will be blown after the unit is stopped to avoid mould.
- Having set X-FAN function on: After turning off the unit by pressing " ON/OFF " button indoor fan will continue running for a few minutes. at low speed. In this period, Hold fan speed button for 2s to stop indoor fan directly.
- Having set X-FAN function off: After turning off the unit by pressing " ON/OFF " button, the complete unit will be off directly.

### TURBO button

Under COOL or HEAT mode, press this button to turn to quick COOL or quick HEAT mode. "  " icon is displayed on remote controller. Press this button again to exit turbo function and "  " icon will disappear. If start this function, the unit will run at super-high fan speed to cool or heat quickly so that the ambient temperature approaches the preset temperature as soon as possible.

### / button



- Press "  " or "  " button once increase or decrease set temperature 1°C (°F). Holding "  " or "  " button, 2s later, set temperature on remote controller will change quickly. On releasing button after setting is finished, temperature indicator on indoor unit will change accordingly.
- When setting T-ON, T-OFF or CLOCK, press "  " or "  " button to adjust time. (Refer to CLOCK, T-ON, T-OFF buttons)

### button

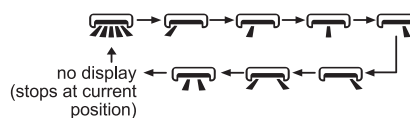
Press this button can select left & right swing angle. Fan blow angle can be selected circularly as below:







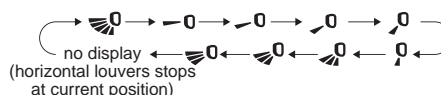

#### NOTE:

- Press this button continuously more than 2s, the main unit will swing back and forth from left to right, and then loosen the button, the unit will stop swinging and present position of guide louver will be kept immediately.
- Under left and right swing mode, when the status is switched from off to  , if press this button again 2s later,  status will switch to off status directly; if press this button again within 2s, the change of swing status will also depend on the circulation sequence stated above.
- This function is only available for some models.

### button

Press this button can select left & right swing angle. Fan blow angle can be selected circularly as below:



- When selecting "  ", air conditioner is blowing fan automatically. Horizontal louver will automatically swing up & down at maximum angle.
- When selecting "  ,  ,  ,  ,  ", air conditioner is blowing fan at fixed position. Horizontal louver will stop at the fixed

position.

- When selecting " , , " , air conditioner is blowing fan at fixed angle. Horizontal louver will send air at the fixed angle.
- Hold " " button above 2s to set your required swing angle. When reaching your required angle, release the button.

#### NOTE:

- " , , " may not be available. When air conditioner receives this signal, the air conditioner will blow fan automatically.
- Press this button continuously for more than 2s, the main unit will swing back and forth from up to down, and then loosen the button, the unit present position of guide louver will be kept immediately.
- Under up and down swing mode, when the status is switched from off to , if press this button again 2s later, status will switch to off status directly; if press this button again within 2s, the change of swing status will also depend on the circulation sequence stated above.

#### T-ON|T-OFF button

- T-ON button

"T-ON" button can set the time for timer on. After pressing this button, " " icon disappears and the word "ON" on remote controller blinks. Press " " or " " button to adjust T-ON setting. After each pressing " " or " " button, T-ON setting will increase or decrease 1min. Hold " " or " " button, 2s later, the time will change quickly until reaching your required time. Press "T-ON" to confirm it. The word "ON" will stop blinking. " " icon resumes displaying. Cancel T-ON: Under the condition that T-ON is started up, press "T-ON" button to cancel it.

- T-OFF button

"T-OFF" button can set the time for timer off. After pressing this button, " " icon disappears and the word "OFF" on remote controller blinks. Press " " or " " button to adjust T-OFF setting. After each pressing " " or " " button, T-OFF setting will increase or decrease 1min. Hold " " or " " button, 2s later, the time will change quickly until reaching your required time. Press "T-OFF" word "OFF" will stop blinking. " " icon resumes displaying. Cancel T-OFF. Under the condition that T-OFF is started up, press "T-OFF" button to cancel it.

#### NOTE:

- Under on and off status, you can set T-OFF or T-ON simultaneously.
- Before setting T-ON or T-OFF, please adjust the clock time.
- After starting up T-ON or T-OFF, set the constant circulating valid.

- After that, air conditioner will be turned on or turned off according to setting time. ON/OFF button has no effect on setting. If you don't need this function, please use remote controller to cancel it.

#### I FEEL button

Press this button to start I FEEL function and " " will be displayed on the remote controller. After this function is set, the remote controller will send the detected ambient temperature to the controller and the unit will automatically adjust the indoor temperature according to the detected temperature. Press this button again to cancel I FEEL function and " " will disappear.

- Please put the remote controller near user when this function is set. Do not put the remote controller near the object of high temperature or low temperature in order to avoid detecting inaccurate ambient temperature. When I FEEL function is turned on, the remote controller should be put within the area where indoor unit can receive the signal sent by the remote controller.

#### CLOCK button

Press this button to set clock time. " " icon on remote controller will blink. Press " " or " " button within 5s to set clock time. Each pressing of " " or " " button, clock time will increase or decrease 1 minute. If hold " " or " " button, 2s later, time will change quickly. Release this button when reaching your required time. Press "CLOCK" button to confirm the time. " " icon stops blinking.

#### NOTE:

- Clock time adopts 24-hour mode.
- The interval between two operations can't exceed 5s. Otherwise, remote controller will quit setting status. Operation for TIMER ON/TIMER OFF is the same.

#### SLEEP button

- Press this button, can select Sleep 1 ( 1 ), Sleep 2 ( 2 ), Sleep 3 ( 3 ) and cancel the Sleep, circulate between these, after electrified, Sleep Cancel is defaulted.
- Sleep 1 is Sleep mode 1, in Cool modes; sleep status after run for one hour, the main unit setting temperature will increase 1 , two hours, setting temperature increased 2°C, then the unit will run at this setting temperature; In Heat mode: sleep status after run for one hour, the setting temperature will decrease 1 , two hours, setting temperature will decrease 2 , then the unit will run at this setting temperature.
- Sleep 2 is sleep mode 2, that is air conditioner will run according to the presetting a group of sleep temperature curve.
- Sleep 3- the sleep curve setting under Sleep mode by DIY;

(1) Under Sleep 3 mode, press "Turbo" button for a long time, remote controller enters into user individuation sleep setting status, at this time, the time of remote controller will display "1hour", the setting temperature "88" will display the corresponding temperature of last setting sleep curve and blink (The first entering will display according to the initial curve setting value of original factory);

(2) Adjust "△" and "▽" button, could change the corresponding setting temperature, after adjusted, press "Turbo" button for confirmation;

(3) At this time, 1hour will be automatically increased at the timer position on the remote control, (that are "2hours" or "3hours" or "8hours"), the place of setting temperature "88" will display the corresponding temperature of last setting sleep curve and blink;

(4) Repeat the above step (2)~(3) operation, until 8 hours temperature setting finished, sleep, curve setting finished, at this time, the remote controller will resume the original timer display; temperature display will resume to original setting temperature.

- Sleep3- the sleep curve setting under Sleep mode by DIY could be inquired:

The user could accord to sleep curve setting method to inquire the presetting sleep curve, enter into user individuation sleep setting status, but do not change the temperature, press "Turbo" button directly for confirmation.

NOTE: In the above presetting or enquiry procedure, if continuously within 10s, there is no button pressed, the sleep curve setting within 10s, there is no button pressed, the sleep curve setting status will be automatically quit and resume to display the original displaying. In the presetting or enquiry procedure, press "ON/OFF" button, "MODE" button, "SLEEP" button, the sleep curve setting or enquiry status will quit similarly.

#### WiFi button

Press "WiFi" button to turn on WiFi function, "WiFi" icon will be displayed on the remote controller; Hold "WiFi" button for 5s to turn off WiFi function and "WiFi" icon will disappear.

Under off status, press "MODE" and "WiFi" buttons simultaneously for 1s, WiFi module will restore factory settings.

- This function is only available for some models.

#### 🏠/🏡 button

Press this button to achieve the on and off of health and scavenging functions in operation station. Press this button for the first time to start scavenging function; LCD displays "🏠". Press the button for the second time to start health and scavenging functions simultaneously; LCD displays "🏠" and "🏡". Press this button for the third time to quit health and scavenging functions simultaneously. Press the button for the fourth time to start health

function; LCD display "🏡". Press this button again to repeat the operation above.

- This function is applicable to partial of models.

#### LIGHT button

Press this button to turn off display light on indoor unit. "💡" icon on remote controller disappears. Press this button again to turn on display light. "💡" icon is displayed.

#### TEMP button

Press this button, you can see indoor set temperature, indoor ambient temperature on indoor unit's display. The setting on remote controller is selected circularly as below:



### Function introduction for combination buttons

#### Energy-saving function

Under cooling mode, press "TEMP" and "CLOCK" buttons simultaneously to start up or turn off energysaving function. When energy-saving function is started up, "SE" will be shown on remote controller, and air conditioner will adjust the set temperature automatically according to ex-factory setting to reach to the best energy-saving effect. Press "TEMP" and "CLOCK" buttons simultaneously again to exit energysaving function.

#### NOTE:

- Under energy-saving function, fan speed is defaulted at auto speed and it can't be adjusted.
- Under energy-saving function, set temperature can't be adjusted. Press "TURBO" button and the remote controller won't send signal.
- Sleep function and energy-saving function can't operate at the same time. If energy-saving function has been set under cool mode, press sleep button will cancel energy-saving function. If sleep function has been set under cool mode, start up the energy-saving function will cancel sleep function.

#### 8°C heating function

Under heat mode, press "TEMP" and "CLOCK" buttons simultaneously to start up or turn off 8°C heating function. When this function is started up, "8°C" and "🌡️" will be shown on remote controller, and the air conditioner keep the heating status at 8°C.

Press "TEMP" and "CLOCK" buttons simultaneously again to exit 8°C heating function.

#### NOTE:

- Under 8°C heating function, fan speed is defaulted at auto speed and it can't be adjusted.



- Under 8°C heating function, set temperature can't be adjusted.

Press "TURBO" button and the remote controller won't send signal.

- Sleep function and 8°C heating function can't operate at the same time. If 8°C heating function has been set under heat mode, press sleep button will cancel 8°C heating function. If sleep function has been set under heat mode, start up the 8°C heating function will cancel sleep function.

- Under °F temperature display, the remote controller will display 46°F heating.

### Child lock function

Press "△" and "▽" simultaneously to turn on or turn off child lock function. When child lock function is on, "🔒" icon is displayed on remote controller. If you operate the remote controller, the "🔒" icon will blink three times without sending signal to the unit.

### Temperature display switchover function

Under OFF status, press "▽" and "MODE" buttons simultaneously to switch temperature display between °C and °F.

### Auto clean function

Under unit off status, hold "MODE" and "FAN" buttons simultaneously for 5s to turn on or turn off the auto clean function. When the auto clean function is turned on, indoor unit displays "CL". During the auto clean process of evaporator, the unit will perform fast cooling or fast heating. There may be some noise, which is the sound of flowing liquid or thermal expansion or cold shrinkage. The air conditioner may blow cool or warm air, which is a normal phenomenon. During cleaning process, please make sure the room is well ventilated to avoid affecting the comfort.

### NOTE:

- The auto clean function can only work under normal ambient temperature. If the room is dusty, clean it once a month; if not, clean it once every three months. After the auto clean function is turned on, you can leave the room. When auto clean is finished, the air conditioner will enter standby status.
- This function is only available for some models.

### 🔒 function

Press "MODE" and "SLEEP" buttons simultaneously to start 🔒 function.

🔒 function is for limiting power of the whole unit. Press this button, the remote controller will circularly display as the following:

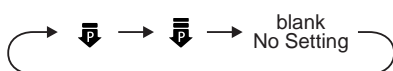

- Maximum power limited under the 🔒 mode is lower than that of mode.

- If you want to cancel the power limiting function, press the 🔒 button till the icon in remote controller is not displayed.

- When the remote controller is turned off, power limiting function is cancelled. If you want to activate the function, please repress this button.

- If the current power is lower than the maximum power of 🔒 mode, then the power will not be limited after entering into such mode.

- For the model with one outdoor unit and two indoor units, if any one of indoor units enters into power limiting function, the outdoor unit will enter into the set limiting power mode of indoor unit; when two indoor units enter into power limiting mode, then the power of outdoor unit will be limited according to the lower power of the two indoor units.

### NOTE:

- This function is only available for some models.

## Replacement of batteries in remote controller

1. Lift the cover along the direction of arrow (as shown in Fig 1 ①).
2. Take out the original batteries (as shown in Fig 1 ②).
3. Place two 7# (AAA 1.5V) dry batteries, and make sure the position of "+" polar and "-" polar is correct (as shown in Fig 2 ③).
4. Reinstall the cover (as shown in Fig 2 ④).

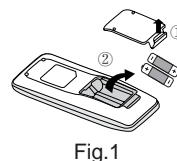

Fig.1

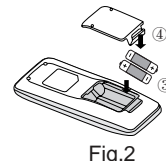

Fig.2

### NOTICE:

- During operation, point the remote control signal sender at the receiving window on indoor unit.
- The distance between signal sender and receiving window should be no more than 8m, and there should be no obstacles between them.
- Signal may be interfered easily in the room where there is fluorescent lamp or wireless telephone; remote controller should be close to indoor unit during operation.
- Replace new batteries of the same model when replacement is required.
- When you don't use remote controller for a long time, please take out the batteries.
- If the display on remote controller is fuzzy or there's no display, please replace batteries.

## 6.2 Remote Controller Introduction for YAC1FB9(WiFi)

### Buttons on remote controller



### Introduction for icons on display screen

	I feel	
	Set fan speed	
	Turbo mode	
Operation mode		Send signal
		Auto mode
		Cool mode
		Dry mode
		Fan mode
		Heat mode
		Sleep mode
	8°C heating function	
	Health mode	
	Scavenging function	
	Quiet	
	X-FAN function	
Temp. display type		Set temp.
		Indoor ambient temp.
		Outdoor ambient temp.
	Clock	
	Set temperature	
	WiFi function	
	Set time	
	TIMER ON / TIMER OFF	
	Light	
	Left & right swing	
	Up & down swing	
	Child lock	

### Introduction for buttons on remote controller

Note:

- This is a general use remote controller. It could be used for the air conditioner with multifunction. For the functions which the model doesn't have, if press the corresponding button on the remote controller, the unit will keep the original running status.
- After putting through the power, the air conditioner will give out a sound. Power indicator "⏻" is ON. After that, you can operate the air conditioner by using remote controller.
- Under on status, pressing the button on the remote controller, the signal icon "📶" on the display of remote controller will blink once and the air conditioner will give out a "di" sound, which means the signal has been sent to the air conditioner.
- As for the models with functions of WiFi or wired controller, the indoor unit must have been controlled by standard remote controller under auto mode first, and then the function of adjustable temperature under auto mode can be realized by APP or the wired controller.
- This remote controller can adjust the temperature under auto mode. When matching with the unit which is without the function of adjustable temperature under auto mode, the set temperature under auto mode may be invalid, or the displayed set temperature on the unit is not same as that on the remote controller under auto mode.

button



Press this button to turn on the unit. Press this button again to turn off the unit.



button

Press this button to select your required operation mode.



- When selecting auto mode, air conditioner will operate automatically according to the sensed temperature. Press "FAN" button can adjust fan speed. Press "🌀" / "🌀" button can adjust fan blowing angle.
- After selecting cool mode, air conditioner will operate under cool mode. Press "▲" or "▼" button to adjust set temperature. Press "FAN" button to adjust fan speed. Press "🌀" / "🌀" button to adjust fan blowing angle.
- When selecting dry mode, the air conditioner operates at low speed under dry mode. Under dry mode, fan speed can't be adjusted. Press "🌀" / "🌀" button to adjust fan blowing angle.





- When selecting fan mode, the air conditioner will only blow fan, no cooling and no heating. Press "FAN" button to adjust fan speed. Press "  " / "  " button to adjust fan blowing angle.

- When selecting heat mode, the air conditioner operates under heat mode. Press "▲" or "▼" button to adjust set temperature. Press "FAN" button to adjust fan speed. Press "  " / "  " button to adjust fan blowing angle.

Note:

- For preventing cold air, after starting up heat mode, indoor unit will delay 1~5 minutes to blow air (Actual delay time depends on indoor ambient temperature).
- Set temperature range from remote controller: 16-30°C(61-86°F).
- This mode indicator is not available for some models.
- Cooling only unit won't receive heat mode signal. If setting heat mode with remote controller, press "  " button can't start up the unit.

 button

Press this button can set fan speed circularly as: auto (auto), low (  ), low-medium (  ), medium (  ), medium-high (  ), high (  ).



Note:



- It's low fan speed under dry mode.
- X-FAN function: Holding fan speed button for 2s in cool or dry mode, the icon "  " is displayed and the indoor fan will continue operation for a few minutes in order to dry the indoor unit even though you have turned off the unit. After energization, X-FAN OFF is defaulted. X-FAN is not available in auto, fan or heat mode.

This function indicates that moisture on evaporator of indoor unit will be blown after the unit is stopped to avoid mould.

- Having set X-FAN function on: After turning off the unit by pressing "  " button, indoor fan will continue running for a few minutes at low speed. In this period, hold fan speed button for 2s to stop indoor fan directly.

Having set X-FAN function off: After turning off the unit by pressing "  " button, the complete unit will be off directly.

 button

Under cool or heat mode, press this button to turn to quick cool or quick heat mode. "  " icon is displayed on remote controller. Press this button again to exit turbo function and "  " icon will disappear.

If start this function, the unit will run at super-high fan speed to cool or heat quickly so that the ambient temperature approaches

the preset temperature as soon as possible.

 button

Press "▲" or "▼" button once to increase or decrease set temperature 1°C(°F). Holding "▲" or "▼" button, 2s later, set temperature on remote controller will change quickly. On releasing button after setting is finished, temperature indicator on indoor unit will change accordingly. (Temperature can't be adjusted under auto mode)



When setting TIMER ON, TIMER OFF or CLOCK, press "▲" or "▼" button to adjust time. (Refer to CLOCK, TIMER ON, TIMER OFF buttons).

 button

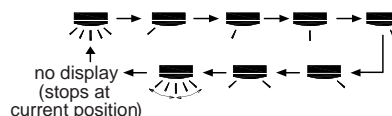
Press this button can select left & right swing angle. Fan blow angle can be selected circularly as below:









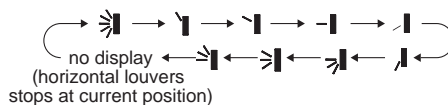

Note:

- Press this button continuously for more than 2s, the main unit will swing back and forth from left to right, and then loosen the button, the unit will stop swinging and present position of guide louver will be kept immediately.
- Under left and right swing mode, when the status is switched from off to  , if press this button again 2s later,  status will switch to off status directly; if press this button again within 2s, the change of swing status will also depend on the circulation sequence stated above.
- The function is only available for some models.

 button

Press this button can select up & down swing angle. Fan blow angle can be selected circularly as below:







- When selecting "  ", air conditioner is blowing fan automatically. Horizontal louver will automatically swing up & down at maximum angle.
- When selecting "  ,  ,  ,  ", air conditioner is blowing fan at fixed position. Horizontal louver will stop at the fixed position.
- When selecting "  ,  ,  ", air conditioner is blowing fan at





fixed angle. Horizontal louver will send air at the fixed angle.

- Hold "  " button above 2s to set your required swing angle. When reaching your required angle, release the button.

Note:

- "  ,  ,  " may not be available. When air conditioner receives this signal, the air conditioner will blow fan automatically.
- Press this button continuously for more than 2s, the main unit will swing back and forth from up to down, and then loosen the button, the unit present position of guide louver will be kept immediately.
- Under up and down swing mode, when the status is switched from off to  , if press this button again 2s later,  status will switch to off status directly; if press this button again within 2s, the change of swing status will also depend on the circulation sequencestated above.

SLEEP button



Press this button, can select Sleep 1 (), Sleep 2 (), Sleep 3 () and cancel the Sleep, circulate between these, after electrified, Sleep Cancel is defaulted.

- Sleep 1 is Sleep mode 1, in Cool modes; sleep status after run for one hour, the main unit setting temperature will increase 1 , two hours, setting temperature increased 2 , then the unit will run at this setting temperature; In Heat mode: sleep status after run for one hour, the setting temperature will decrease 1 , two hours, setting temperature will decrease 2 , then the unit will run at this setting temperature.

- Sleep 2 is sleep mode 2, that is air conditioner will run according to the presetting a group of sleep temperature curve.

- Sleep 3-the sleep curve setting under Sleep mode by DIY;

(1) Under Sleep 3 mode, press "Turbo" button for a long time, remote controller enters into user individuation sleep setting status, at this time, the time of remote controller will display "1hour", the setting temperature "88" will display the corresponding temperature of last setting sleep curve and blink (The first entering will display according to the initial curve setting value of original factory);

(2) Adjust " " and " " button, could change the corresponding setting temperature, after adjusted, press "Turbo" button for confirmation;

(3) At this time, 1hour will be automatically increased at the timer position on the remote control, (that are "2hours" or "3hours" or "8 hours" ), the place of setting temperature "88" will display the corresponding temperature of last setting sleep curve and blink;



(4) Repeat the above step (2)~(3) operation, until 8 hours temperature setting finished, sleep,curve setting finished, at this time, the remote controller will resume the original timer display; temperature display will resume to original setting temperature.

- Sleep 3-the sleep curve setting under Sleep mode by DIY could

be inquired:

The user could accord to sleep curve setting method to inquire the presetting sleep curve, enter into user individuation sleep setting status, but do not change the temperature, press "Turbo" button directly for confirmation. Note: In the above presetting or enquiry procedure, if continuously within 10s, there is no button pressed, the sleep curve setting within 10s, there is no button pressed , the sleep curve setting status will be automatically quit and resume to display the original displaying. In the presetting or enquiry procedure, press " " button, " Mode " button, " Sleep " button, the sleep curve setting or enquiry status will quit similarly.







I FEEL button

Press this button to start I FEEL function and " " will be displayed on the remote controller. After this function is set, the remote controller will send the detected ambient temperature to the controller and the unit will automatically adjust the indoor temperature according to the detected temperature. Press this button again to close I FEEL function and " " will disappear.

Please put the remote controller near user when this function is set. Do not put the remote controller near the object of high temperature or low temperature in order to avoid detecting inaccurate ambient temperature. When I FEEL function is turned on, the remote controller should be put within the area where indoor unit can receive the signal sent by the remote controller.

TIMER ON / TIMER OFF button







- TIMER ON button

"TIMER ON" button can set the time for timer on. After pressing this button, " " icon disappears and the word "ON" on remote controller blinks. Press " " or " " button to adjust TIMER ON setting. After each pressing of " " or " " button, TIMER ON setting will increase or decrease 1min. Holding " " or " " button, 2s later, the time will change quickly until reaching your required time.

Press "TIMER ON" to confirm it. The word "ON" will stop blinking.

" " icon resumes displaying. Cancel TIMER ON: Under the condition that TIMER ON is started up, press "TIMER ON" button to cancel it.

- TIMER OFF button

"TIMER OFF" button can set the time for timer off. After pressing this button, " " icon disappears and the word "OFF" on remote controller blinks. Press " " or " " button to adjust TIMER OFF setting. After each pressing of " " or " " button, TIMER OFF setting will increase or decrease 1min. Holding " " or " " button, 2s later, the time will change quickly until reaching your required time.

Press "TIMER OFF" and the word "OFF" will stop blinking. " "

icon resumes displaying. Under the condition that TIMER OFF is started up, press "TIMER OFF" button to cancel it.

Note:

- Under on and off status, you can set TIMER OFF or TIMER ON simultaneously.
- Before setting TIMER ON or TIMER OFF, please adjust the clock time.
- When turning on TIMER ON or TIMER OFF function, set this function valid all the time and the air conditioner will be turned on or turned off at set temperature every day. "⏸" button has no affect to setting. If this function is not required, use the remote controller to cancel it.

#### CLOCK button

Press this button to set clock time. "🕒" icon on remote controller will blink. Press "▲" or "▼" button within 5s to set clock time. Each pressing of "▲" or "▼" button, clock time will increase or decrease 1 min. If hold "▲" or "▼" button, 2s later, time will change quickly. Release this button when reaching your required time. Press "CLOCK" button to confirm the time. "🕒" icon stops blinking.

Note:

- Clock time adopts 24-hour mode.
- The interval between two operations can't exceed 5s. Otherwise, remote controller will quit setting status. Operation for TIMER ON/TIMER OFF is the same.

#### QUIET button

Press this button, the quiet status is under the auto quiet mode (display "🔇" and "Auto" signal) and quietmode (display "🔇" signal) and quiet off (there is no signal of "🔇" displayed), after powered on, the quietoff is defaulted.

Note:

- The quiet function is only available for some models.
  - The Quiet function can be set up in all modes; Under the Quiet mode, the fan speed is not available.
  - When quiet function is selected
- Under cooling mode: indoor fan operates at notch 4 speed. 10 minutes later or when indoor ambient temperature  $\leq 28^{\circ}\text{C}$ , indoor fan will operate at notch 2 speed or quiet mode according to the comparison between indoor ambient temperature and set temperature.
- Under heating mode: indoor fan operates at notch 3 speed or quiet mode according to the comparison between indoor ambient temperature and set temperature.
- Under dry, fan mode: indoor fan operates at quiet mode. Under auto mode: the indoor fan operates at the auto quiet mode according to actual cooling, heating or fan mode.

#### WiFi button

Press "WiFi" button to turn on WiFi function, "WiFi" icon will be displayed on the remote controller; Hold "WiFi" button for 5s to turn off WiFi function and "WiFi" icon will disappear.

Under off status, press "MODE" and "WiFi" buttons simultaneously for 1s, WiFi module will restore factory settings.

Note:

- This function is only available for some models.

#### LIGHT button

Press this button to turn off display light on indoor unit. "💡" icon on remote controller disappears. Press this button again to turn on display light. "💡" icon is displayed.

#### 🏠 button

Press this button to turn on or turn off the health and scavenging functions in operation status. Press this button for the first time to start scavenging function; LCD displays "🏠". Press the button for the second time to start health and scavenging functions simultaneously; LCD displays "🏠" and "🌿". Press this button for the third time to quit health and scavenging functions simultaneously.

Press the button for the fourth time to start health function; LCD display "🌿". Press this button again to repeat the operation above.

Note:

- This function is only available for some models.

#### TEMP button

By pressing this button, you can see indoor set temperature, indoor ambient temperature or outdoor ambient temperature on indoor unit's display. The setting on remote controller is selected circularly as below:



- When selecting "🏠" or no display with remote controller, temperature indicator on indoor unit displays set temperature.
- When selecting "🏠" with remote controller, temperature indicator on indoor unit displays indoor ambient temperature.
- When selecting "🏠!" with remote controller, temperature indicator on indoor unit displays outdoor ambient temperature.

Note:

- Outdoor temperature display is not available for some models. At that time, indoor unit receives "🏠!" signal, while it displays indoor set temperature.

- It's defaulted to display set temperature when turning on the unit. There is no display in the remote controller.
- Only for the models whose indoor unit has dual-8 display.
- When selecting displaying of indoor or outdoor ambient temperature, indoor temperature indicator displays corresponding temperature and automatically turn to display set temperature after three or five seconds.

## Function introduction for combination buttons

### Energy-saving function

Under cooling mode, press "TEMP" and "CLOCK" buttons simultaneously to start up or turn off energy-saving function. When energy-saving function is started up, "SE" will be shown on remote controller, and air conditioner will adjust the set temperature automatically according to ex-factory setting to reach to the best energy-saving effect. Press "TEMP" and "CLOCK" buttons simultaneously again to exit energy-saving function.

Note:

- Under energy-saving function, fan speed is defaulted at auto speed and it can't be adjusted.
- Under energy-saving function, set temperature can't be adjusted. Press "TURBO" button and the remote controller won't send signal.
- Sleep function and energy-saving function can't operate at the same time. If energy-saving function has been set under cool mode, press sleep button will cancel energy-saving function. If sleep function has been set under cool mode, start up the energy-saving function will cancel sleep function.

### 8°C heating function

Under heat mode, press "TEMP" and "CLOCK" buttons simultaneously to start up or turn off 8°C heating function. When this function is started up, "⊕" and "8°C" will be shown on remote controller, and the air conditioner keep the heating status at 8°C. Press "TEMP" and "CLOCK" buttons simultaneously again to exit 8°C heating function.

Note:

- Under 8°C heating function, fan speed is defaulted at auto speed and it can't be adjusted.
- Under 8°C heating function, set temperature can't be adjusted. Press "TURBO" button and the remote controller won't send signal.
- Sleep function and 8°C heating function can't operate at the same time. If 8°C heating function has been set under heat mode, press sleep button will cancel 8°C heating function. If sleep function has been set under heat mode, start up the 8°C heating function will cancel sleep function.

- Under °F temperature display, the remote controller will display 46°F heating.

### Child lock function

Press "▲" and "▼" simultaneously to turn on or turn off child lock function. When child lock function is on, "🔒" icon is displayed on remote controller. If you operate the remote controller, the "🔒" icon will blink three times without sending signal to the unit.

### Temperature display switchover function

Under OFF status, press "▼" and "MODE" buttons simultaneously to switch temperature display between °C and °F.

### Auto clean function

Under unit off status, hold "MODE" and "FAN" buttons simultaneously for 5s to turn on or turn off the auto clean function. When the auto clean function is turned on, indoor unit displays "CL". During the auto clean process of evaporator, the unit will perform fast cooling or fast heating. There may be some noise, which is the sound of flowing liquid or thermal expansion or cold shrinkage. The air conditioner may blow cool or warm air, which is a normal phenomenon. During cleaning process, please make sure the room is well ventilated to avoid affecting the comfort.

Note:

- The auto clean function can only work under normal ambient temperature. If the room is dusty, clean it once a month; if not, clean it once every three months. After the auto clean function is turned on, you can leave the room. When auto clean is finished, the air conditioner will enter standby status.
- This function is only available for some models.

### Night mode

Under cooling or heating mode, when turning on sleep mode and turn to low or quiet speed, the outdoor unit would enter into night mode.

Note:

- When you feel that the cooling and heating effect is poor, please press "FAN" button to other fan speed or press "SLEEP" button to exit the night mode. The night mode can only work under normal ambient temperature.
- This function is only available for some models.

## Replacement of batteries in remote controller

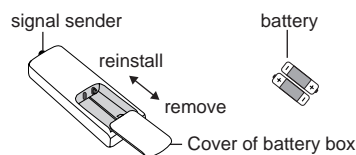

1. Press the back side of remote controller marked with "🔒", as

shown in the fig, and then push out the cover of battery box along the arrow direction.

2. Replace two 7# (AAA 1.5V) dry batteries, and make sure the position of "+" polar and "-" polar are correct.

3. Reinstall the cover of battery box.

**Notice:**

- During operation, point the remote control signal sender at the receiving window on indoor unit.
- The distance between signal sender and receiving window should be no more than 8m, and there should be no obstacles

between them.

- Signal may be interfered easily in the room where there is fluorescent lamp or wireless telephone; remote controller should be close to indoor unit during operation.
- Replace new batteries of the same model when replacement is required.
- When you don't use remote controller for a long time, please take out the batteries.
- If the display on remote controller is fuzzy or there's no display, please replace batteries.

## 6.3 Remote Controller Introduction for YAP1F2(WiFi)

### NOTE:

- This is a general use remote controller, it could be used for the air conditioners with multifunction; For some function, which the model doesn't have, if press the corresponding button on the remote controller that the unit will keep the original running status.
- After putting through the power, the air conditioner will give out a sound. Power indicator "⏻" is ON (red indicator, the colour is different for different models). After that, you can operate the air conditioner by using remote controller.
- Under on status, pressing the button on the remote controller, the signal icon "📶" on the display of remote controller will blink once and the air conditioner will give out a "di" sound, which means the signal has been sent to the air conditioner.

### Buttons on remote controller



#### ON/OFF

Press this button to turn on the unit. Press this button again to turn off the unit.

#### MODE

Press this button to select your required operation mode.



- When selecting auto mode, air conditioner will operate automatically according to ex-factory setting. Set temperature can't be adjusted and will not be displayed as well. Press "FAN" button can adjust fan speed. Press "🌀" / "🌀" button can adjust fan

blowing angle.

- After selecting cool mode, air conditioner will operate under cool mode. Press "▲" or "▼" button to adjust set temperature. Press "FAN" button to adjust fan speed. Press "🌀" / "🌀" button to adjust fan blowing angle.
- When selecting dry mode, the air conditioner operates at low speed under dry mode. Under dry mode, fan speed can't be adjusted. Press "🌀" / "🌀" button to adjust fan blowing angle.
- When selecting fan mode, the air conditioner will only blow fan, no cooling and no heating. All indicators are OFF. Press "FAN" button to adjust fan speed. Press "🌀" / "🌀" button to adjust fan blowing angle.
- When selecting heating mode, the air conditioner operates under heat mode. Press "▲" or "▼" button to adjust set temperature. Press "FAN" button to adjust fan speed. Press "🌀" / "🌀" button to adjust fan blowing angle. (Cooling only unit won't receive heating mode signal. If setting heat mode with remote controller, press ON/OFF button can't start up the unit).

### NOTE:

- For preventing cold air, after starting up heating mode, indoor unit will delay 1~5 minutes to blow air (actual delay time is depend on indoor ambient temperature).
- Set temperature range from remote controller: 16~30°C (61~86°F); Fan speed: auto, low speed, medium speed, high speed.
- This indicator is not available for some models.

#### FAN

Pressing this button can set fan speed circularly as: auto (AUTO), low(■), medium(■■), high(■■■).



### NOTE:

- Under AUTO speed, air conditioner will select proper fan speed automatically according to ex-factory setting.
- It's Low fan speed under Dry mode.
- X-FAN function Hold fan speed button for 2s in COOL or DRY mode, the icon "🌀" is displayed and the indoor fan will continue



operation for a few minutes in order to dry the indoor unit even though you have turned off the unit. After energization, X-FAN OFF is defaulted. X-FAN is not available in AUTO, FAN or HEAT mode. This function indicates that moisture on evaporator of indoor unit will be blown after the unit is stopped to avoid mould.

- Having set X-FAN function on: After turning off the unit by pressing ON/OFF button indoor fan will continue running for a few minutes. at low speed. In this period, Hold fan speed button for 2s to stop indoor fan directly.
- Having set X-FAN function off: After turning off the unit by pressing ON/OFF button, the complete unit will be off directly.



Under COOL or HEAT mode, press this button to turn to quick COOL or quick HEAT mode. "⊞" icon is displayed on remote controller. Press this button again to exit turbo function and "⊞" icon will disappear.

If start this function, the unit will run at super-high fan speed to cool or heat quickly so that the ambient temperature approaches the preset temperature as soon as possible.



Press "▲" or "▼" button once increase or decrease set temperature 1°C (°F). Holding "▲" or "▼" button, 2s later, set temperature on remote controller will change quickly. On releasing button after setting is finished, temperature indicator on indoor unit will change accordingly. (Temperature can't be adjusted under auto mode) When setting T-ON, T-OFF or CLOCK, press "▲" or "▼" button to adjust time. (Refer to CLOCK, T-ON, T-OFF buttons)



Press this button can select left & right swing angle. Fan blow angle can be selected circularly as below:

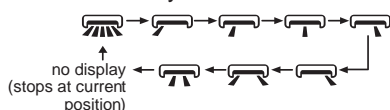

**NOTE:**

- Press this button continuously more than 2s, the main unit will swing back and forth from left to right, and then loosen the button, the unit will stop swinging and present position of guide louver will be kept immediately.
- Under swing left and right mode, when the status is switched from off to , if press this button again 2s later, status will switch to off status directly; if press this button again within 2s, the change of swing status will also depend on the circulation sequence stated above.
- This function only applicable for some models.



Press this button can select up & down swing angle. Fan blow angle can be selected circularly as below:

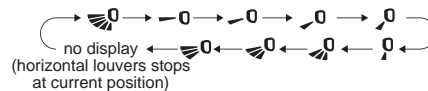

- When selecting " ", air conditioner is blowing fan automatically. Horizontal louver will automatically swing up & down at maximum angle.
- When selecting " , , , , ", air conditioner is blowing fan at fixed position. Horizontal louver will stop at the fixed position.
- When selecting " , , ", air conditioner is blowing fan at fixed angle.
- Hold " " button above 2s to set your required swing angle. When reaching your required angle, release the button.

**NOTE:**

- " , , " may not be available. When air conditioner receives this signal, the air conditioner will blow fan automatically.
- Press this button continuously more than 2s, the main unit will swing back and forth from up to down, and then loosen the button, the unit will stop swinging and present position of guide louver will be kept immediately.
- Under swing up and down mode, when the status is switched from off to , if press this button again 2s later, status will switch to off status directly; if press this button again within 2s, the change of swing status will also depend on the circulation sequence stated above.



- T-ON button

"T-ON" button can set the time for timer on. After pressing this button, "⊕" icon disappears and the word "ON" on remote controller blinks. Press "▲" or "▼" button to adjust T-ON setting. After each pressing "▲" or "▼" button, T-ON setting will increase or decrease 1min. Hold "▲" or "▼" button, 2s later, the time will change quickly until reaching your required time. Press "T-ON" to confirm it. The word "ON" will stop blinking. "⊕" icon resumes displaying. Cancel T-ON: Under the condition that T-ON is started up, press "T-ON" button to cancel it.

- T-OFF button



"T-OFF" button can set the time for timer off. After pressing this button, "⊕" icon disappears and the word "OFF" on remote controller blinks. Press "▲" or "▼" button to adjust T-OFF setting. After each pressing "▲" or "▼" button, T-OFF setting will increase or decrease 1min. Hold "▲" or "▼" button, 2s later, the time will change quickly until reaching your required time. Press "T-OFF" word "OFF" will stop blinking. "⊕" icon resumes displaying. Cancel T-OFF: Under the condition that T-OFF is started up, press "T-OFF" button to cancel it.

**NOTE:**

- Under on and off status, you can set T-OFF or T-ON simultaneously.









- Before setting T-ON or T-OFF, please adjust the clock time.
- After starting up T-ON or T-OFF, set the constant circulating valid.
- After that, air conditioner will be turned on or turned off according to setting time.ON/OFF button has no effect on setting. If you don't need this function, please use remote controller to cancel it.

#### I FEEL

Press this button to start I FEEL function and "  " will be displayed on the remote controller. After this function is set, the remote controller will send the detected ambient temperature to the controller and the unit will automatically adjust the indoor temperature according to the detected temperature. Press this button again to cancel I FEEL function and "  " will disappear.

- Please put the remote controller near user when this function is set. Do not put the remote controller near the object of high temperature or low temperature in order to avoid detecting inaccurate ambient temperature. When I FEEL function is turned on, the remote controller should be put within the area where indoor unit can receive the signal sent by the remote controller.

#### CLOCK



Press this button to set clock time. "  " icon on remote controller will blink. Press "  " or "  " button within 5s to set clock time. Each pressing of "  " or "  " button, clock time will increase or decrease 1 minute. If hold "  " or "  " button, 2s later, time will change quickly. Release this button when reaching your required time. Press "CLOCK" button to confirm the time. "  " icon stops blinking.

#### NOTE:

- Clock time adopts 24-hour mode.
- The interval between two operations can't exceed 5s. Otherwise, remote controller will quit setting status. Operation for T-ON/T-OFF is the same.

#### SLEEP

Under COOL or HEAT mode, press this button to start up sleep function.

"  " icon is displayed on remote controller. Press this button again to cancel sleep function and "  " icon will disappear. After powered on, Sleep Off is defaulted. After the unit is turned off, the Sleep function is canceled.

In this mode, set temperature will be adjusted with the change of time. Under Fan, DRY and Auto modes, this function is not available.

#### WiFi





Press " WiFi " button to turn on WiFi function, "WiFi " icon will be displayed on the remote controller; Hold " WiFi " button for 5s to turn off WiFi function and " WiFi " icon will disappear.

Under off status, press "MODE" and " WiFi " buttons simultaneously for 1s, WiFi module will restore factory settings.

#### NOTE:

- This function is only available for some models.

#### button

Press this button to achieve the on and off of health and scavenging functions in operation station. Press this button for the first time to start scavenging function; LCD displays "  ". Press the button for the second time to start health and scavenging functions simultaneously; LCD displays "  " and "  ". Press this button for the third time to quit health and scavenging functions simultaneously. Press the button for the fourth time to start health function; LCD display "  ". Press this button again to repeat the operation above.

#### NOTE:

- This function is applicable to partial of models.

#### LIGHT



Press this button to turn on or turn off the display light on the indoor unit.

The display light is defaulted on after energization.

#### TEMP

By pressing this button, you can see indoor set temperature, indoor ambient temperature or outdoor ambient temperature on indoor unit's display. The setting on remote controller is selected circularly as below:



- When selecting "  " or no display with remote controller, temperature indicator on indoor unit displays set temperature.
- When selecting "  " with remote controller, temperature indicator on indoor unit displays indoor ambient temperature.
- When selecting "  " with remote controller, temperature indicator on indoor unit displays outdoor ambient temperature.

#### NOTE:

- Outdoor temperature display is not available for some models. At that time, indoor unit receives "  " signal, while it displays indoor set temperature.
- It's defaulted to display set temperature when turning on the unit. There is no display in the remote controller.
- Only for the models whose indoor unit has dual-8 display.
- When selecting displaying of indoor or outdoor ambient temperature, indoor temperature indicator displays corresponding temperature and automatically turn to display set temperature after three or five seconds.

## Introduction for icons on display screen

	Set fan speed
	Send signal
	WiFi function
	Set temp.
	Indoor ambient temp.
	Outdoor ambient temp.
	Auto mode
	Cool mode
	Dry mode
	Fan mode
	Heat mode
	Set temperature
	8°C heating function
	Health mode
	Scavenging function
	X-FAN function
	I feel
	Child lock
	Quiet
	Turbo mode
	Sleep mode
	Clock
ON/OFF	TIMER ON / TIMER OFF
	Set time
	Up & down swing
	Left & right swing
	Power limiting operation

## Function introduction for combination buttons

### ● Energy-saving function

Under cooling mode, press "TEMP" and "CLOCK" buttons simultaneously to start up or turn off energysaving function. When energy-saving function is started up, "SE" will be shown on remote controller, and air conditioner will adjust the set temperature automatically according to ex-factorysetting to reach to the best energy-saving effect. Press "TEMP" and "CLOCK" buttons simultaneously again to exit energy-saving function.

#### NOTE:

- Under energy-saving function, fan speed is defaulted at auto speed and it can't be adjusted.
- Under energy-saving function, set temperature can't be adjusted. Press "TURBO" button and the remote controller won't send signal.
- Sleep function and energy-saving function can't operate at the same time. If energy-saving function has been set under cool mode, press sleep button will cancel energy-saving function. If sleep function has been set under cool mode, start up the energy-saving function will cancel sleep function.

### ● 8°C heating function

Under heat mode, press "TEMP" and "CLOCK" buttons simultaneously to start up or turn off 8°C heating function. When this function is started up, "8°C" and "8°C" will be shown on remote controller, and the air conditioner keep the heating status at 8°C.

Press "TEMP" and "CLOCK" buttons simultaneously again to exit 8°C heating function.

#### NOTE:

- Under 8°C heating function, fan speed is defaulted at auto speed and it can't be adjusted.
- Under 8°C heating function, set temperature can't be adjusted. Press "TURBO" button and the remote controller won't send signal.
- Sleep function and 8°C heating function can't operate at the same time. If 8°C heating function has been set under heat mode, press sleep button will cancel 8°C heating function. If sleep function has been set under heat mode, start up the 8°C heating function will cancel sleep function.
- Under °F temperature display, the remote controller will display 46°F heating.

### ● Child lock function

Press "▲" and "▼" simultaneously to turn on or turn off child lock function. When child lock function is on, "🔒" icon is displayed on remote controller. If you operate the remote controller, the "🔒" icon will blink three times without sending signal to the unit.

### ● Temperature display switchover function

Under OFF status, press "▼" and "MODE" buttons simultaneously to switch temperature display between °C and °F.

### ● Auto clean function

Under unit off status, hold "MODE" and "FAN" buttons simultaneously for 5s to turn on or turn off the auto clean function. When the auto clean function is turned on, indoor unit displays "CL". During the auto clean process of evaporator, the unit will perform fast cooling or fast heating. There may be some noise, which is the sound of flowing liquid or thermal expansion or cold shrinkage. The air conditioner may blow cool or warm air, which is a normal phenomenon. During cleaning process, please make sure the room is well ventilated to avoid affecting the comfort.

#### NOTE:

- The auto clean function can only work under normal ambient temperature. If the room is dusty, clean it once a month; if not, clean it once every three months. After the auto clean function is turned on, you can leave the room. When auto clean is finished, the air conditioner will enter standby status.
- This function is only available for some models.
- **Night mode**

Under cooling or heating mode, when turning on sleep mode and turn to low speed or quiet notch, the outdoor unit would enter into night mode.



**NOTE:**

- When you feel that the cooling and heating effect is poor, please press "FAN" button to other fan speed or press "SLEEP" button to exit the night mode.
- The night mode can only work under normal ambient temperature.
- This function is only available for some models.

**Replacement of batteries in remote controller**

1. Lift the cover along the direction of arrow (as shown in Fig 1 ① ).
2. Take out the original batteries (as shown in Fig 1 ② ).
3. Place two 7# (AAA 1.5V) dry batteries, and make sure the position of " + " polar and " - " polar is correct (as shown in Fig 2 ③ ).
4. Reinstall the cover (as shown in Fig 2 ④ ).

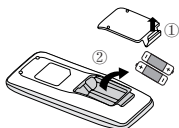

Fig.1

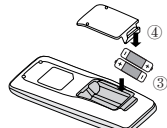

Fig.2

**NOTICE:**

- During operation, point the remote control signal sender at the receiving window on indoor unit.
- The distance between signal sender and receiving window should be no more than 8m, and there should be no obstacles between them.
- Signal may be interfered easily in the room where there is fluorescent lamp or wireless telephone; remote controller should be close to indoor unit during operation.
- Replace new batteries of the same model when replacement is required.
- When you don't use remote controller for a long time, please take out the batteries.
- If the display on remote controller is fuzzy or there's no display, please replace batteries.

## 6.4 Remote Controller Introduction for YAG1FB3(WiFi)

### Buttons on remote controller

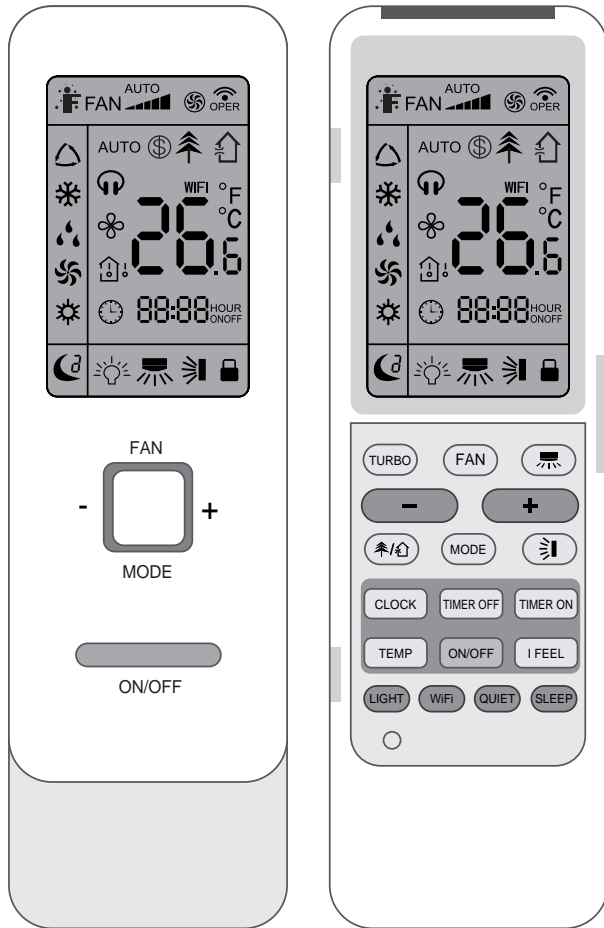

(before opening cover)

(after opening cover)

### Buttons on remote controller

	I feel	
	Set fan speed	
	Turbo mode	
	Send signal	
		Auto mode
		Cool mode
		Dry mode
		Fan mode
		Heat mode
		Sleep mode
	8°C heating function	
	Health mode	
	Scavenging function	
	WiFi function	
	Quiet	
	X-FAN function	
		Set temp.
		Indoor ambient temp.
		Outdoor ambient temp.
	Clock	
	Set temperature	
	Set time	
	TIMER ON / TIMER OFF	
	Light	
	Left & right swing	
	Up & down swing	
	Child lock	

### Introduction for buttons on remote controller

#### NOTICE:

- This is a general use remote controller. It could be used for the air conditioner with multifunction. For the functions which the model doesn't have, if press the corresponding button on the remote controller, the unit will keep the original running status.
- After putting through the power, the air conditioner will give out a sound. Operation indicator "ON" is ON. After that, you can operate the air conditioner by using remote controller.
- Under on status, pressing the button on the remote controller, the signal icon "WiFi" on the display of remote controller will blink once and the air conditioner will give out a "di" sound, which means the signal has been sent to the air conditioner.
- Under off status, set temperature and clock icon will be displayed on the display of remote controller (If timer on, timer off and light functions are set, the corresponding icons will be displayed on the display of remote controller at the same time);

Under on status, the display will show the corresponding set function icons.

#### 1. ON/OFF button

Press this button to turn on the unit. Press this button again to turn off the unit.

#### 2. FAN button

Press this button, Auto, Low, Medium-low, Medium, Medium-high, High speed can be circularly selected. After powered on, auto fan speed is default. Under dry mode, low fan speed only can be set up.

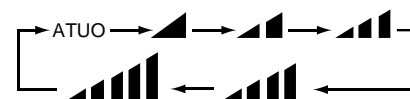

Low fan  
 Medium-low fan  
 Medium fan  
 Medium-high fan  
 High fan

## NOTICE:

- It's low fan speed under dry mode.
- X-FAN function: Hold fan speed button for 2s in cool or dry mode, the icon "☼" is displayed and the indoor fan will continue operation for a few minutes in order to dry the indoor unit even though you have turned off the unit. After energization, X-FAN OFF is defaulted. X-FAN is not available in auto, fan or heat mode.
- This function indicates that moisture on evaporator of indoor unit will be blown after the unit is stopped to avoid mould.
- Having set X-FAN function on: After turning off the unit by pressing ON/OFF button indoor fan will continue running for a few minutes. At low speed. In this period, hold fan speed button for 2s to stop indoor fan directly.
- Having set X-FAN function off: After turning off the unit by pressing ON/OFF button, the complete unit will be off directly.

### 3. MODE button

Press this button, auto, cool, dry, fan, heat mode can be selected circularly. Auto mode is default while power on. Under heat mode, the initial value is 28°C(82°F). Under other modes, the initial value is 25°C(77°F).



## NOTICE:

- Only for cooling and heating unit. As for cooling only unit, it won't have any action when it receives the signal of heating operation.

### 4. - / + button

Press " + " or " - " button once increase or decrease set temperature 0.1°C(°F). Holding " + " or " - " button, set temperature on remote controller will change quickly. On releasing button after setting is finished, temperature indicator on indoor unit will change accordingly.

When setting TIMER ON, TIMER OFF or CLOCK, press " + " or " - " button to adjust time. (Refer to CLOCK, TIMER ON, TIMER OFF buttons)

### 5. TURBO button



Press this button to activate / deactivate the Turbo function which enables the unit to reach the preset temperature in the shortest time. In cool mode, the unit will blow strong cooling air at super high fan speed. In heat mode, the unit will blow strong heating air at super high fan speed.

### 6. Swing button

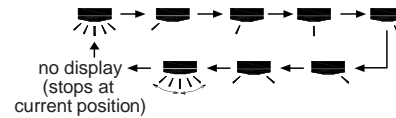
Press this button can select left & right swing angle. Fan blow angle can be selected circularly as below:











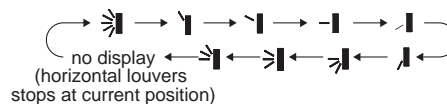

## NOTICE:

- Press this button continuously more than 2s, the main unit will swing back and forth from left to right, and then loosen the button, the unit will stop swinging and present position of guide louver will be kept immediately.
- Under left and right swing mode, when the status is switched from off to , if press this button again 2s later,  status will switch to off status directly; if press this button again within 2s, the change of swing status will also depend on the circulation sequence stated above.





### 7. Swing Angle button

Press this button can select up & down swing angle. Fan blow angle can be selected circularly as below:





- When selecting "  ", air conditioner is blowing fan automatically. Horizontal louver will automatically swing up & down at maximum angle.
- When selecting " , , , ,  ", air conditioner is blowing fan at fixed position. Horizontal louver will stop at the fixed position.
- When selecting " , ,  ", air conditioner is blowing fan at fixed angle. Horizontal louver will send air at the fixed angle.
- Hold "  " button above 2s to set your required swing angle. When reaching your required angle, release the button.

## NOTICE:

- " , ,  " may not be available. When air conditioner receives this signal, the air conditioner will blow fan automatically. Press this button continuously for more than 2s, the main unit will swing back and forth from up to down, and then loosen the button, the unit present position of guide louver will be kept immediately.
- Under up and down swing mode, when the status is switched from off to , if press this button again 2s later,  status will switch to off status directly; if press this button again within 2s, the change of swing status will also depend on the circulation sequence stated above.

### 8. CLOCK button

Press this button, the clock can be set up, signal  blink and display. Within 5 seconds, the value can be adjusted by pressing + or - button, if continuously press this button for 2 seconds above, in every 0.5 seconds, the value on ten place of Minute will be increased 1. During blinking, repress the clock button, signal  will be constantly displayed and it denotes the setting

succeeded. After powered on, 12:00 is defaulted to display and signal 🕒 will be displayed. If there is signal 🕒 be displayed that denotes the current time value is clock value, otherwise is timer value.

#### 9. **TIMER OFF / TIMER ON** button

- **Timer On setting:** Signal "ON" will blink and display, signal 🕒 will conceal, the numerical section will become the timer on setting status. During 5 seconds blink, by pressing + or - button to adjust the time value of numerical section, every press of that button, the value will be increased or decreased 1 minute. Hold pressing + or - button, 2 seconds later, it quickly change, the way of change is: During the initial 2.5 seconds, ten numbers change in the one place of minute, then the one place is constant, ten numbers change in the tens place of minute at 2.5 seconds speed and carry. During 5s blink, press the timer on button, the timer setting succeeds. The timer on has been set up, repress the timer on button, the timer on will be canceled. Before setting the timer, please adjust the clock to the current actual time.

- **Timer Off setting:** Signal "OFF" will blink and display, signal 🕒 will conceal, the numerical section will become the timer off setting status. The method of setting is the same as for TIMER ON.

#### 10. **TEMP** button

By pressing this button, you can see indoor set temperature, indoor ambient temperature or outdoor ambient temperature on indoor unit's display. The setting on remote controller selected circularly as below:



When selecting "🏠" with remote controller or no display, temperature indicator on indoor unit displays set temperature. When selecting "🏠🌡️" with remote controller, temperature indicator on indoor unit displays indoor ambient temperature; When selecting "🏠☀️" with remote controller, temperature indicator on indoor unit displays outdoor ambient temperature. 3s later it will return to the setting temperature or it depends on the other received signal within 3s.

Attention: When displaying the outdoor ambient, the displaying range is 0-60°C. When it goes beyond the range, it keeps the threshold data (The smallest — 0°C and the largest 60°C).

Warm tips: When operating buttons on the cover please make sure the cover is closed completely.

#### NOTICE:

- Outdoor temperature display is not available for some models. At that time, indoor unit receives "🏠☀️" signal, while it displays indoor set temperature.

#### 11. **🌡️/🏠** button

Press this button to achieve the on and off of health and scavenging functions in operation status. Press this button for the first time to start scavenging function simultaneously; LCD displays "🏠". Press the button for the second time to start health and scavenging functions simultaneously; LCD displays "🏠" and "🌡️". Press this button for the third time to quit health and scavenging functions simultaneously. Press the button for the fourth time to start health function; LCD display "🌡️".

Press this button again to repeat the operation above.

#### NOTICE:

- This function is applicable to partial of models.

#### 12. **I FEEL** button

Press this button to start I FEEL function and "🌡️" will be displayed on the remote controller. After this function is set, the remote controller will send the detected ambient temperature to the controller and the unit will automatically adjust the indoor temperature according to the detected temperature. Press this button again to close I FEEL function and "🌡️" will disappear.

Please put the remote controller near user when this function is set. Do not put the remote controller near the object of high temperature or low temperature in order to avoid detecting inaccurate ambient temperature. When I FEEL function is turned on, the remote controller should be put within the area where indoor unit can receive the signal sent by the remote controller.

#### 13. **LIGHT** button

Press this button to turn off display light on indoor unit. "🌞" icon on remote controller disappears. Press this button again to turn on display light. "🌞" icon is displayed.

#### 14. **WiFi** button

Press "WiFi" button simultaneously to turn on or turn off WIFI function. When WIFI function is turned on, the "WiFi" icon will be displayed on remote controller; Under status of unit off, long press "MODE" and "WiFi" buttons simultaneously for 1s, remote controller will send WIFI reset code and then the WIFI function will be turned on. WIFI function is defaulted OFF after energization of the remote controller.

#### NOTICE:

- This function is applicable to partial of models.

#### 15. **QUIET** button



Press this button, the Quiet status is under the Auto Quiet mode (display "🔇" and "AUTO" signal ) and Quiet mode (display "🔇" signal) and Quiet OFF (there is no signal of "🔇" displayed). After powered on, the Quiet OFF is defaulted.

Under the Quiet mode (Display "🔇" signal).

#### NOTICE:

- This function is applicable to partial of models.

## 16. button

- Press this button, can select Sleep 1 (  ), Sleep 2 (  ), Sleep 3 (  ) and cancel the sleep, circulate between these, after electrified, sleep cancel is defaulted.

- Sleep 1 is sleep mode 1, in cool modes: Sleep status after run for one hour, the main unit setting temperature will increase 1°C, 2 hours, setting temperature increased 2°C., the unit will run at this setting temperature; In heat mode: Sleep status after run for one hour, the setting temperature will decrease 1°C, 2 hours, setting temperature will decrease 2°C., then the unit will run at this setting temperature.

- Sleep 2 is sleep mode 2, that is air conditioner will run according to the presetting a group of sleep temperature curve.

### (a) In cool mode:

(1) When setting the initial temperature 16°C-23°C, after turned on sleep function, the temperature will be increased 1°C in every hour, after 3°C the temperature will be maintained, after 7 hours, the temperature will be decreased 1°C, after that the unit will keep on running under this temperature;

(2) When setting the initial temperature 24°C-27°C, after turned on sleep function, the temperature will be increased 1°C in every hour, after 2°C the temperature will be maintained, after 7 hours, the temperature will be decreased 1°C, after that the unit will keep on running under this temperature;

(3) When setting the initial temperature 28°C-29°C, after turned on sleep function, the temperature will be increased 1°C in every hour, after 1°C the temperature will be maintained, after 7 hours, the temperature will be decreased 1°C, after that the unit will keep on running under this temperature;

(4) When setting the initial temperature 30°C, under this temperature setting, after 7 hours, the temperature will be decreased 1°C, after that the unit will keep on running under this temperature;

### (b) In heat mode:

(1) Under the initial presetting temperature 16°C, it will run under this setting temperature all along.

(2) Under the initial presetting temperature 17°C-20°C, after sleep function started up, the temperature will decrease 1°C in every hour, after 1°C decreased, this temperature will be maintained.

(3) Under the initial presetting temperature 21°C-27°C, after sleep function started up, the temperature will decrease 1°C in every hour, after 2°C decreased, this temperature will be maintained.

(4) Under the initial presetting temperature 28°C-30°C, after Sleep function started up, the temperature will decrease 1°C in every hour, after 3°C decreased, this temperature will be maintained.

- Sleep 3 - the sleep curve setting under sleep mode by DIY:

(1) Under sleep 3 mode, press "Turbo" button for a long time, remote controller enters into user individuation sleep setting status, at this time, the time of remote controller will display "1 hour", the setting temperature "88" will display the corresponding temperature of last setting sleep curve and blink (The first entering will display according to the initial curve setting value of original factory);

(2) Adjust "+" and "-" button, could change the corresponding setting temperature, after adjusted, press "Turbo" button for confirmation;

(3) At this time, 1 hour will be automatically increased at the timer position on the remote controller, (that are "2 hours" or "3 hours" or "8 hours"), the place of setting temperature "88" will display the corresponding temperature of last setting sleep curve and blink;

(4) Repeat the above step (2)~(3) operation, until 8 hours temperature setting finished, sleep curve setting finished, at this time, the remote controller will resume the original timer display; temperature display will resume to original setting temperature.

- Sleep 3 - the sleep curve setting under sleep mode by DIY could be inquired:

The user could accord to sleep curve setting method to inquire the presetting sleep curve, enter into user individuation sleep setting status, but do not change the temperature, press "Turbo" button directly for confirmation.

### NOTICE:

- In the above presetting or enquiry procedure, if continuously within 10s, there is no button pressed, the sleep curve setting status will be automatically quit and resume to display the original displaying. In the presetting or enquiry procedure, press "ON/OFF" button, "Mode" button or "Sleep" button, the sleep curve setting or enquiry status will quit similarly.

## Introduction for special function

### 1. About AUTO RUN

When AUTO RUN mode is selected, the unit will be in accordance with the room temp. automatically to select the suitable running method and to make ambient comfortable.

### 2. About lock

Press + and - buttons simultaneously to lock or unlock the keyboard. If the remote controller is locked, the icon  will be displayed on it, in which case, press any button, the mark will flicker for three times. If the keyboard is unlocked, the mark will disappear.

### 3. About switch between Fahrenheit and Centigrade

Under status of unit off, press MODE and - buttons simultaneously to switch °C and °F.



#### 4. Combination of "TEMP" and "CLOCK" buttons: About Energy-saving Function

Press "TEMP" and "CLOCK" simultaneously in COOL mode to start energy-saving function. Nixie tube on the remote controller displays "SE". Repeat the operation to quit the function.

#### 5. Combination of "TEMP" and "CLOCK" buttons: About 8°C Heating Function

Press "TEMP" and "CLOCK" simultaneously in HEAT mode to start 8°C Heating Function. Nixie tube on the remote controller displays "8" and a selected temperature of "8°C".

(46°F if Fahrenheit is adopted). Repeat the operation to quit the function.

#### 6. About Quiet function

When quiet function is selected:

- (1) Under cool mode: Indoor fan operates at notch 4 speed. 10 minutes later or when indoor ambient temperature  $\leq 28^{\circ}\text{C}$ , indoor fan will operate at notch 2 speed or quiet mode according to the comparison between indoor ambient temperature and set temperature.
- (2) Under heat mode: Indoor fan operates at notch 3 speed or quiet mode according to the comparison between indoor ambient temperature and set temperature.
- (3) Under dry, fan mode: Indoor fan operates at quiet mode.
- (4) Under auto mode: The indoor fan operates at the auto quiet mode according to actual cool, heat or fan mode.

#### 7. About turbo function



If start this function, the unit will run at super-high fan speed to cool or heat quickly so that the ambient temp. approaches the preset temp. as soon as possible.

#### 8. About Sleep function

Under the fan, dry and auto mode, the sleep function cannot be set up, select and enter into any kind of sleep mode, the quiet function will be attached and started, different quiet status could be optional and turned off.

### Operation guide

#### 1. General operation

- (1) After powered on, press ON/OFF button, the unit will start to run. (Note: When it is powered on, the guide louver of main unit will close automatically.)
- (2) Press MODE button, select desired running mode.
- (3) Pressing + or - button, to set the desired temperature.
- (4) Pressing FAN button, set fan speed, can select AUTO FAN, LOW, MEDIUM-LOW, MEDIUM, MEDIUM-HIGH and HIGH.
- (5) Pressing  and  button, to select the swing.

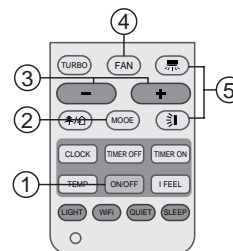

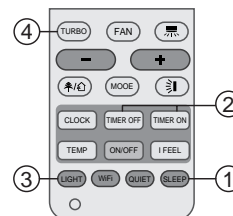

#### 2. Optional operation

- (1) Press SLEEP button, to set sleep.
- (2) Press TIMER ON and TIMER OFF button, can set the scheduled timer on or timer off.
- (3) Press LIGHT button, to control the on and off of the displaying part of the unit (This function may be not available for some units).
- (4) Press TURBO button, can realize the ON and OFF of TURBO function.

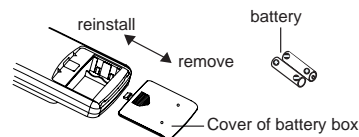

### Replacement of batteries in remote controller



1. Press the back side of remote controller marked with , as shown in the fig, and then push out the cover of battery box along the arrow direction.
2. Replace two 7# (AAA 1.5V) dry batteries, and make sure the position of "+" polar and "-" polar are correct.
3. Reinstall the cover of battery box.

#### NOTICE:

- During operation, point the remote control signal sender at the receiving window on indoor unit.
- The distance between signal sender and receiving window should be no more than 8m, and there should be no obstacles between them.
- Signal may be interfered easily in the room where there is fluorescent lamp or wireless telephone; remote controller should be close to indoor unit during operation.
- Replace new batteries of the same model when replacement is required.
- When you don't use remote controller for a long time, please take out the batteries.
- If the display on remote controller is fuzzy or there's no display, please replace batteries.

## 6.5 GREE+ App Operation Manual

### Control Flow Chart

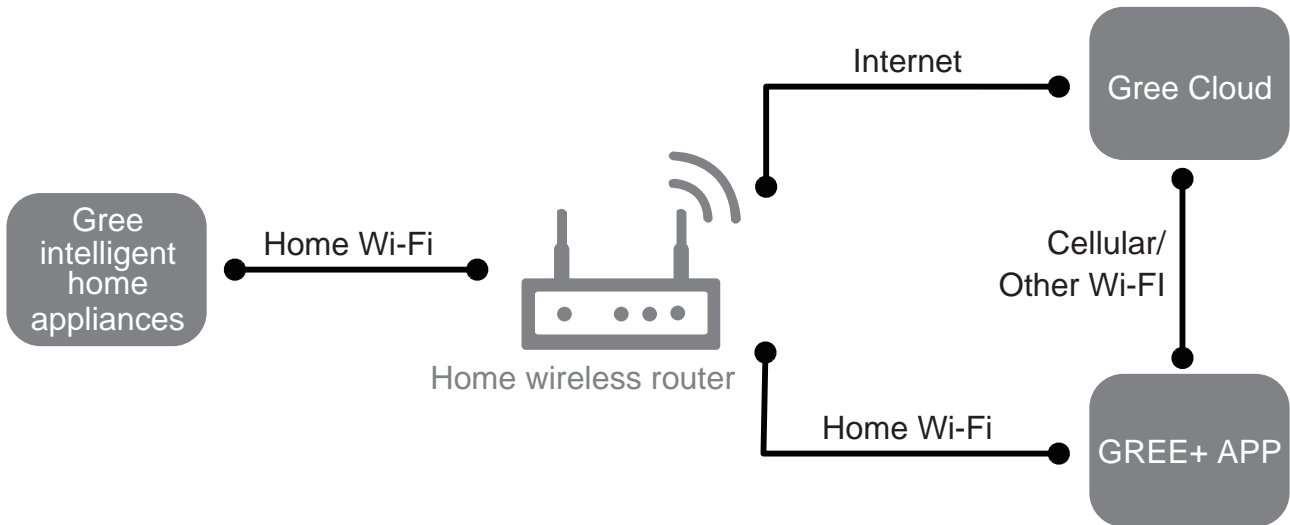

### Operating Systems

Requirement for User's smart phone:



iOS system  
Support iOS7.0 and  
above version



Android system  
Support Android 4.4 and  
above version

### Download and installation



GREE+ App Download Linkage

Scan the QR code or search "GREE+" in the application market to download and install it. When "GREE+" App is installed, register the account and add the device to achieve long-distance control and LAN control of Gree smart home appliances. For more information, please refer to "Help" in App.

## 6.6 Ewpe Smart App Operation Manual

### Control Flow Chart

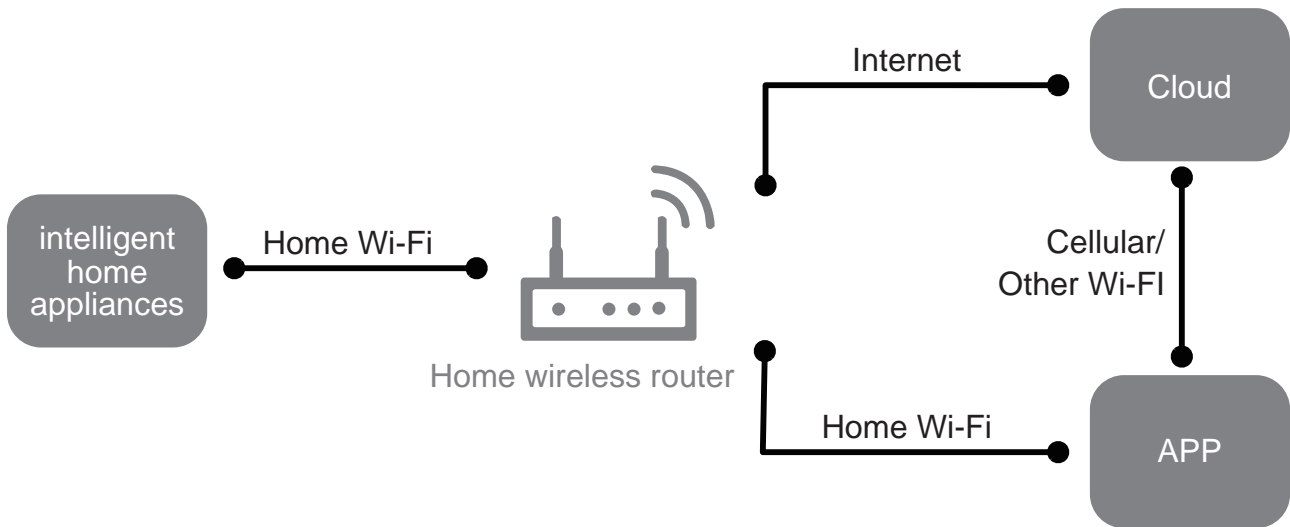

### Operating Systems

Requirement for User's smart phone:



iOS system  
Support iOS7.0 and  
above version



Android system  
Support Android 4.4 and  
above version

### Download and installation



App Download Linkage

Scan the QR code or search "Ewpe Smart" in the application market to download and install it. When "Ewpe Smart" App is installed, register the account and add the device to achieve long-distance control and LAN control of smart home appliances. For more information, please refer to "Help" in App.



## 6.7 Brief Description of Models and Functions

### ●Indoor Unit

#### 1.Basic function of system

##### (1)Cooling mode

(1) Under this mode, fan and swing operates at setting status. Temperature setting range is 16~30°C.

(2) During malfunction of outdoor unit or the unit is stopped because of protection, indoor unit keeps original operation status.

##### (2)Drying mode

(1) Under this mode, fan operates at low speed and swing operates at setting status. Temperature setting range is 16~30°C.

(2) During malfunction of outdoor unit or the unit is stopped because of protection, indoor unit keeps original operation status.

(3) Protection status is same as that under cooling mode.

(4) Sleep function is not available for drying mode.

##### (3)Heating mode

(1) Under this mode, Temperature setting range is 16~30°C.

(2) Working condition and process for heating mode:

When turn on the unit under heating mode, indoor unit enters into cold air prevention status. When the unit is stopped or at OFF status, and indoor unit has been started up just now, the unit enters into residual heat-blowing status.

##### (4)Working method for AUTO mode:

1.Working condition and process for AUTO mode:

a.Under AUTO mode, standard heating  $T_{\text{preset}}=20^{\circ}\text{C}$  and standard cooling  $T_{\text{preset}}=25^{\circ}\text{C}$ . The unit will switch mode automatically according to ambient temperature.

2.Protection function

a. During cooling operation, protection function is same as that under cooling mode.

b. During heating operation, protection function is same as that under heating mode.

3. Display: Set temperature is the set value under each condition. Ambient temperature is ( $T_{\text{amb.}}-T_{\text{compensation}}$ ) for heat pump unit and  $T_{\text{amb.}}$  for cooling only unit.

4. If theres I feel function,  $T_{\text{compensation}}$  is 0. Others are same as above.

##### (5)Fan mode

Under this mode, indoor fan operates at set fan speed. Compressor, outdoor fan, 4-way valve and electric heating tube stop operation. Indoor fan can select to operate at high, medium, low or auto fan speed. Temperature setting range is 16~30°C.

#### 2. Other control

##### (1) Buzzer

Upon energization or availably operating the unit or remote controller, the buzzer will give out a beep.

##### (2) Auto button

If press this auto button when turning off the unit, the complete unit will operate at auto mode. Indoor fan operates at auto fan speed and swing function is turned on. Press this auto button at ON status to turn off the unit.

##### (3) Auto fan

Heating mode: During auto heating mode or normal heating ode, auto fan speed will adjust the fan speed automatically according to ambient temperature and set temperature.

##### (4) Sleep

After setting sleep function for a period of time, system will adjust set temperature automatically.

##### (5) Timer function:

General timer and clock timer functions are compatible by equipping remote controller with different functions.

##### (6) Memory function

memorize compensation temperature, off-peak energization value. Memory content: mode, up&down swing, light, set temperature, set fan speed, general timer (clock timer Can't be memorized).

After power recovery, the unit will be turned on automatically according to memory content.

##### (7) Health function

During operation of indoor fan, set health function by remote controller. Turn off the unit will also turn off health function.

Turn on the unit by pressing auto button, and the health is defaulted ON.

##### (8)I feel control mode

After controller received I feel control signal and ambient temperature sent by remote controller, controller will work according to the ambient temperature sent by remote controller.

##### (9)Entry condition for compulsory defrosting function

When turn on the unit under heating ode and set temperature is 16°C (or 16.5°C by remote controller), press “ $\triangle$ ,  $\nabla$ ,  $\triangle$ ,  $\nabla$ ,  $\triangle$ ,  $\nabla$ ” button successively within 5s and then indoor unit will enter into compulsory defrosting setting status:

(1) If theres only indoor units controller, it enters into indoor normal defrosting mode.

(2) If theres indoor units controller and outdoor units controller, indoor unit will send compulsory defrosting mode signal to outdoor unit and then outdoor unit will operate under normal defrosting mode. After indoor unit received the signal that outdoor unit has entered into defrosting status, indoor unit will cancel to send compulsory mode to outdoor unit. If outdoor unit hasnt received feedback signal from outdoor unit after 3min, indoor unit will also cancel to send compulsory defrosting signal.

##### (10)Refrigerant recovery function:

Enter into Freon recovery mode actively: Within 5min after energization, turn on the unit at 16°C under cooling mode, and press light button for 3 times within 3s to enter into Freon recovery mode. Fo is displayed and Freon recovery mode will be sent to outdoor unit.

##### (11)Ambient temperature display control mode

1. When user set the remote controller to display set temperature (corresponding remote control code: 01), current set temperature will be displayed.

2. Only when remote control signal is switched to indoor ambient temperature display status (corresponding remote control code: 10) from other display status (corresponding remote control code: 00, 01,11),controller will display indoor ambient temperature for 3s and then turn back to display set temperature.

Under this mode, indoor fan operates at set fan speed. Compressor, outdoor fan, 4-way valve and electric heating tube stop operation. Indoor fan can select to operate at high, medium, low or auto fan speed. Temperature setting range is 16~30°C.

##### (12)Off-peak energization function:

Adjust compressors minimum stop time. The original minimum stop time is 180s and then we change to:

The time interval between two start-ups of compressor Can't be less than  $180+T_s(0\leq T_s\leq 15)$ . T is the variable of controller. Thats to say the minimum stop time of compressor is 180s~195s. Read-in T into memory chip when refurbish the memory chip each time.

After power recovery, compressor can only be started up after 180+T s at least.

### (13) SE control mode

The unit operates at SE status.

### (14) X-fan mode

When X-fan function is turned on, after turn off the unit, indoor fan will still operate at low speed for 2min and then the complete unit will be turned off. When x-fan function is turned off, after turn off the unit, the complete unit will be turned off directly.

### (15) 8°C heating function

Under heating mode, you can set 8°C heating function by remote controller. The system will operate at 8°C set temperature.

### (16) Turbo function

Turbo function can be set under cooling and heating modes. Press Fan Speed button to cancel turbo setting. Turbo function is not available under auto, drying and fan modes.

### (17) Auto cleaning function (only available on some models)

The automatic cleaning function of the indoor heat exchanger can be dedusted and sterilized by the condensation, frosting, defrosting and high temperature stages of the evaporator.

1. Under the power off, press and hold the "Internal Clean" button for 3 seconds while holding down the "MODE" and "FAN" buttons for 5 seconds to turn on the Auto Clean function. After the function is turned on, the air conditioner displays "CL".

2. The evaporator will be rapidly cooled or heated during the automatic cleaning process. There may be noise or even noise. The noise generated by the plastic parts due to thermal expansion and contraction is normal. During the cleaning and disinfection process, the room temperature may increase slightly, please keep the room well ventilated.

Tips:

The automatic cleaning function can only be started under normal environmental conditions. If the indoor environment is easy to dust, it is recommended to clean it once a month. If the indoor environment is not so dusty, it is recommended to clean it once every three months. After turning on the automatic cleaning mode, the user can leave the room. When cleaning is complete, the unit will automatically enter standby mode.

## ● Outdoor Unit

### 1. Cooling mode:

Working condition and process of cooling mode:

① When Tindoor ambient temperature  $\geq$  Tpreset, unit enters into cooling mode. Indoor fan, outdoor fan and compressor start operation. Indoor fan operates according to set fan speed.

② When Tindoor ambient temperature  $\leq$  Tpreset-2°C, compressor stops operation and outdoor fan will stop 30s later. Indoor fan operates according to set fan speed.

③ When Tpreset-2°C < Tindoor ambient temperature < Tpreset, unit operates according to the previous status.

Under cooling mode, 4-way valve is not energized. Temperature setting range is 16~30°C. If compressor stops because of malfunction in cooling mode, indoor fan and swing motor will work according to the original status.

### 2. Drying mode

(1) Working condition and process of drying mode

① When Tindoor ambient temperature > Tpreset, unit will be in drying mode. Outdoor fan and compressor start operation while indoor fan will operate at low fan speed.

② When Tpreset-2°C  $\leq$  Tindoor ambient temperature  $\leq$  Tpreset, unit

operates according to the previous status.

③ When Tindoor ambient temperature < Tpreset-2°C, compressor stops operation and outdoor fan will stop 30s later.

(2) Under drying mode, 4-way valve is not energized. Temperature setting range is 16~30°C.

(3) Protection function: same as in cooling mode.

### 3. Fan mode

(1) Under this mode, indoor fan can select different fan speed (except Turbo) or auto fan speed. Compressor, outdoor fan and 4-way valve all stop operation.

(2) In fan mode, temperature setting range is 16~30°C.

### 4. Heating mode

Working condition and process of heating mode:

① When Tpreset-(Tindoor ambient temperature-Tcompensation)  $\geq$  1°C, unit enters into heating mode. Compressor, outdoor fan and 4-way valve start operation.

② When -2°C < Tpreset-(Tindoor ambient temperature-Tcompensation) < 1°C, unit operates according to the previous status.

③ When Tpreset-(Tindoor ambient temperature-Tcompensation)  $\leq$  -2°C, compressor stops operation and outdoor fan will stop 30s later. Indoor fan will be in residual-heat blowing status.

④ When unit is turned off under heating mode or changed to other modes from heating mode, 4-way valve will be power-off 2min after compressor stops working (compressor is in operation status under heating mode).

⑤ When Toutdoor ambient temperature > 30°C, compressor stops operation immediately. Outdoor fan will stop 30s later.

⑥ Under the condition that compressor is turned on, when unit is changed to heating mode from cooling or drying mode, 4-way valve will be energized in 2~3mins delay.

Note: Tcompensation is determined by IDU and ODU. If IDU controls the compensation temperature, then Tcompensation is determined according to the value sent by IDU to ODU; If IDU does not control the compensation temperature, then Tcompensation will default to 3°C by the ODU.

### 5. Freon recovery mode

After the Freon recovery signal from IDU is received, cooling at rated frequency will be forcibly turned on to recover Freon.

Indoor unit will display Fo. If any signal from remote controller is received, unit will exit from Freon recovery mode and indoor unit stops displaying Fo.

### 6. Compulsory defrosting

If unit is turned on under heating mode and set temperature is 16OC (by remote controller), press "△, ▽, △, ▽, △, ▽" within 5s, unit will enter into compulsory defrosting mode and send the signal to ODU. When the compulsory defrosting signal from ODU is received, IDU will exit from the compulsory defrosting mode and stop sending the signal to ODU.

After ODU receives the compulsory defrosting code, it will start compulsory defrosting. Defrosting frequency and opening angle will be the same as in normal defrosting mode. When compulsory defrosting is finished, the complete unit resumes original status.

### 7. Auto mode

Auto mode is determined by controller of IDU. See IDU logic for details.

### **8. 8°C heating**

Set temperature is 8°C. Display board of IDU displays 8°C. Under this mode, "Cold air prevention" function is shielded.

If compressor is operating under this mode, fan speed will adjust according to auto fan speed; if compressor stops operation under this mode, indoor fan will be in residual-heat blowing status.

**When power on, communication light will be blinking in a normal way (after receiving a group of correct signals, blinking stops for 0.2s~0.3s). If there's no communication, communication light will be always on. If other ODU has malfunction, communication light will be on for 1s and off for 1s in a circular way.**

# 7. Notes for Installation and Maintenance

## Safety Precautions: Important!

Please read the safety precautions carefully before installation and maintenance.

The following contents are very important for installation and maintenance.

Please follow the instructions below.

- The installation or maintenance must accord with the instructions.
- Comply with all national electrical codes and local electrical codes.
- Pay attention to the warnings and cautions in this manual.
- All installation and maintenance shall be performed by distributor or qualified person.
- All electric work must be performed by a licensed technician according to local regulations and the instructions given in this manual.
- Be caution during installation and maintenance. Prohibit incorrect operation to prevent electric shock, casualty and other accidents.

## WARNINGS

### Electrical Safety Precautions:

1. Cut off the power supply of air conditioner before checking and maintenance.
2. The air condition must apply specialized circuit and prohibit share the same circuit with other appliances.
3. The air conditioner should be installed in suitable location and ensure the power plug is touchable.
4. Make sure each wiring terminal is connected firmly during installation and maintenance.
5. Have the unit adequately grounded. The grounding wire can't be used for other purposes.
6. Must apply protective accessories such as protective boards, cable-cross loop and wire clip.
7. The live wire, neutral wire and grounding wire of power supply must be corresponding to the live wire, neutral wire and grounding wire of the air conditioner.
8. The power cord and power connection wires can't be pressed by hard objects.
9. If power cord or connection wire is broken, it must be replaced by a qualified person.
10. If the power cord or connection wire is not long enough, please get the specialized power cord or connection wire from the manufacture or distributor. Prohibit prolong the wire

by yourself.

11. For the air conditioner without plug, an air switch must be installed in the circuit. The air switch should be all-pole parting and the contact parting distance should be more than 3mm.
12. Make sure all wires and pipes are connected properly and the valves are opened before energizing.
13. Check if there is electric leakage on the unit body. If yes, please eliminate the electric leakage.
14. Replace the fuse with a new one of the same specification if it is burnt down; Don't replace it with a cooper wire or conducting wire.
15. If the unit is to be installed in a humid place, the circuit breaker must be installed.

### Installation Safety Precautions:

1. Select the installation location according to the requirement of this manual. (See the requirements in installation part)
2. Handle unit transportation with care; the unit should not be carried by only one person if it is more than 20kg.
3. When installing the indoor unit and outdoor unit, a sufficient fixing bolt must be installed; make sure the installation support is firm.
4. Wear safety belt if the height of working is above 2m.
5. Use equipped components or appointed components during installation.
6. Make sure no foreign objects are left in the unit after finishing installation.

### Refrigerant Safety Precautions:

1. When refrigerant leaks or requires discharge during installation, maintenance, or disassembly, it should be handled by certified professionals or otherwise in compliance with local laws and regulations.
2. Avoid contact between refrigerant and fire as it generates poisonous gas; Prohibit prolong the connection pipe by welding.
3. Apply specified refrigerant only. Never have it mixed with any other refrigerant. Never have air remain in the refrigerant line as it may lead to rupture or other hazards.
4. Make sure no refrigerant gas is leaking out when installation is completed.
5. If there is refrigerant leakage, please take sufficient measure to minimize the density of refrigerant.
6. Never touch the refrigerant piping or compressor without wearing glove to avoid scald or frostbite.

Improper installation may lead to fire hazard, explosion, electric shock or injury.

# Safety Precautions for Installing and Relocating the Unit:

To ensure safety, please be mindful of the following precautions.

## WARNINGS

**1. When installing or relocating the unit, be sure to keep the refrigerant circuit free from air or substances other than the specified refrigerant.**

Any presence of air or other foreign substance in the refrigerant circuit will cause system pressure rise or compressor rupture, resulting in injury.

**2. When installing or moving this unit, do not charge the refrigerant which is not comply with that on the nameplate or unqualified refrigerant.**

Otherwise, it may cause abnormal operation, wrong action, mechanical malfunction or even series safety accident.

**3. When refrigerant needs to be recovered during relocating or repairing the unit, be sure that the unit is running in cooling mode. Then, fully close the valve at high pressure side (liquid valve). About 30~40 seconds later, fully close the valve at low pressure side (gas valve), immediately stop the unit and disconnect power. Please note that the time for refrigerant recovery should not exceed 1 minute.**

If refrigerant recovery takes too much time, air may be sucked in and cause pressure rise or compressor rupture, resulting in injury.

**4. During refrigerant recovery, make sure that liquid valve and gas valve are fully closed and power is disconnected before detaching the connection pipe.**

If compressor starts running when stop valve is open and connection pipe is not yet connected, air will be sucked in and cause pressure rise or compressor rupture, resulting in injury.

**5. When installing the unit, make sure that connection pipe is securely connected before the compressor starts running.**

If compressor starts running when stop valve is open and connection pipe is not yet connected, air will be sucked in and cause pressure rise or compressor rupture, resulting in injury.

**6. Prohibit installing the unit at the place where there may be leaked corrosive gas or flammable gas.**

If there leaked gas around the unit, it may cause explosion and other accidents.

**7. Do not use extension cords for electrical connections. If the electric wire is not long enough, please contact a local service center authorized and ask for a proper electric wire.**

Poor connections may lead to electric shock or fire.

**8. Use the specified types of wires for electrical connections between the indoor and outdoor units. Firmly clamp the wires so that their terminals receive no external stresses.**

Electric wires with insufficient capacity, wrong wire connections and insecure wire terminals may cause electric shock or fire.



## Safety Precautions for Refrigerant

●To realize the function of the air conditioner unit, a special refrigerant circulates in the system. The used refrigerant is the fluoride R32, which is specially cleaned. The refrigerant is flammable and odorless. Furthermore, it can lead to explosion under certain conditions. But the flammability of the refrigerant is very low. It can be ignited only by fire.

●Compared to common refrigerants, R32 is a nonpolluting refrigerant with no harm to the ozone layer. The influence upon the greenhouse effect is also lower. R32 has got very good thermodynamic features which lead to a really high energy efficiency. The units therefore need a less filling.

### WARNING:

●Do not use means to accelerate the defrosting process or to clean, other than those recommended by the manufacturer.

Should repair be necessary, contact your nearest authorized Service Centre. Any repairs carried out by unqualified personnel may be dangerous. The appliance shall be stored in a room without continuously operating ignition sources. (for example: open flames, an operating gas appliance or an operating electric heater.)

●Do not pierce or burn.

●Appliance shall be installed, operated and stored in a room with a floor area larger than  $Xm^2$ .

●Appliance filled with flammable gas R32. For repairs, strictly follow manufacturer's instructions only. Be aware that refrigerants do not contain odor.

●Read specialist manual.

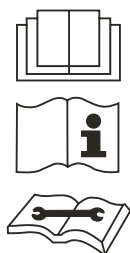

This appliance is not intended for use by persons (including children) with reduced physical, sensory or mental capabilities, or lack of experience and knowledge, unless they have been given supervision or instruction concerning use of the appliance by a person responsible for their safety. Children should be supervised to ensure that they do not play with the appliance.



R32: 675

This marking indicates that this product should not be disposed with other household wastes. To prevent possible harm to the environment or human health from uncontrolled waste throughout the EU. To prevent possible harm to the environment or human health.

From uncontrolled waste disposal, recycle it responsibly to promote the sustainable reuse of material resources. To return your used device, please use the return and collection systems or contact the retailer where the product was purchased. They can take this product for environmental safe recycling.

If it needs to be installed, moved or maintained, please contact dealer or local service center to conduct it at first. Air conditioner must be installed, moved or maintained by appointed unit. Otherwise, it may cause serious damage or personal injury or death.

## Safety Operation of Flammable Refrigerant Qualification requirement for installation and maintenance man

●Any person who is involved with working on or breaking into a refrigerant circuit should hold a current valid certificate from an industry-accredited assessment authority, which authorizes their competence to handle refrigerants safely in accordance with an industry recognized assessment specification.

●Servicing shall only be performed as recommended by the equipment manufacturer. Maintenance and repair requiring the assistance of other skilled personnel shall be carried out under the supervision of the person competent in the use of flammable refrigerants.

### Installation notes

●The air conditioner is not allowed to be used in a room that has running fire (such as fire source, working coal gas, operating heater).

●It is not allowed to drill a hole or burn the connection pipe.

●The air conditioner must be installed in a room that is larger than the minimum room area.

The minimum room area is shown on the nameplate or following table a.

●Leak test is a must after installation.

table a - Minimum room area (  $m^2$  )

Charge amount (kg)	Floor location	Window mounted	Wall mounted	Ceiling mounted
≤1.2	4	4	4	4
1.3	14.5	5.2	4	4
1.4	16.8	6.1	4	4
1.5	19.3	7	4	4
1.6	22	7.9	4	4
1.7	24.8	8.9	4	4
1.8	27.8	10	4	4
1.9	31	11.2	4	4
2.0	34.3	12.4	4	4
2.1	37.8	13.6	4.2	4
2.2	41.5	15	4.6	4
2.3	45.4	16.3	5	4
2.4	49.4	17.8	5.5	4
2.5	53.6	19.3	6	4

### Maintenance notes

- Check whether the maintenance area or the room area meet the requirement of the nameplate.
  - Its only allowed to be operated in the rooms that meet the requirement of the nameplate.
- Check whether the maintenance area is well-ventilated.
  - The continuous ventilation status should be kept during the operation process.
- Check whether there is fire source or potential fire source in the maintenance area.
  - The naked flame is prohibited in the maintenance area; and the “no smoking” warning board should be hanged.
- Check whether the appliance mark is in good condition.
  - Replace the vague or damaged warning mark.

### Welding

- If you should cut or weld the refrigerant system pipes in the process of maintaining, please follow the steps as below:
  - a. Shut down the unit and cut power supply
  - b. Eliminate the refrigerant
  - c. Vacuuming
  - d. Clean it with N<sub>2</sub> gas
  - e. Cutting or welding
  - f. Carry back to the service spot for welding
  - Make sure that there isnt any naked flame near the outlet of the vacuum pump and its well-ventilated.
  - The refrigerant should be recycled into the specialized storage tank.

### Filling the refrigerant

- Use the refrigerant filling appliances specialized for R32. Make sure that different kinds of refrigerant wont contaminate with each other.
- The refrigerant tank should be kept upright at the time of filling refrigerant.
- Stick the label on the system after filling is finished (or havent finished).
- Dont overfilling.
- After filling is finished, please do the leakage detection before test running; another time of leak detection should be done when its removed.

### Safety instructions for transportation and storage

- Please use the flammable gas detector to check before unload and open the container.
- No fire source and smoking.
- According to the local rules and laws.

Prior to beginning work on systems containing flammable refrigerants, safety checks are necessary to ensure that the risk of ignition is minimised. For repair to the refrigerating system, the following precautions shall be complied with prior to conducting work on the system.

#### ● Work procedure

Work shall be undertaken under a controlled procedure so as to minimise the risk of a flammable gas or vapour being present while the work is being performed.

#### ● General work area

All maintenance staff and others working in the local area shall be instructed on the nature of work being carried out. Work in confined spaces shall be avoided. The area around the workspace shall be sectioned off. Ensure that the conditions within the area have been made safe by control of flammable material

#### ● Checking for presence of refrigerant

The area shall be checked with an appropriate refrigerant detector prior to and during work, to ensure the technician is aware of potentially toxic or flammable atmospheres.

Ensure that the leak detection equipment being used is suitable for use with all applicable refrigerants, i.e. non-sparking, adequately sealed or intrinsically safe.

#### ● Presence of fire extinguisher

If any hot work is to be conducted on the refrigeration equipment or any associated parts, appropriate fire extinguishing equipment shall be available to hand. Have a dry powder or CO<sub>2</sub> fire extinguisher adjacent to the charging area.

#### ●No ignition sources

No person carrying out work in relation to a refrigeration system which involves exposing any pipe work shall use any sources of ignition in such a manner that it may lead to the risk of fire or explosion. All possible ignition sources, including cigarette smoking, should be kept sufficiently far away from the site of installation, repairing, removing and disposal, during which refrigerant can possibly be released to the surrounding space. Prior to work taking place, the area around the equipment is to be surveyed to make sure that there are no flammable hazards or ignition risks. "NO Smoking" signs shall be displayed.

#### ●Ventilated area

Ensure that the area is in the open or that it is adequately ventilated before breaking into the system or conducting any hot work. A degree of ventilation shall continue during the period that the work is carried out. The ventilation should safely disperse any released refrigerant and preferably expel it externally into the atmosphere.

#### ●Checks to the refrigeration equipment

Where electrical components are being changed, they shall be fit for the purpose and to the correct specification. At all times the manufacturer's maintenance and service guidelines shall be followed. If in doubt, consult the manufacturer's technical department for assistance.

*The following checks shall be applied to installations using flammable refrigerants:*

- The actual refrigerant charge is in accordance with the room size within which the refrigerant containing parts are installed;
- The ventilation machinery and outlets are operating adequately and are not obstructed;
- If an indirect refrigerating circuit is being used, the secondary circuit shall be checked for the presence of refrigerant;
- Marking to the equipment continues to be visible and legible. Markings and signs that are illegible shall be corrected;
- Refrigeration pipe or components are installed in a position where they are unlikely to be exposed to any substance which may corrode refrigerant containing components, unless the components are constructed of materials which are inherently resistant to being corroded or are suitably protected against being so corroded.

#### ●Checks to electrical devices

Repair and maintenance to electrical components shall include initial safety checks and component inspection procedures. If a fault exists that could compromise safety, then no electrical supply shall be connected to the circuit until it is satisfactorily dealt with. If the fault cannot be corrected immediately but it is necessary to continue operation, an adequate temporary solution shall be used. This shall be reported to the owner of the equipment so all parties are advised.

#### Initial safety checks shall include:

1. That capacitors are discharged: this shall be done in a safe manner to avoid possibility of sparking;
2. That no live electrical components and wiring are exposed while charging, recovering or purging the system;
3. That there is continuity of earth bonding.

#### ●Repairs to sealed components

1. During repairs to sealed components, all electrical supplies shall be disconnected from the equipment being worked upon prior to any removal of sealed covers, etc. If it is absolutely necessary to have an electrical supply to equipment during servicing, then a permanently operating form of leak detection shall be located at the most critical point to warn of a potentially hazardous situation.

2. Particular attention shall be paid to the following to ensure that by working on electrical components, the casing is not altered in such a way that the level of protection is affected. This shall include damage to cables, excessive number of connections, terminals not made to original specification, damage to seals, incorrect fitting of glands, etc.

Ensure that the apparatus is mounted securely.

Ensure that seals or sealing materials have not degraded to the point that they no longer serve the purpose of preventing the ingress of flammable atmospheres.

Replacement parts shall be in accordance with the manufacturer's specifications.

NOTE : The use of silicon sealant can inhibit the effectiveness of some types of leak detection equipment. Intrinsically safe components do not have to be isolated prior to working on them.

#### ●Repair to intrinsically safe components

Do not apply any permanent inductive or capacitance loads to the circuit without ensuring that this will not exceed the permissible voltage and current permitted for the equipment in use.

Intrinsically safe components are the only types that can be worked on while live in the presence of a flammable atmosphere. The test apparatus shall be at the correct rating.

Replace components only with parts specified by the manufacturer. Other parts may result in the ignition of refrigerant in the atmosphere from a leak.

#### ●Cabling

Check that cabling will not be subject to wear, corrosion, excessive pressure, vibration, sharp edges or any other adverse environmental effects. The check shall also take into account the effects of aging or continual vibration from sources such as compressors or fans.

#### ●Detection of flammable refrigerants

Under no circumstances shall potential sources of ignition be used in the searching for or detection of refrigerant leaks. A halide torch



(or any other detector using a naked flame) shall not be used.

●**Leak detection methods**

The following leak detection methods are deemed acceptable for all refrigerant systems.

Electronic leak detectors may be used to detect refrigerant leaks but, in the case of flammable refrigerants, the sensitivity may not be adequate, or may need re-calibration.

(Detection equipment shall be calibrated in a refrigerant-free area.) Ensure that the detector is not a potential source of ignition and is suitable for the refrigerant used.

Leak detection equipment shall be set at a percentage of the LFL of the refrigerant and shall be calibrated to the refrigerant employed, and the appropriate percentage of gas (25 % maximum) is confirmed.

Leak detection fluids are suitable for use with most refrigerants but the use of detergents containing chlorine shall be avoided as the chlorine may react with the refrigerant and corrode the copper pipe-work.

If a leak is suspected, all naked flames shall be removed/ extinguished.

If a leakage of refrigerant is found which requires brazing, all of the refrigerant shall be recovered from the system, or isolated (by

means of shut off valves) in a part of the system remote from the leak. For appliances containing flammable refrigerants, oxygen free nitrogen (OFN) shall then be purged through the system both before and during the brazing process.

●**Removal and evacuation**

When breaking into the refrigerant circuit to make repairs – or for any other purpose –conventional procedures shall be used. However, for flammable refrigerants it is important that best practice is followed since flammability is a consideration. The following procedure shall be adhered to:

- 1.remove refrigerant;
- 2.purge the circuit with inert gas; evacuate;
- 3.purge again with inert gas;
- 4.open the circuit by cutting or brazing.

The refrigerant charge shall be recovered into the correct recovery cylinders.

For appliances containing flammable refrigerants, the system shall be “flushed” with OFN to render the unit safe. This process may need to be repeated several times. Compressed air or oxygen

# UV-C lamp function instruction (For some models)

---

## WARNINGS

This appliance contains a UV emitter. Do not stare at the light source.

- This appliance contains a UV-C lamp.
- Read the maintenance instructions before opening the appliance.
- Details for cleaning and other user maintenance of the appliance:
  1. Prior to cleaning or other maintenance, the appliance must be disconnected from the supply mains.
  2. Open the panel to take out the filter.
  3. Use a soft cotton cloth to wipe the quartz glass until it's clean.
  4. Reinstall the filter when it has been cleaned and then close the panel cover.
- The method, frequency of cleaning, and necessary precautions to be taken:

Cleaning method: wipe the quartz glass with soft cloth until the surface is clean.

Cleaning frequency: clean it every 6 months; the cleaning frequency can be properly adjusted according to the degree of air cleanliness.

Preventive measures:

  1. The unit must be turned off and the power must be cut off before cleaning. Otherwise, it may cause electric shock and damage by UV.
  2. Do not use volatile oil, alcohol, diluents or lacquer to clean the UV-C lamp. Otherwise, the UV-C lamp may be damaged.
  3. Do not touch the fins of indoor unit to prevent scalding.
  4. Do not scratch the surface of glass when wiping it.
- Unintended use of the appliance or damage to the housing may result in the escape of dangerous UV-C radiation. UV-C radiation may, even in small doses, cause harm to the eyes and skin.
- Appliances that are obviously damaged must not be operated.
- Before opening doors and access panels bearing the ultraviolet radiation hazard Symbol for the conducting user maintenance, it is recommended to disconnect the power.
- UV-C barriers bearing the ultraviolet radiation hazard symbol should not be removed.
- Do not operate UV-C lamps outside of the appliance.

## WARNINGS

Do not operate the UV-C emitter when it is removed from the appliance.

- To avoid any dangerous situations, shall not replace the UV-C lamp.

# Main Tools for Installation and Maintenance



Level meter



Measuring tape



Screw driver



Impact drill



Drill head



Electric drill



Electroprobe



Universal meter



Torque wrench



Open-end wrench



Inner hexagon spanner



Electronic leakage detector



Vacuum pump



Pressure meter



Pipe pliers



Pipe pliers



Pipe cutter



Pipe expander



Pipe bender



Soldering appliance



Refrigerant container



Electronic scale

# 8. Installation

## 8.1 Installation Dimension Diagram

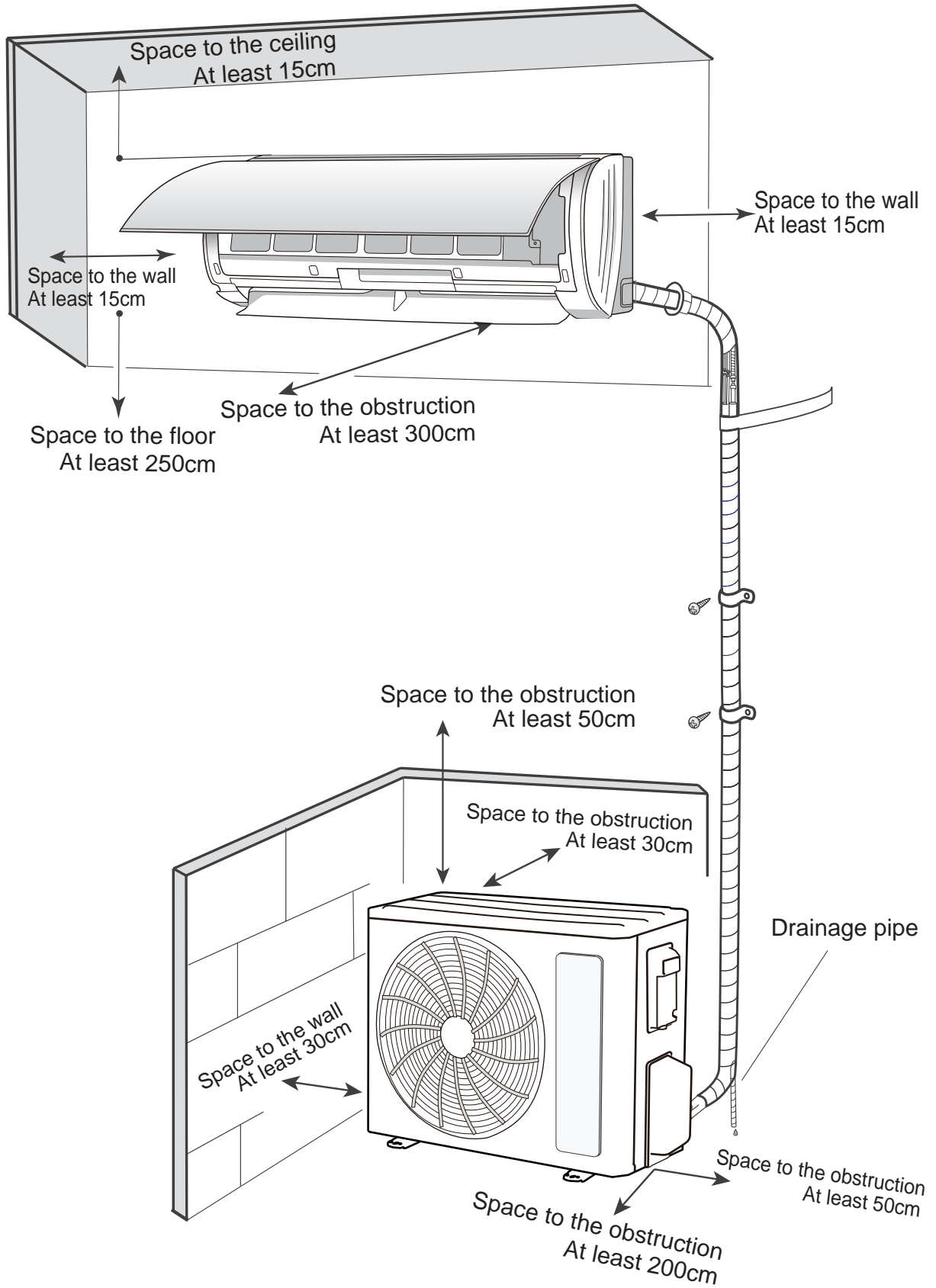

## Installation Procedures

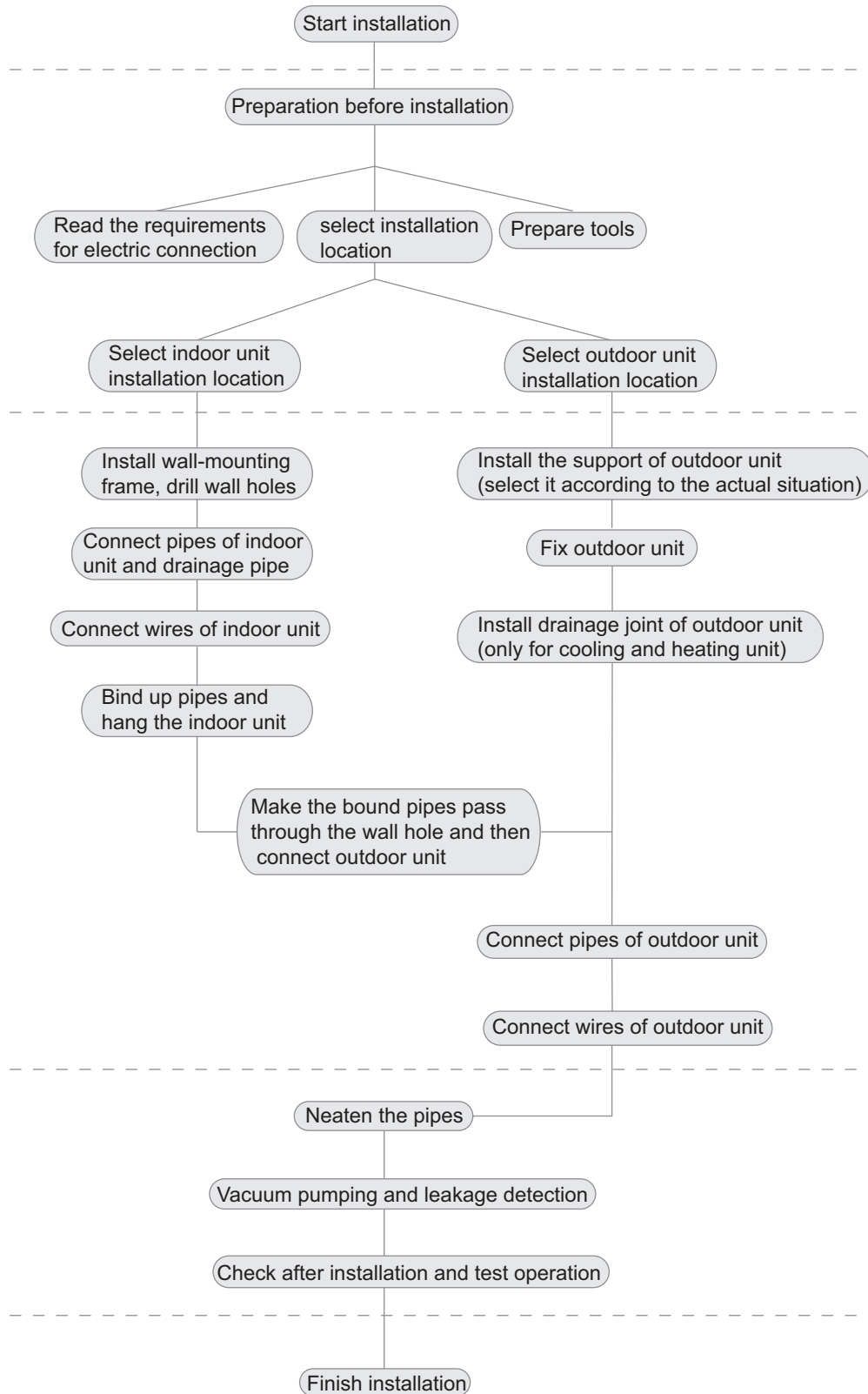

Note: this flow is only for reference; please find the more detailed installation steps in this section.

## 8.2 Installation Parts-checking

No.	Name
1	Indoor unit
2	Outdoor unit
3	Connection pipe
4	Drainage pipe
5	Wall-mounting frame
6	Connecting cable(power cord)
7	Wall pipe
8	Sealing gum
9	Wrapping tape
10	Support of outdoor unit
11	Fixing screw
12	Drainage plug(cooling and heating unit)
13	Owners manual, remote controller

### ⚠ Note:

- 1.Please contact the local agent for installation.
- 2.Dont use unqualified power cord.

## 8.3 Selection of Installation Location

### 1. Basic Requirement:

Installing the unit in the following places may cause malfunction. If it is unavoidable, please consult the local dealer:

- (1) The place with strong heat sources, vapors, flammable or explosive gas, or volatile objects spread in the air.
- (2) The place with high-frequency devices (such as welding machine, medical equipment).
- (3) The place near coast area.
- (4) The place with oil or fumes in the air.
- (5) The place with sulfured gas.
- (6) Other places with special circumstances.
- (7) The appliance shall not be installed in the laundry.
- (8) It's not allowed to be installed on the unstable or motive base structure(such as truck) or in the corrosive environment (such as chemical factory).

### 2. Indoor Unit:

- (1) There should be no obstruction near air inlet and air outlet.
- (2) Select a location where the condensation water can be dispersed easily and wont affect other people.
- (3) Select a location which is convenient to connect the outdoor unit and near the power socket.
- (4) Select a location which is out of reach for children.
- (5) The location should be able to withstand the weight of indoor unit and wont increase noise and vibration.
- (6) The appliance must be installed 2.5m above floor.
- (7) Dont install the indoor unit right above the electric appliance.
- (8) Please try your best to keep way from fluorescent lamp.

### 3. Outdoor Unit:

- (1) Select a location where the noise and outflow air emitted by the outdoor unit will not affect neighborhood.
- (2) The location should be well ventilated and dry, in which the outdoor unit wont be exposed directly to sunlight or strong wind.

- (3) The location should be able to withstand the weight of outdoor unit.
- (4) Make sure that the installation follows the requirement of installation dimension diagram.
- (5) Select a location which is out of reach for children and far away from animals or plants.If it is unavoidable, please add fence for safety purpose.

## 8.4 Electric Connection Requirement

### 1. Safety Precaution

- (1) Must follow the electric safety regulations when installing the unit.
- (2) According to the local safety regulations, use qualified power supply circuit and air switch.
- (3) Make sure the power supply matches with the requirement of air conditioner. Unstable power supply or incorrect wiring may result in electric shock,fire hazard or malfunction. Please install proper power supply cables before using the air conditioner.
- (4) Properly connect the live wire, neutral wire and grounding wire of power socket.
- (5) Be sure to cut off the power supply before proceeding any work related to electricity and safety.
- (6) Do not put through the power before finishing installation.
- (7) If the supply cord is damaged, it must be replaced by the manufacturer, its service agent or similarly qualified persons in order to avoid a hazard .
- (8) The temperature of refrigerant circuit will be high, please keep the interconnection cable away from the copper tube.
- (9) The appliance shall be installed in accordance with national wiring regulations.
- (10) Appliance shall be installed, operated and stored in a room with a floor area larger than  $Xm^2$ (Please refer to table "a" in section of " Safety Operation of Inflammable Refrigerant" for Space X.)



Please notice that the unit is filled with flammable gas R32. Inappropriate treatment of the unit involves the risk of severe damages of people and material. Details to this refrigerant are found in chapter "refrigerant".

### 2. Grounding Requirement:

- (1) The air conditioner is the first class electric appliance.It must be properly grounding with specialized grounding device by a professional.  
Please make sure it is always grounded effectively,otherwise it may cause electric shock.
- (2) The yellow-green wire in air conditioner is grounding wire, which Can't be used for other purposes.
- (3) The grounding resistance should comply with national electric safety regulations.
- (4) The appliance must be positioned so that the plug is accessible.
- (5) An all-pole disconnection switch having a contact separation of at least 3mm in all poles should be connected in fixed wiring.
- (6) Including an air switch with suitable capacity, please note the following table. Air switch should be included magnet buckle and heating buckle function, it can protect the circuit-short and overload. (Caution: please do not use the fuse only for protect the circuit)

Model	Air switch capacity	Power cord
07K / 09K / 12K	10A	3G1.0
18K 24K(ACD)	16A	3G1.5
24K(ACE)	25A	3G2.5

## 8.5 Installation of Indoor Unit

### 1. Choosing Installation location

Recommend the installation location to the client and then confirm it with the client.

### 2. Install Wall-mounting Frame

(1) Hang the wall-mounting frame on the wall; adjust it in horizontal position with the level meter and then point out the screw fixing holes on the wall.

(2) Drill the screw fixing holes on the wall with impact drill (the specification of drill head should be the same as the plastic expansion particle) and then fill the plastic expansion particles in the holes.

(3) Fix the wall-mounting frame on the wall with tapping screws and then check if the frame is firmly installed by pulling the frame. If the plastic expansion particle is loose, please drill another fixing hole nearby.

### 3. Drill Piping Hole

(1) Choose the position of piping hole according to the direction of outlet pipe. The position of piping hole should be a little lower than the wall-mounted frame. (As show in Fig.1)

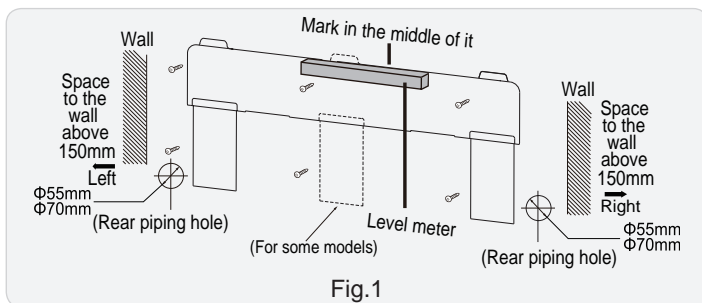

(2) Drill a piping hole with the diameter of  $\Phi 55\text{mm}$  or  $\Phi 70\text{mm}$  on the selected outlet pipe position. In order to drain smoothly, slant the piping hole on the wall slightly downward to the outdoor side with the gradient of  $5\text{-}10^\circ$ . (As show in Fig.2)

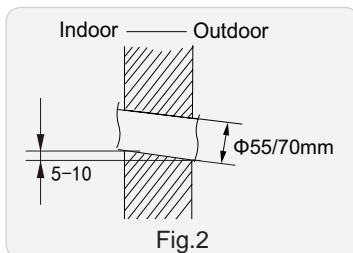

### ⚠ Note:

Pay attention to dust prevention and take relevant safety measures when opening the hole.

### 4. Outlet Pipe

(1) The pipe can be led out in the direction of right, rear right, left or rear left. (As show in Fig.3)

(2) When selecting leading out the pipe from left or right, please cut off the corresponding hole on the bottom case. (As show in Fig.4)

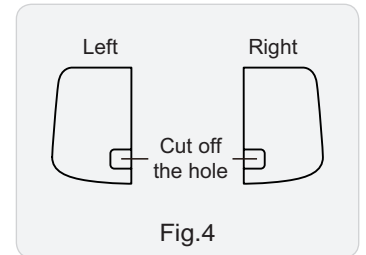
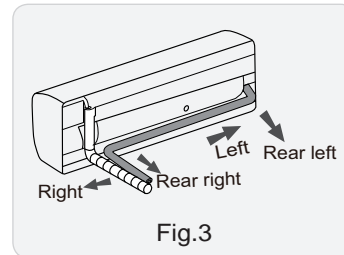

### 5. Connect the Pipe of Indoor Unit

(1) Aim the pipe joint at the corresponding bellmouth. (As show in Fig.5)

(2) Pretightening the union nut with hand.

(3) Adjust the torque force by referring to the following sheet. Place the open-end wrench on the pipe joint and place the torque wrench on the union nut. Tighten the union nut with torque wrench. (As show in Fig.6)

(4) Wrap the indoor pipe and joint of connection pipe with insulating pipe, and then wrap it with tape. (As show in Fig.7)

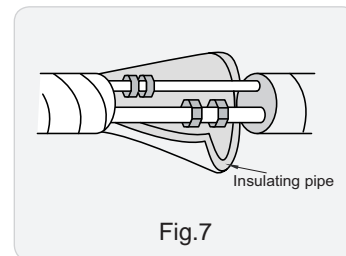
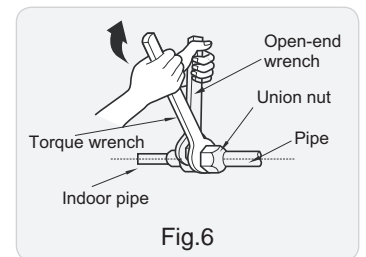
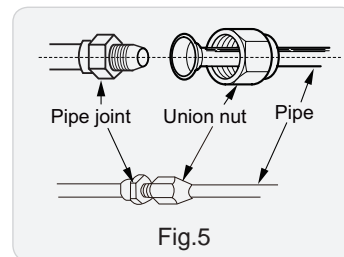

Refer to the following table for wrench moment of force:

Piping size	Tightening torque(N·m)
1/4"	15~20
3/8"	30~40
1/2"	45~55
5/8"	60~65
3/4"	70~75



## 6. Install Drain Hose

(1) Connect the drain hose to the outlet pipe of indoor unit.(As show in Fig.8)

(2) Bind the joint with tape.(As show in Fig.9)

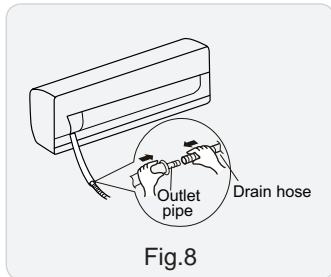

Fig.8

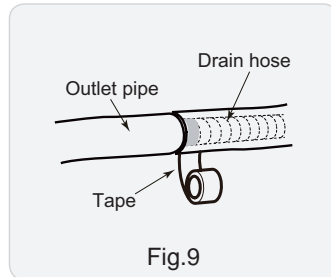

Fig.9

### ⚠ Note:

(1) Add insulating pipe in the indoor drain hose in order to prevent condensation.

(2) The plastic expansion particles are not provided.  
(As show in Fig.10)

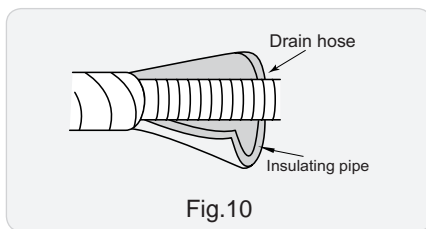

Fig.10

## 7. Connect Wire of Indoor Unit

(1) Open the panel, remove the screw on the wiring cover and then take down the cover.(As show in Fig.11)

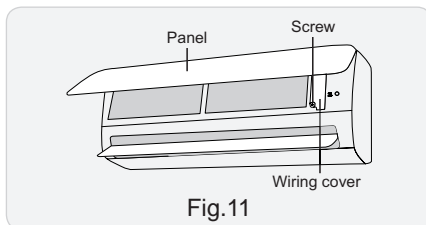

Fig.11

(2) Make the power connection wire go through the cable-cross hole at the back of indoor unit and then pull it out from the front side.(As show in Fig.12)

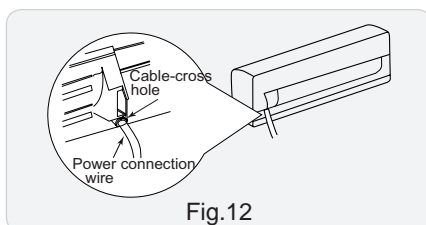

Fig.12

(3) Remove the wire clip; connect the power connection wire signal control wire (only for cooling and heating unit) to the wiring terminal according to the color; tighten the screw and then fix the power connection wire with wire clip.(As show in Fig.13)

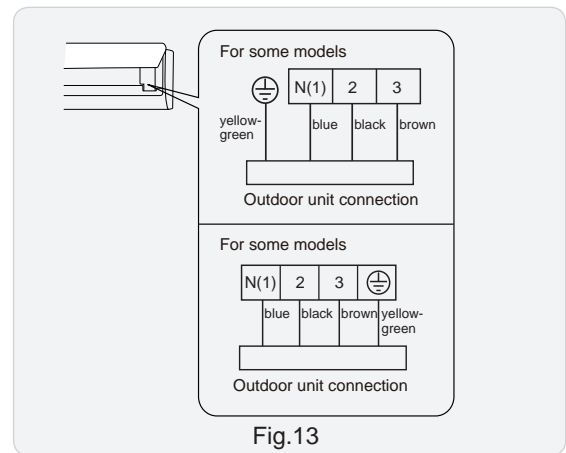

Fig.13

Note: The wiring connect is for reference only, please refer to the actual one.

(4) Put wiring cover back and then tighten the screw.

(5) Close the panel.

### ⚠ Note:

(1) All wires of indoor unit and outdoor unit should be connected by a professional.

(2) If the length of power connection wire is insufficient, please contact the supplier for a new one. Avoid extending the wire by yourself.

(3) For the air conditioner with plug, the plug should be reachable after finishing installation.

(4) For the air conditioner without plug, an air switch must be installed in the line. The air switch should be all-pole parting and the contact parting distance should be more than 3mm.

## 8. Bind up Pipe

(1) Bind up the connection pipe, power cord and drain hose with the band.(As show in Fig.14)

(2) Reserve a certain length of drain hose and power cord for installation when binding them. When binding to a certain degree, separate the indoor power and then separate the drain hose.(As show in Fig.15)

(3) Bind them evenly.

(4) The liquid pipe and gas pipe should be bound separately at the end.

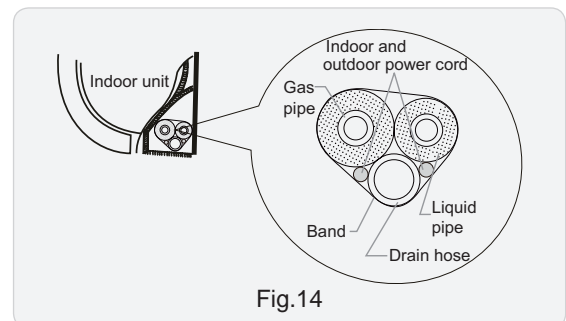

Fig.14

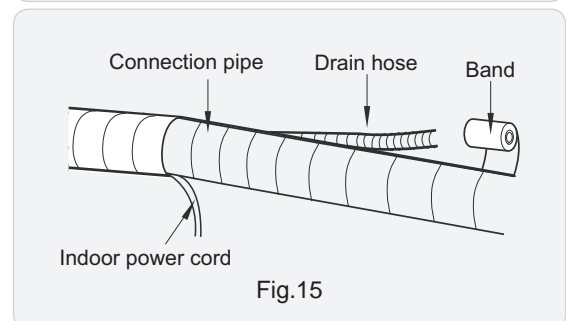

Fig.15

**⚠ Note:**

- (1) The power cord and control wire Can't be crossed or winding.
- (2) The drain hose should be bound at the bottom.

**9. Hang the Indoor Unit**

- (1) Put the bound pipes in the wall pipe and then make them pass through the wall hole.
- (2) Hang the indoor unit on the wall-mounting frame.
- (3) Stuff the gap between pipes and wall hole with sealing gum.
- (4) Fix the wall pipe.(As show in Fig.16)
- (5) Check if the indoor unit is installed firmly and closed to the wall.(As show in Fig.17)

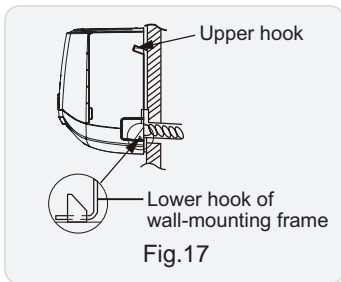
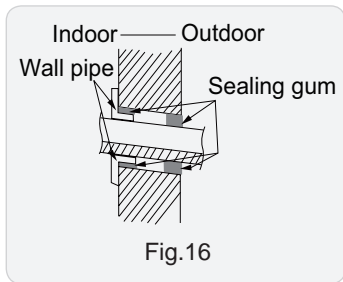

**⚠ Note:**

Do not bend the drain hose too excessively in order to prevent blocking.

**8.6 Installation of Outdoor unit**

**1. Fix the Support of Outdoor Unit(Select it according to the actual installation situation)**

- (1) Select installation location according to the house structure.
- (2) Fix the support of outdoor unit on the selected location with expansion screws.

**⚠ Note:**

- (1) Take sufficient protective measures when installing the outdoor unit.
- (2) Make sure the support can withstand at least four times the unit weight.
- (3) The outdoor unit should be installed at least 3cm above the floor in order to install drain joint.(As show in Fig.18)
- (4) For the unit with cooling capacity of 2300W~5000W, 6 expansion screws are needed; for the unit with cooling capacity of 6000W~8000W, 8 expansion screws are needed; for the unit with cooling capacity of 10000W~16000W, 10 expansion screws are needed.

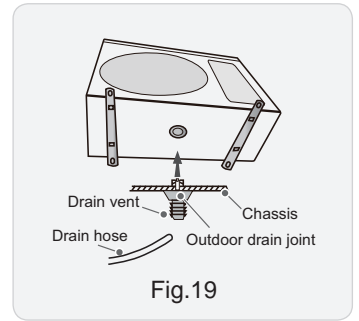
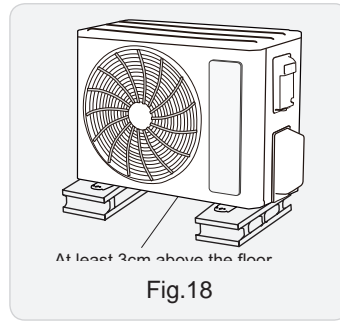

**2. Install Drain Joint(Only for cooling and heating unit)**

- (1) Connect the outdoor drain joint into the hole on the chassis.
  - (2) Connect the drain hose into the drain vent.
- (As show in Fig.19)

**3. Fix Outdoor Unit**

- (1) Place the outdoor unit on the support.
  - (2) Fix the foot holes of outdoor unit with bolts.
- (As show in Fig.20)

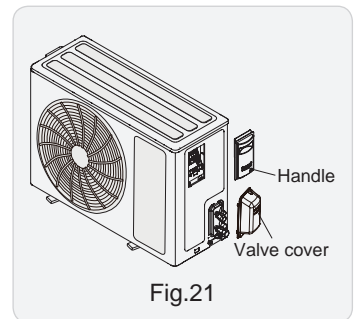
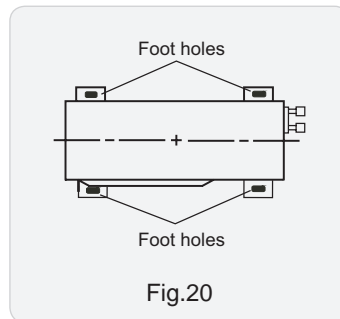

**4. Connect Indoor and Outdoor Pipes**

- (1) Remove the screws on the big handle and valve cover of outdoor unit, then remove them.(As show in Fig.21)
- (2) Remove the screw cap of valve and aim the pipe joint at the bellmouth of pipe.(As show in Fig.22)

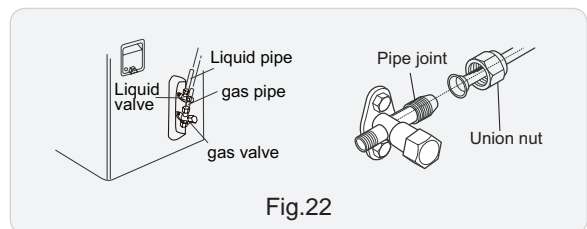

- (3) Pretightening the union nut with hand.
- (4) Tighten the union nut with torque wrench .

Refer to the following table for wrench moment of force:

Piping size	Tightening torque(N·m)
1/4"	15~20
3/8"	30~40
1/2"	45~55
5/8"	60~65
3/4"	70~75

## 5. Connect Outdoor Electric Wire

(1) Remove the wire clip; connect the power connection wire and signal control wire (only for cooling and heating unit) to the wiring terminal according to the color; fix them with screws.(As show in Fig.23)

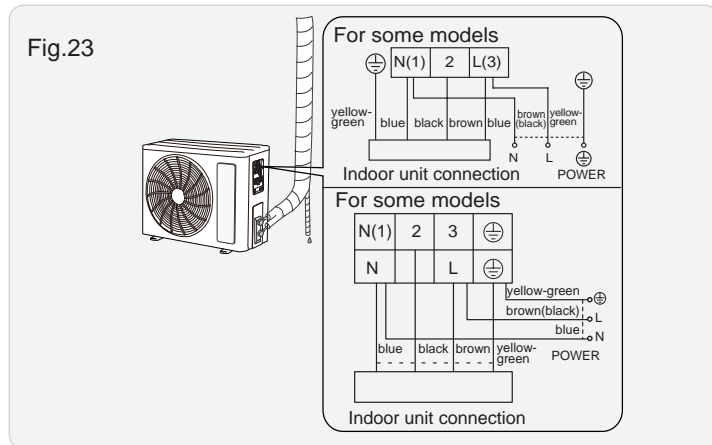

Note: the wiring connect is for reference only, please refer to the actual one.

(2) Fix the power connection wire and signal control wire with wire clip (only for cooling and heating unit).

### ⚠ Note:

- (1) After tightening the screw, pull the power cord slightly to check if it is firm.
- (2) Never cut the power connection wire to prolong or shorten the distance.

## 6. Neaten the Pipes

- (1) The pipes should be placed along the wall, bent reasonably and hidden possibly. Min. semidiameter of bending the pipe is 10cm.
- (2) If the outdoor unit is higher than the wall hole, you must set a U-shaped curve in the pipe before pipe goes into the room, in order to prevent rain from getting into the room.(As show in Fig.24)

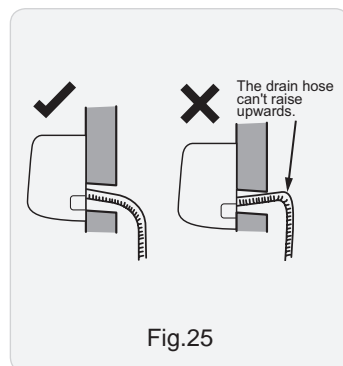
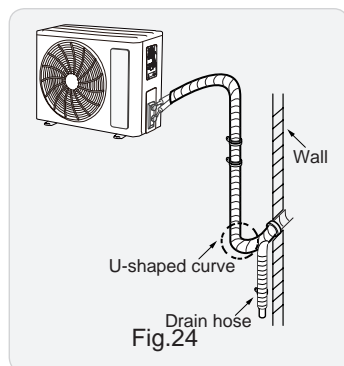

### ⚠ Note:

- (1) The through-wall height of drain hose shouldnt be higher than the outlet pipe hole of indoor unit.(As show in Fig.25)
- (2) Slant the drain hose slightly downwards. The drain hose Can't be curved, raised and fluctuant, etc.(As show in Fig.26)
- (3) The water outlet Can't be placed in water in order to drain smoothly.(As show in Fig.27)

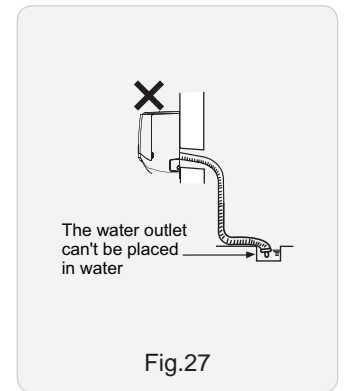
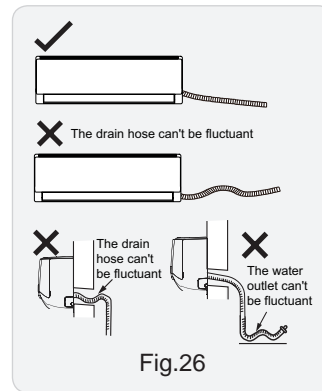

## 8.7 Vacuum Pumping and Leak Detection

### 1. Use Vacuum Pump

- (1) Remove the valve caps on the liquid valve and gas valve and the nut of refrigerant charging vent.
- (2) Connect the charging hose of piezometer to the refrigerant charging vent of gas valve and then connect the other charging hose to the vacuum pump.
- (3) Open the piezometer completely and operate for 10-15min to check if the pressure of piezometer remains in -0.1MPa.
- (4) Close the vacuum pump and maintain this status for 1-2min to check if the pressure of piezometer remains in -0.1MPa. If the pressure decreases, there may be leakage.
- (5) Remove the piezometer, open the valve core of liquid valve and gas valve completely with inner hexagon spanner.
- (6) Tighten the screw caps of valves and refrigerant charging vent.(As show in Fig.28)

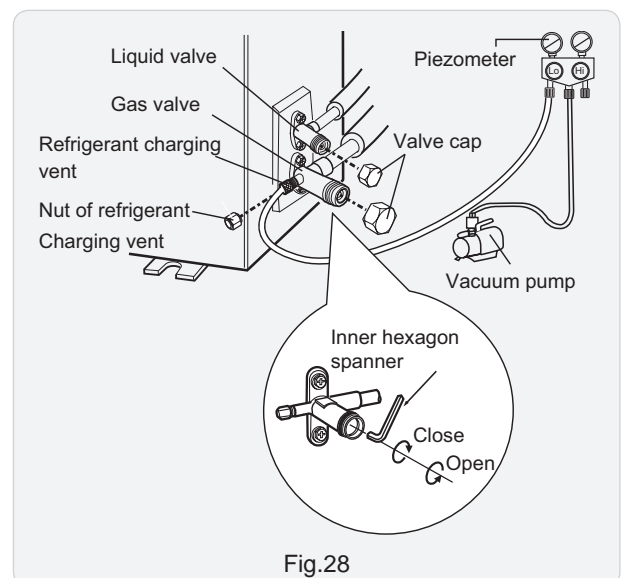

### 2. Leakage Detection

- (1) With leakage detector: Check if there is leakage with leakage detector.
- (2) With soap water: If leakage detector is not available, please use soap water for leakage detection. Apply soap water at the suspected position and keep the soap water for more than 3min. If there are air bubbles coming out of this position, there's a leakage.

## 8.8 Check after Installation and Test Operation

### 1. Check after Installation

Check according to the following requirement after finishing installation.

NO.	Items to be checked	Possible malfunction
1	Has the unit been installed firmly?	The unit may drop, shake or emit noise.
2	Have you done the refrigerant leakage test?	It may cause insufficient cooling (heating) capacity.
3	Is heat insulation of pipeline sufficient?	It may cause condensation and water dripping.
4	Is water drained well?	It may cause condensation and water dripping.
5	Is the voltage of power supply according to the voltage marked on the nameplate?	It may cause malfunction or damage the parts.
6	Is electric wiring and pipeline installed correctly?	It may cause malfunction or damage the parts.
7	Is the unit grounded securely?	It may cause electric leakage.
8	Does the power cord follow the specification?	It may cause malfunction or damage the parts.
9	Is there any obstruction in air inlet and air outlet?	It may cause insufficient cooling (heating) capacity.
10	The dust and sundries caused during installation are removed?	It may cause malfunction or damaging the parts.
11	The gas valve and liquid valve of connection pipe are open completely?	It may cause insufficient cooling (heating) capacity.
12	Is the inlet and outlet of piping hole been covered?	It may cause insufficient cooling(heating) capacity or waster eletricity.

### 2. Test Operation

(1) Preparation of test operation

- The client approves the air conditioner installation.
- Specify the important notes for air conditioner to the client.

(2) Method of test operation

- Put through the power, press ON/OFF button on the remote controller to start operation.
- Press MODE button to select AUTO, COOL, DRY, FAN and HEAT to check whether the operation is normal or not.
- If the ambient temperature is lower than 16°C, the air conditioner Can't start cooling.

# 9. Maintenance

## 9.1 Error Code List

Error code	Malfunction name	AC status	Possible causes
<b>C5</b>	Malfunction of jumper cap	The complete unit stops operation	<ol style="list-style-type: none"> <li>1. Jumper cap is not installed in control panel;</li> <li>2. Poor contact of jumper cap;</li> <li>3. Jumper cap is damaged;</li> <li>4. The tested circuit of jumper cap on control panel is abnormal.</li> </ol>
<b>E6</b>	Communication malfunction between indoor unit and outdoor unit	Cool: compressor stops operation, while indoor fan operates; Heat: all loads stops operation.	See "Communication malfunction"
<b>H5</b>	IPM protection	Cool/Dry: compressor stops operation, while indoor fan operates. Heat: all loads stops operation.	See "IPM protection, over-phase current of compressor"
<b>L3 LA</b>	Malfunction of outdoor fan/ malfunction of DC motor	Cool/Dry: all loads stops operation except indoor fan. Heat: all loads stops operation.	<ol style="list-style-type: none"> <li>1. Outdoor condenser, air inlet and air outlet are blocked by filth or dirt;</li> <li>2. Fan is blocked or loosened;</li> <li>3. Motor or connection wire of motor is damaged;</li> <li>4. Main board of outdoor unit is damaged;</li> </ol> (As for dual-outdoor fan, L3 indicates fan 1; LA indicates fan 2)
<b>H3</b>	Overload protection of compressor	Cool/Dry: compressor stops operation, while indoor fan operates. Heat: all loads stops operation.	<ol style="list-style-type: none"> <li>1. Overload wire of compressor is loose;</li> <li>2. The overload protector is damaged. Under normal circumstances, the resistance between both ends of terminal is less than 1ohm.</li> <li>3. See "Overload protection of compressor , High discharge temperature protection of compressor"</li> </ol>
<b>F0</b>	Refrigerant insufficient protection, cut-off protection of refrigerant	Cool: compressor and outdoor fan stops operation, while indoor fan operates; Heat: Compressor, outdoor fan and indoor fan stops operation.	<ol style="list-style-type: none"> <li>1. Is system cooling under high humidity environment, thus temperature difference of heat transfer is small;</li> <li>2. Check whether the big valve and small valve of outdoor unit are opened completely;</li> <li>3. Is the temperature sensor of evaporator of indoor unit loose?</li> <li>4. Is the temperature sensor of condenser of outdoor unit loose?</li> <li>5. Is the capillary or the electronic expansion valve blocked?</li> <li>6. Is refrigerant leaking?</li> </ol>
<b>F1</b>	Indoor ambient temperature sensor is open/short-circuited	Cool/Dry: indoor fan operates, while compressor and outdoor fan stops operation; Heat: all loads stops operation.	<ol style="list-style-type: none"> <li>1. Temperature sensor is not well connected;</li> <li>2. Temperature sensor is damaged</li> <li>3. Main board of indoor unit is damaged.</li> </ol>
<b>F2</b>	Indoor evaporator temperature sensor is open/short-circuited	Cool/Dry: indoor fan operates, while compressor and outdoor fan stops operation; Heat: all loads stops operation.	<ol style="list-style-type: none"> <li>1. Temperature sensor is not well connected;</li> <li>2. Temperature sensor is damaged</li> <li>3. Main board of indoor unit is damaged.</li> </ol>
<b>H6</b>	No feedback from indoor unit's motor	The complete unit stops operation	<ol style="list-style-type: none"> <li>1. Is the fan blocked?</li> <li>2. Is the motor terminal loose?</li> <li>3. Is the connection wire of motor damaged?</li> <li>4. Is the motor damaged?</li> <li>5. Is the main board of indoor unit damaged?</li> </ol>
<b>LP</b>	Indoor unit and outdoor can be matched with each other	Heat: compressor, outdoor unit and indoor fan stops operation.	Capacity of indoor unit and outdoor unit can't be matched.
<b>C4</b>	Malfunction of jumper cap of outdoor unit	Heat: all loads are stopped; other modes: outdoor unit stops operation.	Jumper cap of outdoor unit hasn't been installed.
<b>b7</b>	Gas valve temperature sensor is ON / short-circuited		<ol style="list-style-type: none"> <li>1. Temperature sensor is not well connected or damaged;</li> <li>2. The wire of temperature sensor is damaged, causing short circuit to copper pipe or outer casing;</li> <li>3. Main board of outdoor unit is damaged.</li> </ol>

Error code	Malfunction name	AC status	Possible causes
<b>b5</b>	Liquid valve temperature sensor is ON / short-circuited		<ol style="list-style-type: none"> <li>1. Temperature sensor is not well connected or damaged;</li> <li>2. The wire of temperature sensor is damaged, causing short circuit to copper pipe or outer casing;</li> <li>3. Main board of outdoor unit is damaged.</li> </ol>
<b>E1</b>	High pressure protection of system	Cool/Dry: all loads stops operation except indoor fan; Heat: all loads stops operation.	<ol style="list-style-type: none"> <li>1. Heat exchange of outdoor unit is too dirty, or it blocked the air inlet/outlet;</li> <li>2. Is power voltage normal; (three-phase unit)</li> <li>3. Ambient temperature is too high;</li> <li>4. Wiring of high pressure switch is loose or high pressure switch is damaged;</li> <li>5. The internal system is blocked; (dirt blockage, ice blockage, oil blockage, angle valve is not completely opened)</li> <li>6. Main board of outdoor unit is damaged;</li> <li>7. Refrigerant is too much.</li> </ol>
<b>E3</b>	Low pressure/low system pressure protection/ compressor low pressure protection	Cool: compressor, outdoor fan and indoor fan stop operation; Heat: compressor and outdoor fan stop operation at first. About 1 minute later, indoor fan stops operation; 2 minutes later, the 4-way valve stop operation.	<ol style="list-style-type: none"> <li>1. Low pressure switch is damaged;</li> <li>2. Refrigerant inside the system is insufficient.</li> </ol>
<b>E4</b>	High discharge temperature protection of compressor	Cool/Dry: compressor and outdoor fan stops operation, while indoor fan operates; Heat: all loads stops operation.	See "Overload protection of compressor , High discharge temperature protection of compressor"
<b>E5</b>	AC overcurrent protection	Cool/Dry: compressor and outdoor fan stops operation, while indoor fan operates; Heat: all loads stops operation.	<ol style="list-style-type: none"> <li>1. Power voltage is unstable;</li> <li>2. Power voltage is too low;</li> <li>3. System load is too high, which leads to high current;</li> <li>4. Heat exchange of indoor unit is too dirty, or it blocked the air inlet/outlet;</li> <li>5. Fan motor operation is abnormal; the fan speed is too low or not functioning;</li> <li>6. Compressor is blocked;</li> <li>7. The internal system is blocked; (dirt blockage, ice blockage, oil blockage, angle valve is not completely opened)</li> <li>8. Main board of outdoor unit is damaged.</li> </ol> See "AC overcurrent protection"
<b>E7</b>	Mode shock/sysmte mode shock	Load of indoor unit stops operation (indoor fan, E-heater, swing)	Malfunction of one-to-more system; there may be two indoor units which has set the shock mode, such as one is cooling and the other is heating.
<b>E8</b>	High temperature prevention protection	Cool: compressor stops operation while indoor fan operates; Heat: all loads stops operation.	See "High temperature prevention protection; high power; system isabnormal"
<b>EE</b>	Malfunction of EEPROM	Cool/Dry: compressor stops operation, while indoor fan operates; Heat: all loads stops operation.	Main board of outdoor unit is damaged.
<b>F0</b>	Refrigerant-recovery mode	Cool/Dry: compressor and outdoor fan stops operation, while indoor fan operates.	Refrigerant recovery. The maintenance personnel operate it when he is maintaining the unit.
<b>F3</b>	Outdoor ambient temperature is open/short-circuited	Cool/Dry: compressor and outdoor fan stop operation, while indoor fan operates; Heat: all loads stops operation.	<ol style="list-style-type: none"> <li>1. Temperature sensor is not connected well or damaged;</li> <li>2. Temperature sensor wire of outdoor unit is damaged; short circuit between the temperature sensor and copper pipe or outer case;</li> <li>3. Main board of outdoor unit is damaged;</li> </ol>



Error code	Malfunction name	AC status	Possible causes
F4	Outdoor condenser temperature sensor is open/short-circuited	Cool/Dry: compressor and outdoor fan stop operation, while indoor fan operates; Heat: after operating for 3 minutes, all loads stops operation.	1. Temperature sensor is not connected well or damaged; 2. Temperature sensor wire of outdoor unit is damaged; short circuit between the temperature sensor and copper pipe or outer case; 3. Main board of outdoor unit is damaged.
F5	Outdoor air discharge temperature is open/short-circuited	Complete unit stops operation; motor of sliding door is cut off power.	1. The exhaust temperature sensor is not connected well or damaged. 2. Temperature sensor wire of outdoor unit is damaged; short circuit between the temperature sensor and copper pipe or outer case 3. Main board of outdoor unit is damaged;
FC	Malfunction of micro switch	Cool/Dry: compressor stops operation, while indoor fan operates; Heat: all loads stops operation.	1. The sliding door is blocked; 2. Malfunction of the photoelectric inspection panel of sliding door;
H4	System is abnormal	Cool/Dry: all loads stops operation except indoor fan; Heat: all loads stops operation.	See "High temperature prevention protection; high power; system is abnormal"
H7	Desynchronizing of compressor	Cool/Dry: compressor stops operation, while indoor fan operates; Heat: all loads stops operation.	See "Desynchronization diagnosis for compressor"
HC	PFC protection	Cool/Dry: compressor stops operation, while indoor fan operates; Heat: all loads stops operation.	1. The power grid quality is bad; AC input voltage fluctuates sharply; 2. Power plug of air conditioner or wiring board or reactor is not connected reliably; 3. Indoor and outdoor heat exchanger is too dirty, or air inlet/outlet is blocked; 4. Main board of outdoor unit is damaged.
HE	Demagnetization protection of compressor	Cool: compressor and outdoor fan stop operation; Heat: compressor and outdoor fan stop operation at first; about 1 minute later, indoor fan stops operation.	1. The main board of outdoor unit is damaged; 2. Compressor is damaged;
UF	Communication malfunction between indoor unit and inspection board	Normal operation	1. Poor connection between the indoor unit and the inspection board. 2. The main board of indoor unit is damaged; 3. The inspection board is damaged;
L1	Malfunction of humidity sensor	Compressor, outdoor fan and indoor fan stop operation;	The inspection board is damaged.
L9	High power protection	Cool: compressor and outdoor fan stops operation, while indoor fan operates.	See "High temperature prevention protection; high power; system is abnormal"
Lc	Start-up failed	Cool/Dry: compressor stops, while indoor fan operates; Heat: all loads stops operation.	See "Malfunction diagnosis for failure startup"
Ld	Lost phase	Cool: compressor and outdoor fan stop operation; Heat: compressor and outdoor fan stop operation at first; about 1 minute later, indoor fan stops operation.	1. The main board of outdoor unit is damaged; 2. The compressor is damaged; 3. The connection wire of compressor is not connected well.
PS	Over-phase current protection of compressor	Cool/Dry: compressor stops operation, while indoor fan operates; Heat: all loads stops operation.	See "Overload protection of compressor , High discharge temperature protection of compressor"



Error code	Malfunction name	AC status	Possible causes
<b>oE</b>	Undefined outdoor unit error	Cool: compressor and outdoor fan stops operation, while indoor fan operates; Heat: compressor, outdoor fan and indoor fan stop operation.	<ol style="list-style-type: none"> <li>1. Outdoor ambient temperature exceeds the operation range of unit (e.g.: less than 20°C or more than 60°C for cooling; more than 30°C for heating);</li> <li>2. Are wires of compressor not connected tightly?</li> <li>3. Failure startup of compressor?</li> <li>4. Is compressor damaged?</li> <li>5. Is main board damaged?</li> </ol>
<b>P6</b>	Communication malfunction between the drive board and the main board	Cool: compressor and outdoor fan stops operation; Heat: compressor and outdoor fan stop at first; about 1 minute later, indoor fan stops operation;	<ol style="list-style-type: none"> <li>1. The drive board is damaged;</li> <li>2. The main board of outdoor unit is damaged;</li> <li>3. The drive board and the main board is not connected well.</li> </ol>
<b>P7</b>	Circuit malfunction of module temperature sensor	Cool/Dry: compressor stops operation, while indoor fan operates; Heat: all loads stops operation.	Replace outdoor control board
<b>P8</b>	Module overheating protection	Cool: compressor stops operation, while indoor fan operates; Heat: all loads stops operation.	<ol style="list-style-type: none"> <li>1. Air inlet / air outlet of outdoor unit are blocked by filth or dirt;</li> <li>2. Condenser of outdoor unit is blocked by filth or dirt;</li> <li>3. IPM screw of main board is not tightened;</li> <li>4. Main board of outdoor unit is damaged;</li> </ol>
<b>PF</b>	Malfunction of ambient temperature sensor of drive board	Cool: compressor, outdoor fan and indoor fan stop operation; Heat: compressor and outdoor fan stop operation at first; about 1 minute later, indoor fan stops operation.	<ol style="list-style-type: none"> <li>1. The ambient temperature sensor of the drive board is not connected well;</li> <li>2. Malfunction of the ambient temperature sensor of drive board.</li> </ol>
<b>PH</b>	DC bus voltage is too high	Cool/Dry: compressor stops operation, while indoor fan operates; Heat: all loads stops operation.	<ol style="list-style-type: none"> <li>1. Measure the voltage between position L and position N on the wiring board (XT). If it's higher than 265 VAC, please turn on the unit until the power voltage is decreased to the normal range;</li> <li>2. If the AC input is normal, please replace the outdoor control board.</li> </ol>
<b>PL</b>	DC bus voltage is too low	Cool/Dry: compressor stops operation, while indoor fan operates; Heat: all loads stops operation.	<ol style="list-style-type: none"> <li>1. Measure the voltage between position L and position N on the wiring board (XT). If it's lower than 150 VAC, please turn on the unit until the power voltage is increased to the normal range;</li> <li>2. If the AC input is normal, please replace the outdoor control board.</li> </ol>
<b>PU</b>	Charging malfunction of capacitor	Cool/Dry: compressor stops operation, while indoor fan operates; Heat: all loads stops operation.	See "Charging malfunction of capacitor"
<b>rF</b>	Malfunction of RF module	Cool: compressor and outdoor fan stop operation; Heat: compressor and outdoor fan stop operation at first; about 1 minute later, indoor fan stops operation.	<ol style="list-style-type: none"> <li>1. The connection wire of RF module is not connected well.</li> <li>2. Malfunction of RF module;</li> </ol>
<b>U1</b>	Phase current detection circuit malfunction of	Cool: compressor and outdoor fan stops operation, while indoor fan operates; Heat: compressor, outdoor fan and indoor fan stops operation.	The control board is damaged
<b>U2</b>	Lost phase protection of compressor	Cool: compressor and outdoor fan stop operation; Heat: compressor and outdoor fan stop operation at first; about 1 minute later, indoor fan stops operation.	<ol style="list-style-type: none"> <li>1. The main board of outdoor unit is damaged;</li> <li>2. The compressor is damaged;</li> <li>3. The connection wire of compressor is not connected well.</li> </ol>

Error code	Malfunction name	AC status	Possible causes
U3	DC bus voltage drop malfunction	Cool/Dry: compressor stops operation, while indoor fan operates; Heat: all loads stops operation.	The power voltage is unstable.
U5	Current detection malfunction of unit	Cool: compressor and outdoor fan stops operation, while indoor fan operates; Heat: compressor, outdoor fan and indoor fan stops operation.	1. Is the complete unit lacking of refrigerant? 2. There's malfunction for the circuit of control board of outdoor unit. Replace the control board of outdoor unit.
U7	4-way valve is abnormal	This malfunction occurs when the unit is heating. All loads stops operation.	1. Power voltage is lower than AC175V; 2. Wiring terminal of 4-way valve is loose or broken; 3. 4-way valve is damaged. Replace the 4-way valve.
U8	Malfunction of zero-crossing signal of indoor unit	Compressor, outdoor fan and indoor fan stop operation.	1. The power is abnormal; 2. Main board of indoor unit is damaged.
U9	Zero-crossing malfunction of outdoor unit	Cool: compressor stops operation, while indoor fan operates; Heat: all loads stops operation.	Replace the control board of outdoor unit.
E2	Evaporator anti-freezing protection		Not error code, it is the status code in cooling process
E9	Anti cold air protection		Not error code, it is the status code in cooling process
	Defrosting	Heat indicator Flash once/10s	Not error code, it is the status code in cooling process

## Analysis or processing of some of the malfunction display:

### 1. Compressor discharge protection

Possible causes: shortage of refrigerant; blockage of air filter; poor ventilation or air flow short pass for condenser; the system has noncondensing gas (such as air, water etc.); Blockage of capillary assy (including filter); leakage inside four-way valve causes incorrect operation; malfunction of compressor; malfunction of protection relay; malfunction of discharge sensor; outdoor temperature too high.

Processing method: refer to the malfunction analysis in the above section.

### 2. Low voltage overcurrent protection

Possible cause: Sudden drop of supply voltage.

### 3. Communication malfunction

Processing method: Check if communication signal cable is connected reliably.

### 4. Sensor open or short circuit

Processing method: Check whether sensor is normal, connected with the corresponding position on the controller and if damage of lead wire is found.

### 5. Compressor over load protection

Possible causes: insufficient or too much refrigerant; blockage of capillary and increase of suction temp.; improper running of compressor, burning in or stuck of bearing, damage of discharge valve; malfunction of protector.

Processing method: adjust refrigerant amount; replace the capillary; replace the compressor; use universal meter to check if the contactor of compress or is fine when it is not overheated, if not replace the protector.

### 6. System malfunction

i.e. overload protection. When tube temperature(Check the temperature of outdoor heat exchanger when cooling and check the temperature of indoor heat exchanger when heating) is too high, protection will be activated.

Possible causes: Outdoor temperature is too high when cooling; insufficient outdoor air circulation; refrigerant flow malfunction.

Please refer to the malfunction analysis in the previous section for handling method .

### 7. IPM module protection

Processing method: Once the module malfunction happens, if it persists for a long time and can not be self-canceled, cut off the power and turn off the unit, and then re-energize the unit again after about 10 min. After repeating the procedure for sever times, if the malfunction still exists, replace the module.

If malfunction occurs, corresponding code will display and the unit will resume normal until protection or malfunction disappears.

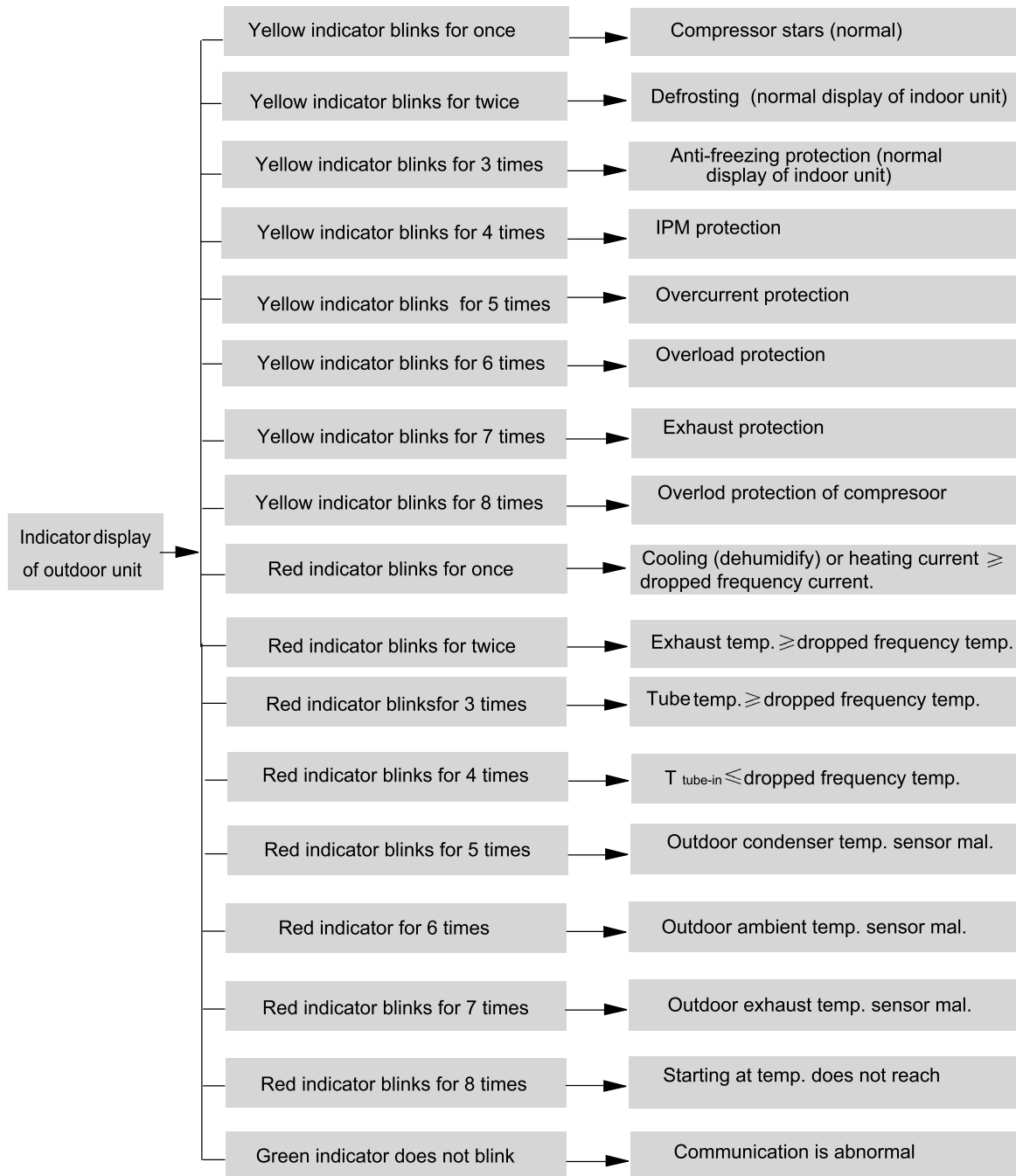

## 9.2 Procedure of Troubleshooting

### 1. Troubleshooting for jumper cap ⚡

Main check points:

- (1) jumper cap
- (2) control board of indoor unit

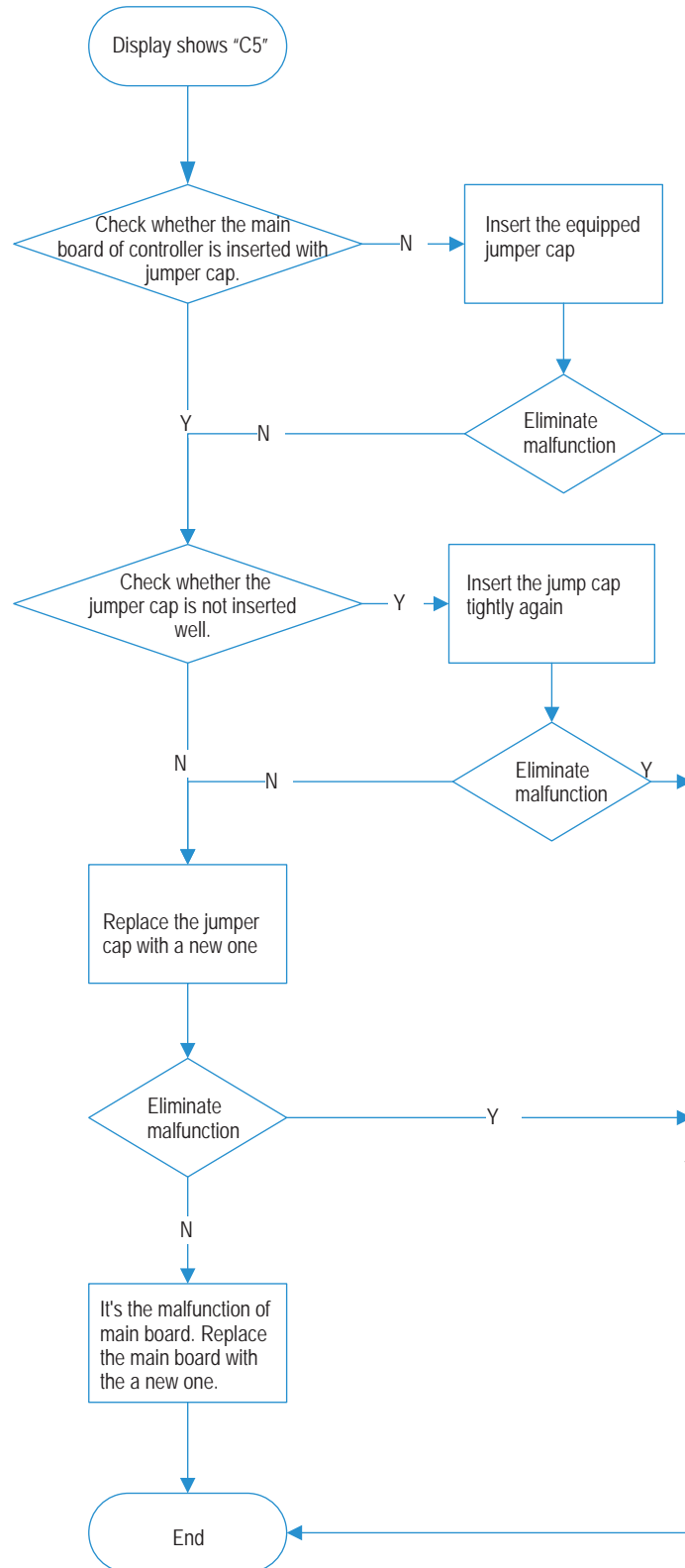

## 2. Communication malfunction E5

Main check points:

- (1) Connection wire between indoor unit and outdoor unit
- (2) Wiring inside the unit
- (3) Communication circuit of control board of indoor unit
- (4) Communication circuit of control board of outdoor unit

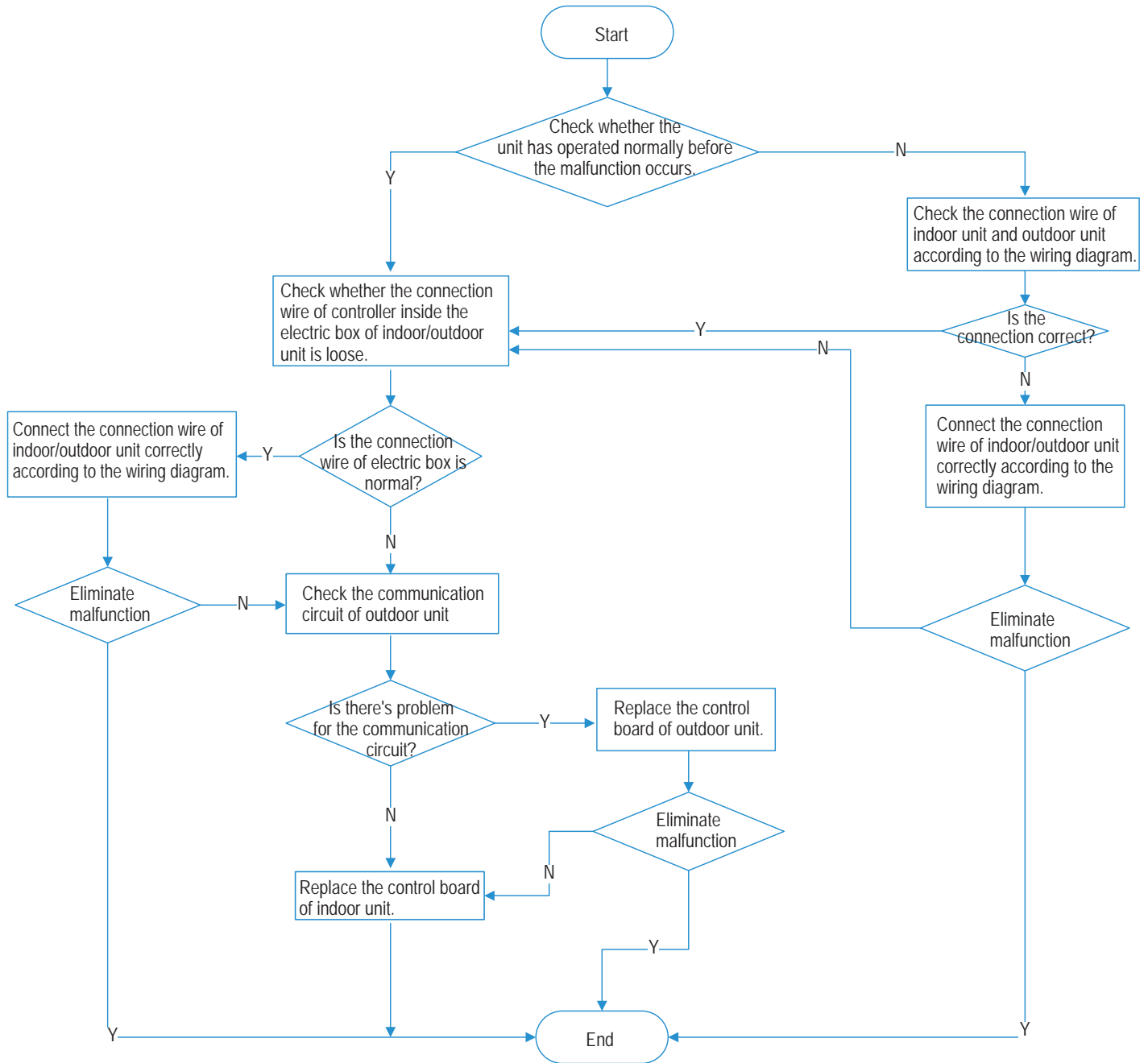

### 3. IPM protection H5, over-phase current of compressor P5

Main check points:

- (1) compressor COMP terminal (2) power supply voltage (3) compressor  
 (4) charging amount of refrigerant (5) air inlet and air outlet of indoor/outdoor unit

NOTE: The control board as below means the control board of outdoor unit.

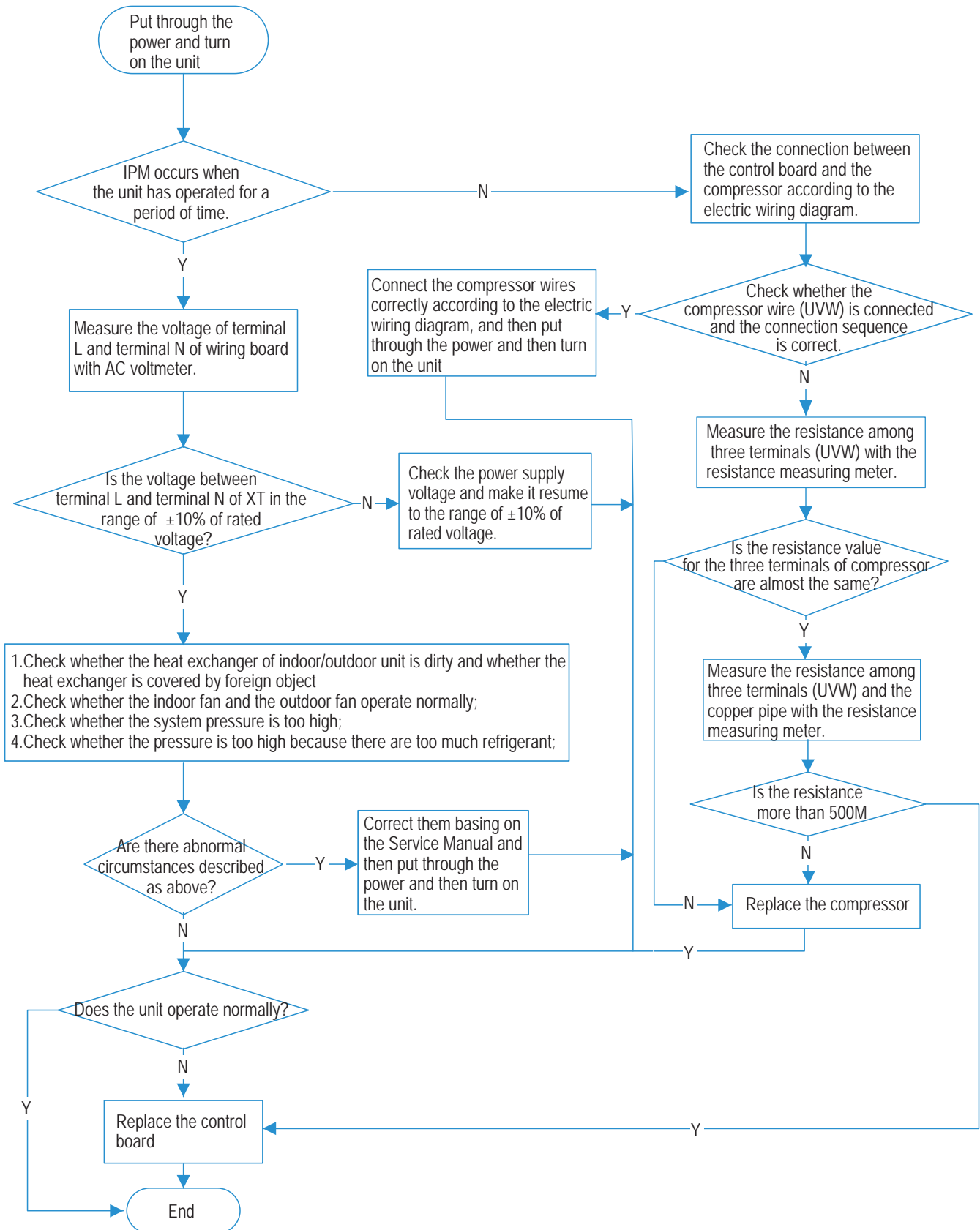

#### 4. Overload protection of compressor H3, high discharge temperature, protection of compressor E4

Main check points:

- (1) electronic expansion valve      (2) expansion valve terminal
- (3) charging amount of refrigerant    (4) overload protector

NOTE: The control board as below means the control board of outdoor unit.

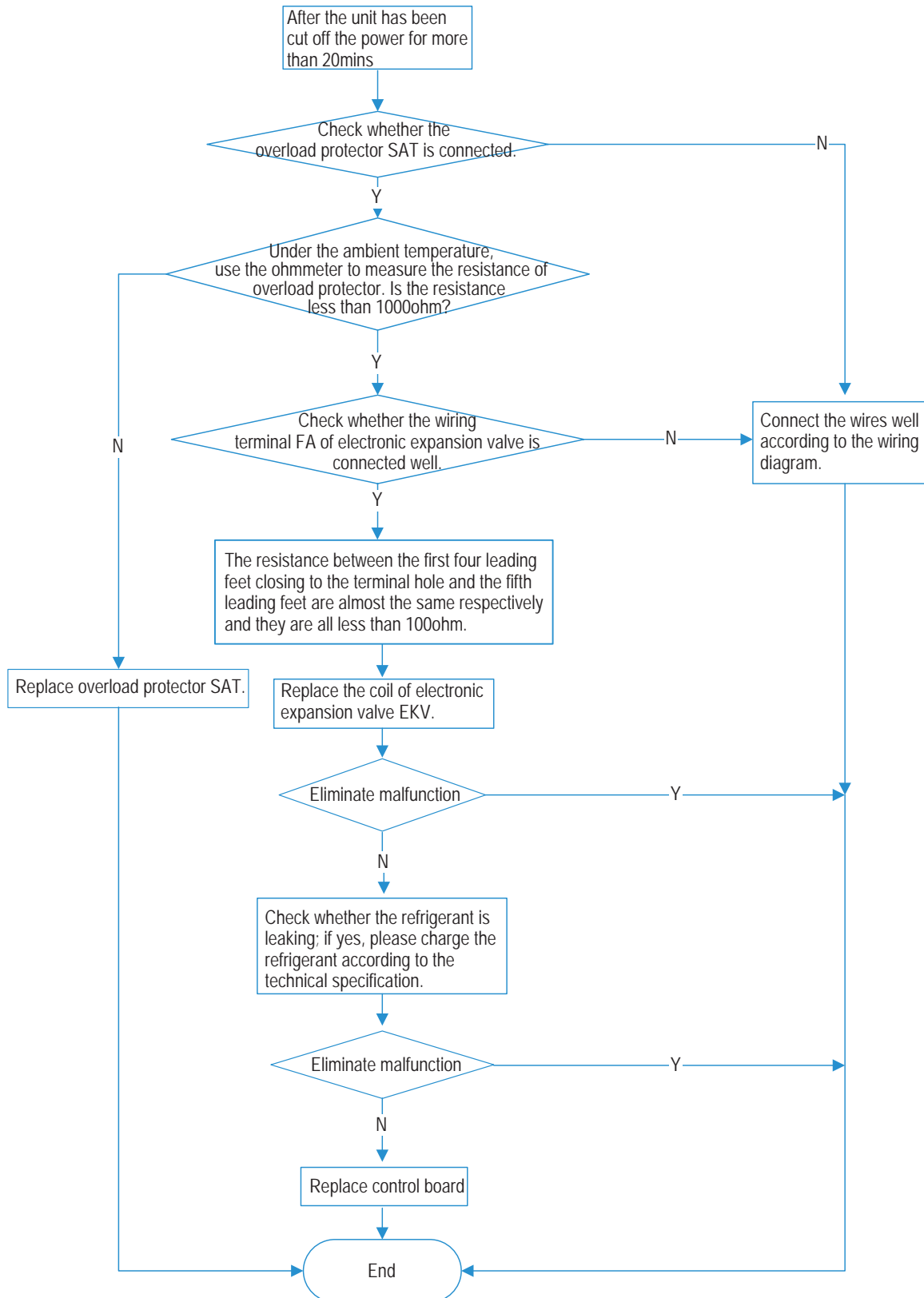



## 5. Troubleshooting for temperature sensor F 1,F2,F3,F4,F5

Main check points:

(1) connection terminal (2) temperature sensor (3) main board

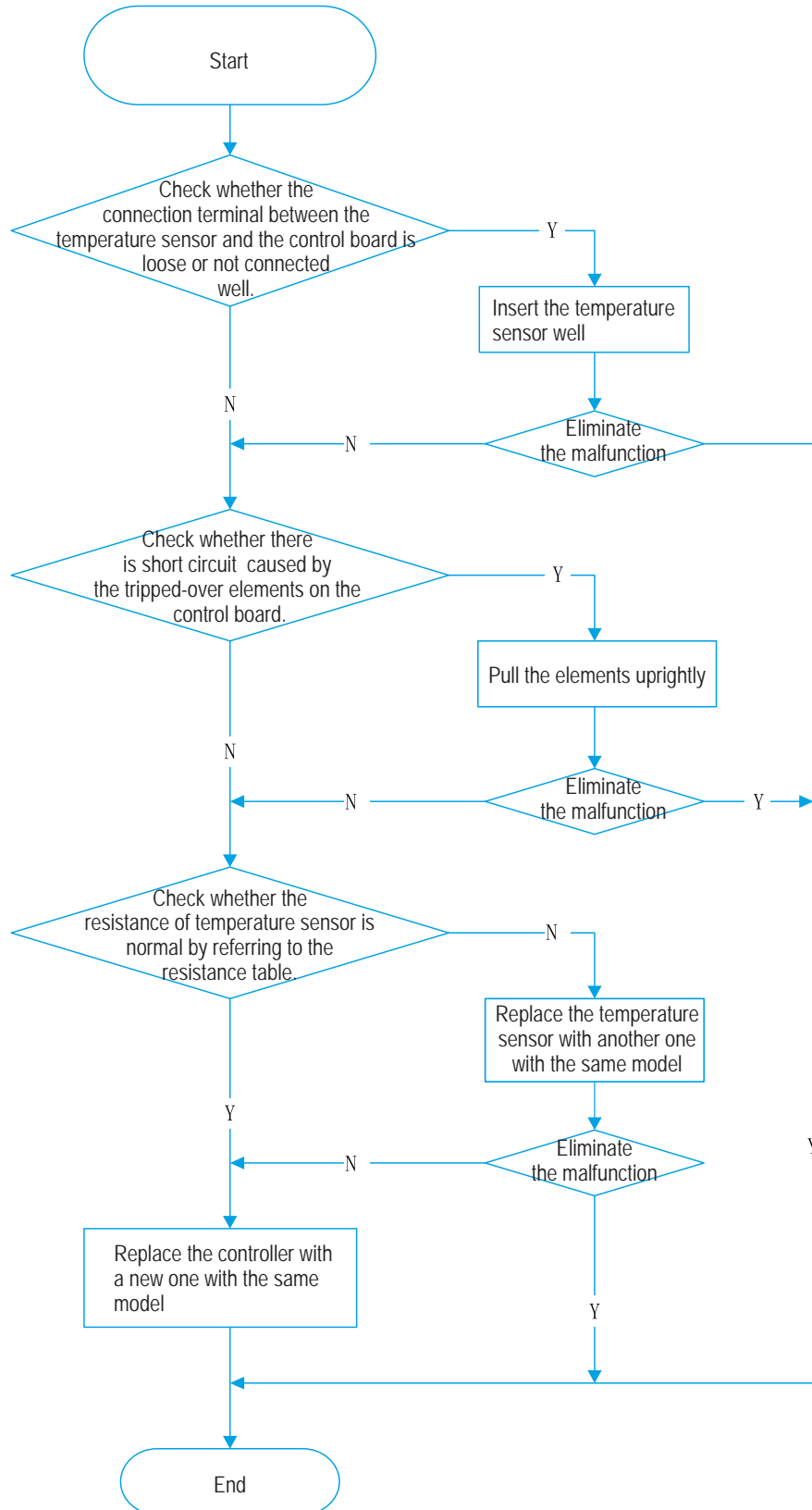

## 6. High temperature prevention protection E8; high power L9; system is abnormal H4

Main check points:

(1) outdoor temperature (2) fan (3)air inlet and air outlet of indoor/outdoor unit

NOTE: The control board as below means the control board of outdoor unit.

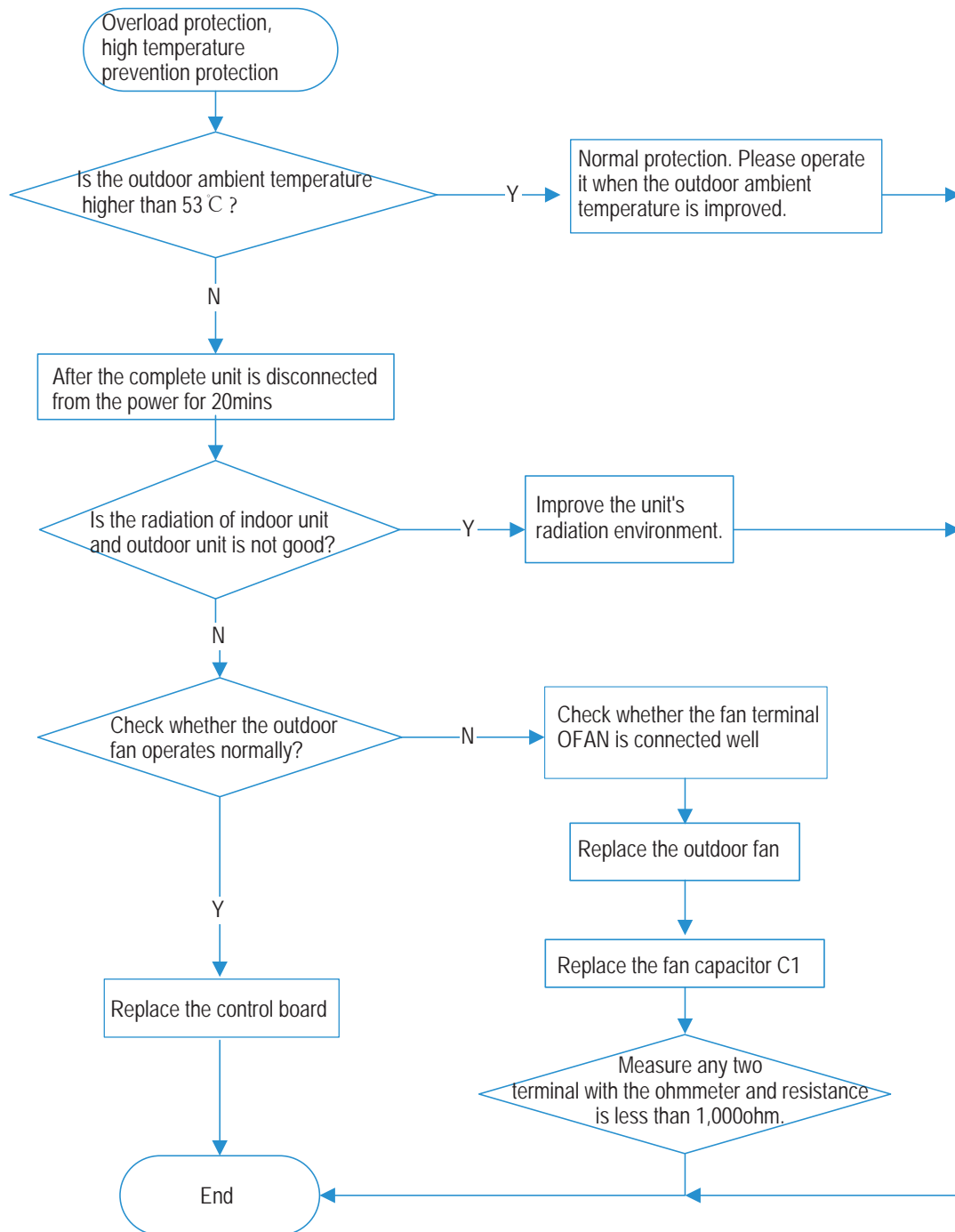

## 7. Desynchronization diagnosis for compressor H7

Main check point:

(1) system pressure (2) power supply voltage

NOTE: The control board as below means the control board of outdoor unit.

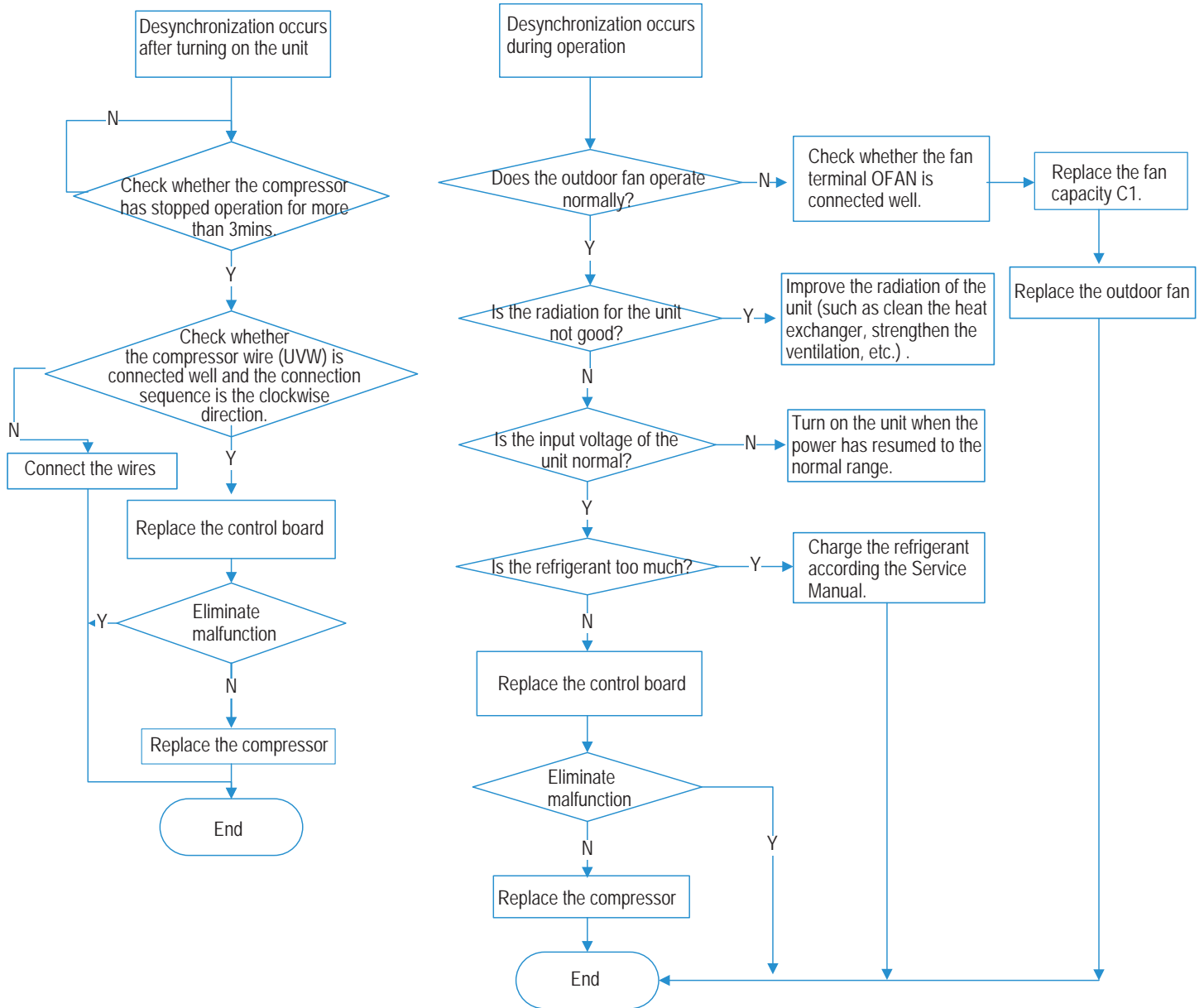

## 8. Malfunction diagnosis for failure startup $L_c$

Main check points:

(1) compressor wire (2) compressor (3) charging amount of refrigerant

NOTE: The control board as below means the control board of outdoor unit.

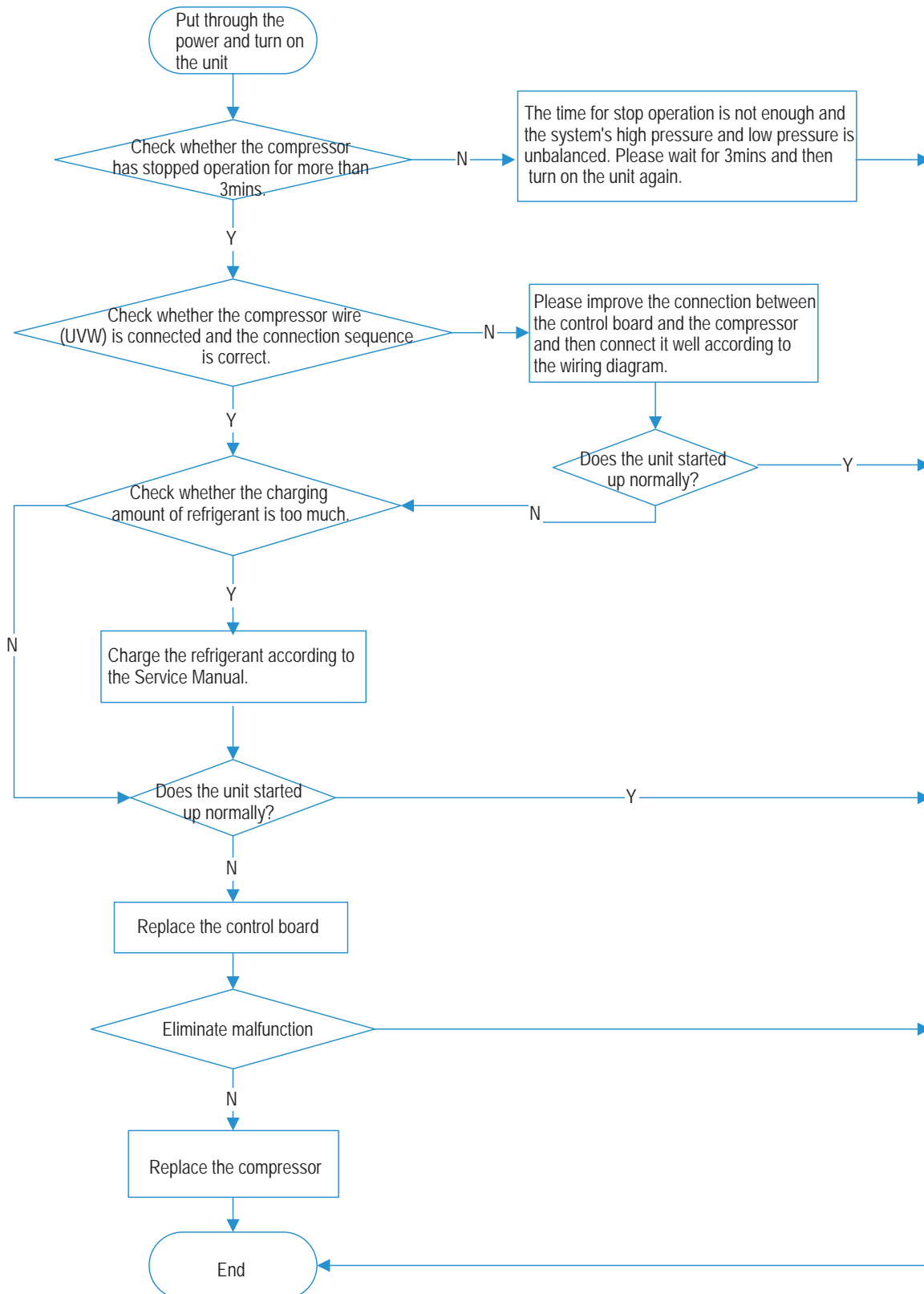

## 9. Charging malfunction of capacitor PU

Main check points:

(1) wiring board XT (2) reactor

NOTE: The control board as below means the control board of outdoor unit.

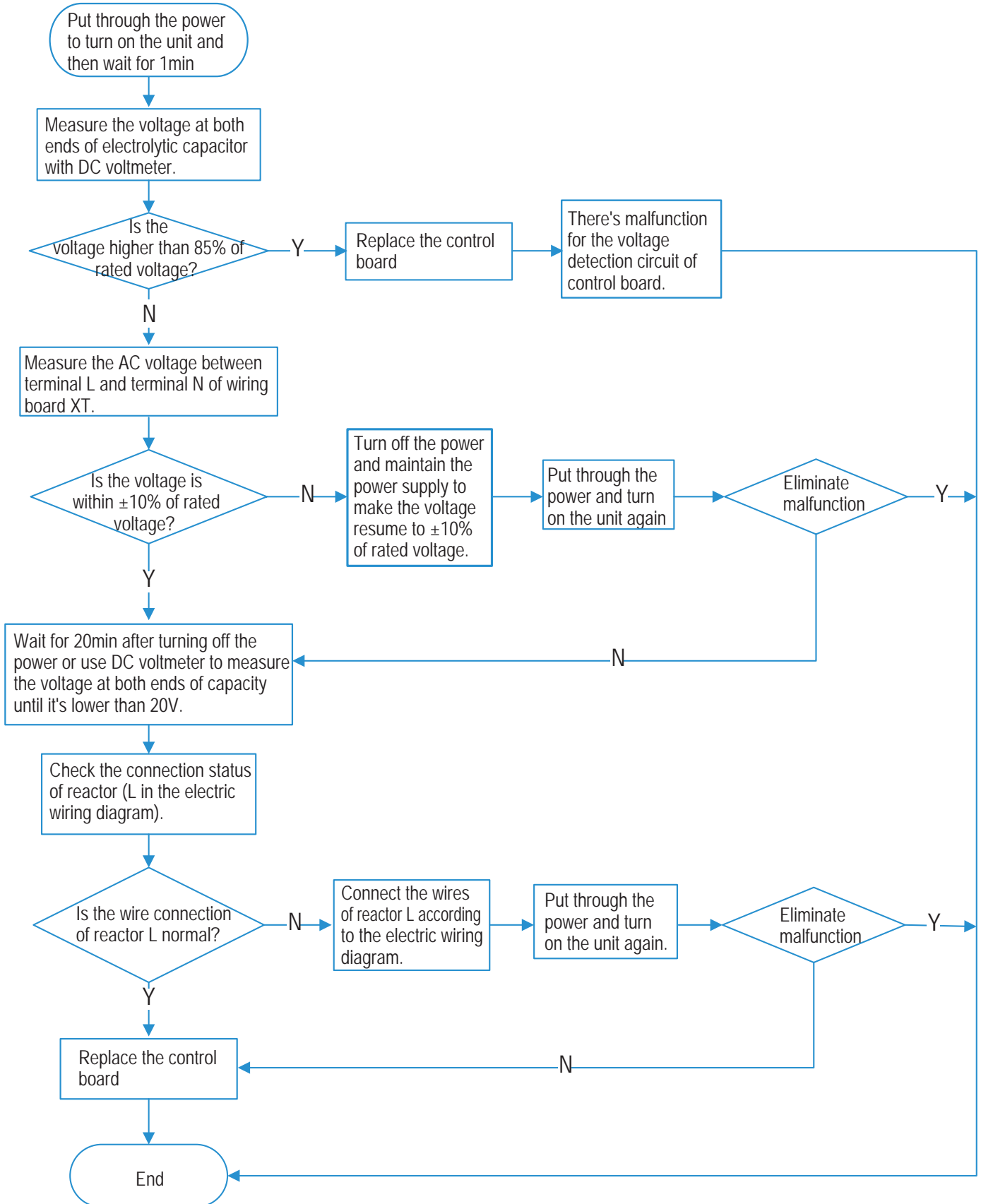

## 10. Troubleshooting-motor(indoor fan) doesn't operate H6

Main check points:

(1) connection terminal (2) motor (3) control board AP1 of indoor unit (4) blade

### 10.1 DC motor

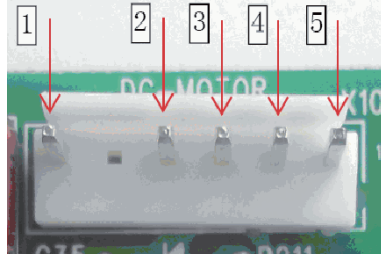
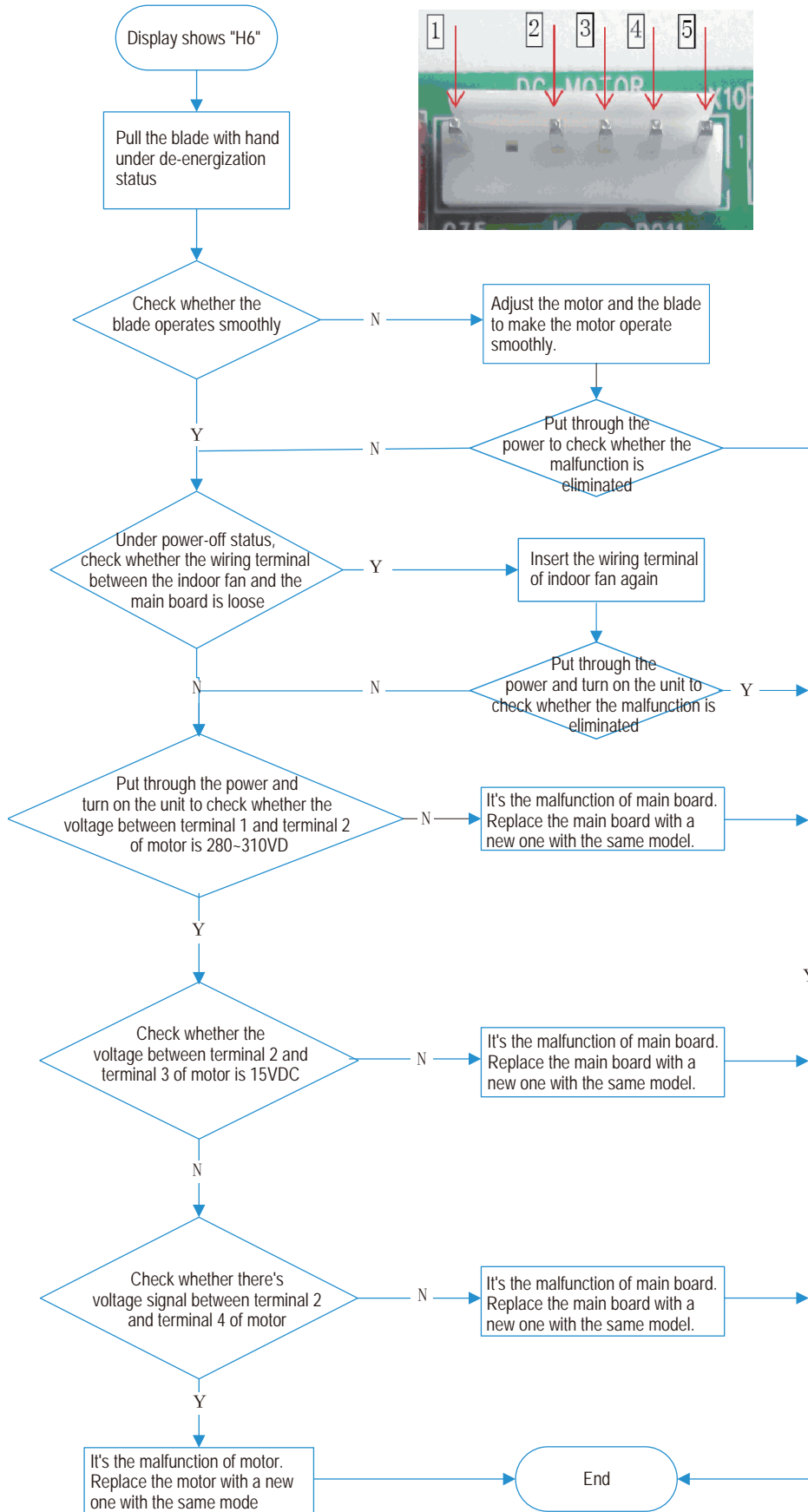

## 10.2 PG motor

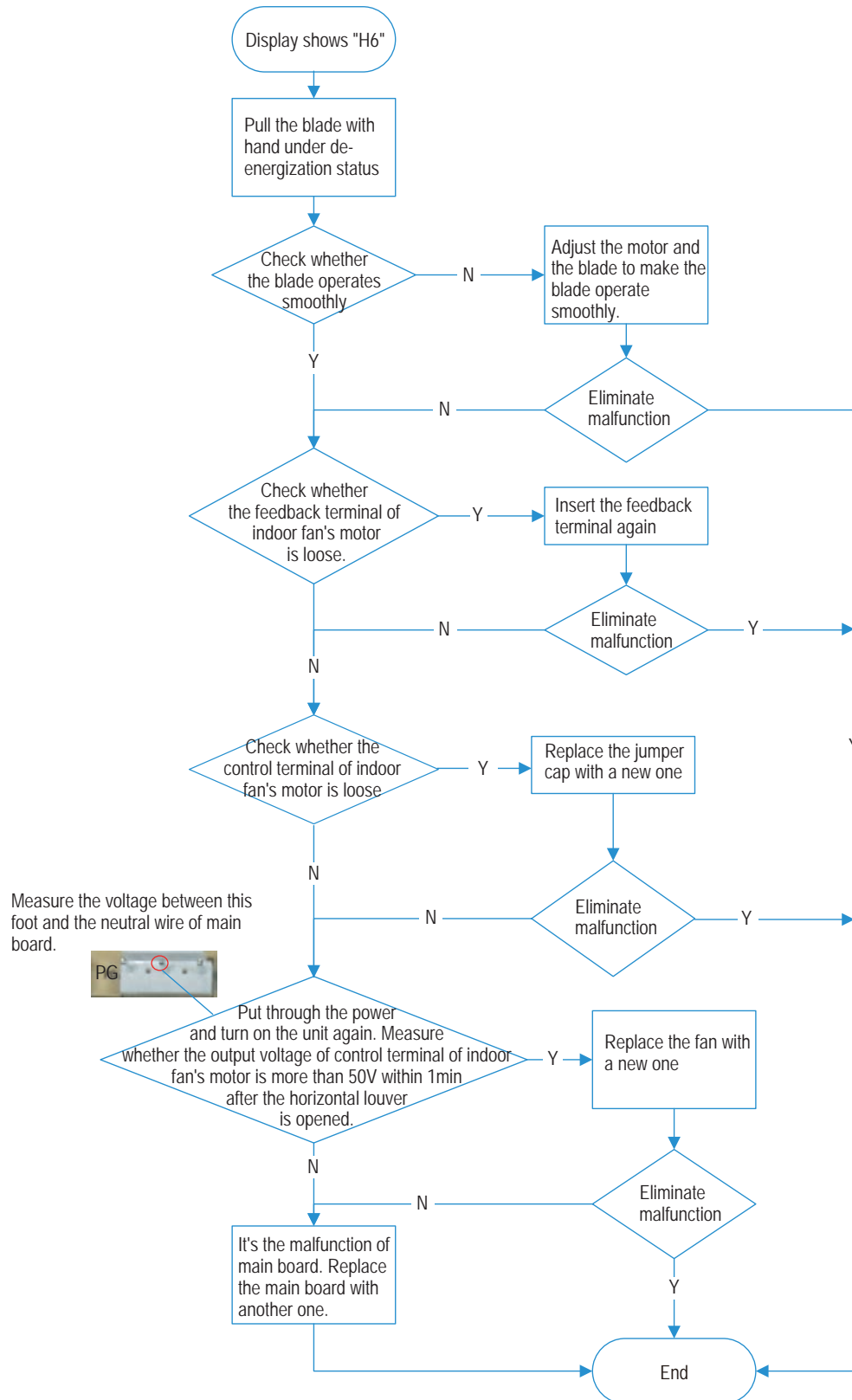



## 11. AC overcurrent protection E5

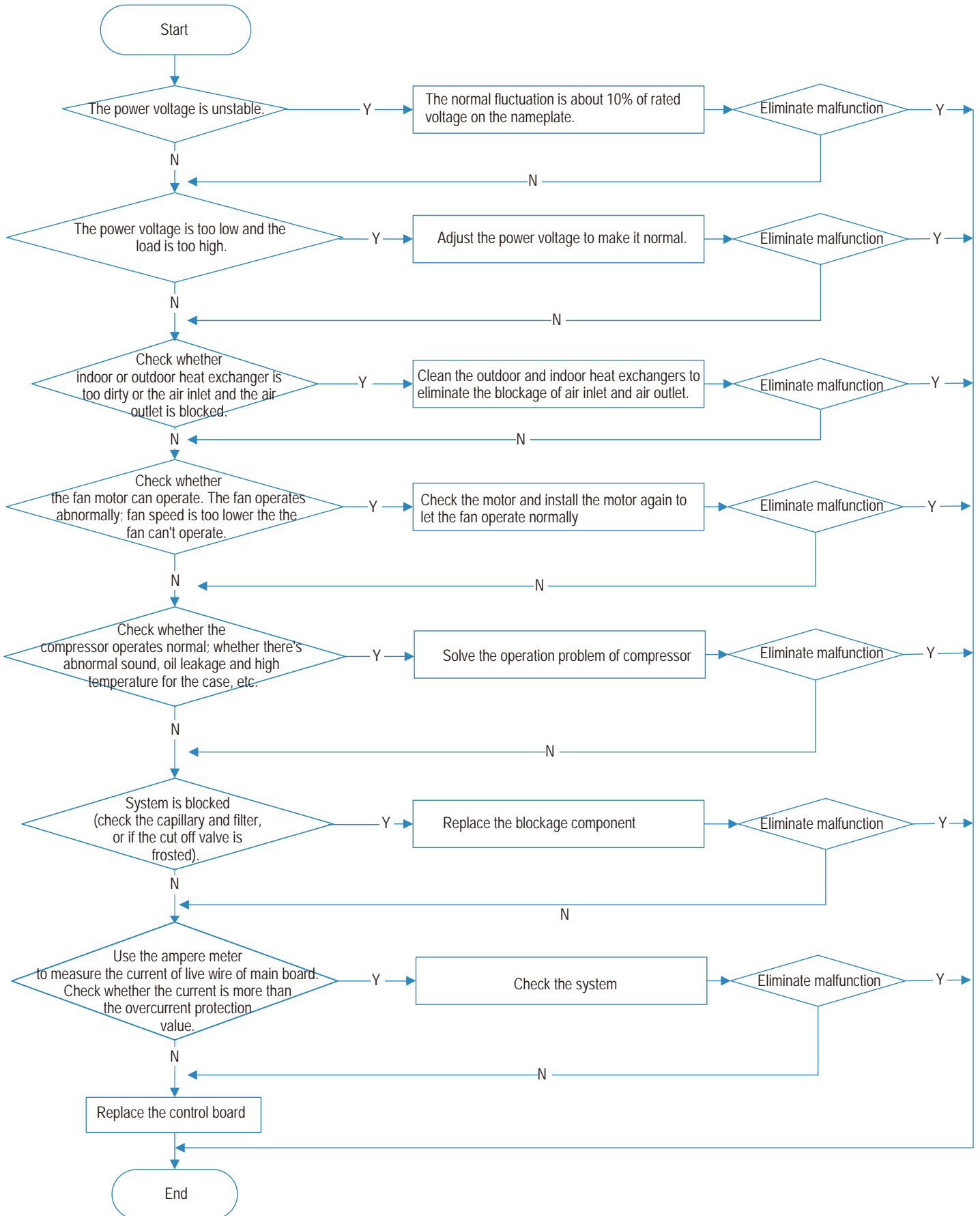

## 9.3 Troubleshooting for Normal Malfunction

### 1. Air Conditioner can't be Started Up

Possible Causes	Discriminating Method (Air conditioner Status)	Troubleshooting
No power supply, or poor connection for power plug	After energization, operation indicator isn't bright and the buzzer can't give out sound	Confirm whether it's due to power failure. If yes, wait for power recovery. If not, check power supply circuit and make sure the power plug is connected well.
Wrong wire connection between indoor unit and outdoor unit, or poor connection for wiring terminals	Under normal power supply circumstances, operation indicator isn't bright after energization	Check the circuit according to circuit diagram and connect wires correctly. Make sure all wiring terminals are connected firmly
Electric leakage for air conditioner	After energization, room circuit breaker trips off at once	Make sure the air conditioner is grounded reliably. Make sure wires of air conditioner is connected correctly. Check the wiring inside air conditioner. Check whether the insulation layer of power cord is damaged; if yes, place the power cord.
Model selection for air switch is improper	After energization, air switch trips off	Select proper air switch
Malfunction of remote controller	After energization, operation indicator is bright, while no display on remote controller or buttons have no action.	Replace batteries for remote controller Repair or replace remote controller

### 2. Poor Cooling (Heating) for Air Conditioner

Possible Causes	Discriminating Method (Air conditioner Status)	Troubleshooting
Set temperature is improper	Observe the set temperature on remote controller	Adjust the set temperature
Rotation speed of the IDU fan motor is set too low	Small wind blow	Set the fan speed at high or medium
Filter of indoor unit is blocked	Check the filter to see its blocked	Clean the filter
Installation position for indoor unit and outdoor unit is improper	Check whether the installation position is proper according to installation requirement for air conditioner	Adjust the installation position, and install the rain-proof and sunproof for outdoor unit
Refrigerant is leaking	Discharged air temperature during cooling is higher than normal discharged wind temperature; Discharged air temperature during heating is lower than normal discharged wind temperature; Units pressure is much lower than regulated range	Find out the leakage causes and deal with it. Add refrigerant.
Malfunction of 4-way valve	Blow cold wind during heating	Replace the 4-way valve
Malfunction of capillary	Discharged air temperature during cooling is higher than normal discharged wind temperature; Discharged air temperature during heating is lower than normal discharged wind temperature; Unit pressure is much lower than regulated range. If refrigerant isn't leaking, part of capillary is blocked	Replace the capillary
Flow volume of valve is insufficient	The pressure of valves is much lower than that stated in the specification	Open the valve completely
Malfunction of horizontal louver	Horizontal louver can't swing	Refer to point 3 of maintenance method for details
Malfunction of the IDU fan motor	The IDU fan motor can't operate	Refer to troubleshooting for H6 for maintenance method in details
Malfunction of the ODU fan motor	The ODU fan motor can't operate	Refer to point 4 of maintenance method for details
Malfunction of compressor	Compressor can't operate	Refer to point 5 of maintenance method for details

### 3. Horizontal Louver can't Swing

Possible Causes	Discriminating Method (Air conditioner Status)	Troubleshooting
Wrong wire connection, or poor connection	Check the wiring status according to circuit diagram	Connect wires according to wiring diagram to make sure all wiring terminals are connected firmly
Stepping motor is damaged	Stepping motor can't operate	Repair or replace stepping motor
Main board is damaged	Others are all normal, while horizontal louver can't operate	Replace the main board with the same model

#### 4. ODU Fan Motor can't Operate

Possible causes	Discriminating method (air conditioner status)	Troubleshooting
Wrong wire connection, or poor connection	Check the wiring status according to circuit diagram	Connect wires according to wiring diagram to make sure all wiring terminals are connected firmly
Capacity of the ODU fan motor is damaged	Measure the capacity of fan capacitor with an universal meter and find that the capacity is out of the deviation range indicated on the nameplate of fan capacitor.	Replace the capacity of fan
Power voltage is a little low or high	Use universal meter to measure the power supply voltage. The voltage is a little high or low	Suggest to equip with voltage regulator
Motor of outdoor unit is damaged	When unit is on, cooling/heating performance is bad and ODU compressor generates a lot of noise and heat.	Change compressor oil and refrigerant. If no better, replace the compressor with a new one

#### 5. Compressor can't Operate

Possible causes	Discriminating method (air conditioner status)	Troubleshooting
Wrong wire connection, or poor connection	Check the wiring status according to circuit diagram	Connect wires according to wiring diagram to make sure all wiring terminals are connected firmly
Capacity of compressor is damaged	Measure the capacity of fan capacitor with an universal meter and find that the capacity is out of the deviation range indicated on the nameplate of fan capacitor.	Replace the compressor capacitor
Power voltage is a little low or high	Use universal meter to measure the power supply voltage. The voltage is a little high or low	Suggest to equip with voltage regulator
Coil of compressor is burnt out	Use universal meter to measure the resistance between compressor terminals and it's 0	Repair or replace compressor
Cylinder of compressor is blocked	Compressor can't operate	Repair or replace compressor

#### 6. Air Conditioner is Leaking

Possible causes	Discriminating method (air conditioner status)	Troubleshooting
Drain pipe is blocked	Water leaking from indoor unit	Eliminate the foreign objects inside the drain pipe
Drain pipe is broken	Water leaking from drain pipe	Replace drain pipe
Wrapping is not tight	Water leaking from the pipe connection place of indoor unit	Wrap it again and bundle it tightly

#### 7. Abnormal Sound and Vibration

Possible causes	Discriminating method (air conditioner status)	Troubleshooting
When turn on or turn off the unit, the panel and other parts will expand and there's abnormal sound	There's the sound of "PAPA"	Normal phenomenon. Abnormal sound will disappear after a few minutes.
When turn on or turn off the unit, there's abnormal sound due to flow of refrigerant inside air conditioner	Water-running sound can be heard	Normal phenomenon. Abnormal sound will disappear after a few minutes.
Foreign objects inside the indoor unit or there are parts touching together inside the indoor unit	There's abnormal sound fro indoor unit	Remove foreign objects. Adjust all parts position of indoor unit, tighten screws and stick damping plaster between connected parts
Foreign objects inside the outdoor unit or there are parts touching together inside the outdoor unit	There's abnormal sound fro outdoor unit	Remove foreign objects. Adjust all parts position of outdoor unit, tighten screws and stick damping plaster between connected parts
Short circuit inside the magnetic coil	During heating, the way valve has abnormal electromagnetic sound	Replace magnetic coil
Abnormal shake of compressor	Outdoor unit gives out abnormal sound	Adjust the support foot mat of compressor, tighten the bolts
Abnormal sound inside the compressor	Abnormal sound inside the compressor	If add too much refrigerant during maintenance, please reduce refrigerant properly. Replace compressor for other circumstances.

# 10. Exploded View and Parts List

## 10.1 Indoor Unit

ACA / ACB model

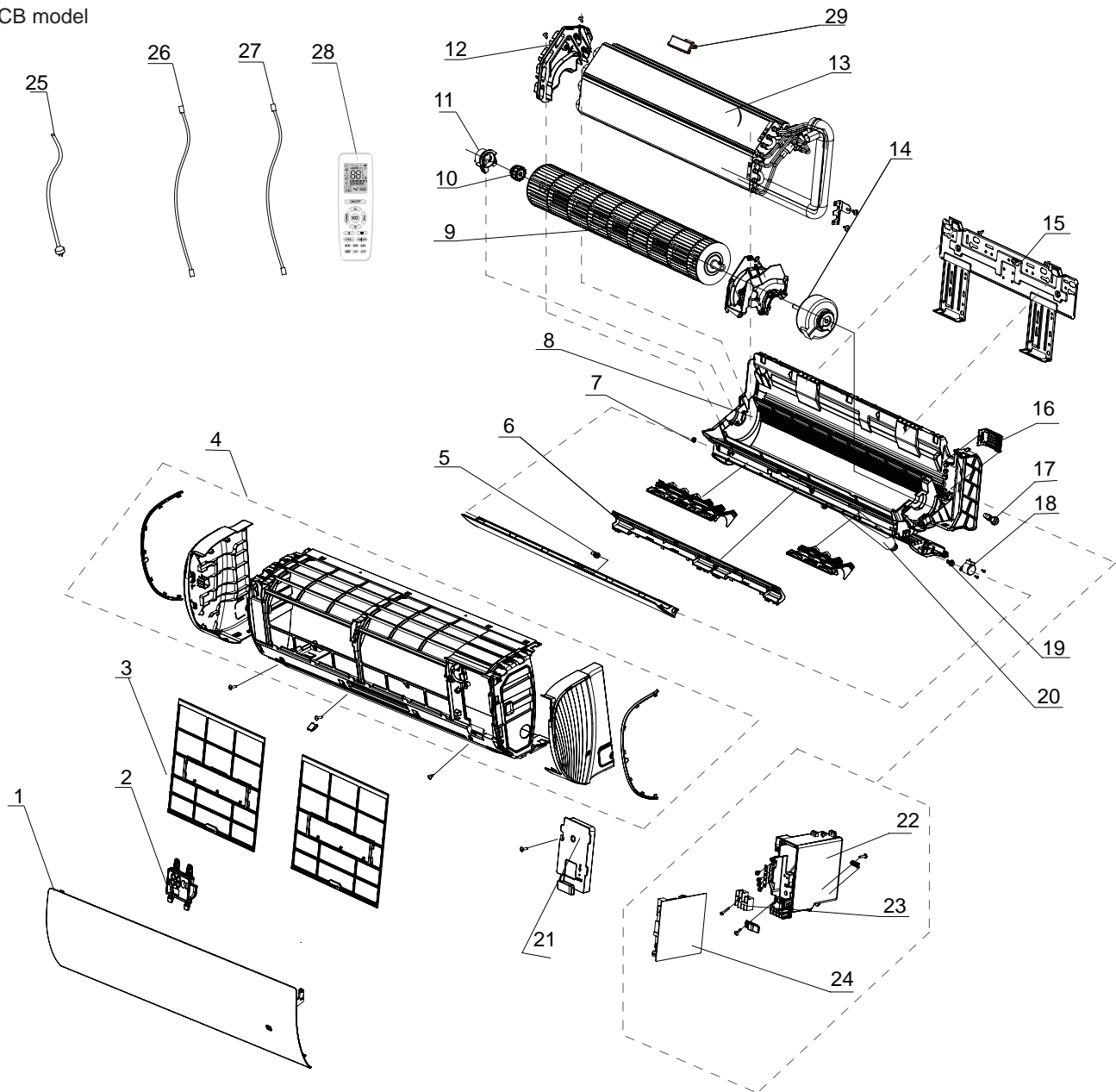

The component picture is only for reference; please refer to the actual product.

NO.	Description	NO.	Description
1	Front Panel	16	Connecting pipe clamp
2	Display Board	17	Rubber Plug (Water Tray)
3	Filter Sub-Assy	18	Stepping Motor
4	Front Case Assy	19	Crank
5	Axile Bush	20	Drainage Hose
6	Helicoid Tongue	21	Electric Box Cover2
7	Left Axile Bush	22	Electric Box Assy
8	Rear Case assy	23	Terminal Board
9	Cross Flow Fan	24	Main Board
10	O-Gasket sub-assy of Bearing	25	Power Cord
11	Ring of Bearing	26	Connecting Cable
12	Evaporator Support	27	Connecting Cable
13	Evaporator Assy	28	Remote Controller
14	Fan Motor	29	Cold Plasma Generator
15	Wall Mounting Frame Sub-assy		

Some models may not contain some parts, please refer to the actual product.

ACC model (Vertical Auto Swing)

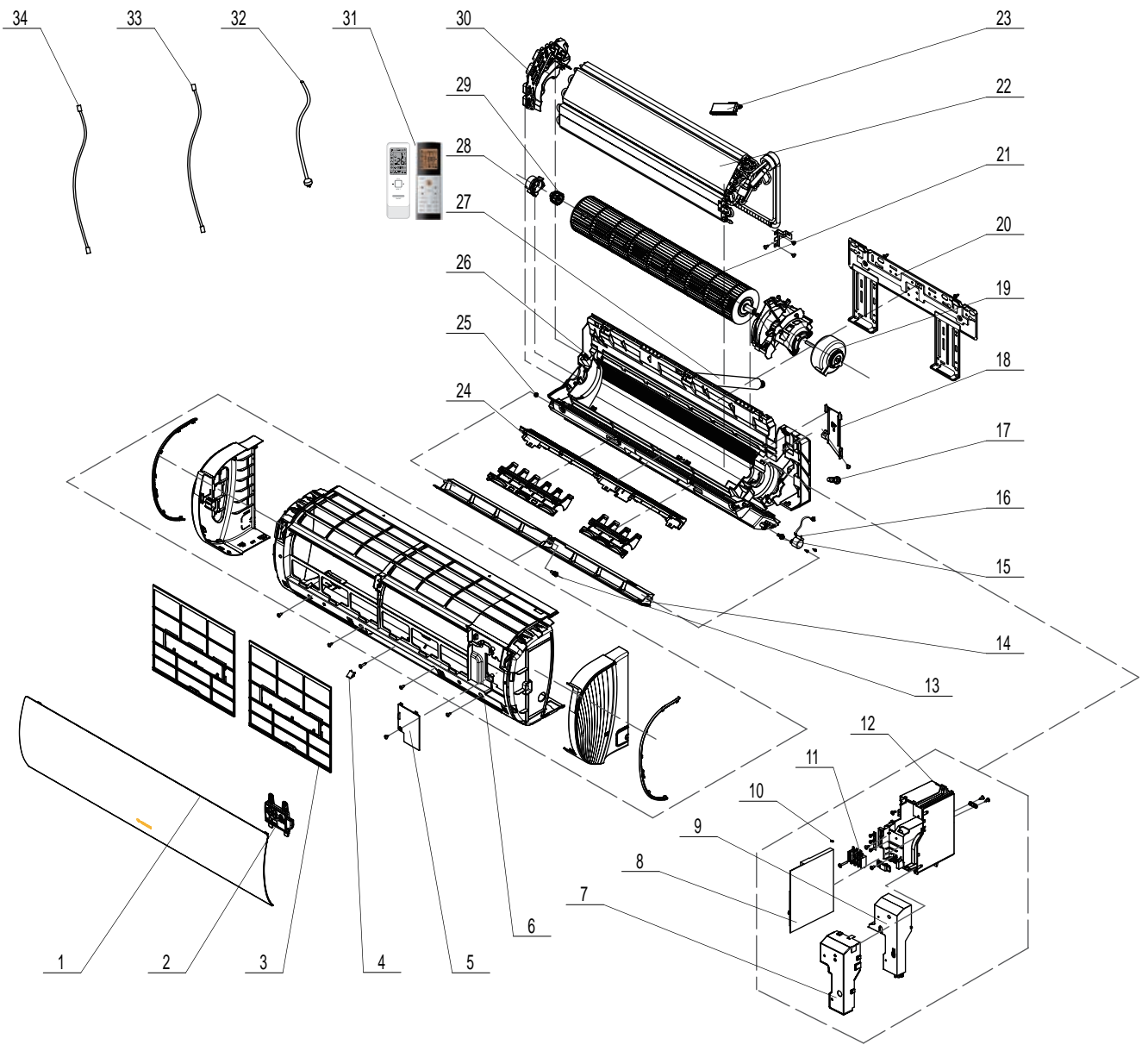

The component picture is only for reference; please refer to the actual product.

NO.	Description	NO.	Description
1	Front Panel	18	Connecting pipe clamp
2	Display Board	19	Fan Motor
3	Filter Sub-Assy	20	Wall Mounting Frame
4	Screw Cover	21	Cross Flow Fan
5	Electric Box Cover Sub-Assy	22	Evaporator Assy
6	Front Case Assy	23	Cold Plasma Generator
7	Shield Cover of Electric Box Cover	24	Helicoid Tongue
8	Main Board	25	Left Axile Bush
9	Electric Box Cover	26	Rear Case assy
10	Jumper	27	Drainage Hose
11	Terminal Board	28	Ring of Bearing
12	Electric Box Assy	29	O-Gasket sub-assy of Bearing
13	Axile Bush	30	Evaporator Support 2
14	Guide Louver	31	Remote Controller
15	Crank	32	Power Cord
16	Stepping Motor	33	Connecting Cable
17	Rubber Plug (Water Tray)	34	Connecting Cable

Some models may not contain some parts, please refer to the actual product.



ACC model (4-Dimension Swing)

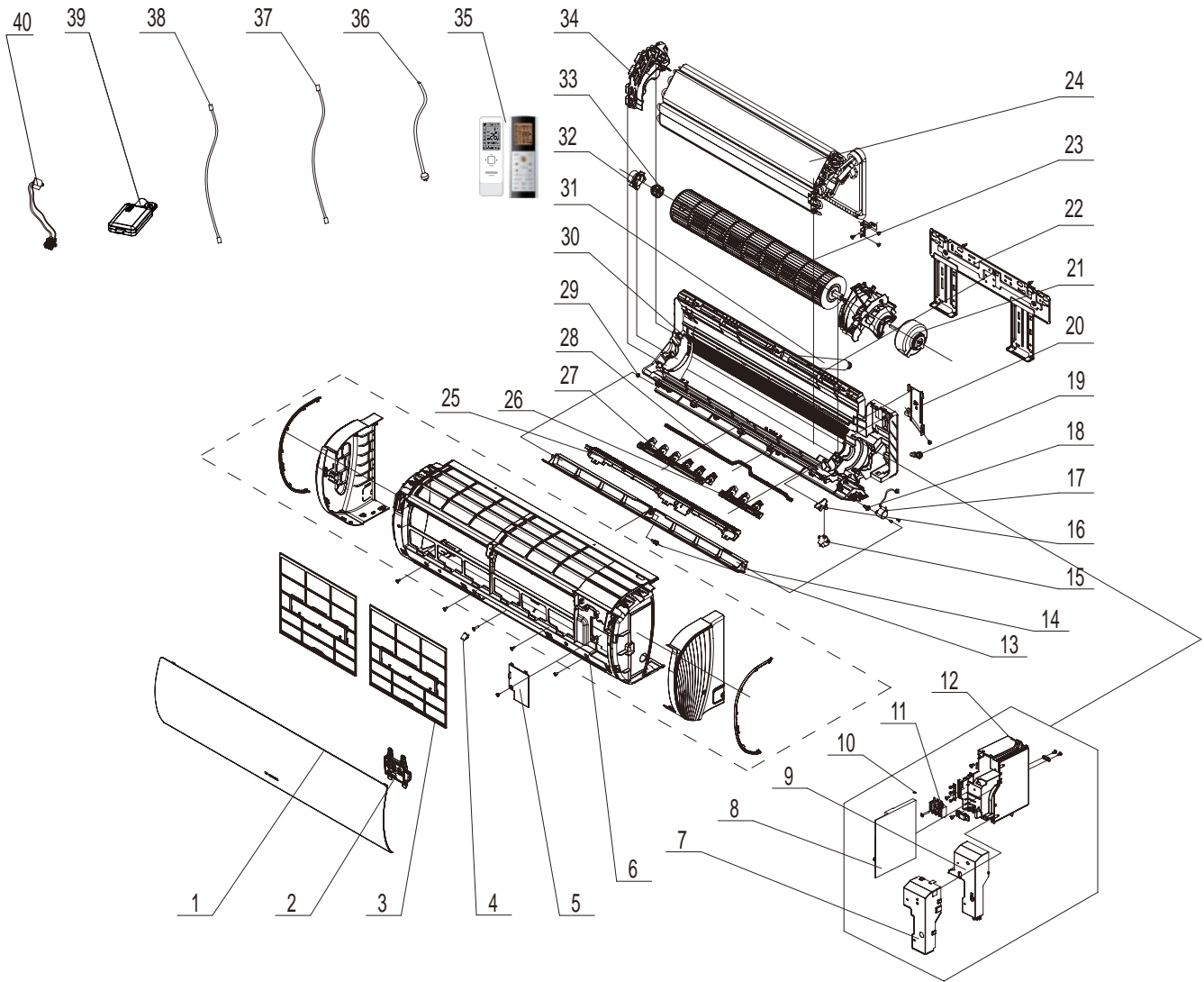

The component picture is only for reference; please refer to the actual product.

NO.	Description	NO.	Description
1	Front Panel	21	Fan Motor
2	Display Board	22	Wall Mounting Frame
3	Filter Sub-Assy	23	Cross Flow Fan
4	Screw Cover	24	Evaporator Assy
5	Electric Box Cover Sub-Assy	25	Helicoid Tongue
6	Front Case Assy	26	Air Louver(right)
7	Shield Cover of Electric Box Cover	27	Air Louver (left)
8	Main Board	28	Swing Lever
9	Electric Box Cover	29	Left Axile Bush
10	Jumper	30	Rear Case assy
11	Terminal Board	31	Drainage Hose
12	Electric Box Assy	32	Ring of Bearing
13	Axile Bush	33	O-Gasket sub-assy of Bearing
14	Guide Louver	34	Evaporator Support 2
15	Stepping Motor	35	Remote Controller
16	Air Louver (Auto)	36	Power Cord
17	Stepping Motor	37	Connecting Cable
18	Crank	38	Connecting Cable
19	Rubber Plug (Water Tray)	39	Detecting Plate
20	Connecting pipe clamp	40	Cold Plasma Generator

Some models may not contain some parts, please refer to the actual product.

ACD model (Vertical Auto Swing)

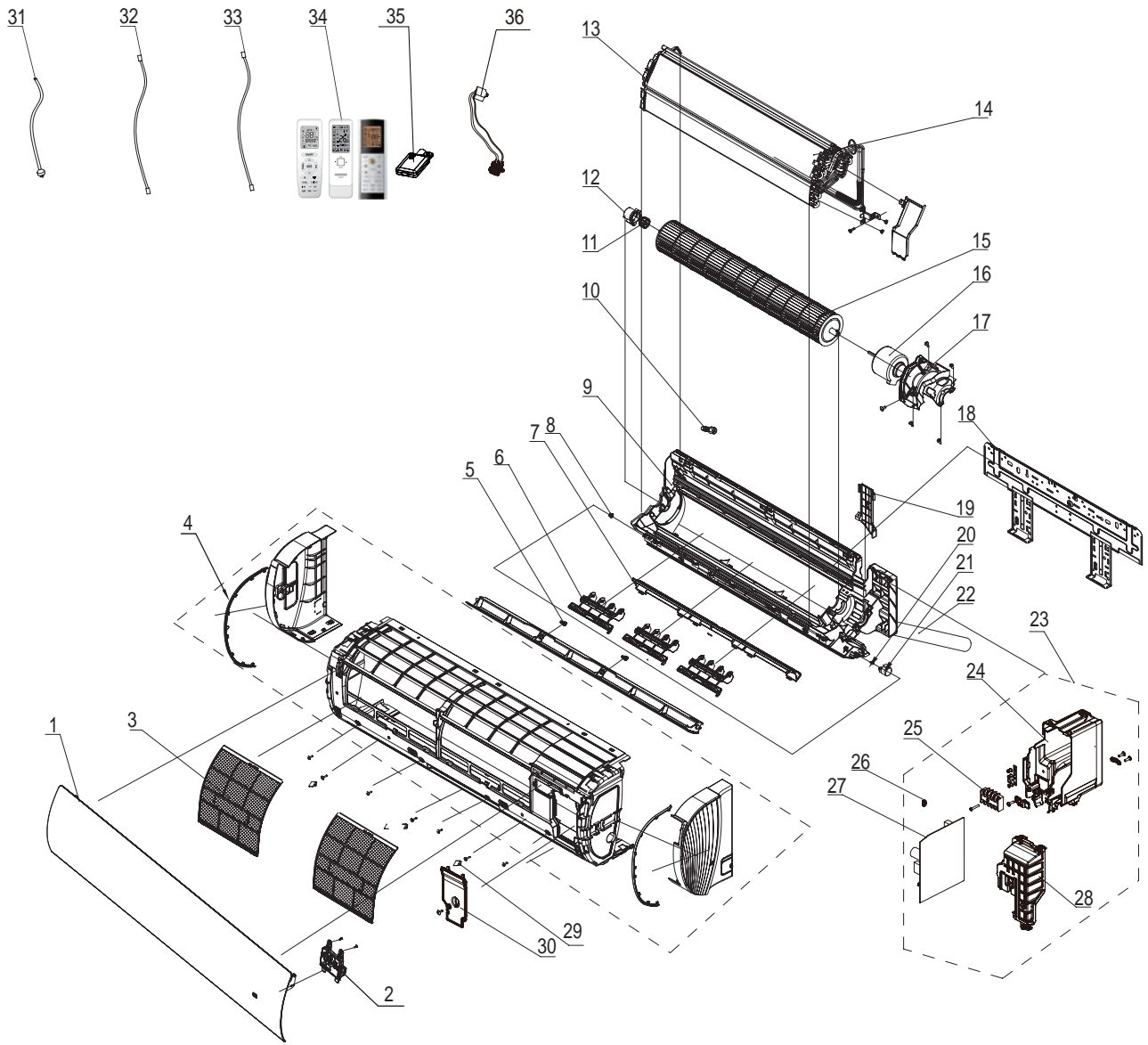

The component picture is only for reference; please refer to the actual product.

NO.	Description	NO.	Description
1	Front Panel	19	Connecting pipe clamp
2	Display Board	20	Crank
3	Filter Sub-Assy	21	Stepping Motor
4	Front Case Assy	22	Drainage hose
5	Axile Bush	23	Electric Box Assy
6	Air Louver(Manual)	24	Electric Box
7	Helicoid tongue	25	Terminal Board
8	Left Axile Bush	26	Jumper
9	Rear Case assy	27	Main Board
10	Rubber Plug (Water Tray)	28	Electric Box Cover
11	O-Gasket sub-assy of Bearing	29	Screw Cover
12	Ring of Bearing	30	Electric Box Cover2
13	Evaporator Support	31	Power Cord
14	Evaporator Assy	32	Connecting Cable
15	Cross Flow Fan	33	Connecting Cable
16	Fan Motor	34	Remote Controller
17	Motor Press Plate	35	Detecting Plate
18	Wall Mounting Frame	36	Cold Plasma Generator

Some models may not contain some parts, please refer to the actual product.

ACD model (4-Dimension Swing)

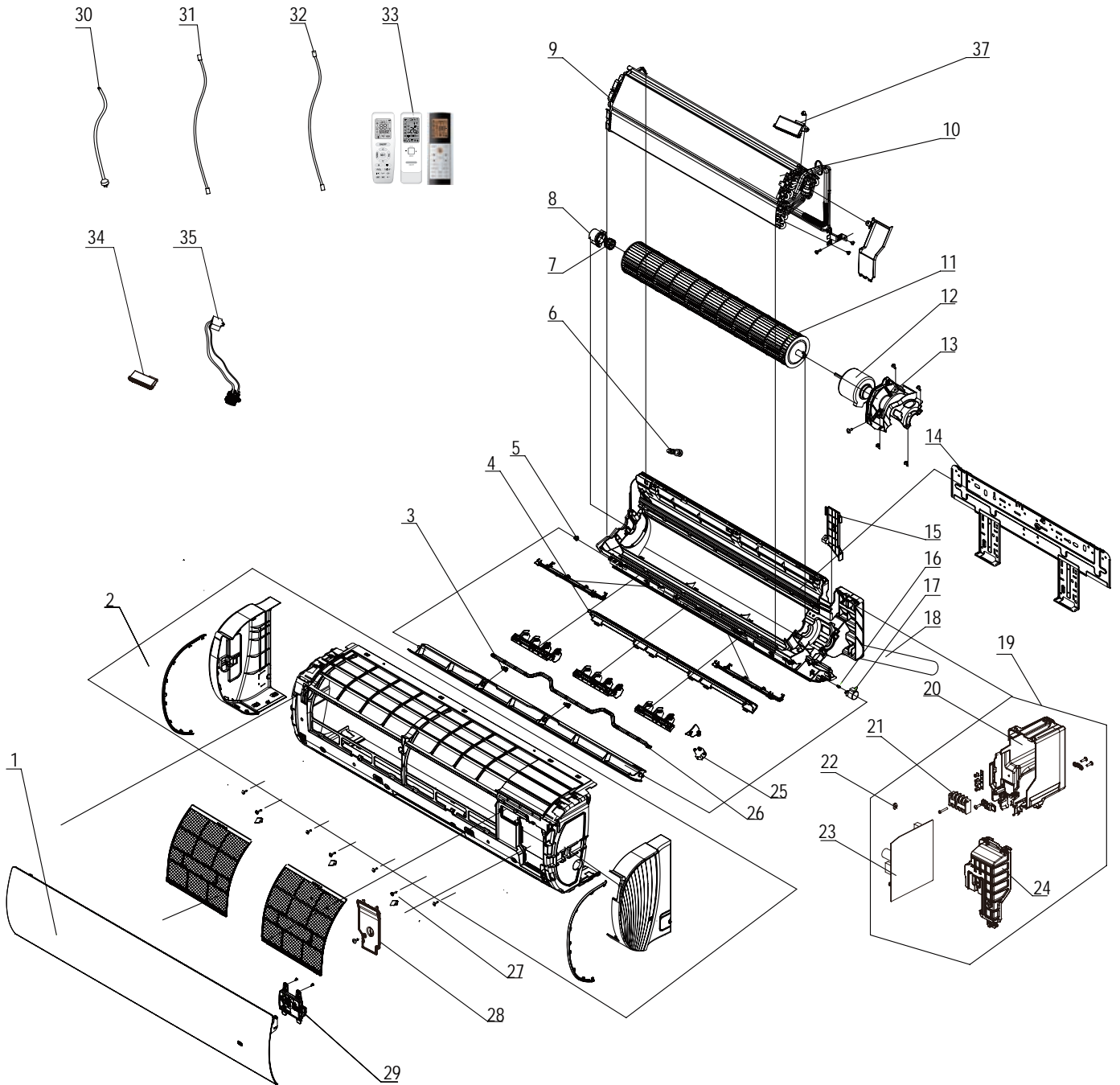

The component picture is only for reference; please refer to the actual product.

NO.	Description	NO.	Description
1	Front Panel	19	Electric Box Assy
2	Front Case	20	Electric Box
3	Axile Bush	21	Jumper
4	Helicoid Tongue	22	Terminal Board
5	Left Axile Bush	23	Main Board
6	Rubber Plug (Water Tray)	24	Electric Box Cover
7	O-Gasket sub-assy of Bearing	25	Stepping Motor
8	Ring of Bearing	26	Swing Lever
9	Evaporator Support	27	Screw Cover
10	Evaporator Assy	28	Electric Box Cover2
11	Cross Flow Fan	29	Display Board
12	Fan Motor	30	Power Cord
13	Motor Press Plate	31	Connecting Cable
14	Wall Mounting Frame	32	Connecting Cable
15	Connecting pipe clamp	33	Remote Controller
16	Crank	34	Detecting Plate
17	Stepping Motor	35	Cold Plasma Generator
18	Drainage hose		

Some models may not contain some parts, please refer to the actual product.

ACE model (Vertical Auto Swing)

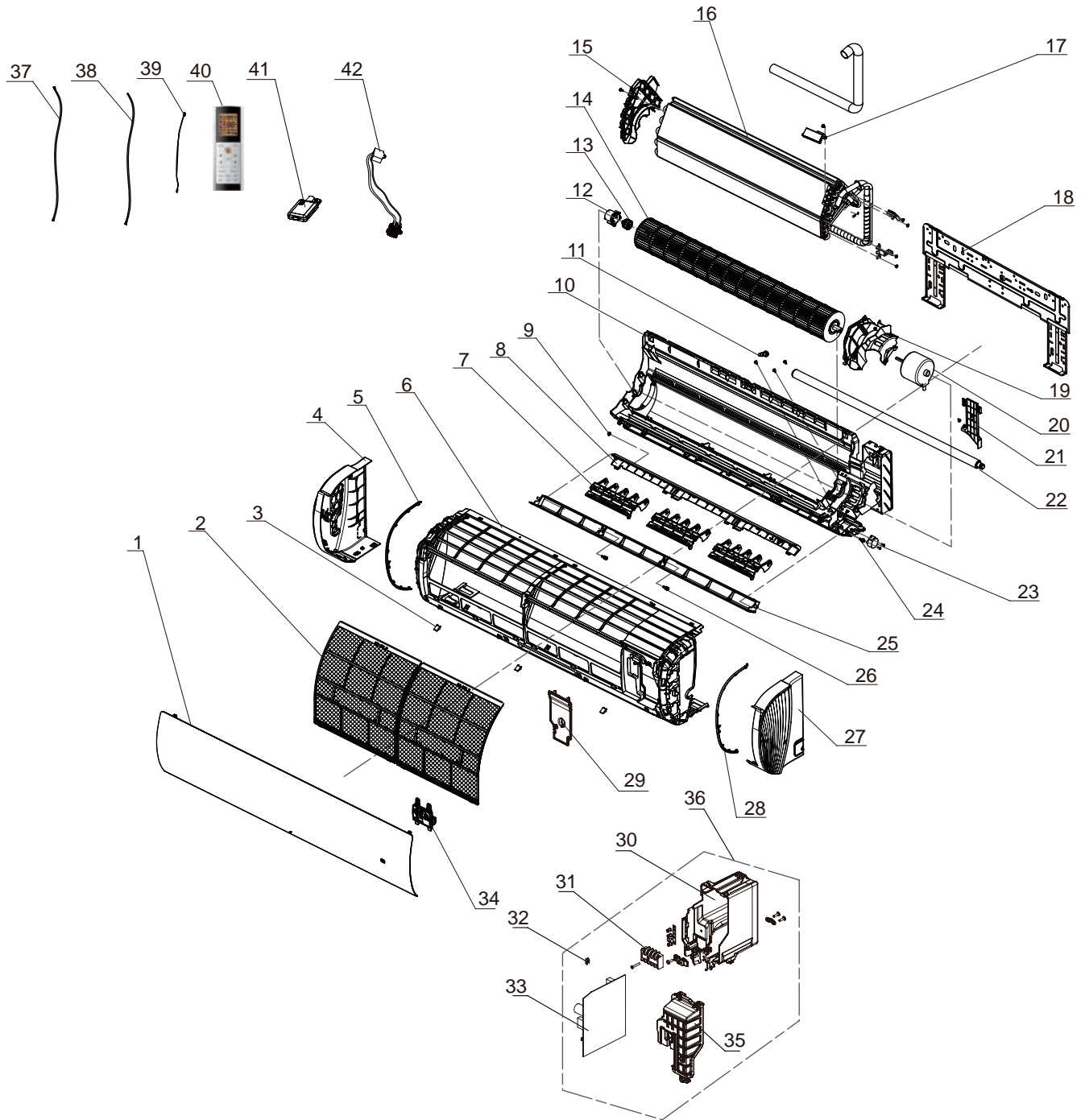

The component picture is only for reference; please refer to the actual product.



NO.	Description	NO.	Description
1	Front Panel	22	Drainage Hose
2	Filter Sub-Assy	23	Stepping Motor
3	Screw Cover	24	Crank
4	Left Side Plate	25	Guide Louver
5	Decorative Strip(Left)	26	Axile Bush
6	Front Case	27	Decorative Strip(Right)
7	Air Louver(Manual)	28	Right Side Plate
8	Helicoid Tongue	29	Electric Box Cover2
9	Left Axile Bush	30	Electric Box
10	Rear Case assy	31	Terminal Board
11	Rubber Plug (Water Tray)	32	Jumper
12	Ring of Bearing	33	Main Board
13	O-Gasket sub-assy of Bearing	34	Display Board
14	Cross Flow Fan	35	Electric Box Cover
15	Evaporator Support	36	Electric Box Assy
16	Evaporator Assy	37	Connecting Cable
17	Cold Plasma Generator	38	Connecting Cable
18	Wall Mounting Frame	39	Temperature Sensor
19	Motor Press Plate	40	Remote Controller
20	Fan Motor	41	Detecting Plate
21	Connecting pipe clamp	42	Cold Plasma Generator

Some models may not contain some parts, please refer to the actual product.

ACE model (4-Dimension Swing)

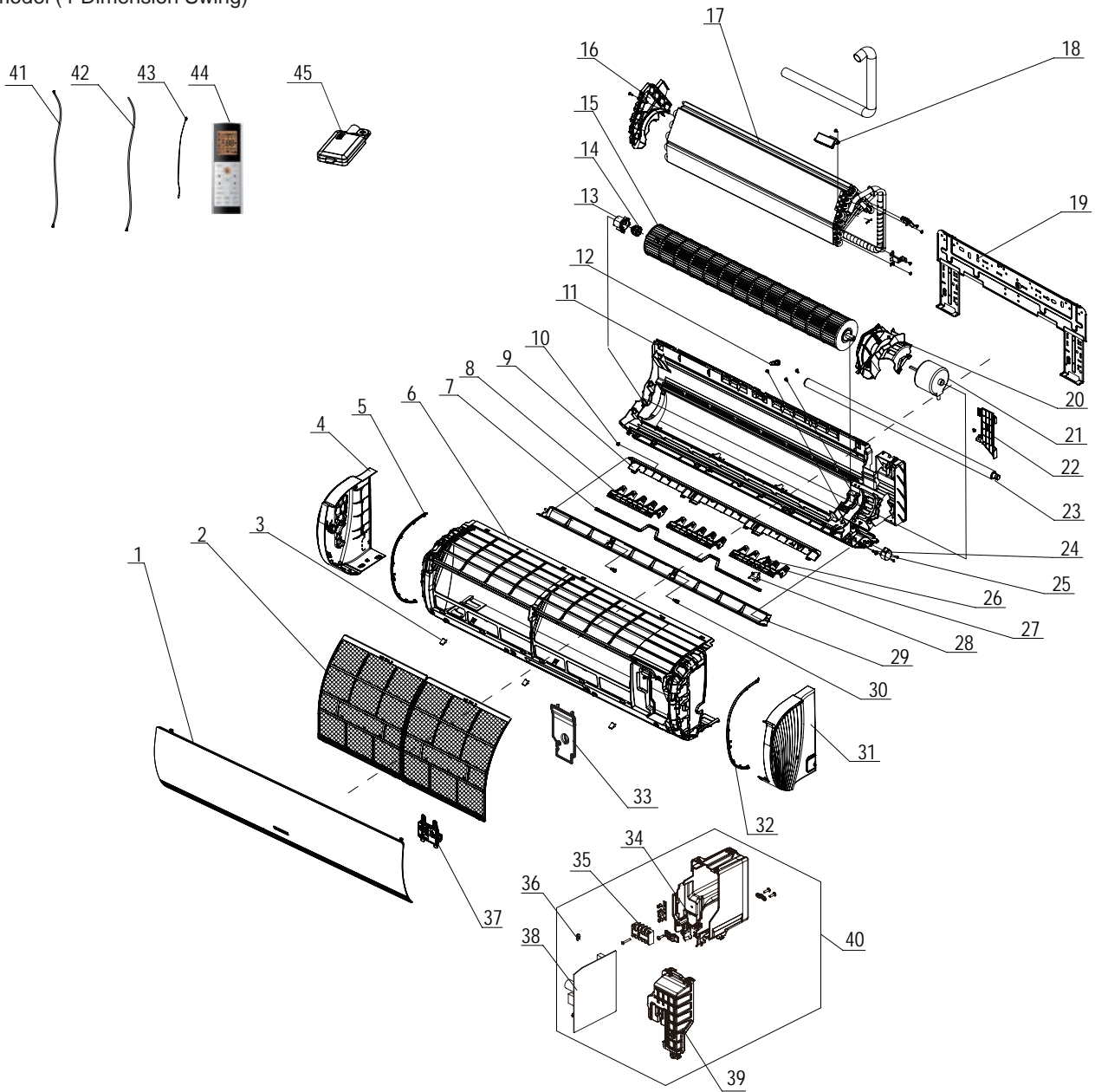

The component picture is only for reference; please refer to the actual product.

NO.	Description	NO.	Description
1	Front Panel	24	Crank
2	Filter Sub-Assy	25	Stepping Motor
3	Screw Cover	26	Air Louver
4	Left Side Plate	27	Air Louver 1
5	Decorative Strip(Left)	28	Stepping Motor
6	Front Case	29	Guide Louver
7	Swing Lever	30	Axile Bush
8	Air Louver 1	31	Right Side Plate
9	Helicoid Tongue	32	Decorative Strip(Right)
10	Left Axile Bush	33	Electric Box Cover2
11	Rear Case assy	34	Electric Box
12	Rubber Plug (Water Tray)	35	Terminal Board
13	Ring of Bearing	36	Jumper
14	O-Gasket sub-assy of Bearing	37	Display Board
15	Cross Flow Fan	38	Main Board
16	Evaporator Support	39	Electric Box Cover
17	Evaporator Assy	40	Electric Box Assy
18	Cold Plasma Generator	41	Connecting Cable
19	Wall Mounting Frame	42	Connecting Cable
20	Motor Press Plate	43	Temperature Sensor
21	Fan Motor	44	Remote Controller
22	Connecting pipe clamp	45	Detecting Plate
23	Drainage Hose		

Some models may not contain some parts, please refer to the actual product.

## 10.2 Outdoor Unit

GWH07AGA-K6DNA1A/O

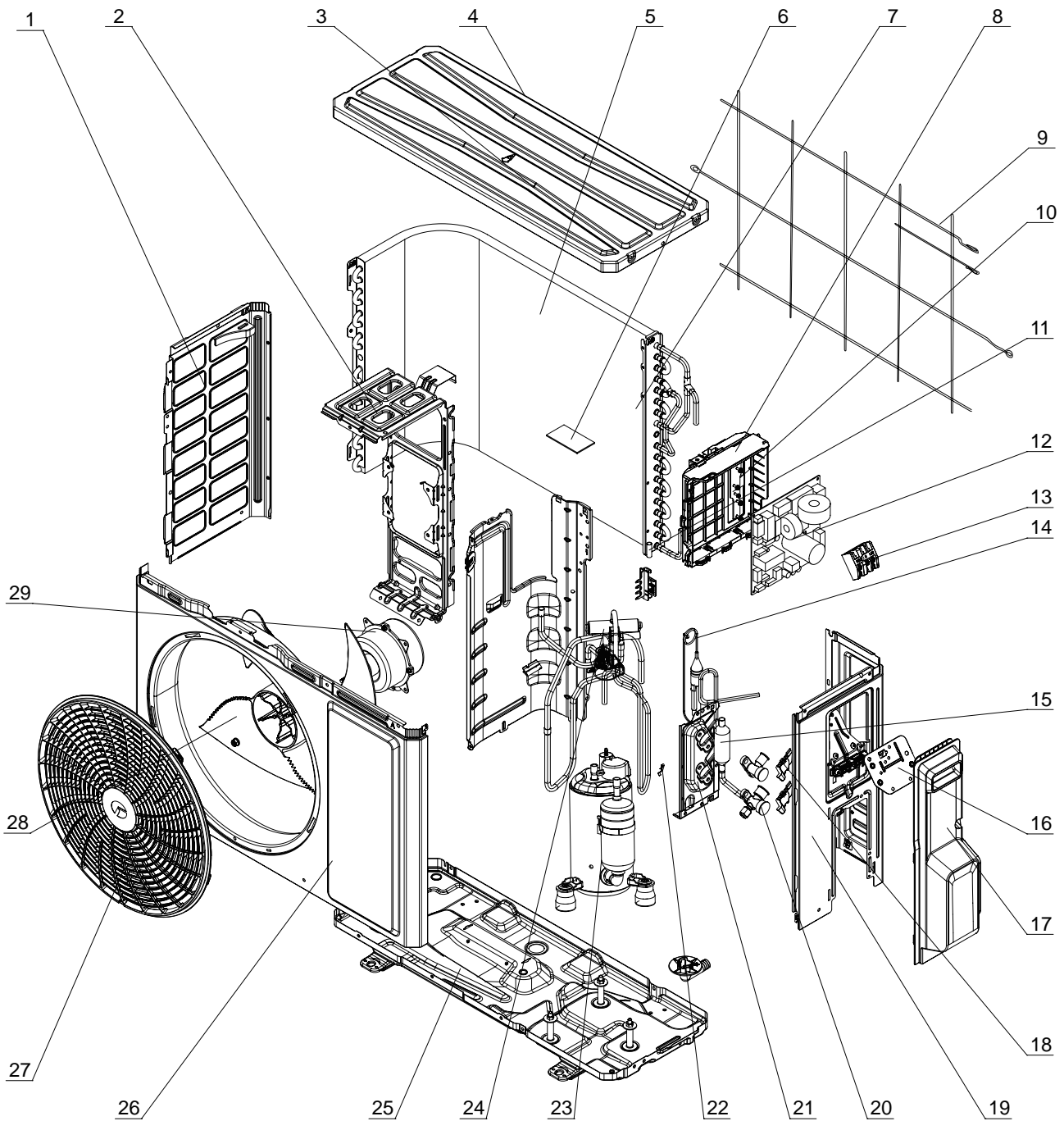

The component is only for reference; please refer to the actual product

NO.	Description	NO.	Description
1	Left Side Plate	16	Earthing Plate Sub-Assy
2	Motor Support	17	Handle
3	Top Cover Sub-Assy	18	Valve Support Block
4	Top Cover	19	Right Side Plate
5	Condenser Sub-Assy	20	Cut off Valve 1/4
6	Sponge(Condenser)	21	Valve Support
7	Condenser Assy	22	Sensor Insert
8	Electric Box Assy	23	Compressor and Fittings
9	Rear Grill	24	4-Way Valve Assy
10	Electric Box	25	Chassis Sub-Assy
11	Temp Sensor Sleeving	26	Cabinet
12	Main Board	27	Front Grill
13	Terminal Board	28	Axial Flow Fan
14	Capillary Sub-Assy	29	Fan Motor
15	Silencer		

Some models may not contain some parts, please refer to the actual product.

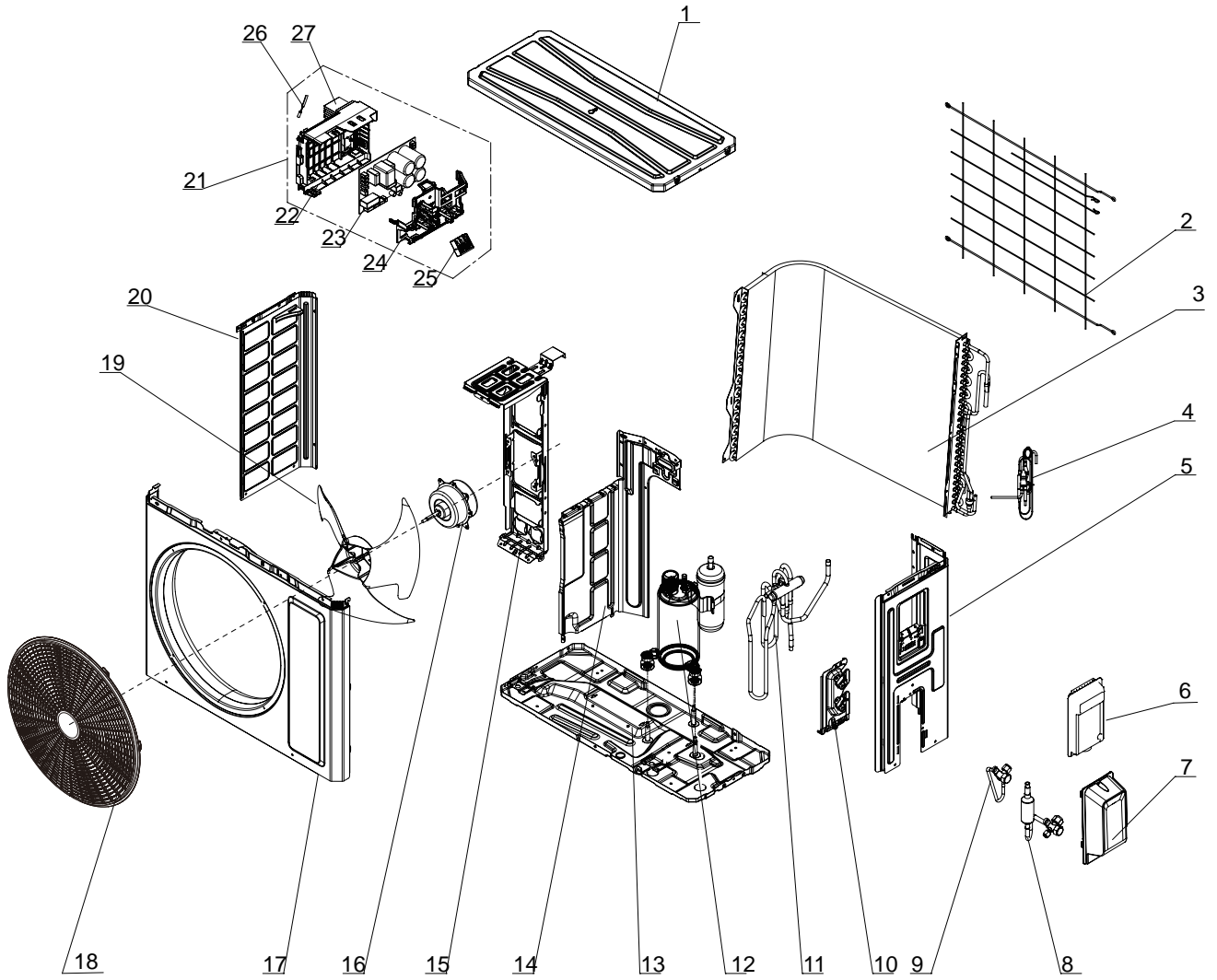

The component is only for reference; please refer to the actual product

NO.	Description	NO.	Description
1	Coping	15	Motor Support
2	Rear Grill	16	Brushless DC Motor
3	Condenser Assy	17	Cabinet
4	Capillary Sub-Assy	18	Front Grill
5	Right Side Plate	19	Axial Flow Fan
6	Cover of Pass Wire	20	Left Side Plate
7	Valve Cover	21	Electric Box Assy
8	Cut-off valve Sub-Assy	22	Electric Box
9	Cut-off valve	23	Main Board
10	Valve Support	24	Electric Box Cover
11	4-way valve assy	25	Terminal Board
12	Compressor and Fittings	26	Temperatue Sensor
13	Chassis Sub-Assy	27	Radiator
14	Clapboard		

Some models may not contain some parts, please refer to the actual product.



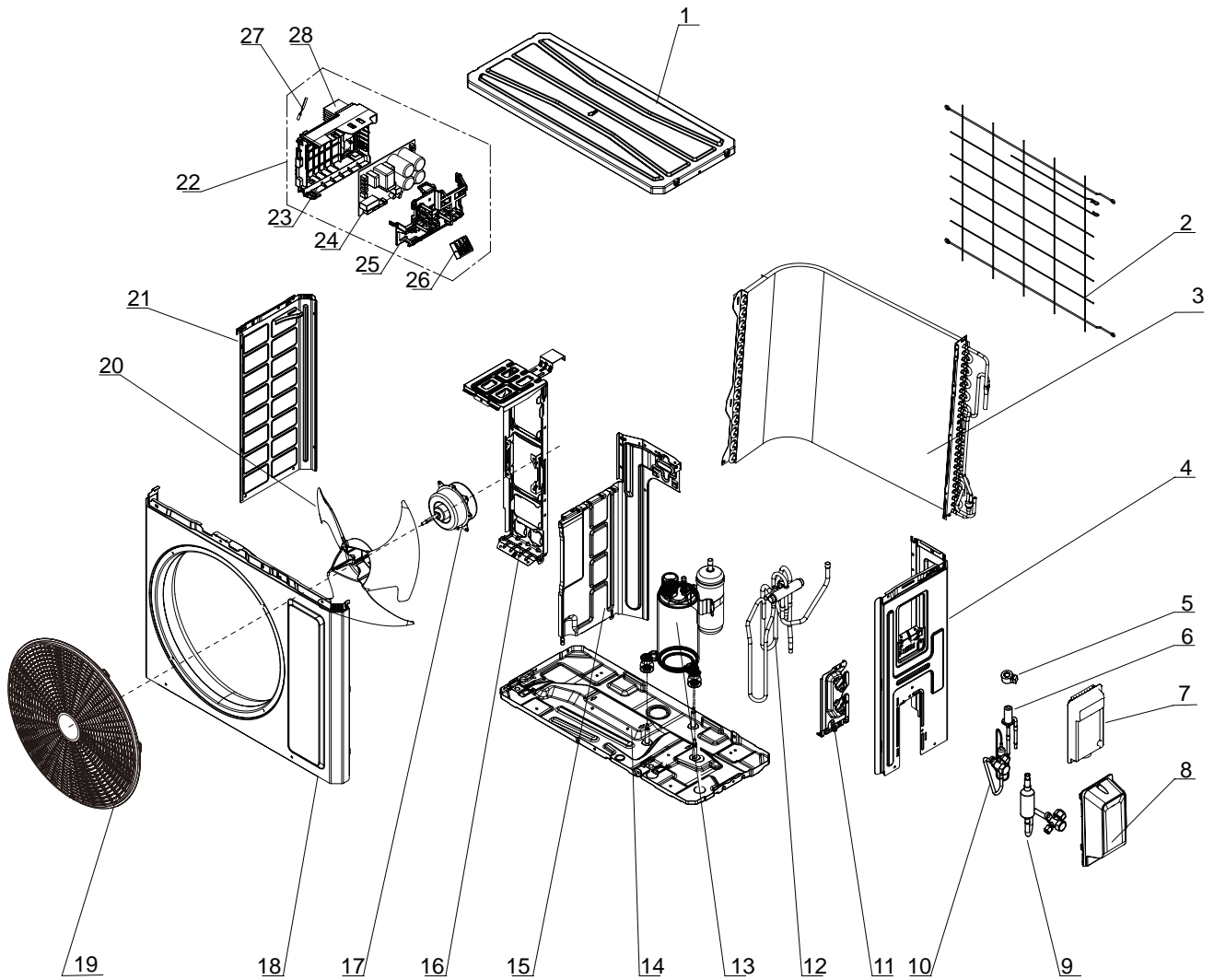

The component is only for reference; please refer to the actual product

NO.	Description	NO.	Description
1	Coping	15	Motor Support
2	Rear Grill	16	Brushless DC Motor
3	Condenser Assy	17	Cabinet
4	Right Side Plate	18	Front Grill
5	Electric Expand Valve Fitting	19	Axial Flow Fan
6	Electronic Expansion Valve	20	Left Side Plate
7	Valve Cover	21	Electric Box Assy
8	Cut-off valve Sub-Assy	22	Electric Box
9	Cut-off valve	23	Main Board
10	Valve Support	24	Electric Box Cover
11	4-way valve assy	25	Terminal Board
12	Compressor and Fittings	26	Temperatue Sensor
13	Chassis Sub-Assy	27	Radiator
14	Clapboard		

Some models may not contain some parts, please refer to the actual product.

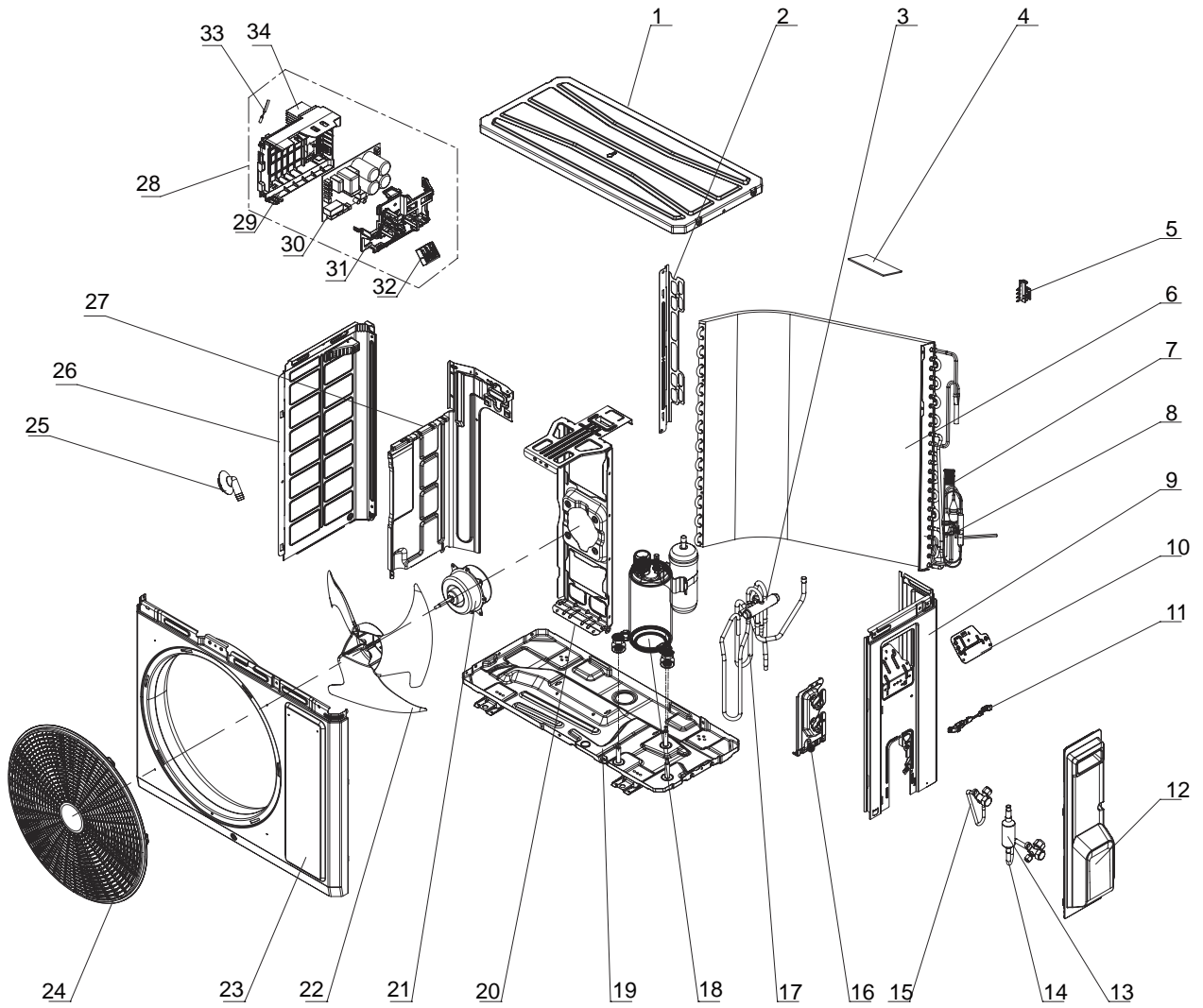

The component is only for reference; please refer to the actual product

NO.	Description	NO.	Description
1	Coping	18	Compressor and Fittings
2	Supporting Board(Condenser)	19	Chassis Sub-assy
3	4-Way Valve	20	Motor Support
4	Sponge(Condenser)	21	Brushless DC Motor
5	Temperature Sensor Support	22	Axial Flow Fan
6	Condenser Assy	23	Cabinet
7	Capillary Sub-assy	24	Front Grill
8	Sensor Insert	25	Drainage Joint(ODU)
9	Right Side Plate	26	Left Side Plate
10	Earthing Plate Sub-assy	27	Clapboard
11	Wire Clamp	28	Electric Box Assy
12	Handle Assy	29	Electric Box
13	Silencer	30	Main Board
14	Cut-off valve 1/4(N)	31	Electric Box Cover
15	Cut-off valve 3/8(N)	32	Terminal Board
16	Valve Support	33	Temperature Sensor
17	4-Way Valve Assy	34	Radiator

Some models may not contain some parts, please refer to the actual product.

GWH12YCXD-K6DNA1B/O

GWH18AFD-K6DNA2I/O

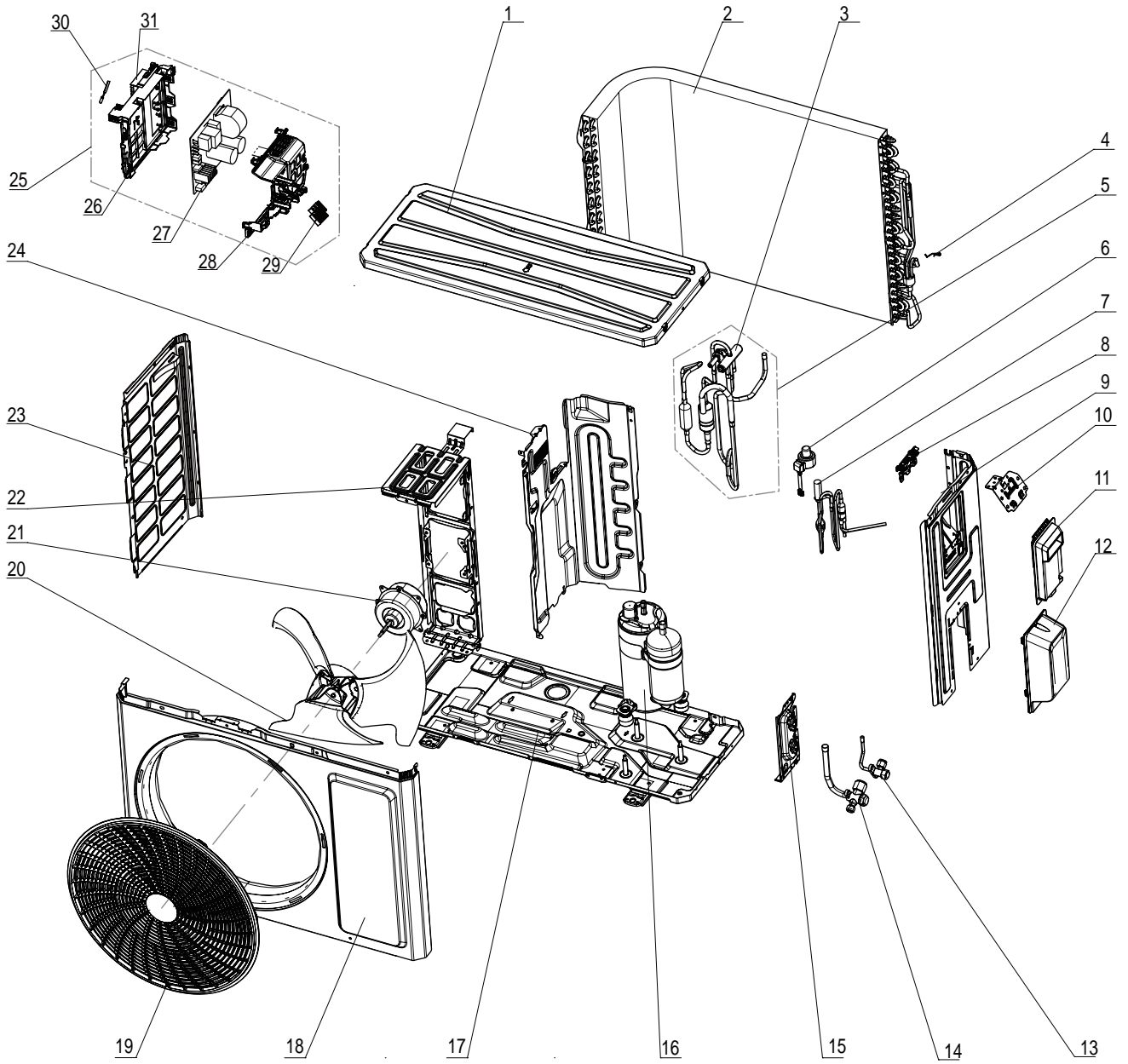

The component is only for reference; please refer to the actual product

NO.	Description	NO.	Description
1	Top Cover Assy	17	Chassis Sub-assy
2	Condenser Assy	18	Cabinet
3	4-Way Valve	19	Front Grill
4	Tempreture Sensor clamp	20	Axial Flow Fan
5	4-Way Valve Assy	21	Brushless DC Motor
6	Electric Expand Valve Fitting	22	Motor Support
7	Electric Expansion Valve Sub-Assy	23	Left Side Plate
8	Wire Clamp	24	Clapboard Assy
9	Right Side Plate	25	Electric Box Assy
10	Earthing Plate Sub-assy	26	Electric Box
11	Handle	27	Main Board
12	Valve Cover	28	Electric Box Cover
13	Cut-off valve 1/4(N)	29	Terminal Board
14	Cut-off valve 1/2(N)	30	Temperature Sensor
15	Valve Support	31	Radiator
16	Compressor and Fittings		

Some models may not contain some parts, please refer to the actual product.

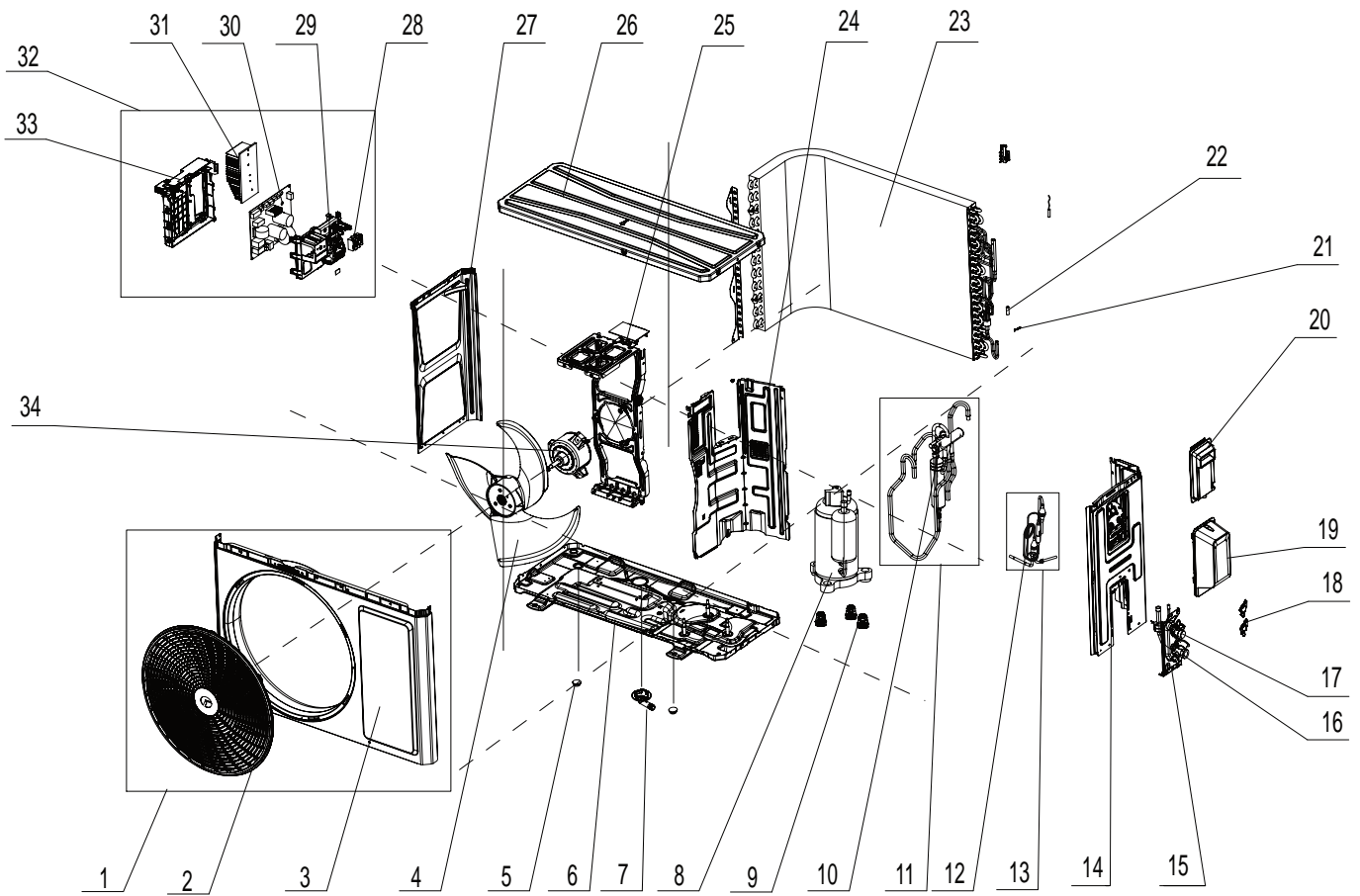

The component is only for reference; please refer to the actual product



NO.	Description	NO.	Description
1	Front Panel Assy	18	Valve Support Block
2	Front grill	19	Valve Cover
3	Front Panel	20	handle
4	Axial Flow Fan	21	Sensor Insert
5	Drainage hole Cap	22	Temp Sensor Sleeving
6	Chassis Sub-assy	23	Condenser Assy
7	Drainage Joint	24	Clapboard Sub-Assy
8	Compressor and Fittings	25	Motor Support Sub
9	Compressor Gasket	26	ITop Cover Sub-Assy
10	4-Way Valve	27	Left Side Plate
11	4-Way Valve Assy	28	Terminal Board
12	Capillary Tube	29	Electric Box Cover
13	Capillary Tube assy	30	Main Board
14	Right Side Plate Assy	31	Radiator
15	Valve Support	32	Electric Box Assy
16	Cut-off valve 1/2(N)	33	IElectric Box
17	Cut-off valve 1/4(N)	34	Brushless DC Motor

Some models may not contain some parts, please refer to the actual product.

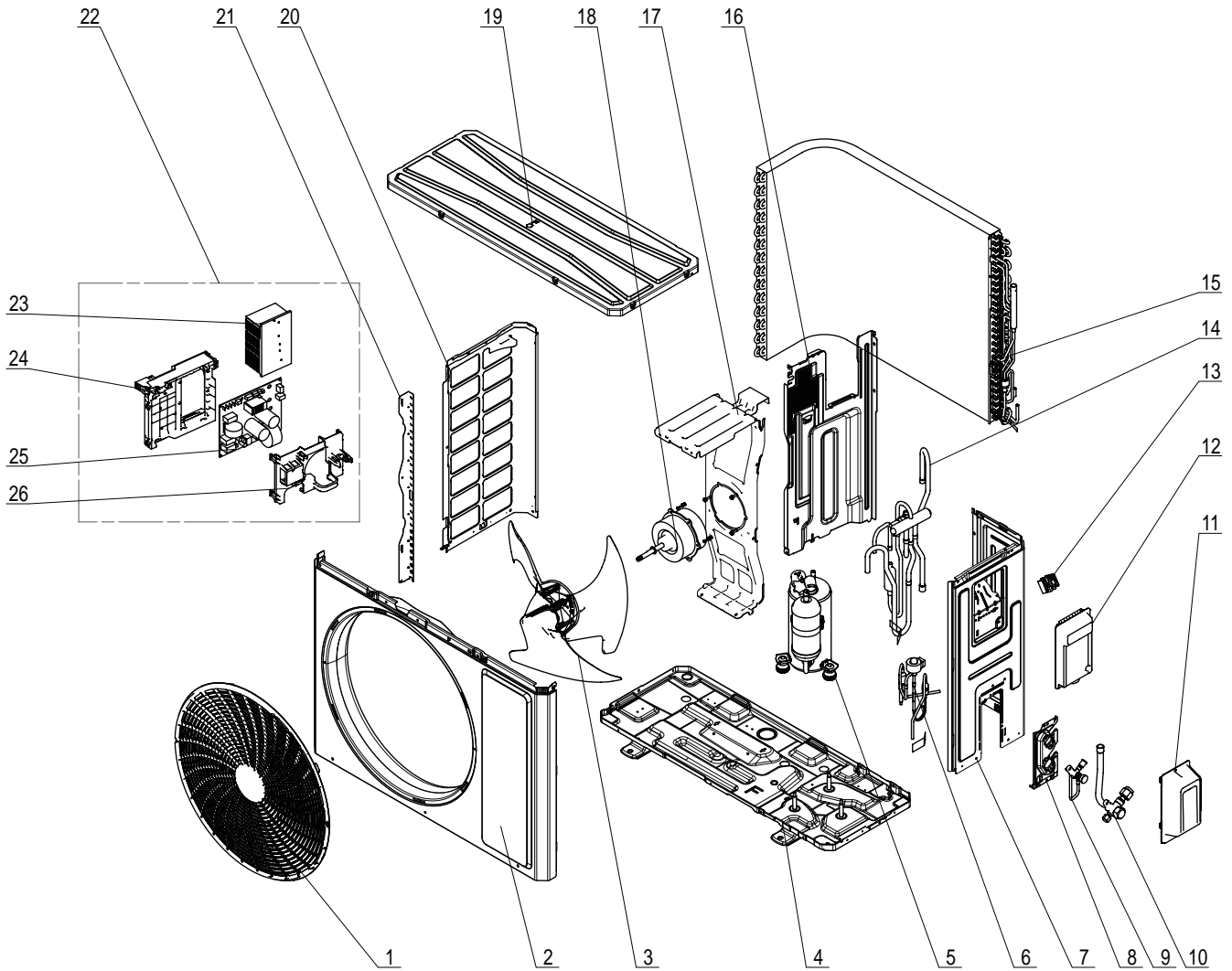

The component is only for reference; please refer to the actual product

NO.	Description	NO.	Description
1	Front Grill	14	4-Way Valve Assy
2	Front Panel	15	Condenser Assy
3	Axial Flow Fan	16	Clapboard Assy
4	Chassis Sub-assy	17	Motor Support
5	Compressor and Fittings	18	Brushless DC Motor
6	Electronic Expansion Valve Assy	19	Top Cover Assy
7	Right Side Plate	20	Left Side Plate
8	Valve Support	21	Condenser Left Border Plate
9	Cut-off valve 1/4(N)	22	Electric Box Assy
10	Cut-off valve 5/8(N)	23	Radiator
11	Valve Cover	24	Electric Box
12	Handle	25	Main Board
13	Terminal Board	26	Electric Box Cover

Some models may not contain some parts, please refer to the actual product.

# 11. Removal Procedure



## 11.1 Removal Procedure of Indoor Unit



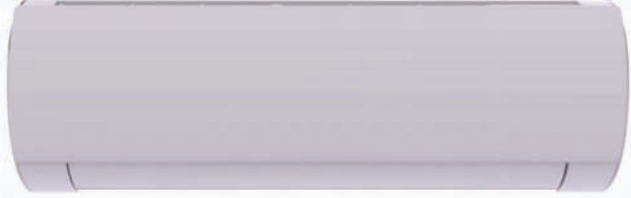
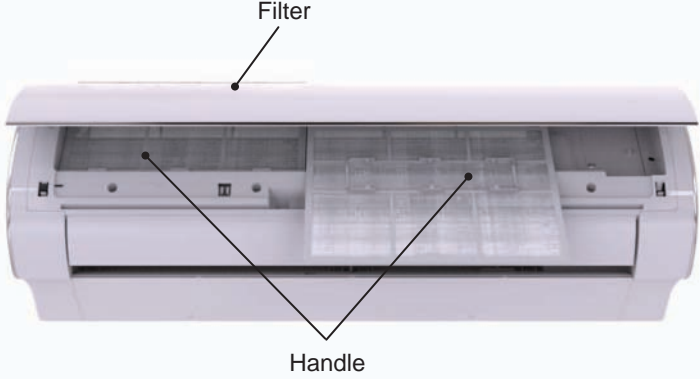
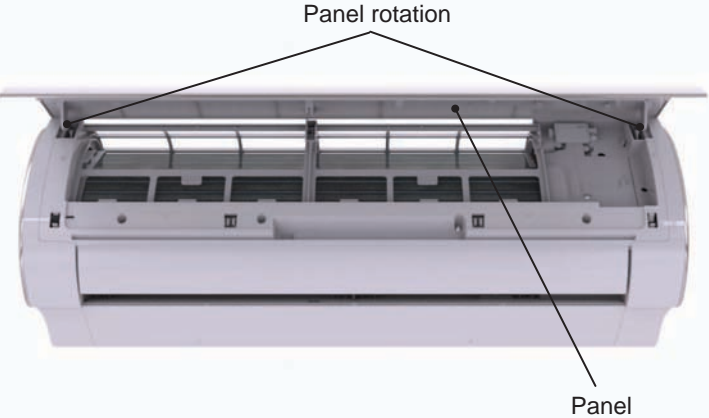

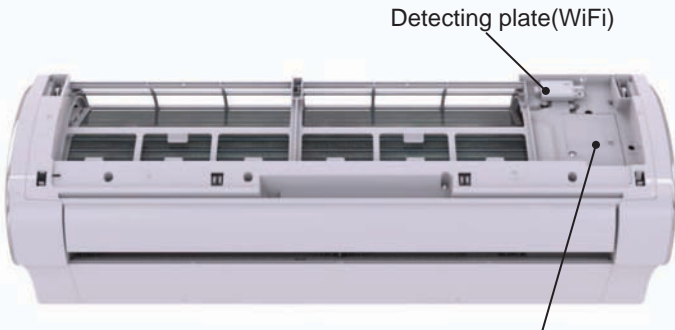
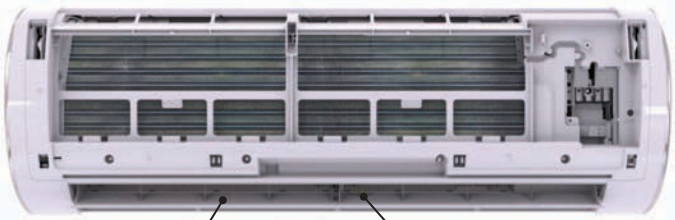
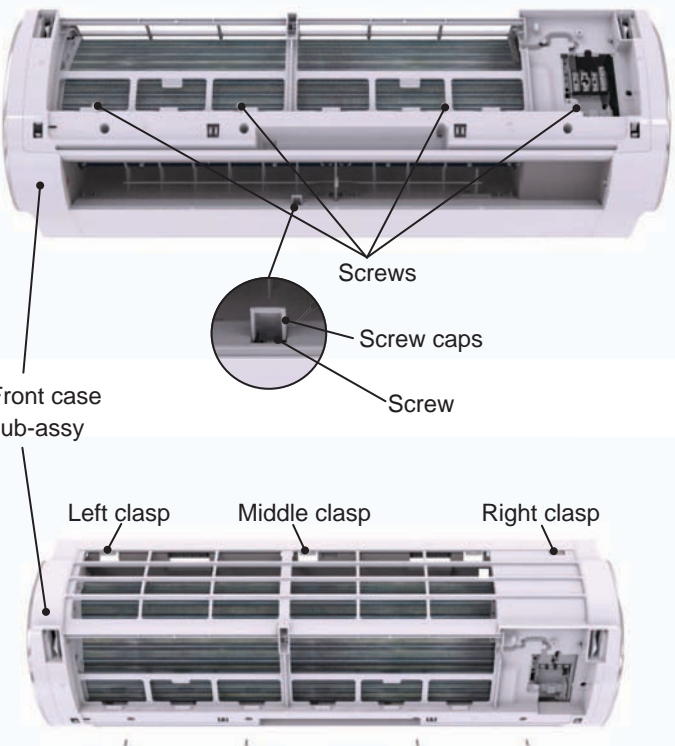
Caution: discharge the refrigerant completely before removal.

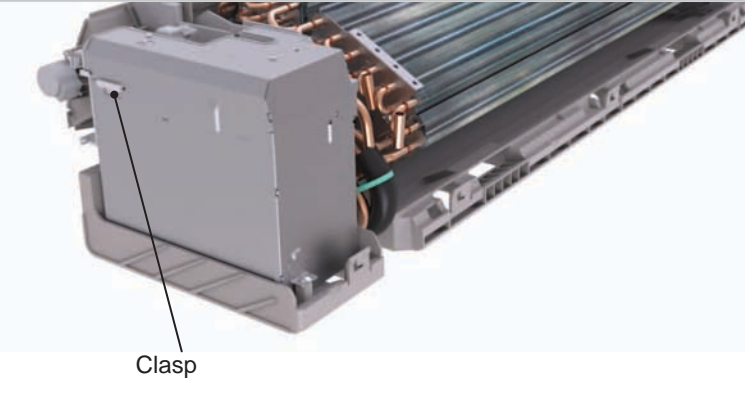
Step	Procedure	Procedure
Before disassemble	Turn off the air conditioner and disconnect the power before disassemble the air conditioner.	
1. Remove filter	Open the front panel; Push the filter upwards to loosen the clasp and then pull the left filter and right filter outwards to remove them.	
2. Remove front panel	Separate the panel rotation shaft from the groove fixing the front panel and then removes the front panel.  Note: The display of some models is fixed on the panel; unscrew the screws fixing the display on the panel before removing the panel.	

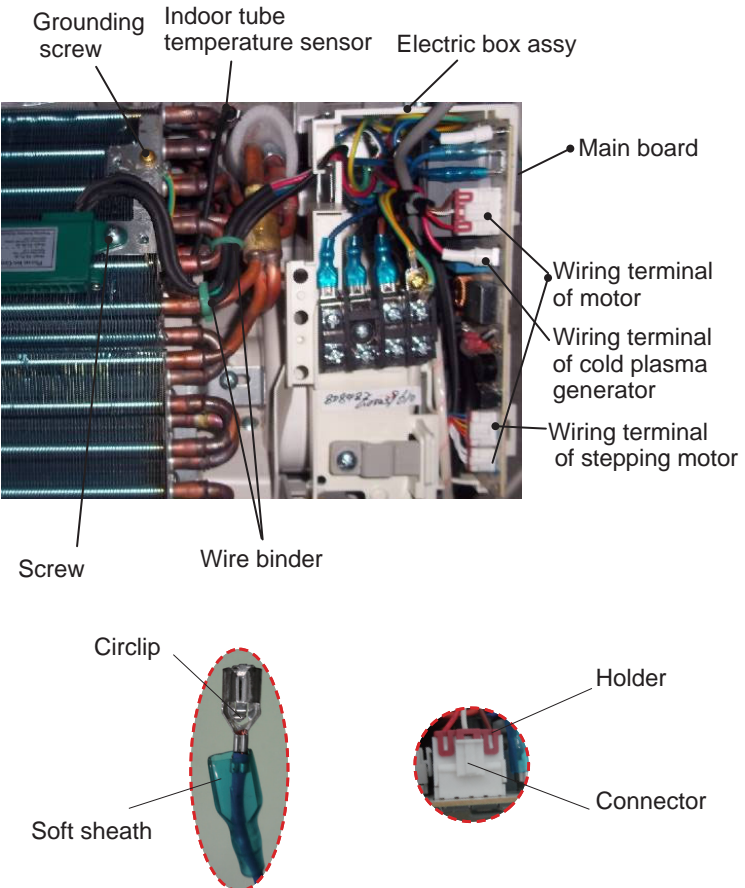
Step	Procedure	Image
3.Remove electric box cover sub-assy2 and detecting plate(wifi)	<p>Remove the screws on the electric box cover sub-assy2 and detecting plate(WIFI), to remove the electric box cover 2 and detecting plate(WIFI).</p>	 <p>Labels: Detecting plate(WiFi), Electric box cover sub-assy2</p>
4.Remove horizontal louver	<p>Push out the axle bush on horizontal louver. Bend the horizontal louver with hand and then separate the horizontal louver from the crankshaft of step motor to remove it.</p>	 <p>Labels: Horizontal louver, Axile bush</p>
5.Remove front case sub-assy	<p>a Remove the screws fixing front case.</p> <p>Note:  (1) Open the screw caps before removing the screws around the air outlet.  (2) The quantity of screws fixing the front case sub-assy is different for different models.</p> <p>b Loosen the clasps at left, middle and right sides of front case. Lift the front case sub-assy upwards to remove it.</p>	 <p>Labels: Front case sub-assy, Left clasp, Middle clasp, Right clasp, Screws, Screw caps, Screw</p>

Step	Procedure	Procedure
6.Remove electric box cover sub-assy	Loosen the clasps and remove the electric box cover sub-assy.	
7.Remove electric box assy	<p>a Remove the screw fixing electric box assy.</p> <p>b</p> <ol style="list-style-type: none"> <li>① Cut off the wire binder and pull out the indoor tube temperature sensor.</li> <li>② Screw off one grounding screw.</li> <li>③ Remove the wiring terminals of motor, cold plasma generator and stepping motor.</li> <li>④ Remove the electric box assy.</li> <li>⑤ Screw off the screws that are locking each.</li> </ol>	
C	<p>Remove the wiring terminal of power cord. Lift up the main board and take it off.</p> <p>Instruction:Some wiring terminal of this products is with lock catch and other devices.The pulling method is as below:</p> <ol style="list-style-type: none"> <li>1.Remove the soft sheath for some terminals at first, hold the circlip and then pull out the terminals,</li> <li>2.Pull out the holder for some terminals at first(holder is not available for some wiring terminal).hold the connector and then pull the terminal.</li> </ol>	

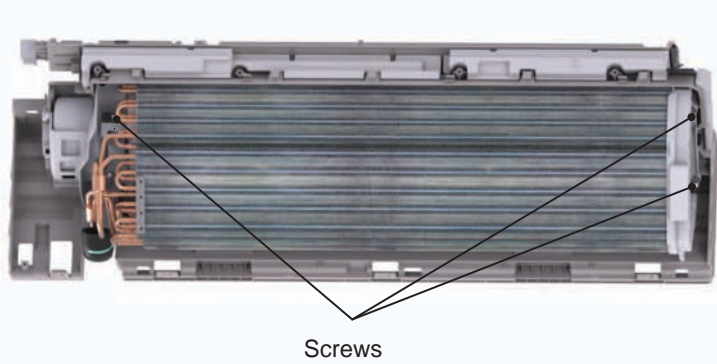

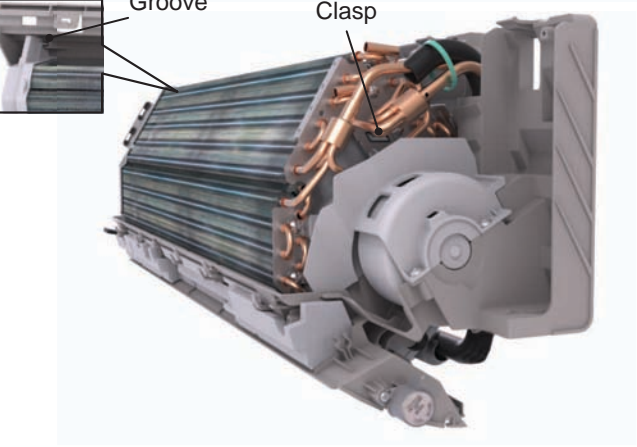
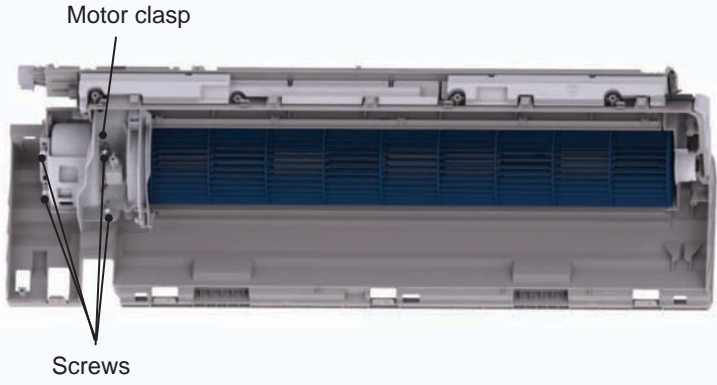
Step	Procedure
<b>8.Remove evaporator assy</b>	
a	<p>Remove 3 screws fixing evaporator assy.</p>  <p style="text-align: center;">Screws</p>
b	<p>At the back of the unit, remove the screw of the connection pipe clamp and then remove the connection pipe clamp.</p>  <p style="text-align: center;">Screw Connection pipe clamp</p>
c	<p>First remove the left side of evaporator from the groove of bottom shell and then remove the right side from the clasp on the bottom shell. Adjust the position of connection pipe on evaporator slightly and then lift the evaporator upwards to remove it.</p>  <p style="text-align: center;">Groove Clasp</p>
<b>9.Remove motor and cross flow blade</b>	
a	<p>Remove the screws fixing motor clamp and then remove the motor clamp.</p>  <p style="text-align: center;">Motor clamp Screws</p>



Step	Procedure	Procedure
b	Loose the screws (2-3 circles) used for fixing the cross flow fan, pull right to pull out the motor.	 <p data-bbox="1333 508 1403 537">Screw</p>

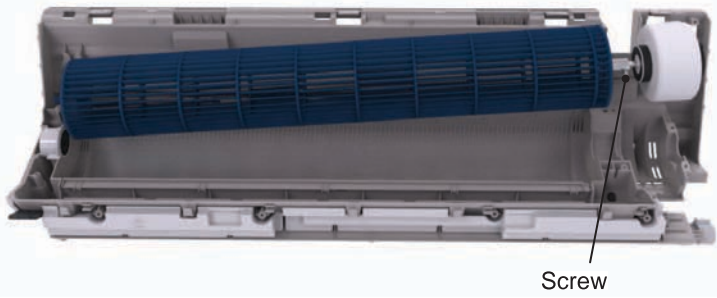



Screw

## 11.2 Removal Procedure of Outdoor Unit

GWH07AGA-K6DNA1A/O

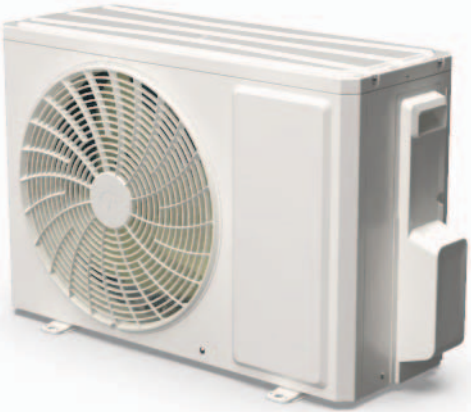

**Caution: discharge the refrigerant completely before removal.**

Step	Procedure
<b>1. Before disassembly</b>	
<b>2. Remove handle</b>	<p data-bbox="191 1148 789 1214">Remove the screws fixing handle and then remove them.</p> 
<b>3. Remove top cover</b>	<p data-bbox="191 1749 789 1814">Remove the screws fixing top panel and then remove the top panel.</p> 

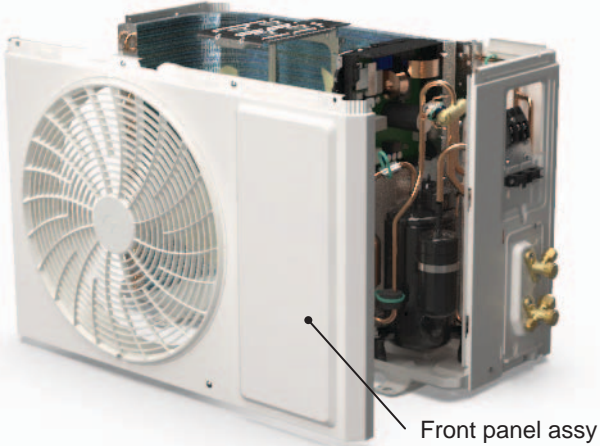
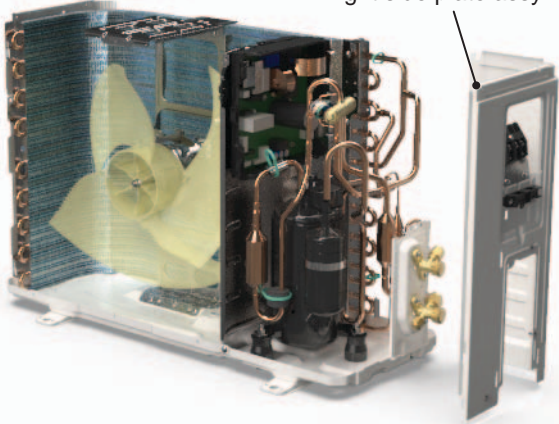
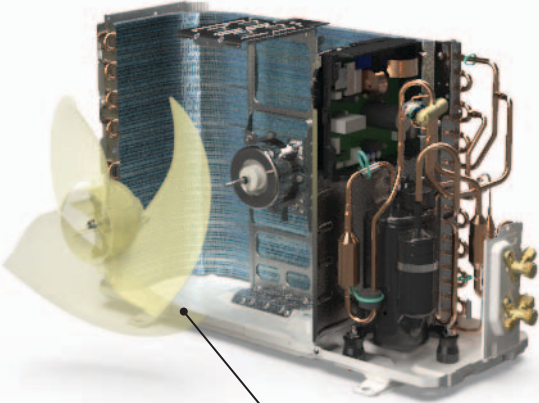
Step	Procedure
<p><b>4. Remove front panel assy</b></p>	<p>Remove connection screws connecting the front panel assy with the chassis and the motor support, and then remove the front panel assy.</p> 
<p><b>5. Remove right side plate assy</b></p>	<p>Rescrew the ground screws, remove the ground wires, loosen the screws fixing terminal board, remove the terminal board, rescrew the screws fixing the right plate, and remove the right side plate assy.</p> 
<p><b>6. Remove axial flow fan</b></p>	<p>Remove the nut on the fan and then remove the axial flow fan.</p> 

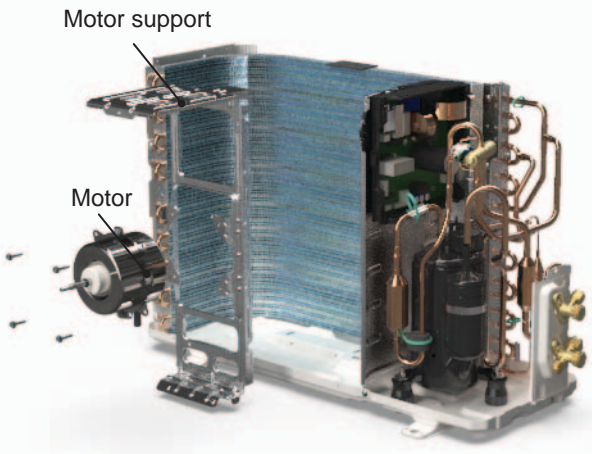
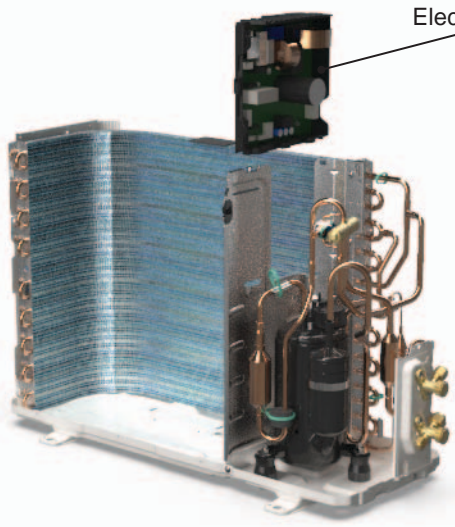
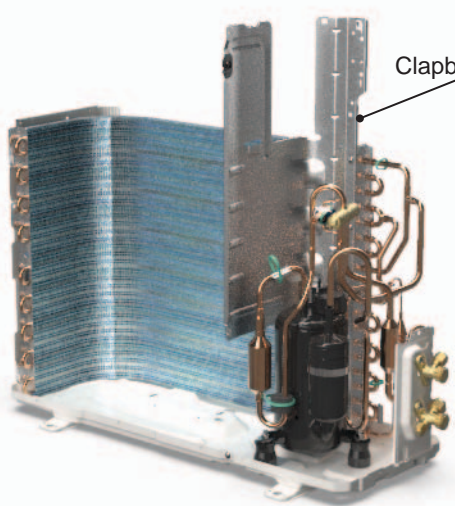

Step	Procedure
<p><b>7. Remove motor support and motor</b></p>	<p>Remove the screws fixing the motor support and lift the motor support to remove it. Remove the screws fixing the motor and then remove the motor.</p> 
<p><b>8. Remove electric box assy</b></p>	<p>Remove the terminals, lift up and rotate the electrical box assy to the right so that the snaps on the clapboard are removed and the electrical box assy are removed.</p> 
<p><b>9. Remove clapboard assy</b></p>	<p>Remove the screws fixing the clapboard assy and then remove the clapboard assy.</p> 

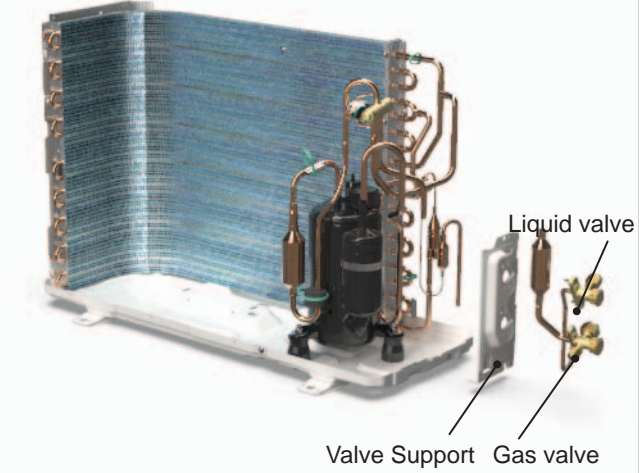
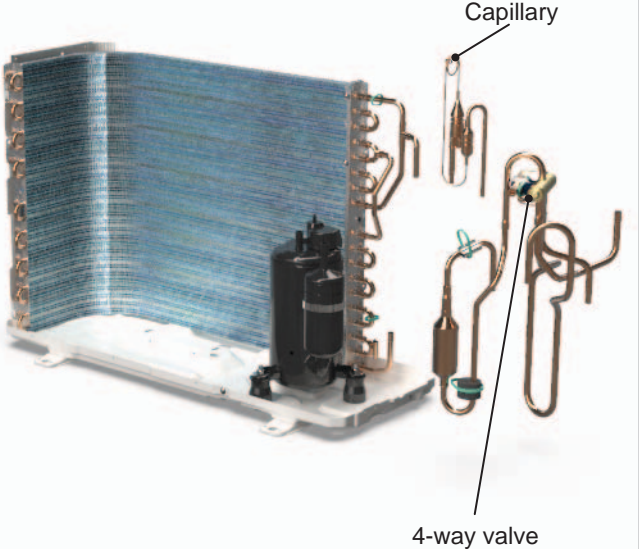
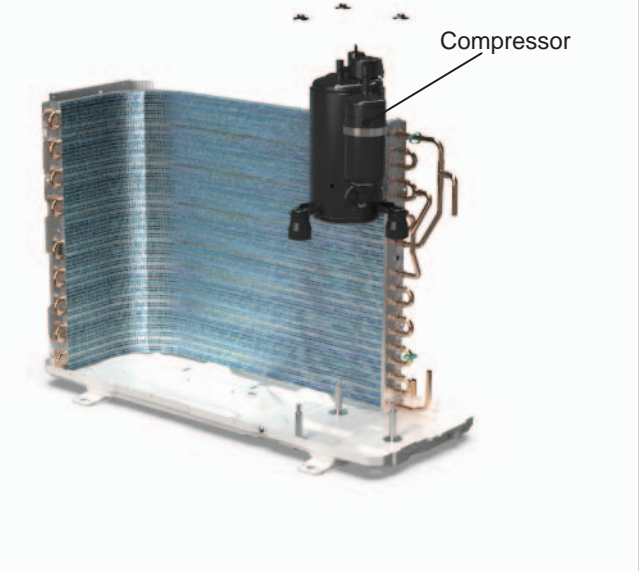

Step	Procedure
<p><b>10. Remove gas valve and liquid valve</b></p> <p>Remove the valve support block, remove the screws fixing the gas valve and the liquid valve, unsolder the welding joint connecting the gas valve and the liquid valve, remove them.</p> <p>Note: Discharge the refrigerant completely before unsoldering; when unsoldering, wrap the gas valve with a wet cloth completely to avoid damage to the valve caused by high temperature.</p>	 <p>The diagram shows a refrigerant system with a condenser coil on the left and a compressor at the bottom. On the right, there is a valve support block. A liquid valve and a gas valve are connected to this support block. Arrows point from the labels 'Liquid valve', 'Valve Support', and 'Gas valve' to their respective parts in the diagram.</p>
<p><b>11. Remove 4-way valve and capillary</b></p> <p>Unsolder the welding joints connecting capillary, and then remove it.</p> <p>Unsolder the welding joints connecting the 4-way valve assembly with capillary sub-assembly, compressor and condenser; remove the 4-way valve. Cooling only unit removes Discharge Tube and Inhalation Tube.</p> <p>Note: Before unsoldering the welding joint, wrap the 4-way valve with a wet cloth completely to avoid damage to the valve caused by high temperature.</p>	 <p>The diagram shows the same refrigerant system as in step 10. A capillary tube and a 4-way valve are highlighted. Arrows point from the labels 'Capillary' and '4-way valve' to their respective parts in the diagram.</p>
<p><b>12. Remove compressor</b></p> <p>Remove the 3 foot nuts on the compressor and then remove the compressor.</p>	 <p>The diagram shows the refrigerant system with the compressor highlighted. An arrow points from the label 'Compressor' to the compressor unit in the diagram.</p>



**Caution: discharge the refrigerant completely before removal.**

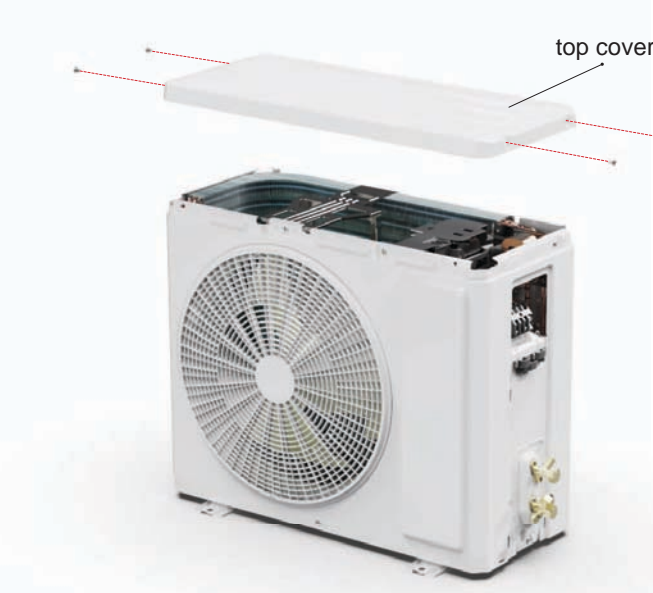

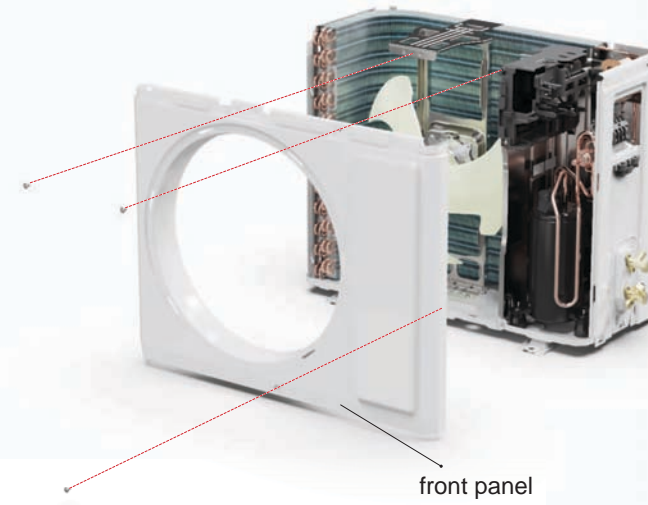
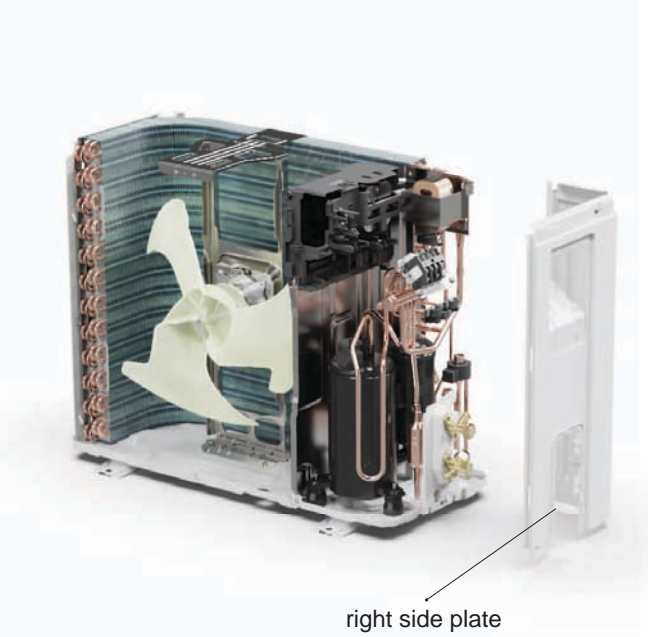
Step	Procedure
<p><b>1. Before disassembly</b></p>	
<p><b>2. Remove big handle and valve cover</b></p>	<p>Remove the connection screw fixing the big handle and then remove the valve cover.</p> 
<p><b>3. Remove top cover</b></p>	<p>Remove connection screws connecting the top panel with the front panel and the right side plate, and then remove the top panel.</p> 

Step	Procedure
<p><b>4. Remove grille</b></p>	<p>Remove connection screws between the front grille and the front panel. Then remove the grille.</p> 
<p><b>5. Remove front panel</b></p>	<p>Remove connection screws connecting the front panel with the chassis and the motor support and then remove the front panel.</p> 
<p><b>6. Remove right side plate</b></p>	<p>Remove connection screws connecting the right side plate with the valve support and the electric box. Then remove the right side plate.</p> 

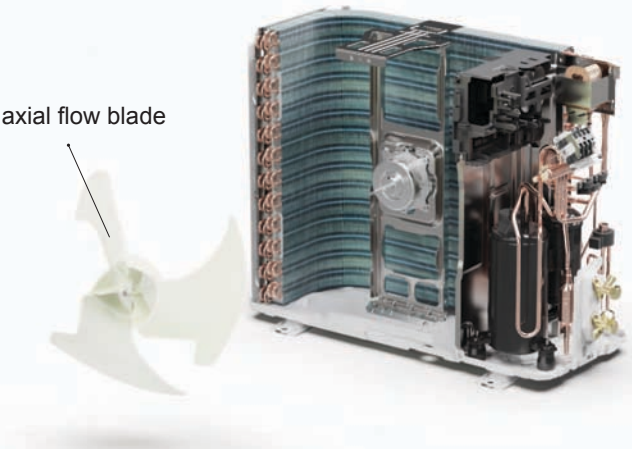
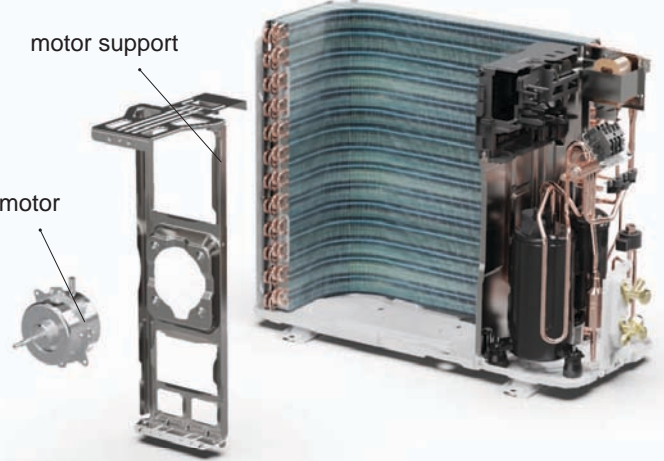
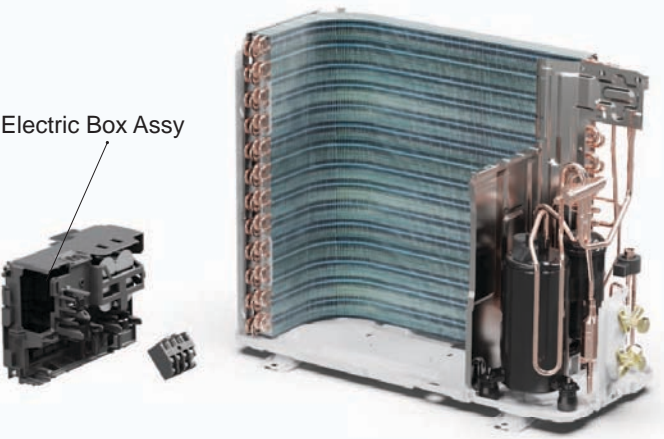

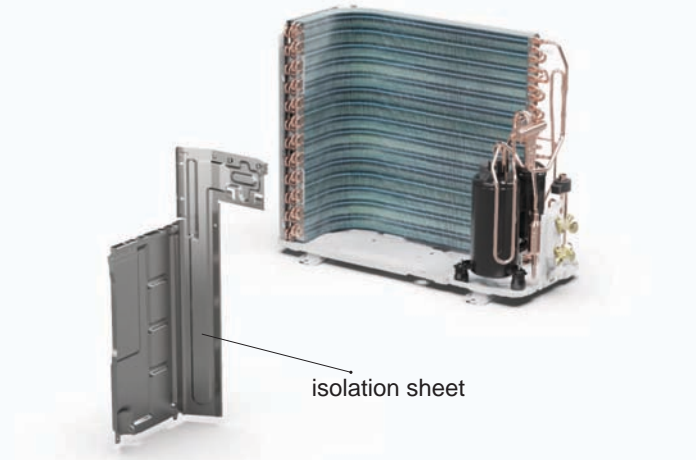
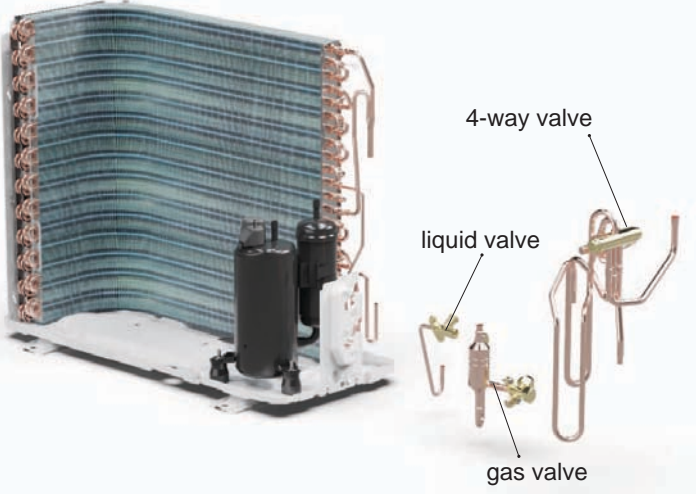
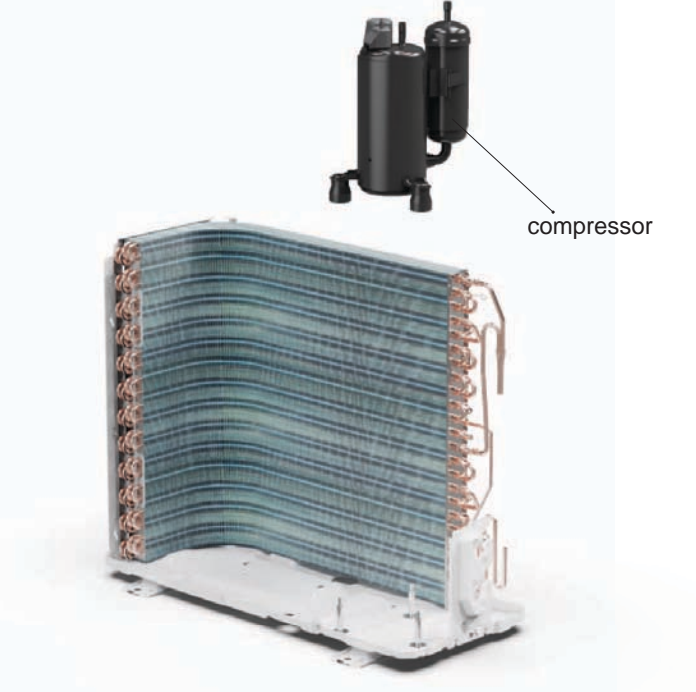
Step	Procedure
<p><b>7. Remove axial flow blade</b></p>	<p>Remove the nut on the blade and then remove the axial flow blade.</p> 
<p><b>8. Remove motor and motor support</b></p>	<p>Remove the tapping screws fixing the motor and disconnect the leading wire insert of the motor. Then remove the motor. Remove the tapping screws fixing the motor support and lift the motor support to remove it.</p> 
<p><b>9. Remove Electric Box Assy</b></p>	<p>Remove screws fixing the electric box subassembly; loosen the wire bundle and unplug the wiring terminals. Then lift the electric box to remove it.</p> 

Step	Procedure
<b>10. Remove isolation sheet</b>	
	<p>Remove the screws fixing the isolation sheet and then remove the isolation sheet.</p>  <p>The diagram shows a condenser coil assembly with a black metal isolation sheet partially removed. A label 'isolation sheet' points to the sheet being lifted away from the coil.</p>
<b>11. Remove compressor</b>	
a	<p>Unsolder the welding joint connecting the capillary, valves and the outlet pipe of condenser to remove the capillary. Do not block the capillary with welding slag during unsoldering.</p>
b	<p>Remove the 2 screws fixing the gas valve and unsolder the welding joint between the gas valve and the air-return pipe to remove the gas valve. (NOTE: Discharge the refrigerant completely before unsoldering; when unsoldering, wrap the gas valve with a wet cloth completely to avoid damage to the valve caused by high temperature).</p> <p>Remove the 2 screws fixing the liquid valve and unsolder the welding joint connecting the liquid valve to the Y-type pipe to remove the liquid valve.</p>  <p>The diagram shows the condenser coil assembly with the gas valve and liquid valve removed. Labels point to the '4-way valve', 'liquid valve', and 'gas valve'.</p>
c	<p>Unsolder pipes connecting with compressor.</p>
d	<p>Remove the 3 foot nuts on the compressor and then remove the compressor.</p>  <p>The diagram shows the condenser coil assembly with the compressor removed. A label 'compressor' points to the black cylindrical component.</p>

Step	Procedure
<b>1. Before disassembly</b>	
<b>2. Remove big handle and valve cover</b>	<p>Remove the screws fixing big handle, valve cover and then remove them.</p> 
<b>3. Remove top cover</b>	<p>Remove the screws fixing top panel and then remove the top panel.</p> 

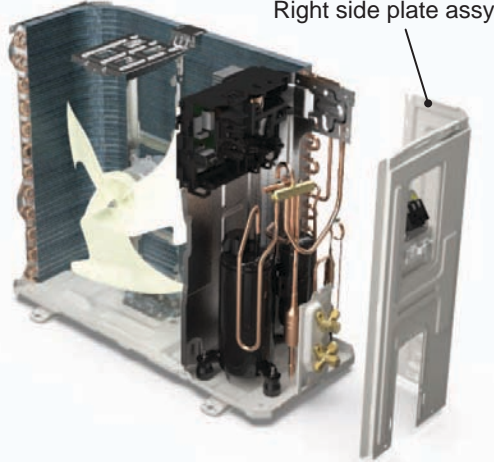
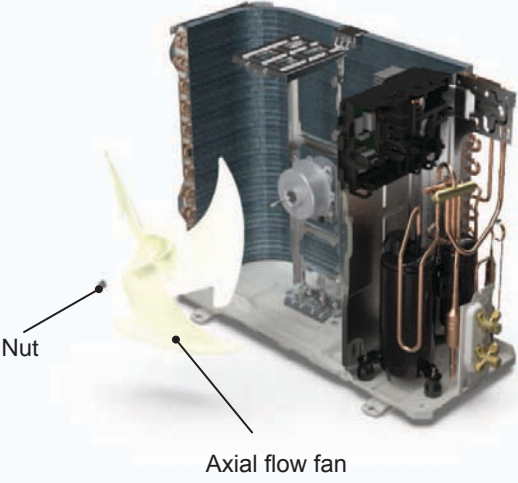
Step	Procedure
<p><b>4. Remove front panel assy</b></p>	<p>Remove connection screws connecting the front panel assy with the chassis and the motor support, and then remove the front panel assy.</p> 
<p><b>5. Remove right side plate assy</b></p>	<p>Rescrew the ground screws, remove the ground wires, loosen the screws fixing terminal board, remove the terminal board, rescrew the screws fixing the right plate, and remove the right side plate assy.</p> 
<p><b>6. Remove axial flow fan</b></p>	<p>Remove the nut on the fan and then remove the axial flow fan.</p> 



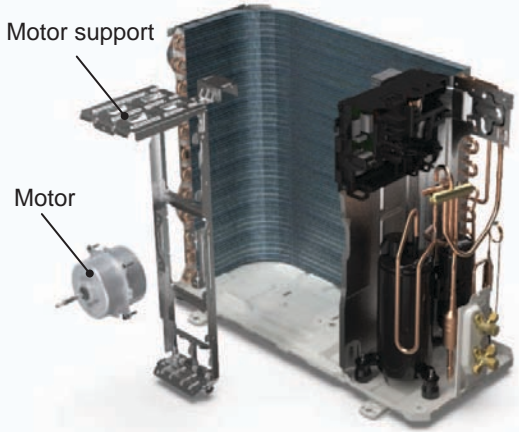
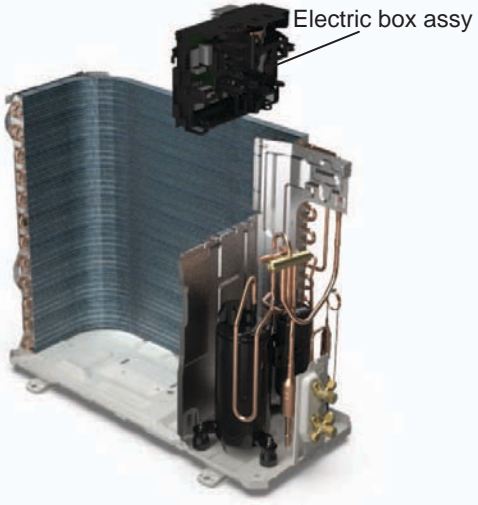
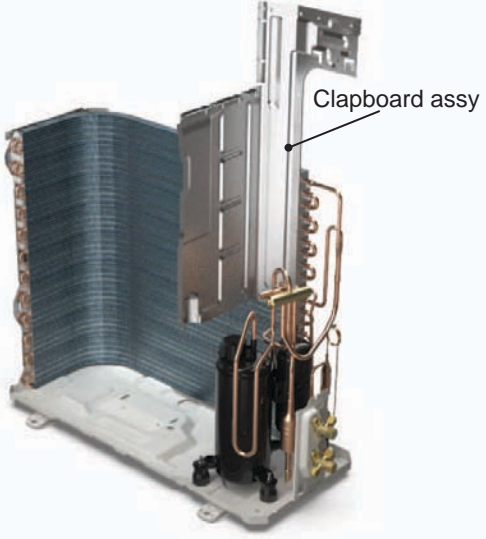

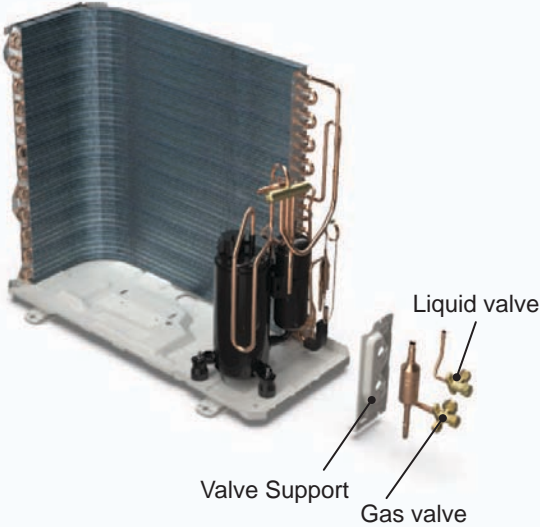
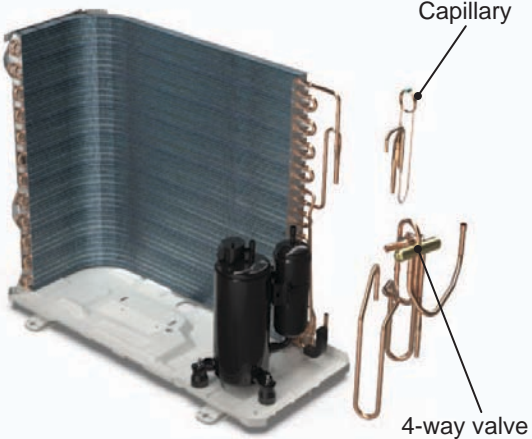
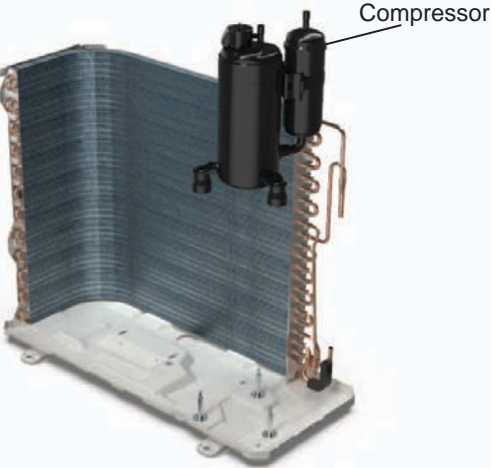
Step	Procedure
<p><b>7. Remove motor support and motor</b></p>	<p>Remove the screws fixing the motor support and lift the motor support to remove it. Remove the screws fixing the motor and then remove the motor.</p> 
<p><b>8. Remove electric box assy</b></p>	<p>Remove the terminals, lift up and rotate the electrical box assy to the right so that the snaps on the clapboard are removed and the electrical box assy are removed.</p> 
<p><b>9. Remove clapboard assy</b></p>	<p>Remove the screws fixing the clapboard assy and then remove the clapboard assy.</p> 

Step	Procedure
<p><b>10. Remove gas valve and liquid valve</b></p> <p>Remove the valve support block, remove the screws fixing the gas valve and the liquid valve, unsolder the welding joint connecting the gas valve and the liquid valve, remove them.</p> <p>Note: Discharge the refrigerant completely before unsoldering; when unsoldering, wrap the gas valve with a wet cloth completely to avoid damage to the valve caused by high temperature.</p>	
<p><b>11. Remove 4-way valve and capillary</b></p> <p>Unsolder the welding joints connecting capillary, and then remove it.</p> <p>Unsolder the welding joints connecting the 4-way valve assembly with capillary sub-assembly, compressor and condenser; remove the 4-way valve. Cooling only unit removes Discharge Tube and Inhalation Tube.</p> <p>Note: Before unsoldering the welding joint, wrap the 4-way valve with a wet cloth completely to avoid damage to the valve caused by high temperature.</p>	
<p><b>12. Remove compressor</b></p> <p>Remove the 3 foot nuts on the compressor and then remove the compressor.</p>	



**Caution: discharge the refrigerant completely before removal.**



Step	Procedure
<p><b>1. Before disassembly</b></p>	
<p><b>2. Remove big handle and valve cover</b></p>	<p>Remove the screws fixing big handle, valve cover and then remove them.</p> 
<p><b>3. Remove top cover</b></p>	<p>Remove the screws fixing top panel and then remove the top panel.</p> 

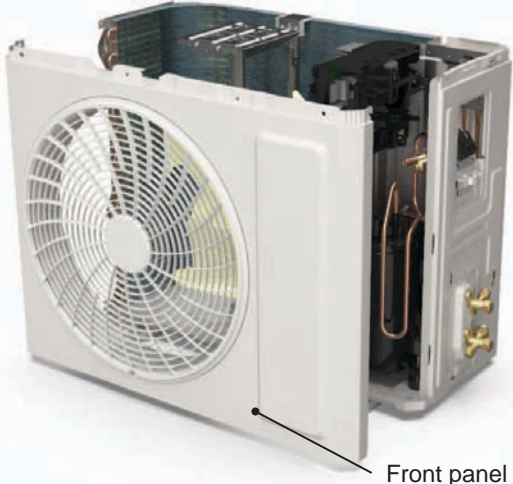
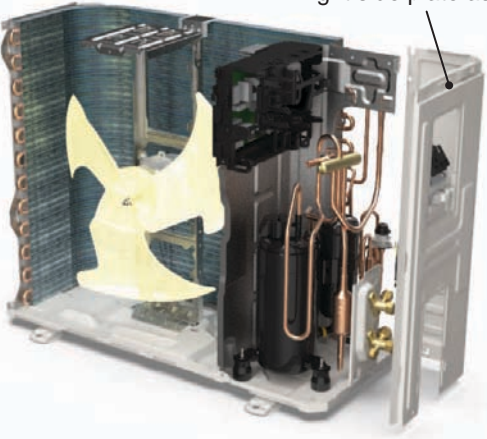
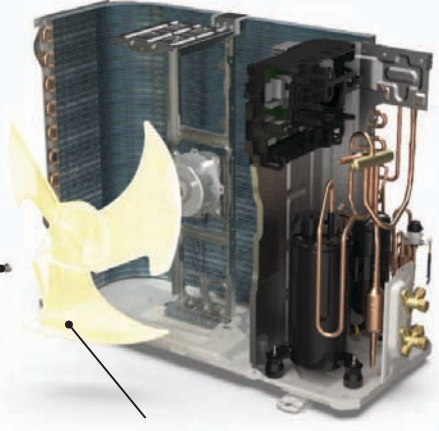

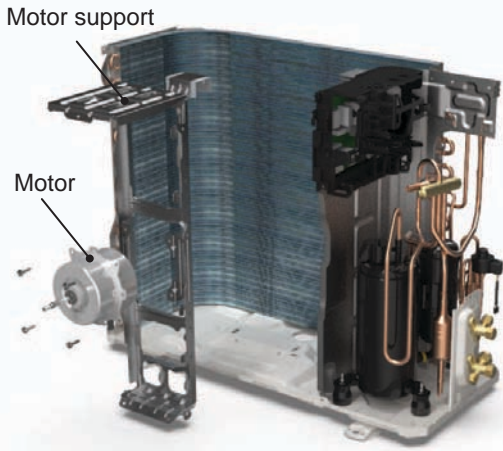
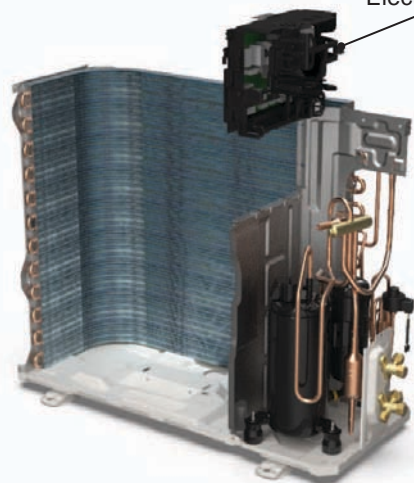
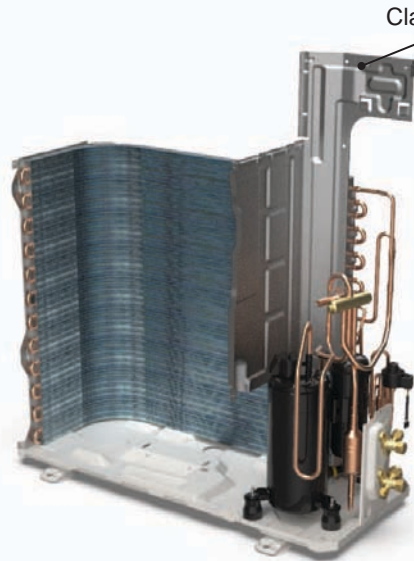
Step	Procedure
<p><b>4. Remove front panel assy</b></p>	<p>Remove connection screws connecting the front panel assy with the chassis and the motor support, and then remove the front panel assy.</p>  <p>Front panel assy</p>
<p><b>5. Remove right side plate assy</b></p>	<p>Rescrew the ground screws, remove the ground wires, loosen the screws fixing terminal board, remove the terminal board, rescrew the screws fixing the right plate, and remove the right side plate assy.</p>  <p>Right side plate assy</p>
<p><b>6. Remove axial flow fan</b></p>	<p>Remove the nut on the fan and then remove the axial flow fan.</p>  <p>Nut</p> <p>Axial flow fan</p>

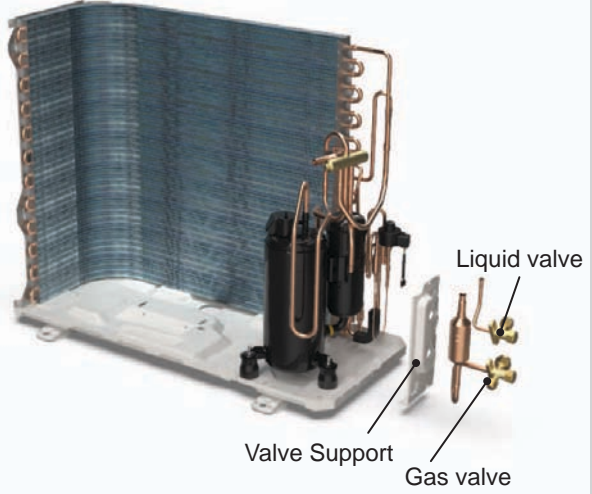
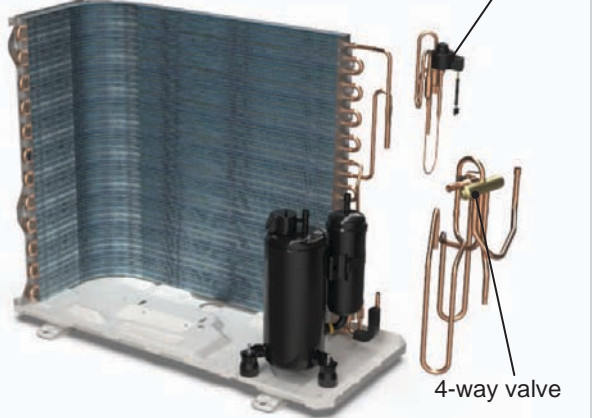
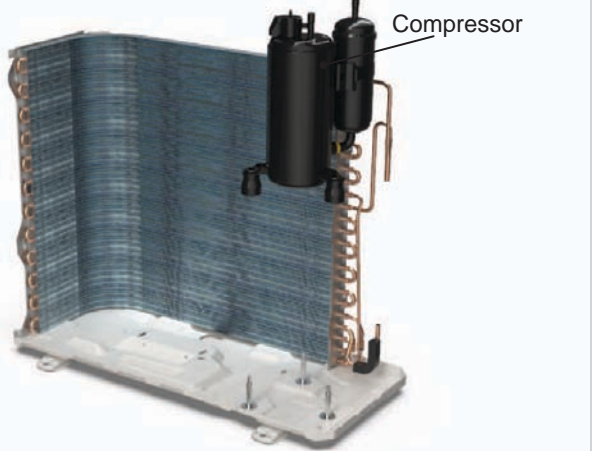
Step	Procedure
<p><b>7. Remove motor support and motor</b></p>	<p>Remove the screws fixing the motor support and lift the motor support to remove it. Remove the screws fixing the motor and then remove the motor.</p> 
<p><b>8. Remove electric box assy</b></p>	<p>Remove the terminals, lift up and rotate the electrical box assy to the right so that the snaps on the clapboard are removed and the electrical box assy are removed.</p> 
<p><b>9. Remove clapboard assy</b></p>	<p>Remove the screws fixing the clapboard assy and then remove the clapboard assy.</p> 

Step	Procedure
<p><b>10. Remove gas valve and liquid valve</b></p> <p>Remove the valve support block, remove the screws fixing the gas valve and the liquid valve, unsolder the welding joint connecting the gas valve and the liquid valve, remove them.</p> <p>Note: Discharge the refrigerant completely before unsoldering; when unsoldering, wrap the gas valve with a wet cloth completely to avoid damage to the valve caused by high temperature.</p>	 <p>Liquid valve</p> <p>Gas valve</p> <p>Valve Support</p>
<p><b>11. Remove 4-way valve and electric expansion valve sub-Assy</b></p> <p>Unsolder the welding joints connecting the 4-way valve assy, remove the 4-way valve.</p> <p>Unsolder the spot weld of electric expansion valve sub-Assy and condenser, and then remove the electric expansion valve sub-Assy.</p> <p>Note: Before unsoldering the welding joint, wrap the 4-way valve with a wet cloth completely to avoid damage to the valve caused by high temperature. When unsoldering the spot weld, wrap the electric expansion valve sub-Assy with wet cloth completely to avoid damaging the valve due to high temperature.</p>	 <p>Electric expansion valve sub-Assy</p> <p>4-way valve</p>
<p><b>12. Remove compressor</b></p> <p>Remove the 3 foot nuts on the compressor and then remove the compressor.</p>	 <p>Compressor</p>

Step	Procedure
<p><b>1. Before disassembly</b></p>	
<p><b>2. Remove big handle and valve cover</b></p>	<p>Remove the screws fixing big handle, valve cover and then remove them.</p> 
<p><b>3. Remove top cover</b></p>	<p>Remove the screws fixing top panel and then remove the top panel.</p> 

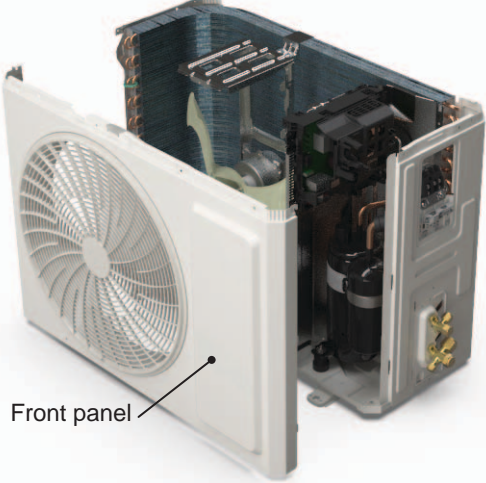
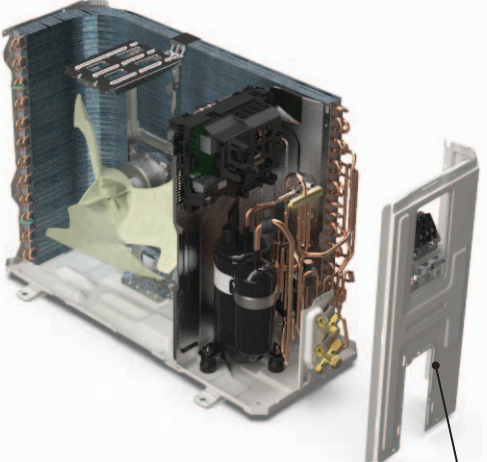
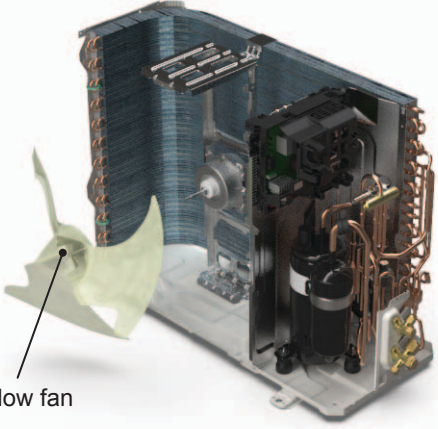

Step	Procedure
<p><b>4. Remove front panel assy</b></p>	<p>Remove connection screws connecting the front panel assy with the chassis and the motor support, and then remove the front panel assy.</p> 
<p><b>5. Remove right side plate assy</b></p>	<p>Rescrew the ground screws, remove the ground wires, loosen the screws fixing terminal board, remove the terminal board, rescrew the screws fixing the right plate, and remove the right side plate assy.</p> 
<p><b>6. Remove axial flow fan</b></p>	<p>Remove the nut on the fan and then remove the axial flow fan.</p> 

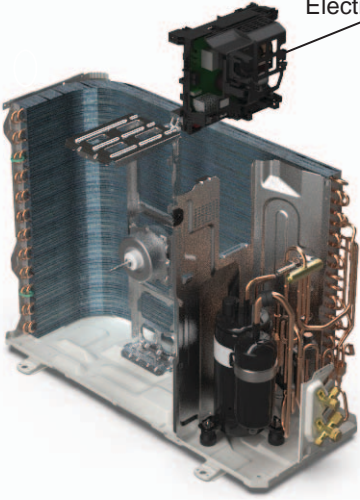
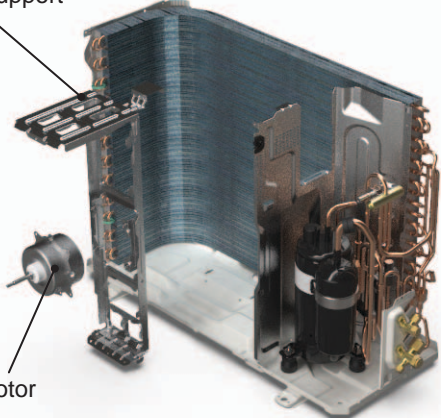
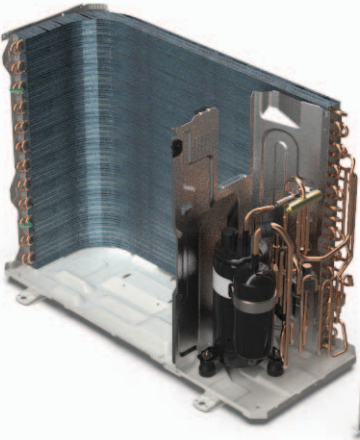

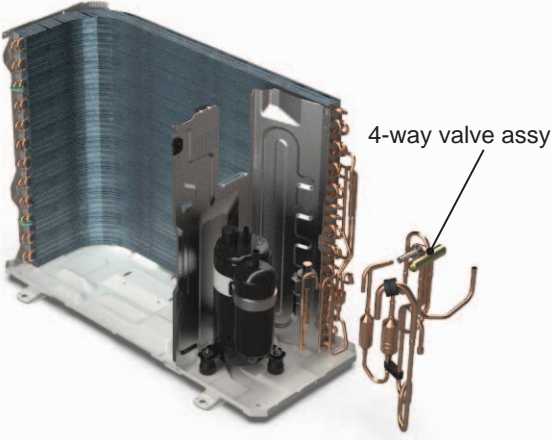
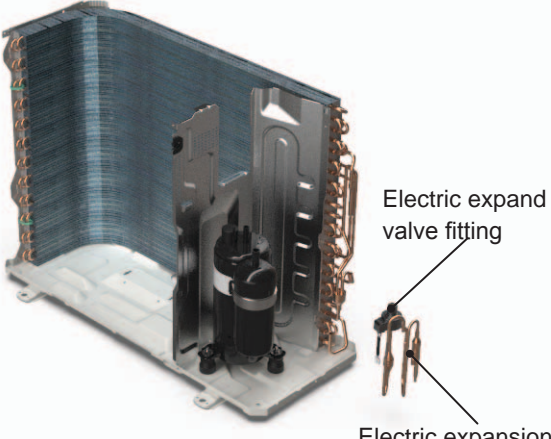
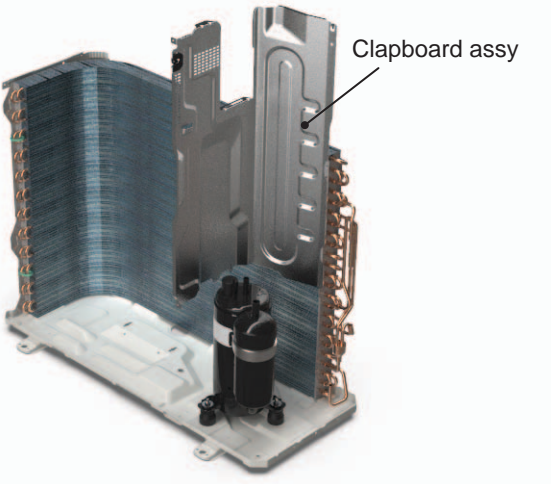
Step	Procedure
<p><b>7. Remove electric box assy</b></p>	<p>Remove the terminals, lift up and rotate the electrical box assy to the right so that the snaps on the clapboard are removed and the electrical box assy are removed.</p>  <p>Electric box assy</p>
<p><b>8. Remove motor and motor support</b></p>	<p>Remove the screws fixing the motor and then remove the motor. Remove the screws fixing the motor support and lift the motor support to remove it.</p>  <p>Motor support</p> <p>Motor</p>
<p><b>9. Remove gas valve, liquid valve and valve support</b></p>	<p>Remove the valve support block, remove the screws fixing the gas valve and the liquid valve, unsolder the welding joint connecting the gas valve and the liquid valve, remove them.</p> <p>Note: Discharge the refrigerant completely before unsoldering; when unsoldering, wrap the gas valve with a wet cloth completely to avoid damage to the valve caused by high temperature. Remove the screws fixing valve support, then remove the valve support.</p>  <p>Valve support</p> <p>Liquid valve</p> <p>gas valve</p>

Step	Procedure
<p><b>10. Remove 4-way valve assy</b></p> <p>Unsolder the welding joints connecting the 4-way valve assy, remove the 4-way valve.</p> <p>Note: Before unsoldering the welding joint, wrap the 4-way valve with a wet cloth completely to avoid damage to the valve caused by high temperature.</p>	 <p>4-way valve assy</p>
<p><b>11. Remove electric expansion valve sub-Assy</b></p> <p>Unsolder the spot weld of electric expansion valve sub-Assy and condenser, and then remove the electric expansion valve sub-Assy.</p> <p>Note: When unsoldering the spot weld, wrap the electric expansion valve sub-Assy with wet cloth completely to avoid damaging the valve due to high temperature.</p>	 <p>Electric expand valve fitting</p> <p>Electric expansion valve sub-Assy</p>
<p><b>12. Remove clapboard assy</b></p> <p>Remove the screws fixing the clapboard assy and then remove the clapboard assy.</p>	 <p>Clapboard assy</p>

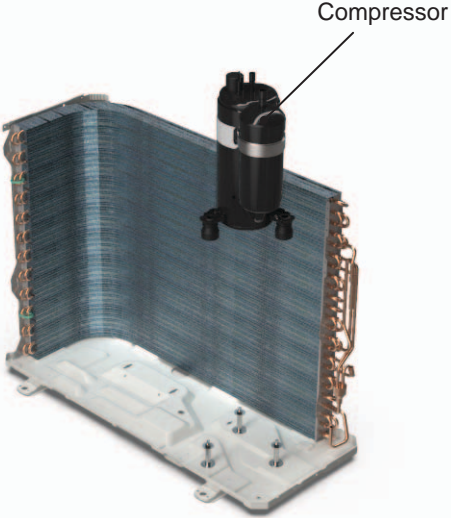

Step	Procedure
<b>13. Remove compressor</b>	<p data-bbox="191 530 787 591">Remove the 3 foot nuts on the compressor and then remove the compressor.</p> 

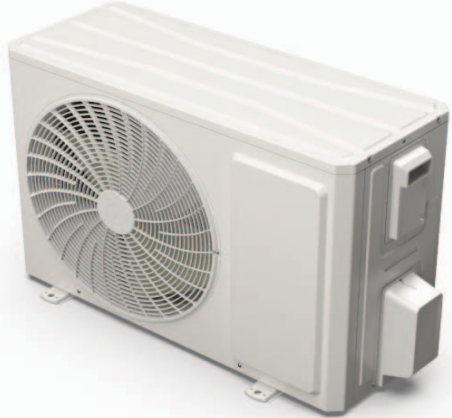
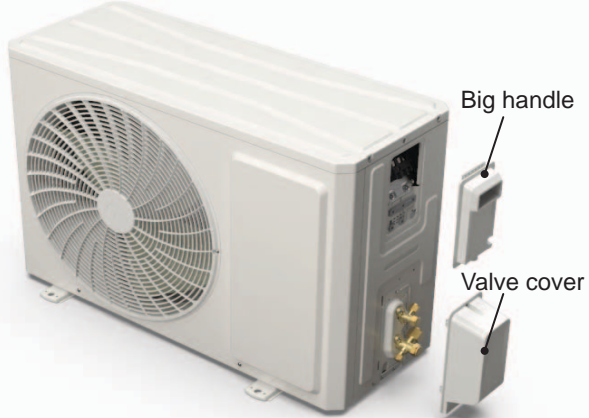
**Caution: discharge the refrigerant completely before removal.**

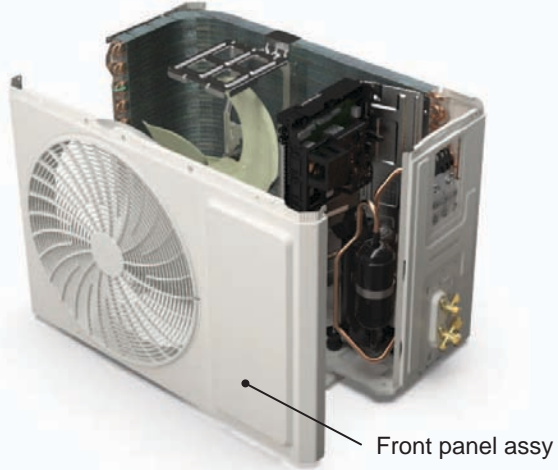
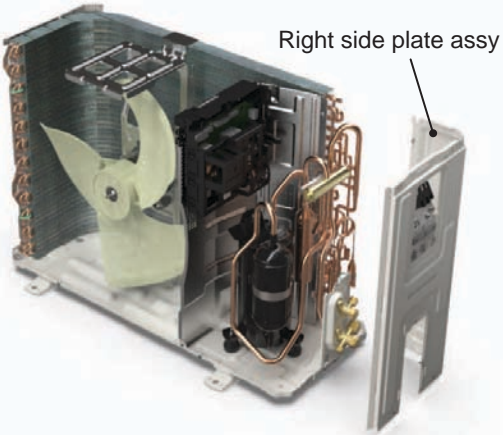
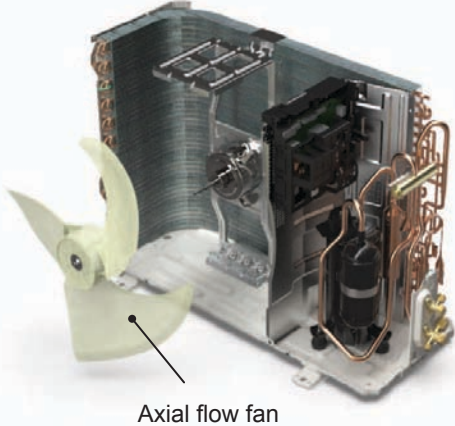

Step	Procedure
<b>1. Before disassembly</b>	
<b>2. Remove big handle and valve cover</b>	<p data-bbox="191 1148 789 1214">Remove the screws fixing big handle, valve cover and then remove them.</p> 
<b>3. Remove top cover</b>	<p data-bbox="191 1749 789 1814">Remove the screws fixing top panel and then remove the top panel.</p> 

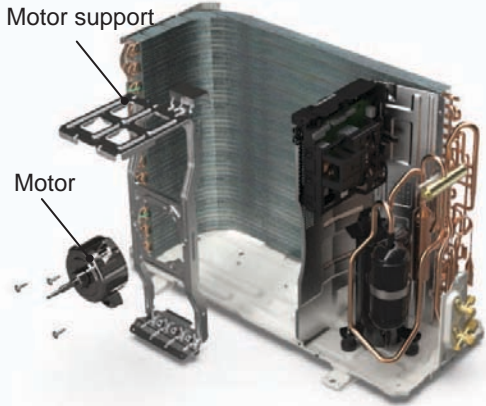
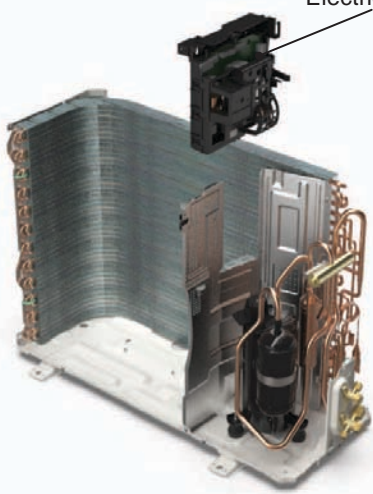
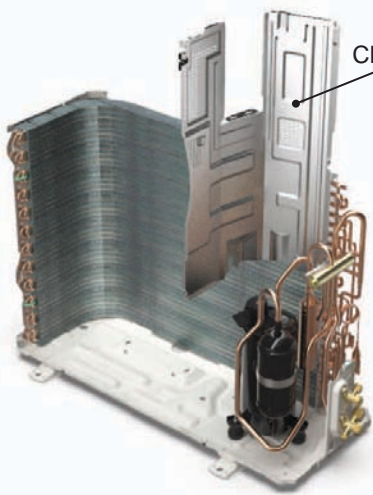
Step	Procedure
<p><b>4. Remove front panel assy</b></p>	<p>Remove connection screws connecting the front panel assy with the chassis and the motor support, and then remove the front panel assy.</p> 
<p><b>5. Remove right side plate assy</b></p>	<p>Rescrew the ground screws, remove the ground wires, loosen the screws fixing terminal board, remove the terminal board, rescrew the screws fixing the right plate, and remove the right side plate assy.</p> 
<p><b>6. Remove axial flow fan</b></p>	<p>Remove the nut on the fan and then remove the axial flow fan.</p> 

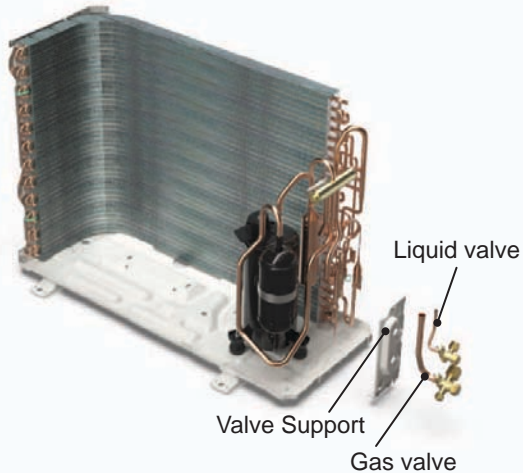
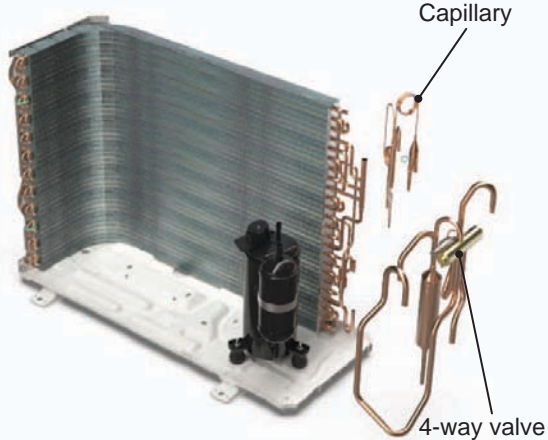
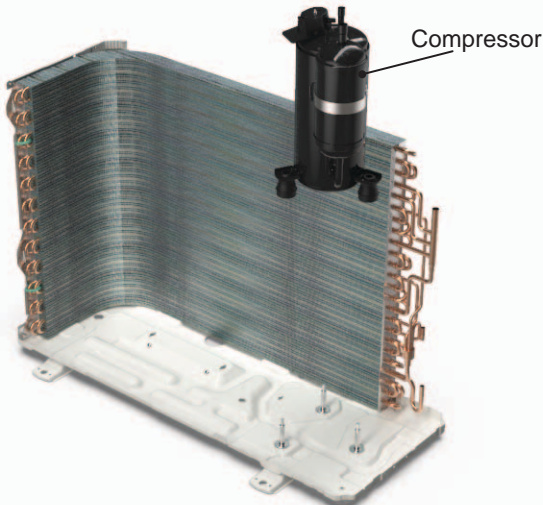
Step	Procedure
<p><b>7. Remove motor support and motor</b></p>	<p>Remove the screws fixing the motor support and lift the motor support to remove it. Remove the screws fixing the motor and then remove the motor.</p> 
<p><b>8. Remove electric box assy</b></p>	<p>Remove the terminals, lift up and rotate the electrical box assy to the right so that the snaps on the clapboard are removed and the electrical box assy are removed.</p> 
<p><b>9. Remove clapboard assy</b></p>	<p>Remove the screws fixing the clapboard assy and then remove the clapboard assy.</p> 



Step	Procedure
<p><b>10. Remove gas valve and liquid valve</b></p> <p>Remove the valve support block, remove the screws fixing the gas valve and the liquid valve, unsolder the welding joint connecting the gas valve and the liquid valve, remove them.</p> <p>Note: Discharge the refrigerant completely before unsoldering; when unsoldering, wrap the gas valve with a wet cloth completely to avoid damage to the valve caused by high temperature.</p>	 <p>The diagram illustrates the removal of the gas and liquid valves. A white valve support block is shown being detached from the evaporator coil. The gas valve and liquid valve are shown being removed from their respective ports on the coil. Labels point to the 'Valve Support', 'Gas valve', and 'Liquid valve'.</p>
<p><b>11. Remove 4-way valve and capillary</b></p> <p>Unsolder the welding joints connecting capillary, and then remove it.</p> <p>Unsolder the welding joints connecting the 4-way valve assembly with capillary sub-assembly, compressor and condenser; remove the 4-way valve. Cooling only unit removes Discharge Tube and Inhalation Tube.</p> <p>Note: Before unsoldering the welding joint, wrap the 4-way valve with a wet cloth completely to avoid damage to the valve caused by high temperature.</p>	 <p>The diagram shows the removal of the 4-way valve and capillary. The capillary tube is shown being disconnected from the evaporator coil. The 4-way valve is shown being removed from the compressor and condenser assembly. Labels point to the 'Capillary' and '4-way valve'.</p>
<p><b>12. Remove compressor</b></p> <p>Remove the 3 foot nuts on the compressor and then remove the compressor.</p>	 <p>The diagram illustrates the removal of the compressor. The compressor is shown being detached from the evaporator coil. A label points to the 'Compressor'.</p>

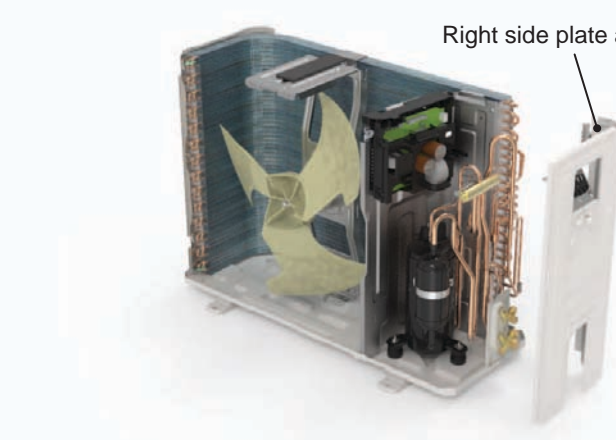
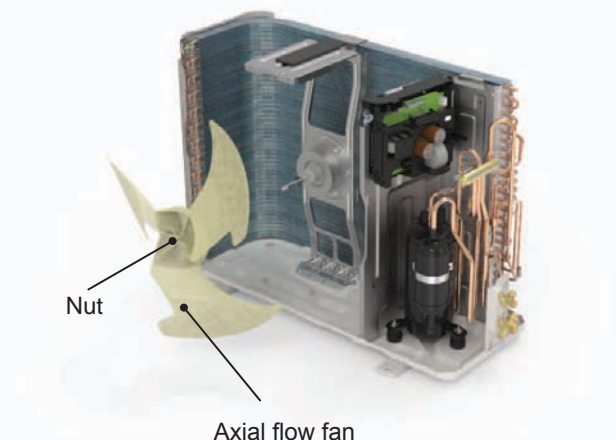

Step	Procedure
<p><b>1. Before disassembly</b></p>	
<p><b>2. Remove big handle and valve cover</b></p>	<p>Remove the screws fixing big handle, valve cover and then remove them.</p> 
<p><b>3. Remove top cover</b></p>	<p>Remove the screws fixing top panel and then remove the top panel.</p> 

Step	Procedure
<p><b>4. Remove front panel assy</b></p>	<p>Remove connection screws connecting the front panel assy with the chassis and the motor support, and then remove the front panel assy.</p> 
<p><b>5. Remove right side plate assy</b></p>	<p>Rescrew the ground screws, remove the ground wires, loosen the screws fixing terminal board, remove the terminal board, rescrew the screws fixing the right plate, and remove the right side plate assy.</p> 
<p><b>6. Remove axial flow fan</b></p>	<p>Remove the nut on the fan and then remove the axial flow fan.</p> 

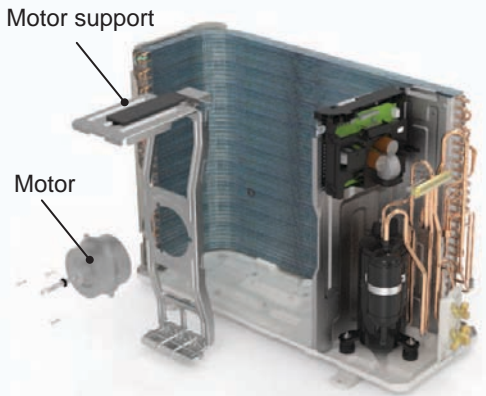

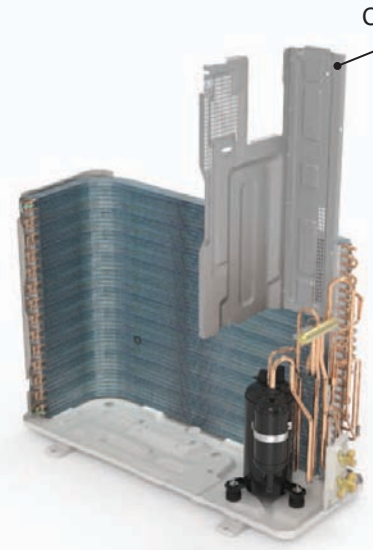
Step	Procedure
<p><b>7. Remove motor support and motor</b></p>	<p>Remove the screws fixing the motor support and lift the motor support to remove it. Remove the screws fixing the motor and then remove the motor.</p> 
<p><b>8. Remove electric box assy</b></p>	<p>Remove the terminals, lift up and rotate the electrical box assy to the right so that the snaps on the clapboard are removed and the electrical box assy are removed.</p> 
<p><b>9. Remove clapboard assy</b></p>	<p>Remove the screws fixing the clapboard assy and then remove the clapboard assy.</p> 

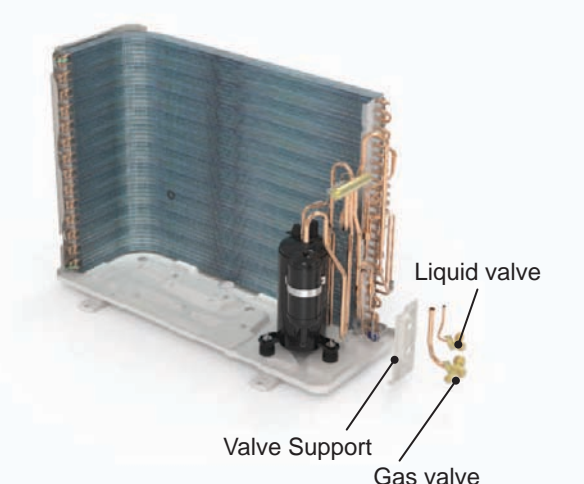
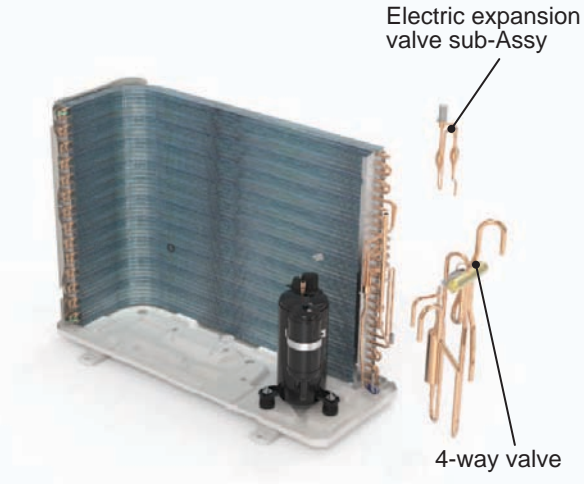
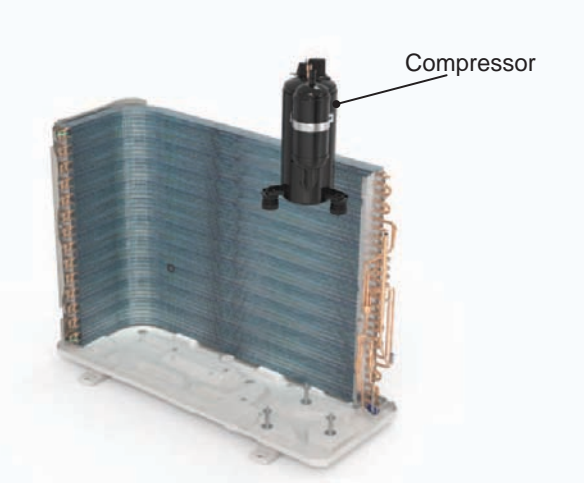
Step	Procedure
<p><b>10. Remove gas valve and liquid valve</b></p> <p>Remove the valve support block, remove the screws fixing the gas valve and the liquid valve, unsolder the welding joint connecting the gas valve and the liquid valve, remove them.</p> <p>Note: Discharge the refrigerant completely before unsoldering; when unsoldering, wrap the gas valve with a wet cloth completely to avoid damage to the valve caused by high temperature.</p>	 <p>The diagram shows a condenser coil assembly with a black valve support block. A gas valve and a liquid valve are connected to the coil. Labels with arrows point to the Valve Support, Gas valve, and Liquid valve.</p>
<p><b>11. Remove 4-way valve and electric expansion valve sub-Assy</b></p> <p>Unsolder the welding joints connecting the 4-way valve assy, remove the 4-way valve.</p> <p>Unsolder the spot weld of electric expansion valve sub-Assy and condenser, and then remove the electric expansion valve sub-Assy.</p> <p>Note: Before unsoldering the welding joint, wrap the 4-way valve with a wet cloth completely to avoid damage to the valve caused by high temperature. When unsoldering the spot weld, wrap the electric expansion valve sub-Assy with wet cloth completely to avoid damaging the valve due to high temperature.</p>	 <p>The diagram shows the condenser coil assembly with the 4-way valve and electric expansion valve sub-assembly removed. Labels with arrows point to the Electric expansion valve sub-Assy and the 4-way valve.</p>
<p><b>12. Remove compressor</b></p> <p>Remove the 3 foot nuts on the compressor and then remove the compressor.</p>	 <p>The diagram shows the condenser coil assembly with the compressor mounted on top. A label with an arrow points to the Compressor.</p>

# Appendix

## Appendix 1: Reference Sheet of Celsius and Fahrenheit

Conversion formula for Fahrenheit degree and Celsius degree:  $T_f = T_c \times 1.8 + 32$

### Set temperature

Fahrenheit display temperature (°F)	Fahrenheit (°F)	Celsius (°C)	Fahrenheit display temperature (°F)	Fahrenheit (°F)	Celsius (°C)	Fahrenheit display temperature (°F)	Fahrenheit (°F)	Celsius (°C)
61	60.8	16	69/70	69.8	21	78/79	78.8	26
62/63	62.6	17	71/72	71.6	22	80/81	80.6	27
64/65	64.4	18	73/74	73.4	23	82/83	82.4	28
66/67	66.2	19	75/76	75.2	24	84/85	84.2	29
68	68	20	77	77	25	86	86	30

### Ambient temperature

Fahrenheit display temperature (°F)	Fahrenheit (°F)	Celsius (°C)	Fahrenheit display temperature (°F)	Fahrenheit (°F)	Celsius (°C)	Fahrenheit display temperature (°F)	Fahrenheit (°F)	Celsius (°C)
32/33	32	0	55/56	55.4	13	79/80	78.8	26
34/35	33.8	1	57/58	57.2	14	81	80.6	27
36	35.6	2	59/60	59	15	82/83	82.4	28
37/38	37.4	3	61/62	60.8	16	84/85	84.2	29
39/40	39.2	4	63	62.6	17	86/87	86	30
41/42	41	5	64/65	64.4	18	88/89	87.8	31
43/44	42.8	6	66/67	66.2	19	90	89.6	32
45	44.6	7	68/69	68	20	91/92	91.4	33
46/47	46.4	8	70/71	69.8	21	93/94	93.2	34
48/49	48.2	9	72	71.6	22	95/96	95	35
50/51	50	10	73/74	73.4	23	97/98	96.8	36
52/53	51.8	11	75/76	75.2	24	99	98.6	37
54	53.6	12	77/78	77	25			

## Appendix 2: Configuration of Connection Pipe

- Standard length of connection pipe (More details please refer to the specifications.)
- Min length of connection pipe For the unit with standard connection pipe of 5m, there is no limitation for the min length of connection pipe. For the unit with standard connection pipe of 7.5m and 8m, the min length of connection pipe is 3m.
- Max. length of connection pipe and max. high difference. (More details please refer to the specifications.)
- The additional refrigerant oil and refrigerant charging required after prolonging connection pipe
  - After the length of connection pipe is prolonged for 10m at the basis of standard length, you should add 5ml of refrigerant oil for each additional 5m of connection pipe.
  - The calculation method of additional refrigerant charging amount (on the basis of liquid pipe):
  - Basing on the length of standard pipe, add refrigerant according to the requirement as shown in the table. The additional refrigerant charging amount per meter is different according to the diameter of liquid pipe. See the following sheet.
  - Additional refrigerant charging amount = prolonged length of liquid pipe X additional refrigerant charging amount per meter.

Additional refrigerant charging amount for R32

Piping size		Indoor unit throttle	Outdoor unit throttle	
Liquid pipe	Gas pipe	Cooling only, cooling and heating (g / m)	Cooling only(g/m)	Cooling and heating(g/m)
1/4"	3/8" or 1/2"	14	12	16
1/4" or 3/8"	5/8" or 3/4"	40	12	40
1/2"	3/4" or 7/8"	80	24	96
5/8"	1" or 1 1/4"	136	48	96
3/4"	/	200	200	200
7/8"	/	280	280	280

## Appendix 3: Pipe Expanding Method

### ⚠ Note:

Improper pipe expanding is the main cause of refrigerant leakage. Please expand the pipe according to the following steps:

#### A: Cut the pipe

- Confirm the pipe length according to the distance of indoor unit and outdoor unit.
- Cut the required pipe with pipe cutter.

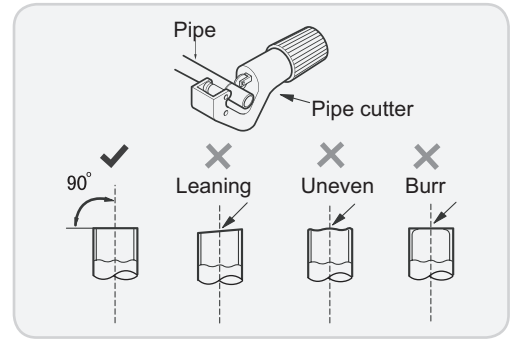

#### B: Remove the burrs

- Remove the burrs with shaper and prevent the burrs from getting into the pipe.

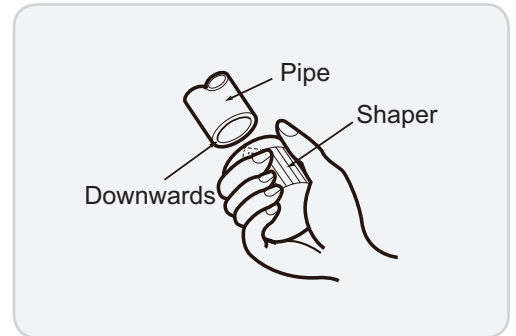

#### C: Put on suitable insulating pipe.

#### D: Put on the union nut

- Remove the union nut on the indoor connection pipe and outdoor valve; install the union nut on the pipe.

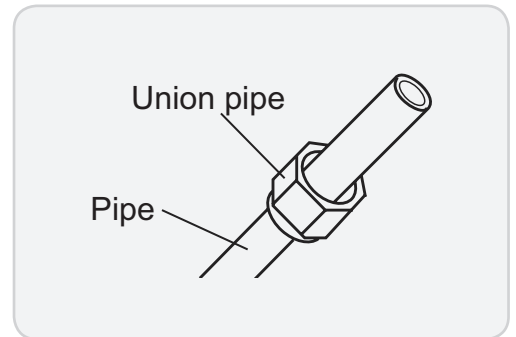

#### E: Expand the port

- Expand the port with expander.

### ⚠ Note:

- "A" is different according to the diameter, please refer to the sheet below:

Outer diameter(mm)	A(mm)	
	Max	Min
Φ6 - 6.35 (1/4")	1.3	0.7
Φ9 - Φ9.52 (3/8")	1.6	1.0
Φ12 - 12.70 (1/2")	1.8	1.0
Φ16 - 15.88 (5/8")	2.4	2.2

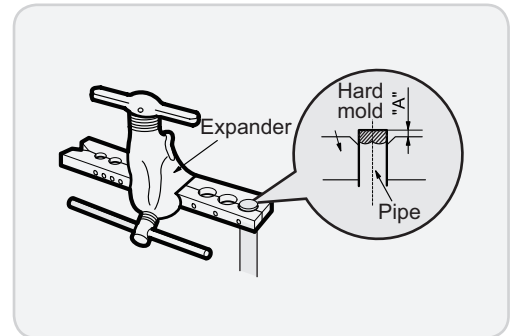

#### F: Inspection

- Check the quality of expanding port. If there is any blemish, expand the port again according to the steps above.

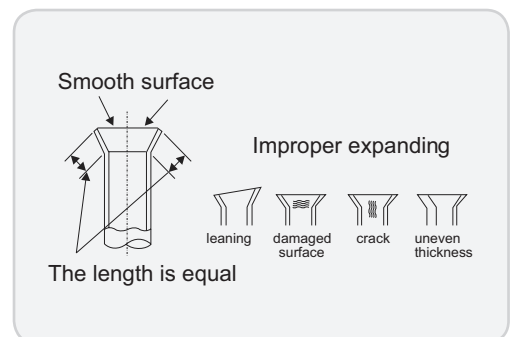

## Appendix 4: List of Resistance for Temperature Sensor

### Resistance Table of Ambient Temperature Sensor for Indoor and Outdoor Units(15K)

Temp(°C)	Resistance(kΩ)
-19	138.10
-18	128.60
-16	115.00
-14	102.90
-12	92.22
-10	82.75
-8	74.35
-6	66.88
-4	60.23
-2	54.31

Temp(°C)	Resistance(kΩ)
0	49.02
2	44.31
4	40.09
6	36.32
8	32.94
10	29.90
12	27.18
14	24.73
16	22.53
18	20.54

Temp(°C)	Resistance(kΩ)
20	18.75
22	17.14
24	15.68
26	14.36
28	13.16
30	12.07
32	11.09
34	10.20
36	9.38
38	8.64

Temp(°C)	Resistance(kΩ)
40	7.97
42	7.35
44	6.79
46	6.28
48	5.81
50	5.38
52	4.99
54	4.63
56	4.29
58	3.99

### Resistance Table of Tube Temperature Sensors for Indoor and Outdoor (20K)

Temp(°C)	Resistance(kΩ)
-19	181.40
-15	145.00
-10	110.30
-5	84.61
0	65.37
5	50.87
10	39.87
15	31.47

Temp(°C)	Resistance(kΩ)
20	25.01
25	20.00
30	16.10
35	13.04
40	10.62
45	8.71
50	7.17
55	5.94

Temp(°C)	Resistance(kΩ)
60	4.95
65	4.14
70	3.48
75	2.94
80	2.50
85	2.13
90	1.82
95	1.56

Temp(°C)	Resistance(kΩ)
100	1.35
105	1.16
110	1.01
115	0.88
120	0.77
125	0.67
130	0.59
135	0.52

### Resistance Table of Discharge Temperature Sensor for Outdoor(50K)

Temp(°C)	Resistance(kΩ)
-30	911.400
-25	660.8
-20	486.5
-15	362.9
-10	274
-5	209
0	161
5	125.1

Temp(°C)	Resistance(kΩ)
10	98
15	77.35
20	61.48
25	49.19
30	39.61
35	32.09
40	26.15
45	21.43

Temp(°C)	Resistance(kΩ)
50	17.65
55	14.62
60	12.17
65	10.18
70	8.555
75	7.224
80	6.129
85	5.222

Temp(°C)	Resistance(kΩ)
90	4.469
95	3.841
100	3.315
105	2.872
110	2.498
115	2.182
120	1.912
125	1.682



JF00304644



GREE ELECTRIC APPLIANCES, INC. OF ZHUHAI

Add: West Jinji Rd, Qianshan, Zhuhai, Guangdong, China, 519070

Tel: (+86-756) 8522219

Fax: (+86-756) 8669426

E-mail: [global@cn.gree.com](mailto:global@cn.gree.com)

**For product improvement, specifications and appearance in this manual are subject to change without prior notice.**